



**Relaxation
has Found its
ultimate expression**

SPA & SWIM SPA



Version:SR-2304-SPA



COMPANY PROFILE

Located in China, is the Top-3 manufacturer which has more than 15 years experience in wellness industry.

Since its foundation in 2006, attaches much importance on product research and development. Now it has become a famous brand which specializes in following 7 different series of product: Outdoor Spa, Swim Pool Spa, Indoor Massage Bathtub, Steam Shower, Shower Enclosure, Sauna Room, Infrared Sauna Etc. There are more than 400 items to meet the various needs of customers. Customized operation is also acceptable.

In strict accordance with international standards, produces high-end quality wellness products with CE, ROHS, KC, ETL, SAA Approval, as well as ISO9001 Quality management System. Currently, the main markets are: Europe, North America, Southeast Asia, Australia, the Middle East etc. We have been building up great business relationship with more than 50 countries like Norway, Belgium, France, Germany, UK, Spain, USA, Australia, India, Singapore, Israel, UAE etc.

We hope to be serving to the customers with more excellent quality, hand in hand develop and benefit together mutually. This is our consistent target.



In five minutes you will lose yourself, Twenty minutes later you'll put the world all behind you.

The Famous American Author Mark Twain



QUALITY ASSURANCE

In strict accordance with international standards, produces high-end quality wellness products with CE, ROHS, KC, ETL, SAA Approval, as well as ISO9001 Quality management System.

INTERNATIONAL
CERTIFICATION
ISO 9001

CE

RoHS
Compliant

SA

TUV
SUD

ETL

KC

SAA

SGS

UL

UL

UL

SCIENTIFIC LAYOUT AND EXQUISITE ASSEMBLY TECHNOLOGY



● Base

The base is a sealed bottom which install on the spa bottom. With a solid sealed fiberglass forever floor(Or ABS floor), it can stop insects and pests, damp and long-term structural problems. It also allows the spa(hot tub) to be placed anywhere that's level (without any ground preparation) giving total portability.

METALLIC STRUCTURE

All Sunrans spas are equipped with a robust metal structure(#304 stainless steel) that prolongs their service life. Given a rustproof treatment, this metal structure not only supports the weight of a spa over the years but is also able to withstand humid environments and resist the passage of time, even if installed outdoors.

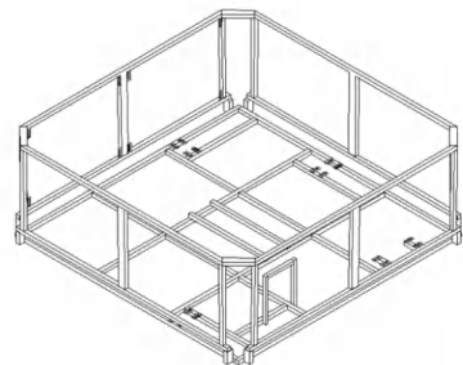

● Power line Layout

The Strong and weak electricity are isolated to make sure the SPA is 100% safe. Also all weak electrical elements are installed on the integrated plate for easier maintenance.

● Cabinet

The premium maintenance-free cabinetry for lasting good looks. With a realistic wood-look finish and a modern design, you can have the beauty of wood without the work.



● Air blower(option)

Spa Air Blower feature revolutionary turbo design for more air output using less power. Silent air motor runs cool and quiet.

As an added feature, all Sunrans Spas can be equipped with Therapy Air also come with a fully integrated aromatherapy system that introduces fragrance directly into the spa! The power of natural scent both refreshes and relaxes, complimenting a totally therapeutic soak.

● Water massage pump

Perfect match with Sunrans SPA & swim spas.

Large flow volute design with 2inch inlet and outlet. And 4 locations available for pump housing installation.

Single phase motor installation T1 thermal protector.

Motor adopts high temperature resistant bearing that be long life, reliable and durable.

Liquid absolutely separate with shaft to keep safer and more reliable.

Insulation class F, protection IPx5.

CE, TUV, SAA, KC, ETL certification approval.



● Circulation pump

We choose the high quality, long-life, extremely quiet circulation pump. This pump is rated for continuous duty operation, features an integrated mounting bracket;



MASSAGE DESIGNED FOR EACH PART OF YOUR BODY



THERAPY FOR BODY AND SOUL

Ergonomically designed using therapeutic principles, each spa fits the contours of your body providing proper lumbar support and maximizing comfort while the jets melt away stress and muscle strain. When you are in the Spa, many points on your body will experience the wonderful effects of water massage. Extraordinary comfort will come to your entire body.

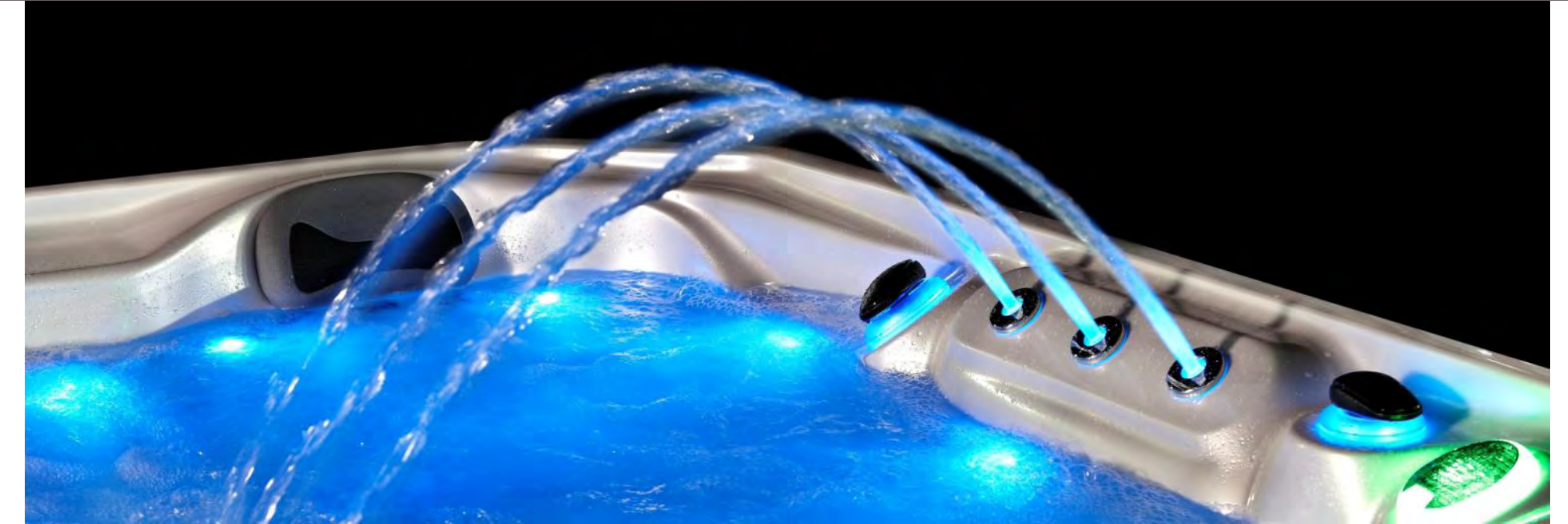

Neck Massage



Our exclusive reverse molded neck jet seat features a ledge with specially designed jets that are trained downward putting your neck and shoulders under the jets for the ultimate tension-relieving massage. Simply put, it's Stress Relief for the areas that need it the most.

Foot massage



Foot massage help soothe muscle and joint pain. This type of massage gives a pleasant, relaxing feeling, and helps you get a good night's sleep.

Leg massage



The lounge offers a water massage pattern special for leg muscles, which could effective ease soreness, pain or discomfort.

Direct massage



The direct-jets offer high pressure water massage. The water gives a continuous high pressure massage on any part of the body you choose to relieve aches and pains.

Rotating massage



Impact-based water massage. It also gives a lipo active and firming massage of the body in beauty treatments

water massage jets with LED



We offer optional premium water massage jets with LED. It greatly enhance the chromotherapy. It makes your spa look stunning as the water can be made to appear any colour under the sun.

PROVIDE MULTIPLE HEAT PRESERVATION SOLUTION

The spa equipment is oriented so that any heat generated is recycled, keeping the spa water warm. You'll save money because heat and electricity are conserved.

Spa Cover

We offer an insulating hard cover to keep the heat in and save on utility bills. Our built-to-last spa covers are constructed with heavy-duty marine grade vinyl, high-density foam and Heavy aluminium alloy frame reinforcement.

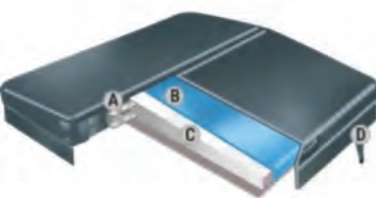

LONGEVITY&INSULATION FEATURES

- A. Heavy aluminium alloy frame reinforcement- prevents cover sagging
- B. 6 Mil ZEROTex moisture barrier-maintains core R-value
- C. Premium aquatic-grade insulation-for maximum heat retention and strength
- D. Heavy-duty windstraps(no extra charge)-secure cover & prevent heat leakage
- E. Multi-ply poly laminate underside(no extra charge)-For superior durability.
- F. Double-wrapped core option-For maximum water penetration protection.
- G. Energy Reflex thermal mirror option -Locks in radiant heat , pays for itself.
- H. Full-length Heat Seal option -Eliminates center hinge heat loss .

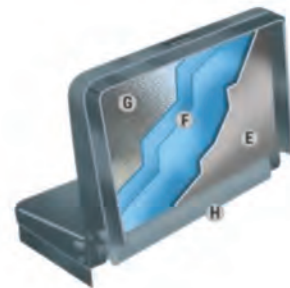

Skirt Insulation

Reflective foil-backed foam panels keep warm air circulating inside the spa cabinets similar to the insulation in your attic. Without the messy spray foam, you can easily access the internal components of your hot tub.



Pipe insulation

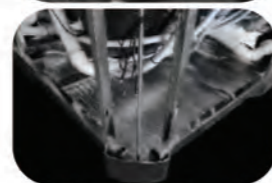

Base insulation

The base of the spa, (ABS Base Pan), boosts energy efficiency by minimizing contact with the ground preventing moisture wicking.



Shell insulation



CHROMO-THERAPY

A SPA can help you unwind, relax, and even help you sleep.

The heat expands blood vessels, improves circulation, and reduces pain.

The addition of hydromassage (the massaging pressure from the jets)

can relieve muscle tension

and help you de-stress even more. Immersing

yourself in a hot tub for even 10 minutes

has plenty of benefits



Putting Spa Therapy In A Whole New Light



Our optional LED lighting package is an industry first. Brighter and more reliable than fiber optic, LED lighting is now used in vehicle taillights and traffic signals and will last up to 10 years.

Spas really shine at night with our underwater lighting. The jets, waterfall, fountains, water regulator and more. At the touch of a button, flood your tub with color and create the perfect atmosphere for a night-time soak.



AUDIO BLUETOOTH SOUND SYSTEM

All of our portable spas & Swim Spas can be equipped with a full sound system.

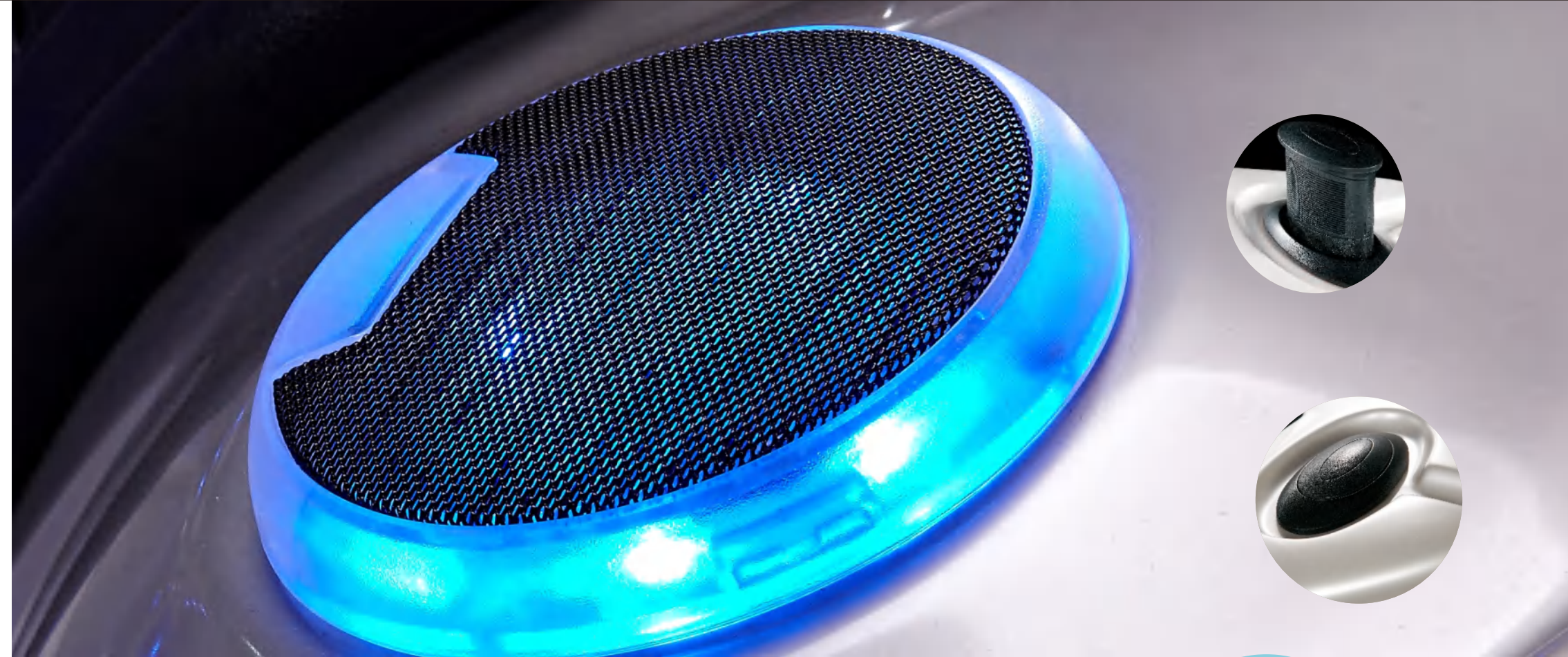

SCIENCE & TECHNOLOGY . FASHION. HEALTHY. INTELLIGENCE.

The premium sound system option features Bluetooth streaming audio, two full range marine grade high fidelity speakers a powerful hidden subwoofer and 150W audio amplifier with variable crossover. Just pair your smart phone to stream music wirelessly.

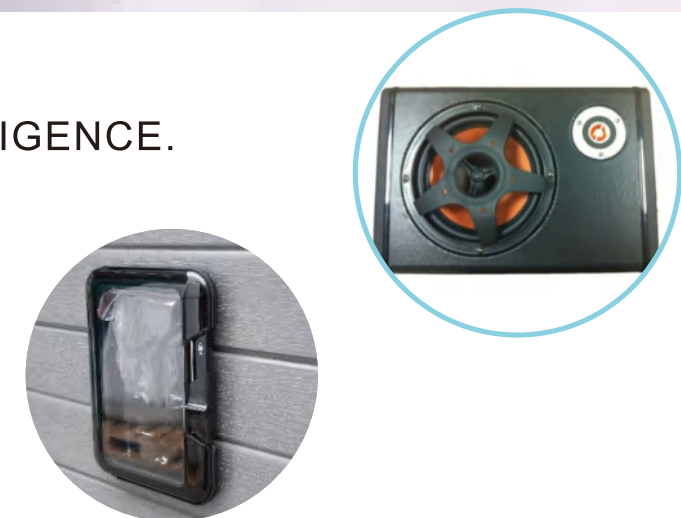

SMART CONTROL COLLECTION

All SPAs are equipped with Balboa control system from economic models to high-end models like TP800 or Touch panel. Also you can choose to update the system to Smartphone control then you can access the control system of your spa anytime from anywhere with your Smartphone.

iPhone and iPad are registered trademarks of Apple Inc.
Android is a trademark of Google Inc.



CONTROL YOUR TUB
Anytime Anywhere Anyplace

CONTROL YOUR SPA

- In Your Backyard
- In Your House
- In Your Office
- Any Wi-Fi Hotspot
- Any 3G/4G Data Network

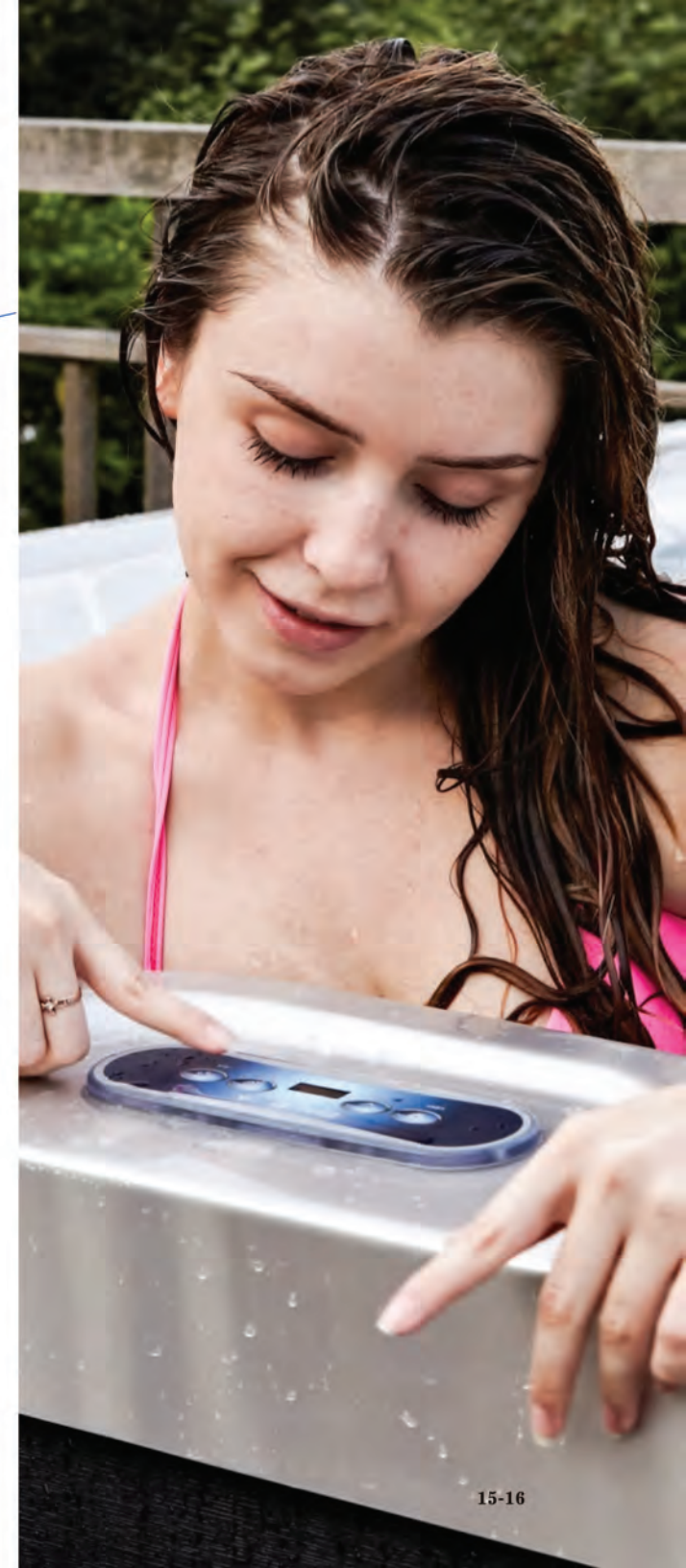
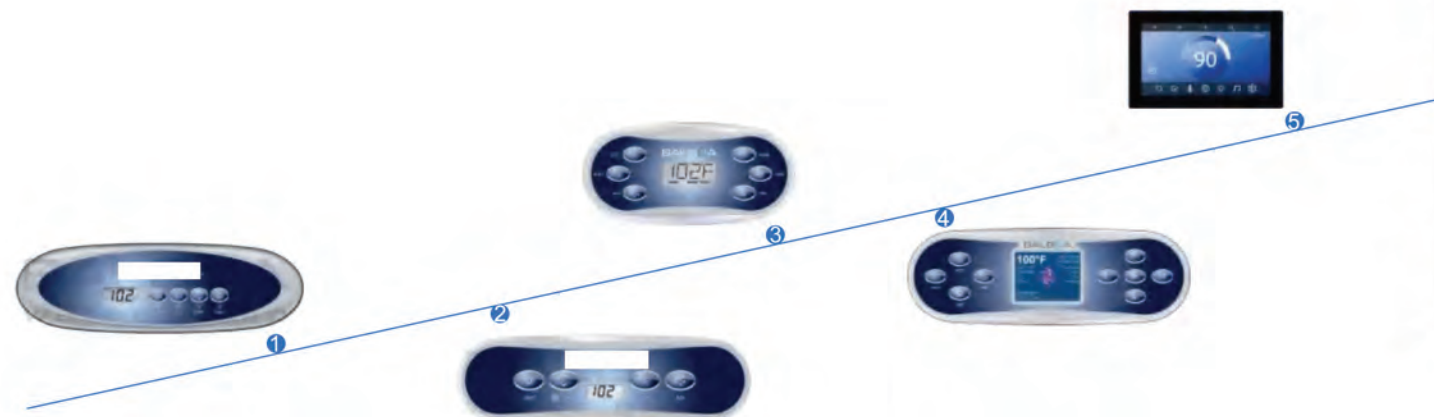

AIR THERAPY & AROMATHERAPY

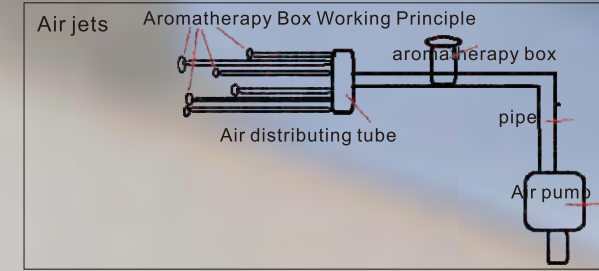

Our Air Therapy is designed to enhance your massage experience. Air is circulated through the water giving a gentler massage. As an added feature, all Sunrains Spas can be equipped with Air Therapy also come with a fully integrated aromatherapy system that introduces fragrance directly into the spa. The power of natural scent both refreshes and relaxes complimenting a totally therapeutic soak.

SELF-CLEANING SYSTEM

We use the best polyester filtration media that money can buy. The result is longer filter life and better water quality. In fact, you can expect up to 30% better filtration than some other brands which may look about the same, but use cheap filter media. An added bonus:

Our sharp pleat folds increase water flow rates while making cartridge cleaning easier.

NOTE: A sanitizer is still required to maintain spa water quality.

Antimicrobial End Caps & Premium Center Cores

Clarathon's reinforced end caps feature Antimicrobial protection from bacteria and mold. This protection greatly prolongs the life of the cartridge structure and works to inhibit odor and filter clogging, for a healthier filtration system.



find your filter
fast

IN CLEAR
water so clear.

Features

- Stress therapy:** benefits from relaxing and unwinding in clear, clean, soft and warm spa water
- Body therapy:** liquid massages and in-spa stretching for sore muscle relief
- Healthy habit:** clear, clean, soft and warm spa water contributes positively to your health
- Thermal workout:** a healthy bathing experience every time you use your spa
- Sleep therapy:** nightly soakings improve the quality of your sleep
- Skin therapy:** through natural cleansing of spa massages



Automatic generation of bromine

Water stays clean even if spa is not used for weeks.
Adjusts to circulation and filtration activation times and shut offs.



Free of harsh chemicals

Water stays clean even if spa is not used for weeks.
Adjusts to circulation and filtration activation times and shut offs.



Easy adjuster(maintenance mode)

Water stays clean even if spa is not used for weeks.
Adjusts to circulation and filtration activation times and shut offs.



Automatic generation of bromine

Water stays clean even if spa is not used for weeks.
Adjusts to circulation and filtration activation times and shut offs.



Automatic generation of bromine

Water stays clean even if spa is not used for weeks.
Adjusts to circulation and filtration activation times and shut offs.



Easy adjuster(maintenance mode)

Water stays clean even if spa is not used for weeks.
Adjusts to circulation and filtration activation times and shut offs.



CIRCULATION DISINFECTION SYSTEM

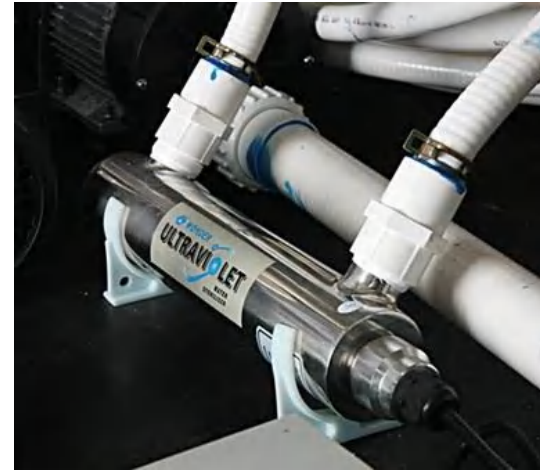

UV Sterilizer

Ultraviolet disinfection system can sterilize water in an effective and efficient way. Heating and addition of harmful chemicals do not needed. There is no abnormal flavor in the water after treatment. Different from Chlorine, Chlorine Dioxide, Ozone, and other chemical disinfection, ultraviolet disinfection is a physical process.

The advantages of the ultraviolet:

1. Ultraviolet disinfection technology is very effective in destroying bacteria.
2. Efficient disinfection
3. No secondary pollution
4. Low operational costs, simple operation and maintenance, and low costs.

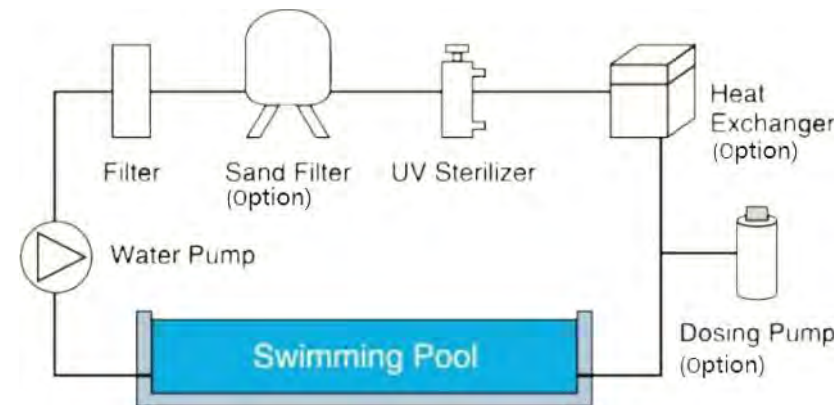

Ozone Premium



Spa Ozone System

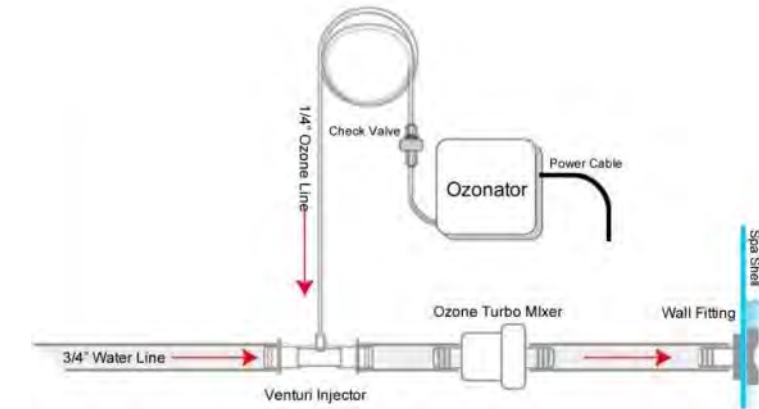

Ozone Standard

This ozonator is the best product you'll find for cleaning your spa and keeping it fresh day after day. The Spa Ozonator utilizes a Corona Discharge micro-ozone cell which is as close to nature's way of keeping your residential spa clean. Our proven ozone technology effectively removes water impurities and microorganisms, reduced chemical usage and requires less maintenance. Your skin will feel soft, clean and free of harsh chemicals the immediate changes and significant benefits include green technology.

Ozone Premium

You may update the standard Ozone to Premium Aqua Sun Ozone. Aqua Sun Ozone's Corona Discharge micro-ozone cell provides consistent ozone output with less heat, less energy usage and less nitric acid. There are no cartridges chips or bulbs to replace and it's great for our environment...you're going to love it!



MicroSilk® Oxygen Therapy

Use MicroSilk® for just 20 minutes a day to make you feel better and look younger.

MicroSilk® is a new patented Hydrotherapy that rejuvenates your body and skin, making you look younger and feel better. The gentle effervescent sensation and silky feel of the water are signs that your body is benefiting from the super saturated water with billions of oxygen-rich micro bubbles. These micro-bubbles, increase oxygen levels in the water and blankets your body, energizing skin cells, stimulating the immune system and collagen production killing bacteria and promoting healing.

Rejuvenate yourself with MicroSilk® – Hydrate your body, . Plump your skin, Reduce fine lines and wrinkles.

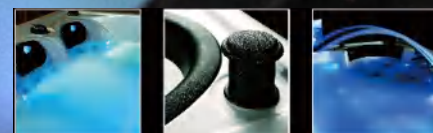

Timeless Beauty
MicroSilk® for spas

Timeless Beauty

MicroSilk® for spas
EXCLUSIVELY FROM BALBOA



Features

SMOOTH YOUR SKIN

Using MicroSilk® is like giving your entire body a trendy oxygen facial, moisturizing and hydrating at the same time. Plumping your skin, making it smoother.

STAY YOUNG. REDUCE WRINKLES

The MicroSilk® bubbles, makes your skin feel luxuriously silky as well as reducing fine lines and wrinkles.

RELAXING, SOOTHING SENSATIONS.

MicroSilk® Micro-bubbles literally envelope your body in a soothing, effervescent cloud of oxygen which results in better circulation and cellular respiration; that makes your body feel glowing and radiant due to better

ENHANCE COLLAGEN PRODUCTION.

MicroSilk® increases the levels of oxygen in the water which is good for your skin. Oxygen is known to stimulate natural collagen production, Nature's own anti-aging cream.

POOL

Relax Slowly Life

When the demands of your everyday working and private life get in the way of health and relaxation, there is little time to find a healthy balance.

The calming effect of warm water helps you to fall asleep at night.



Endless Swim Pool Spa
Welcome You to the World of Ultimate Relaxation

SR-859 SPECIFICATION

Size: 8100x2200x1400MM

SPA part	Swimming part
Seating Capacity: 6 Persons	Seating Capacity: 0
Lounge: 4 Person	Persons Lounge: 2 Persons

Dimensions/Weight/ Container load	
Product dimension	4000mmx2200mmx950/1400mm
	4100mmx2200mmx1400mm
Packing dimension	4100*2300*1500mm
	4200mmx2300mmx1500mm
Weight	1650KG
Water capacity	3300 US Gallon/ 12500Liters
Container load	0pc/ 20GP; 1pc/ 40ft

Shell	
Shell colors	10 color available
Shell material	Aristech Acrylic

Pumps--SPA Part (UL, CE, KC approved)	Pumps--Pool Part (UL, CE, KC approved)
Jet pump 1: 3.0HP	Jet pump 1: 3.0HP
Jet pump 2: 2.0HP	Jet pump 2: 3.0HP
Jet pump 3: 2.0HP	Jet pump 3: 3.0HP
Jet pump 4: 2.0HP	Jet pump 4: 2.0HP
Jet pump 5: 2.0HP	Jet pump 5: 2.0HP
Circulation pump: 1HP	Circulation pump: 1HP
Air blower: 1.5HP	Air blower: no

Electrics--SPA Part	Electrics--Swimming Part
Control system:	Control system:
America Balboa control	America Balboa control
Max power consumption:	Max power consumption:
13225 Watt 20.1A in 380V 50Hz	13600 Watt 20.6A in 380V 50Hz
Heater: 3KW/220-240VAC	Heater: 3KW/220-240VAC
Underwater lighting: 5* LED	Underwater lighting: 5* LED

Jet --SPA Part	Jet --Swimming Part
Jets total (pc): 151	Jets total (pc): 41
Massage jets (pc): 133	Massage jets (pc): 39
	Super size U shape swim jet with led (pc): 2
Air jets (pc): 18	Air jets (pc): 0

Filtration	
Filter	Front access filters
Effective Filtration Area	100 sq. ft.
Ozone Generator	200mg/h

Features	
Water diverter(pc): 6	Water diverter(pc): 4
Air regulator(pc): 2	Air regulator(pc): 6
Suctions (pc): 6	Suctions (pc): 6
Drain valve (pc): 1	Drain valve (pc): 1
Headrest pillows(pc): 7	Headrest pillows(pc): 2
Support frame	#304 Stainless steel
Overflow outlet (pc):	2
Skirt:	Brown/ Grey / Black color



*Handcrafted,
individually designed,*

precision engineered. Discover our extensive range of spas...



SR-8801B SPECIFICATION

Size 4500x2250x1500MM

Seating	
Seating Capacity	3 Persons
Lounge	0 Persons

Dimensions/Weight/ Container load	
Product dimension	4500mmx2250mmx1500mm
Packing dimension	4600mmx2350mmx1600mm
Weight - Dry/Filled	810KG/7310KG
Water capacity	1717 US Gallon/ 6500Liters
Container load	1pc/20ft; 2pcs/40ft

Shell	
Shell colors	6 color available
Shell material	Aristech Acrylic

Pumps(UL,CE,KC approved)	
Swim pump	3.0HPx3pcs
Jet pump	3.0HPx1pcs
Circulation pump	1.0HP

Electrics	
Control system	America Balboa control
Max power consumption:	12750Watt18.5Ain380V50Hz
Heater(America Balboa brand)	3KW/220-240VAC
Underwater lighting	5" LED

Jet Configurations	
Jets total (pc)	21
Super size U shape swim jets(pc)	3
5" Massage jets(pc)	7
3.5" Massage jets(pc)	7
2" Massage jets (pc)	4

Filtration	
High-efficiency Filter	Top mount filters (4filters)
Effective Filtration Area	200 sq. ft.
Ozone Generator	200mg/h

Others	
Fountain with LED(pc)	N/A
Water diverter(pc)	1
Air regulator(pc)	1
Suctions (pc)	10
Gate valves(pc)	2
Drain valve(pc)	1
Headrest pillows(pc)	2
Support frame	#304 Stainless steel
Overflow outlet (pc)	1
Skirt	H19, H03, H06 available
Handrail (pc)	3
ABS base	1



A SWIMMING POOL
MADE WITH THE BEST
VISUAL DESIGN

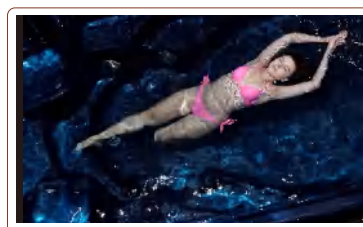
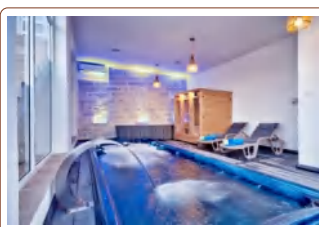

*Relax
Slowly Life*



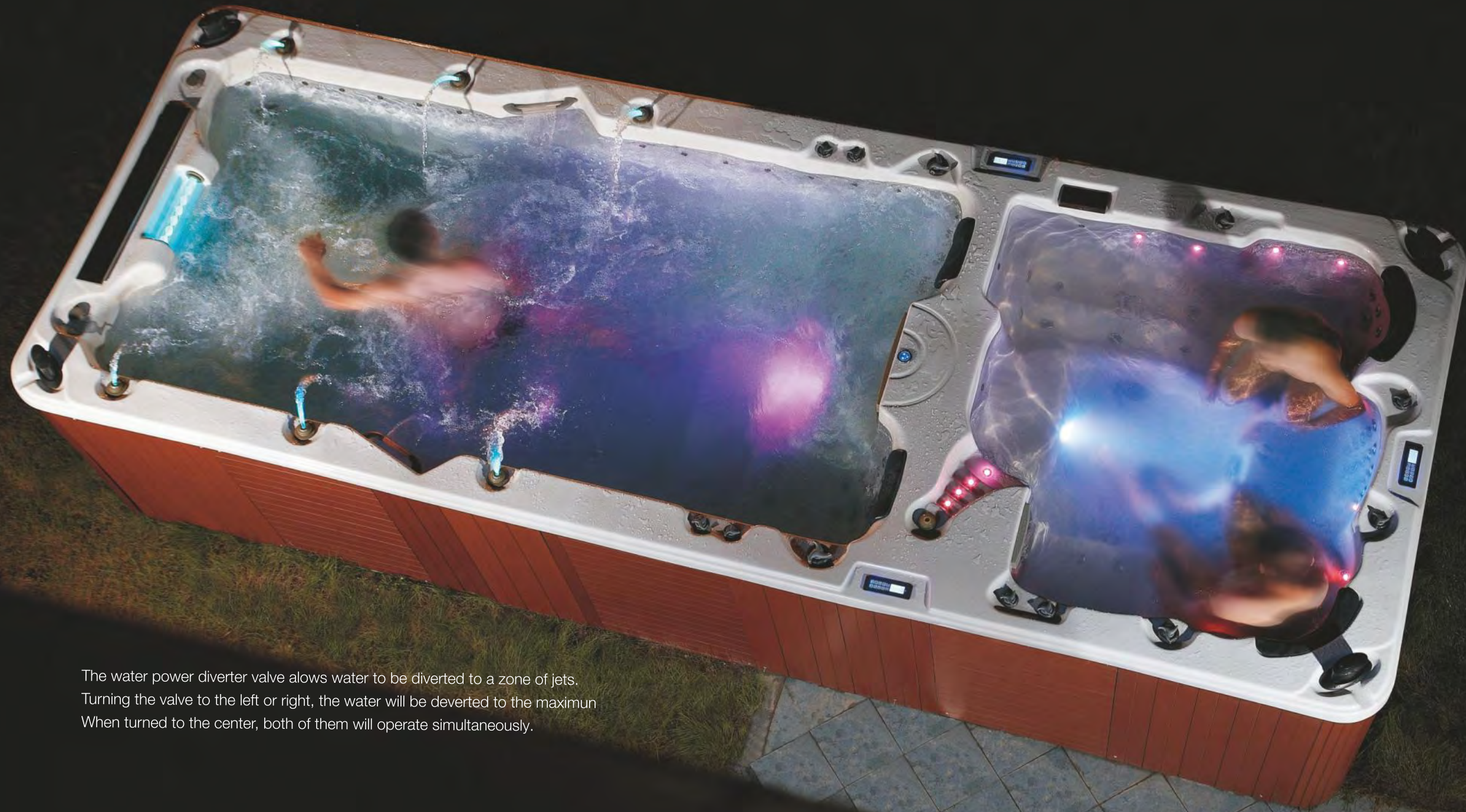

The water power diverter valve allows water to be diverted to a zone of jets.
Turning the valve to the left or right, the water will be diverted to the maximum
When turned to the center, both of them will operate simultaneously.

SR-850 SPECIFICATION

Size: 5850x2200x1300MM

SPA part Seating Capacity:3 Persons Lounge:1 Person	Swimming part Seating Capacity:0 Persons Lounge:2 Person
Dimensions/Weight/ Container load "SPA part:2200mmx1700mmx1300mm" Packing dimension Weight-Dry/Filled Water capacity Container load	Pool Part:4150mmx2200mmx1300mm 5950mmx2300mmx1400mm 850KG/10250KG 2482 US Gallon/ 9400Liters 1pc/ 20GP; 2pc/ 40ft
Shell Shell colors Shell material	10 color available Aristech Acrylic
Pumps--SPA Part (UL, CE, KC approved) Jet pump 1: 2.0HP Jet pump 2: 2.0HP Circulation pump:400W Air blower:1.0HP	Pumps--Pool Part (UL, CE, KC approved) Swim pump: 3.0HP x 3pcs Jet pump: 2.0HP x 1pc Circulation pump:1HP Air blower: 1.5HP
Electrics--SPA Part Control system: America Balboa control Max power consumption: 7500Watt 11.4A in 380V 50Hz Heater: 3KW/220-240VAC Underwater lighting:5 LED	Electrics--Swimming Part Control system: America Balboa control Max power consumption: 13125Watt 19.9A in 380V 50Hz Heater: 3KW/220-240VAC Underwater lighting:5 LED
Jet --SPA Part Jets total (pc):74 Massage jets (pc): 65 Swim jet (pc): 0 Air jets (pc): 9	Jet --Swimming Part Jets total (pc):60 Massage jets (pc): 41 Swim jet (pc): 9 Air jets (pc): 10
Filtration Filter Effective Filtration Area Ozone Generator	Front access filters x 2pcs 100 sq. ft. 50mg/h
Features Water diverter(pc): 2 Air regulator(pc): 3 Suctions (pc): 4 Drain valve (pc): 1 Headrest pillows(pc):2 Support frame Overflow outlet (pc): Skirt:	Water diverter(pc): 2 Air regulator(pc): 3 Suctions (pc): 6 Drain valve (pc): 1 Headrest pillows(pc): 2 #304 Stainless steel 2 Brown/ Grey / Black color

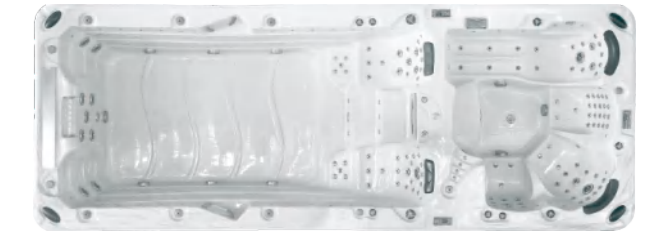

*Relaxation,
Entertainment,
Therapy, **Exercise...***



SR-856 SPECIFICATION

Size: 11750X2200X1600MM

SPA part	Swimming part
Seating Capacity: 5 Persons	Seating Capacity: 0
Lounge: 1 Persons	Persons Lounge: N/A
Dimensions/Weight/ Container load	
Product dimension	11750mmx2200mmx1600mm
Packing dimension	11850mmx2300mmx1700mm
Weight - Dry/Filled	1900KG/ 26900KG
Water capacity	6605 US Gallon/ 25000Liters
Container load	0pc/ 20GP; 1pc/ 40ft
Shell	
Shell colors	5 color available
Shell material	Aristech Acrylic
Pumps--SPA Part (UL, CE, KC approved)	Pumps--Swimming Part (UL, CE, KC approved)
Jet pump 1: 2.0HP	Swim pump: 3.0HP x 5pcs
Jet pump 2: 2.0HP	Jet pump: N/A
Circulation pump: 1HP	Circulation pump: 1HP
Air blower: N/A	Air blower: N/A
Electrics--SPA Part	Electrics--Swimming Part
Control system	Control system
America Balboa control	America Balboa control
Max power consumption:	Max power consumption:
6790Watt 10.3A in 380V 50Hz	15000Watt 22.8A in 380V 50Hz
Heater: 3KW/220-240VAC	Heater: 3KW/220-240VACU
Underwater lighting: 5 LEDx1pc	Underwater lighting: 5 LEDx2pcs
Jet --SPA Part	Jet --Swimming Part
Jets total (pc): 38	Jets total (pc): 6
Massage jets (pc): 38	7.5" direct direct injection
	Swim jet (pc): 6
Filtration	
Filter	Double Top-mount filters
Sand filter for swimming end	1set
Ozone Generator	100mg/h
Features	
Water diverter(pc): 1	Water diverter(pc): 2
Air regulator(pc): 1	Air regulator(pc): 1
Suctions (pc): 3	Suctions (pc): 5
Drain valve (pc): 1	Drain valve (pc): 1
Headrest pillows(pc): 3	Headrest pillows(pc): 0
Support frame	#304 Stainless steel
Overflow outlet (pc):	2
Skirt:	Brown/ Grey / Black color

There's no place like home for rest and relaxation

That's why we've designed a number of spa shapes and sizes to fit beautifully in the setting of your home. Style and comfort truly come together in a Sunrans Spa.

Taste care in warm water. You can enjoy most wonderful and memorable experience in the world. Water flows over your body and fatigue can be removed completely.

Water can release working pressure and lets you be lost in most beautiful daydream.

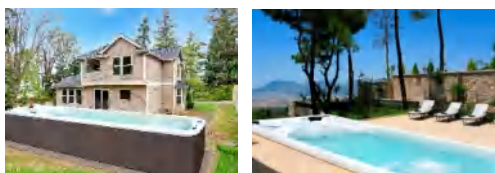



SR-8806A SPECIFICATION

Size: 5500x2250x1500MM

Seating	
Seating Capacity	3 Persons
Lounge	0 persons
Dimensions/Weight/ Container load	
Product dimension	5500mmx2250mmx1500mm
Packing dimension	5600mmx2350mmx1650mm
Weight - Dry/Filled	1100KG/ 7600KG
Water capacity	1720 US Gallon/ 6500Liters
Container load	1pcs/20ft; 2pcs/40ft
Shell	
Shell colors	6color available
Shell material	Aristech Acrylic
Pumps (UL,CE, KC approved)	
Propeller Swim pump	6.67HP
Jet pump 1	2.0HP
Jet pump 2	2.0HP
Circulation pump	1.0HP
Electrics	
Control system	America Balboa control
Max power consumption:	11750Watt 17A in 380V 50Hz
Heater (America Balboa brand)	3KW/220-240VAC
Underwater lighting	5*LED

Jet Configurations	
Jets total (pc)	35pcs
High efficiency propeller for swimming (pc)	1
5" Massage jets (pc)	6 (Direct-jet)
3.5" Massage jets (pc)	17 (Direct-jet)
2" Massage jets (pc)	11
Filtration	
High-efficiency Filter	Top mount filters
Effective Filtration Area	200 sq. ft.
Ozone Generator	200mg/h
Features	
Fountain with LED (pc)	Option
Water diverter(pc)	1
Air regulator(pc)	1
Suctions (pc)	10
Gate valves (pc)	2
Drain valve (pc)	1
Headrest pillows(pc)	2
Support frame	#304 Stainless steel
Overflow outlet (pc)	1
Skirt:	H03, H06, H19, H21A
Handrail (pc)	0
ABS base	1





SR-8822 Dual Temps Models

General info	Seating Capacity	3 seats and 1 lounge in Spa zone		
	Massage Jets (pcs)	47		
	River jets for swimming (pcs)	3		
	Skirt / Color	Woodplastic Sheet / H03,H06,H19,H21A		
	Brand of Acrylic	Aristech		
	Sealed base	v		
	Interior Stainless steel Frame	v		
	Specifications			
		Standard		Turbine
		Spa side	Swim side	Spa side
		Balboa	Balboa	Balboa
Spa Control System/ Heater		BP6013G2	BP6013G3	BP6013G2
		3Kw heater	3Kw heater	3Kw heater
Control panel		TP600A	TP600B	TP600A
		TP600A	TP600B	TP500
Jet Pump/quantity /Model		2HP *2pcs (LP200)	3HP *3pcs (LP300)	2HP *2pcs (LP200)
Electrics configuration		0 5HP (JA50)	1HP (EA350)	0 5HP (JA50)
				1HP (EA350)
(To customized specifications, please check option list)	Swim turbine			1set (5Kw) with Topside control
	Waterline LED lights (pc)	option	option	option
	Bottom LED light (pc)	v	v	v
	Ozone sanitizer 200mg/h	v	v	v
	UV lamp 15watt	option	option	option
	Wifi Ready (Bwa)	option	option	option
	Bluetooth Audio 4.0	option	option	option
	Speaker (topside type)	option	option	option
Jet Configuration	River jets for swimming (pcs)	X	3	X
	7.5inches water jets (pcs)	1	X	X
	9.5inches water jets (pcs)	9	X	X
	3.5inches water jets (pc)	16	X	X
	2inches water jets	21	X	X
Equipments	Nordic Cover	v		v
	Entry steps	option		option
	Swim Tether	option		option
	Shell insulation	option		option
	Pipes insulation	option		option
	Skirt insulation	option		option
	Heat reflecting foil (inside)	option		option
Other fittings	Filters (pcs)	2	4	2
	EVA Headrest pillow	2	X	X
	Cup Holder (pcs)	2	X	X
	Waterfall (pcs)	1	X	X



SR8822A 5800x2280x1500mm



SR8822B 6800x2280x1500mm



SR8822C 7800x2280x1500mm



SR8822D 8800x2280x1500mm



SR8822E 9800x2280x1500mm



SR8822F 10800x2280x1500mm



SR8822G 11800x2280x1500mm

INTERNATIONAL
CERTIFICATION
ISO 9001



RoHS
Compliant





SR8824A 3800x2280x1500mm



SR8824B 4800x2280x1500mm



SR8824C 5800x2280x1500mm



SR8824D 6800x2280x1500mm



SR8824E 7800x2280x1500mm



SR8824F 8800x2280x1500mm



SR8824G 9800x2280x1500mm



SR-8824 Absolute Models

General info	Seating Capacity	3 seats	
	Massage Jets (pcs)	22	
General info	River jets for swimming (pcs)	3	
	Skirt / Color	Woodplastic Sheet / H03,H06,H19,H21A	
	Brand of Acrylic	Aristech	
	Sealed base	v	
	Interior Stainless steel Frame	v	
Specifications			
		Standard	Turbine
Spa Control /Heater		Balboa BP21P4BC / 3Kw heater	Balboa BP21P4BC / 3Kw heater
Control panel		Balboa TP700	Balboa TP700
Electrics configuration	Jet Pump/quantity /Model	3HP *4pcs (LP300)	3HP *1pc (LP300)
	Circulating pump	1Hp (EA350)	1Hp (EA350)
	Swim Turbine		1set (5Kw) with Topside control
(To customized specifications, please check option list)	Waterline LED lights (pc)	option	option
	Bottom LED light (pc)	v	v
	Ozone sanitizer 200mg/h	v	v
	UV lamp 15watt	option	option
	Wifi Ready (Bwa)	option	option
	Bluetooth Audio 4.0	option	option
	Speaker (topside type)	option	option
Jet Configuration	River jets (pc)	3	9pcs
	5inches water jets (pc)	9pcs	9pcs
	3.5inches water jets (pc)	8pcs	8pcs
	2inches water jets (pc)	5pcs	5pcs
Equipments	Nordic Cover	v	v
	Entry steps	option	option
	Swim Tether	option	option
	Shell insulation	v	v
	Pipes insulation	v	v
	Skirt Insulation	v	v
	Heat reflecting foil (inside)	v	v
Other fittings	Filters (pcs)	4	4
	EVA Headrest pillow	2	2
	Cup Holder (pcs)	2	2
	Waterfall (pcs)	2	2





SR-821 SPECIFICATION

Size: 3850X2200X1200MM

Seating	
Seating Capacity	5 Persons
Lounge	1 persons

Dimensions/Weight/ Container load	
Product dimension	3850mmx2200mmx1200mm
Packing dimension	3950mmx2300mmx1300mm
Weight - Dry/Filled	800KG/6850KG
Water capacity	1597US Gallon/ 6050Liters
Container load	1pc/20ft ; 6pcs/40HQ

Shell	
Shell colors	10 color available
Shell material	Aristech Acrylic

Pumps (UL,CE, KC approved)	
Jet pump 1	3.0HP
Jet pump 2	3.0HP
Jet pump 3	3.0HP
Jet pump 4	2.0HP
Jet pump 5	2.0HP
Circulation pump	1.0HP
Air blower	1.5HP

Electrics	
Control system	America Balboa control
Max power consumption:	13715 Watt 20.8A in 380V 50Hz
Heater (America Balboa brand)	3KW/220-240VAC
Underwater lighting	5 LED

Jet Configurations	
Jets total (pc)	59
Swim jets (pc)	5
Massage jets (pc)	46
Air jets (pc)	8

Filtration	
Filter	Front access filters
Effective Filtration Area	100 sq. ft.
Ozone Generator	50mg/h

Features	
Water diverter(pc)	4
Air regulator(pc)	4
Suctions (pc)	6
Gate valves (pc)	12
Drain valve (pc)	1
Headrest pillows(pc)	2
Support frame	#304 Stainless steel
Overflow outlet (pc)	1
Skirt:	Brown/ Grey / Black color



SR-853 SPECIFICATION

Size: 4300x2200x1350MM

Seating	
Seating Capacity	1 Persons
Lounge	2 Persons

Dimensions/Weight/ Container load	
Product dimension	4300x2200x1360mm
Packing dimension	4400x2300x1460mm
Weight - Dry/Filled	690KG/ 6190KG
Water capacity	1453 US Gallon/ 5500Liters
Container load	1pc/ 20ft ; 2pcs/ 40ft

Shell	
Shell colors	10 color available
Shell material	Aristech Acrylic

Pumps (UL,CE, KC approved)	
Swim pump	3.0HPx3pcs
Jet pump	2.0HPx1pc
Circulation pump	1.0HP

Electrics	
Control system	America Balboa control
Max power consumption:	12000Watt 18.2A in 380V 50Hz
Heater (America Balboa brand)	3KW/220-240VAC
Underwater lighting	5 LED

Jet Configurations	
Jets total (pc)	36
7.5" direct direct injection Swim jet (pc)	6
Massage jets 3.5"(pc)	8
Massage jets 1.5"(pc)	22

Filtration	
High-efficiency Filter (3 filters)	Top mount filters
Effective Filtration Area	150 sq. ft.
Ozone Generator	50mg/h

Features	
Fountain with LED (pc)	4
Water diverter(pc)	1
Air regulator(pc)	2
Suctions (pc)	6
Gate valves (pc)	2
Drain valve (pc)	1
EVA Headrest pillows(pc)	2
Support frame	#304 Stainless steel
Overflow outlet (pc)	1
Skirt:	Brown/ Grey / Black color



SR-8804B SPECIFICATION

Size: 3700x2250x1500MM
3700x2250x1200MM

Seating	
Seating Capacity	5 Persons
Lounge	0 Persons

Dimensions/Weight/ Container load	
Product dimension	3700x2250x1500mm/1200mm
Packing dimension	3800x2300x1650mm/1350mm
Weight - Dry/Filled	610KG/ 6110KG
Water capacity	1455 US Gallon/ 5500Liters
Container load	1pc/ 20ft 3pcs/ 6pcs/ 40ft

Shell	
Shell colors	6 color available
Shell material	Aristech Acrylic

Pumps (UL,CE, KC approved)	
Swim pump	3.0HPx3pcs
Jet pump	3.0HPx1pc
Circulation pump	1.0HP

Electrics	
Control system	America Balboa control
Max power consumption:	12750Watt 18.5A in 380V 50Hz
Heater (America Balboa brand)	3KW/220-240VAC
Underwater lighting	5 LED

Jet Configurations	
Jets total (pc)	35pcs
Super size U shape swim jets (pc)	3
5" Massage jets (pc)	4 (Direct-jet)
3.5" Massage jets (pc)	17 (Direct-jet)
2" Massage jets (pc)	11

Filtration	
High-efficiency Filter	Top mount filters
Effective Filtration Area	200 sq. ft.
Ozone Generator	200mg/h

Others	
Fountain with LED (pc)	Option
Water diverter(pc)	1
Air regulator(pc)	1
Suctions (pc)	8
Gate valves (pc)	2
Drain valve (pc)	1
Headrest pillows(pc)	2
Overflow outlet (pc)	1
Skirt:	H03,H06 ,H19, H21A
Handrail (pc)	0
ABS base	1





SR-8802B

SPECIFICATION
Size: 5900x2250x1500MM

SPA part	Swimming part
Seating Capacity: 4 Persons	Seating Capacity: 0 Persons
Lounge: 1 Person	Lounge: 0 Persons
Dimensions/Weight/ Container load	
Product dimension	5900mm x 2250mm x 1500mm
Packing dimension	6000mm x 2350mm x 1650mm
Weight - Dry/Filled	1250KG/ 11450KG
Water capacity	2693 US Gallon/ 10200Liters
Container load	0pc/ 20GP; 2pc/ 40ft
Shell	
Shell colors	6 color available
Shell material	Aristech Acrylic
Pumps--SPA Part	
(UL, CE, KC approved)	Pumps--Swimming part
Jet pump 1: 2.0HP	(UL, CE, KC approved)
Jet pump 2: 2.0HP	Swim pump: 3.0HP x 3pcs
Circulation pump: 400W	Jet pump: N/A
Air blower: Option	Circulation pump: 1HP
	Air blower: Option
Electrics(SPA part)	
Control system: Balboa control	Electrics(Swimming part)
Max power consumption:	Control system: Balboa control
6450Watt 9.8A in 380V 50Hz	Max power consumption:
Heater: 3KW/220-240VAC	12050Watt 18.3A in 380V 50Hz
Underwater lighting: 5" LED	Heater: 3KW/220-240VAC
	Underwater lighting: 5" LED
Jet --SPA Part	
Jets total (pc): 44	Jet --Swimming Part
Swim jet (pc): N/A	Jets total (pc): 3
7.5" Massage jets (pc): 1	Super size U shape swim jets (pc): 3
5" Massage jets (pc): 13	Massage jets (pc): N/A
3.5" Massage jets (pc): 14	
2" Massage jets (pc): 16	
Air jets (pc): Option	Air jets (pc): Option
Filtration	
High-efficiency Filter	Top mount filters (4 filters)
Effective Filtration Area	200 sq. ft.
Ozone Generator	200mg/h
Others--SPA Part	
Water diverter (pc): 1	Others--Swimming Part
Air regulator (pc): 3	Water diverter (pc): 0
Suctions (pc): 7	Air regulator (pc): 0
Drain valve (pc): 1	Suctions (pc): 5
Headrest pillows (pc): 2	Drain valve (pc): 1
Support frame	Headrest pillows (pc): 0
Overflow outlet (pc): 2	#304 Stainless steel
Skirt:	2
Handrail (pc)	#304 Stainless steel
ABS base	1
Cup holder with LED (pc)	2



SR-855

SPECIFICATION
Size: 6700X2200X1650MM

Seating	
Seating Capacity	2 Persons
Lounge	N/A
Dimensions/Weight/ Container load	
Product dimension	6700mm x 2200mm x 1530mm
Packing dimension	6800mm x 2300mm x 1630mm
Weight - Dry/Filled	1050KG/ 16050KG
Water capacity	3963 US Gallon/ 15000Liters
Container load	0pc/20ft; 1pc/ 40ft
Shell	
Shell colors	5 color available
Shell material	Aristech Acrylic
Pumps (UL, CE, KC approved)	
Swimming pump	3.0HP x 3pcs
Jet pump	2.0HP x 1pc
Fountain pump with separate electronic control	0.53HP x 1pc
Circulation pump	1HP x 1pc
Electrics	
Control system	America Balboa control
Max power consumption:	12400W 18.8A in 380V/50Hz
Heater (America Balboa brand)	3KW/220-240VAC
Underwater lighting	5" LED x 2pcs
Jet Configurations	
Jets total (pc)	44
U-Swim jets (pc)	3
Super size jets 5" (pc)	1
Massage jets 3.5" (pc)	2
Massage jets 1" (pc)	38
Filtration	
Filter	Double Top-mount filters
Effective Filtration Area	100 sq. ft.
Ozone Generator	50mg/h
Features	
Fountains (pc)	12
Water diverter 2" (pc)	1
Air regulator (pc)	1
Suctions (pc)	6
Gate valves (pc)	2
Drain valve (pc)	1
Headrest pillows (pc)	2
Support frame	#304 Stainless steel
Overflow outlet (pc)	1
Skirt:	Brown/ Grey / Black color



SR-860

SPECIFICATION
Size: 5700X2200X1300MM

Seating	
Seating Capacity	2 Persons
Lounge	2 Persons
Dimensions/Weight/ Container load	
Product dimension	5700 x 2200 x 1300mm
Packing dimension	5800mm x 2300mm x 1400mm
Weight - Dry/Filled	805KG/9308KG
Water capacity	2244 US Gallon/8500Liters
Container load	1pcs/20ft ; 2pcs/40ft
Shell	
Shell colors	10 color available
Shell material	Aristech Acrylic
Pumps (UL, CE, KC approved)	
Swim pump 1	3.0HP
Swim pump 2	3.0HP
Swim pump 3	3.0HP
Jet pump 1	2.0HP
Jet pump 2	2.0HP
Circulation pump	1HP
Air blower	N/A
Electrics	
Control system	America Balboa control
Max power consumption:	14725Watt 22.4A in 380V 50Hz
Heater (America Balboa brand)	3KW/220-240VAC
Underwater lighting	5" LED x 2pcs
Jet Configurations	
Jets total (pc)	67
Super size swim jets (pc)	4
Massage jets (pc)	63
Air jets (pc)	N/A
Filtration	
Filter	Top mount filters x 2pcs
Effective Filtration Area	100 sq. ft.
Ozone Generator	50mg/h
Features	
Water diverter with LED (pc)	2
Air regulator (pc)	2
Suctions (pc)	8
Gate valves (pc)	12
Drain valve (pc)	1
Headrest pillows (pc)	4
Support frame	#304 Stainless steel
Overflow outlet (pc)	1
Umbrella waterfall with LED	1
Skirt:	Brown/ Grey / Black color



SR-8805B

SPECIFICATION
Size: 4500X2250X1500MM

Seating	
Seating Capacity	4 Persons
Lounge	1 Persons
Dimensions/Weight/ Container load	
Product dimension	4500 x 2250 x 1500mm
Packing dimension	4600mm x 2350mm x 1600mm
Weight - Dry/Filled	810KG/7310KG
Water capacity	1717 US Gallon/6500Liters
Container load	1pcs/20ft ; 2pcs/40ft
Shell	
Shell colors	6 color available
Shell material	Aristech Acrylic
Pumps (UL, CE, KC approved)	
Swim pump 1	3.0HP
Swim pump 2	3.0HP
Swim pump 3	3.0HP
Jet pump 1	3.0HP
Jet pump 2	N/A
Circulation pump	1.0HP
Air blower	N/A
Electrics	
Control system	America Balboa control
Max power consumption:	12750Watt 18.5A in 380V 50Hz
Heater (America Balboa brand)	3KW/220-240VAC
Underwater lighting	5" LED
Jet Configurations	
Jets total (pc)	40
Super size U shape swim jets (pc)	3
Massage jets (pc)	37
Air jets (pc)	N/A
Filtration	
High-efficiency Filter	Top mount filters
Effective Filtration Area	200 sq. ft.
Ozone Generator	200mg/h
Features	
Water diverter with LED (pc)	1
Air regulator (pc)	1
Suctions (pc)	9
Gate valves (pc)	2
Drain valve (pc)	1
Headrest pillows (pc)	2
Support frame	#304 Stainless steel
Overflow outlet (pc)	1
Skirt:	H03, H06, H19, H21A
Handrail (pc)	0
ABS base	1

Innovative R & D quality as one
Athena series New





SR-805A SPECIFICATION

Size: 2230X2230X940MM

Seating	
Seating Capacity	3 Persons
Lounge	2 persons

Dimensions/Weight/ Container load	
Product dimension	2230mmx2230mmx940mm
Packing dimension	2330mmx2330mmX1040mm
Weight - Dry/Filled	395KG/1645KG
Water capacity	330US Gallon/1250Liters
Container load	5pcs/20ft; 10pcs/40ft

Shell	
Shell colors	10 color available
Shell material	Aristech Acrylic

Pumps (UL, CE, KC approved)	
Jet pump 1	2.0HP
Jet pump 2	2.0HP
Circulation pump	400w
Air blower	N/A

Electrics	
Control system	US Balboa system
Power supply	220V/50HZ
Heater (America Balboa brand)	3KW/220-240VAC
Underwater lighting	5 LED
Skirt corner LED light	12pcs
Logo LED light	3pcs

Jet Configurations	
Jets total (pc)	61
5.0 inches Massage jets (pc)	2
3.5inches Massage jets (pc)	21(14pcs D-jet, 7pcs Rotating jet)
2.5inches Massage jets (pc)	4
1.0inches Massage jets (pc)	34
Air jets (pc)	N/A

Filtration	
Top mount filter	3pcs
Effective Filtration Area	100 sq. ft.
Ozone Generator	50mg/h

Features	
Water diverter(pc)	2
Air regulator(pc)	4
Stainless steel fountain	3
2inches Suctions (pc)	4
Drain valve (pc)	1
EVA Headrest pillows(pc)	3
Support frame	#304 thickening Stainless steel
Overflow outlet (pc)	N/A
PVC Skirt	Natural/brown/grey available
ABS base:	1

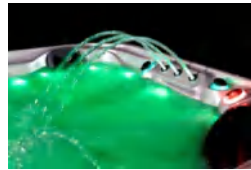

SR-812A SPECIFICATION

Size: 2300X2200X940MM

Seating	
Seating Capacity	3 Persons
Lounge	2 persons

Dimensions/Weight/ Container load	
Product dimension	2300mmx2200mmx940mm
Packing dimension	2400mmx2300mmx1040mm
Weight - Dry/Filled	410KG/ KG/ 1760KG
Water capacity	357 US Gallon/ 1350Liters
Container load	5pcs/20ft; 12pcs - 15pcs/40ft

Shell	
Shell colors	10 color available
Shell material	Aristech Acrylic

Pumps (UL, CE, KC approved)	
Jet pump (two-speed)	1*3.0HP
Air blower	N/A

Electrics	
Control system	America Balboa control
Max power consumption:	5350Watt 24.3A in 220V 50Hz
Heater (America Balboa brand)	3KW/220-240VAC
Underwater lighting	5 LED
Skirt corner LED light	12pcs
Logo LED light	3pcs

Jet Configurations	
Jets total (pc)	29
5.0 inches Massage jets (pc)	1 (rotating jet)
3.5inches Massage jets (pc)	6 (3pcs d-jets, 3pcs R-jets)
1.0inches Massage jets (pc)	22 (direct-jets)
Air jets (pc)	N/A

Filtration	
Filter	Front access filters
Effective Filtration Area	100 sq. ft.
Ozone Generator	50mg/h

Features	
Water diverter(pc)	1
Air regulator(pc)	2
Suctions (pc)	2
Gate valves (pc)	2
Drain valve (pc)	1
Headrest pillows(pc)	3
Support frame	#304 Stainless steel
Overflow outlet (pc)	1
Skirt(Exclusive for New Eco Series)	Brown/Grey /Coffee color.
Black ABS corner(Exclusive)	1
ABS base:	1

SR-806A SPECIFICATION

Size: 2230X2230X940MM

Seating	
Seating Capacity	5 Persons
Lounge	1 persons

Dimensions/Weight/ Container load	
Product dimension	2230mmx2230mmx940mm
Packing dimension	2330mmx2330mmX1040mm
Weight - Dry/Filled	395KG/1645KG
Water capacity	330US Gallon/1250Liters
Container load	5pcs/20ft, 10pcs/40ft

Shell	
Shell colors	10 color available
Shell material	US Aristech Acrylic

Pumps (UL,CE, KC approved)	
Jet pump 1	2.0HP
Jet pump 2	2.0HP
Circulation pump	400w
Air blower	N/A

Electrics	
Control system	US Balboa system
Power supply	220V/50HZ
Heater (America Balboa brand)	3KW/220-240VAC
Underwater lighting	5 LED
Skirt corner LED light	12pcs
Logo LED light	3pcs

Jet Configurations	
Jets total (pc)	49
5.0 inches Massage jets (pc)	4
3.5inches Massage jets (pc)	22(10pcs D-jet, 12pcs Rotating)
2.5inches Massage jets (pc)	2
1.0inches Massage jets (pc)	21
Air jets (pc)	N/A

Filtration	
Top mount filter	3pcs
Effective Filtration Area	100 sq. ft.
Ozone Generator	50mg/h

Features	
Water diverter(pc)	1
Air regulator(pc)	4
Stainless steel fountain	3
2inches Suctions (pc)	3
Drain valve (pc)	1
EVA Headrest pillows(pc)	3
Support frame	#304 thickening Stainless steel
Overflow outlet (pc)	N/A
PVC Skirt:	Natural/brown/grey available
ABS base:	1



*Creat the high
quality products which
fulfill the concept of fashion*



SR-801A SPECIFICATION

Size: 2230X2230X940MM

Seating		Jet Configurations	
Seating Capacity	5 Persons	Jets total (pc)	28
Lounge	1 persons	3.5inches massage jets (pc)	6 (3pcs d-jets, 3pcs R-jets)
		1.0inches massage jets (pc)	22 (direct jets)
		Air jets (pc)	N/A

Dimensions/Weight/ Container load		Filtration	
Product dimension	2230mmx2230mmx940mm	Filter	Front access filters
Packing dimension	2330mmx2330mmx1040mm	Effective Filtration Area	100 sq. ft.
Weight - Dry/Filled	350KG/ 1600KG	Ozone Generator	50mg/h
Water capacity	330US Gallon/ 1250Liters		
Container load	5pcs/20ft; 12pcs/40ft		

Shell		Features	
Shell colors	10 color available	Water diverter(pc)	2
Shell material	Aristech Acrylic	Air regulator(pc)	2
		Suctions (pc)	2
		Gate valves (pc)	2
		Drain valve (pc)	1
		Headrest pillows(pc)	3
		Support frame	#304 Stainless steel
		Overflow outlet (pc)	N/A/Brown/Grey /Coffee color
		Skirt(Exclusive for New Eco Series)	1
		Black ABS corner(Exclusive)	1
		ABS base:	1

Pumps (UL,CE, KC approved)		Electrics	
Jet pump (two-speed)	1*3.0HP	Control system	America Balboa control
Air blower	N/A	Max power consumption:	5350Watt 24.3A in 220V 50Hz
		Heater (America Balboa brand)	3KW/220-240VAC
		Underwater lighting	5 LED
		Skirt corner LED light	12pcs
		Logo LED light	3pcs



SR-801B SPECIFICATION

Size: 2230X2230X800MM

Seating		Jet Configurations	
Seating Capacity	5 Persons	Jets total (pc)	28
Lounge	1 persons	3.5inches massage jets (pc)	6 (3pcs d-jets,3pcs R-jets)
Dimensions/Weight/ Container load		1.0inches massage jets (pc)	22 (direct jets)
Product dimension	2230mmx2230mmx800mm	Air jets (pc)	N/A
Packing dimension	2330mmx2330mmx900mm	Filtration	
Weight - Dry/Filled	350KG/ 1600KG	Filter	Front access filters
Water capacity	330US.Gallon/ 1250Liters	Effective Filtration Area	100 sq. ft.
Container load	5pcs/20ft. 15pcs/40ft	Ozone Generator	50mg/h
Shell		Features	
Shell colors	10 color available	Water diverter(pc)	2
Shell material	Aristech Acrylic	Air regulator(pc)	2
Pumps (UL,CE, KC approved)		Suctions (pc)	2
Jet pump (two-speed)	1*3.0HP	Gate valves (pc)	2
Air blower	N/A	Drain valve (pc)	1
Electrics		Headrest pillows(pc)	3
Control system	America Balboa control	Support frame	#304 Stainless steel
Max power consumption:	5350Watt 24.3A in 220V 50Hz	Overflow outlet (pc)	N/A
Heater (America Balboa brand)	3KW/220-240VAC	Skirt(Exclusive for New Eco Series)	Brown/Grey /Coffee color
Underwater lighting	5 LED	ABS base:	N/A
Logo LED light	3pcs		

SR-812B SPECIFICATION

Size: 2300X2200X800MM

Seating	
Seating Capacity	3 Persons
Lounge	2 persons
Dimensions/Weight/ Container load	
Product dimension	2300mmx2200mmx800mm
Packing dimension	2400mmx2300mmx900mm
Weight - Dry/Filled	410KG/ KG/ 1760KG
Water capacity	357 US.Gallon/ 1350Liters
Container load	5pcs/20ft. 15pcs/40ft
Shell	
Shell colors	10 color available
Shell material	Aristech Acrylic
Pumps (UL,CE, KC approved)	
Jet pump (two-speed)	1*3.0HP
Air blower	N/A
Electrics	
Control system	America Balboa control
Max power consumption:	5350Watt 24.3A in 220V 50Hz
Heater (America Balboa brand)	3KW/220-240VAC
Underwater lighting	5 LED
Logo LED light	3pcs
Jet Configurations	
Jets total (pc)	29
5.0inches massage jets (pc)	1 (rotating jet)
3.5inches massage jets (pc)	6 (3pcs d-jets,3pcs R-jets)
1.0inches massage jets (pc)	22 (direct jets)
Air jets (pc)	N/A
Filtration	
Filter	Front access filters
Effective Filtration Area	100 sq. ft.
Ozone Generator	50mg/h
Features	
Water diverter(pc)	1
Air regulator(pc)	2
Suctions (pc)	2
Gate valves (pc)	2
Drain valve (pc)	1
Headrest pillows(pc)	3
Support frame	#304 Stainless steel
Overflow outlet (pc)	1
Skirt(Exclusive for New Eco Series)	Brown/Grey /Coffee color



*Swimming for 20 minutes,
Equivalent to running half an hour.*

SR-832A SPECIFICATION

Size: 2790X2200X940MM

Seating	
Seating Capacity	7 Persons
Lounge	1 persons

Dimensions/Weight/ Container load	
Product dimension	2790mmx2200mmx940mm
Packing dimension	2890mmx2300mmx1040mm
Weight - Dry/Filled	480KG/2430KG
Water capacity	515 US Gallon/1950Liters
Container load	4pcs/20ft; 8pcs/40ft

Shell	
Shell colors	10 color available
Shell material	USA Aristech Acrylic

Pumps (UL,CE, KC approved)	
Jet pump 1	2.0HP
Jet pump 2	2.0HP
Jet pump 3	2.0HP
Circulation pump	0.53HP
Air blower	N/A

Electrics	
Control system	America Balboa control
Max power consumption:	7950Watt 34.6A in 220V 50Hz
Heater (America Balboa brand)	3KW
Underwater lighting	5 LED
Skirt corner LED light	12pcs
Logo LED light	3pcs

Jet Configurations	
Jets total (pc)	112
5.0 inches Massage jets (pc)	5(2pcs D-jet,3pcs Rotating jet)
3.5inches Massage jets (pc)	9(5pcs D-jet,4pcs Rotating jet)
2.5inches Massage jets (pc)	2
1.0inches Massage jets (pc)	96
Air jets (pc)	N/A

Filtration	
Top mount filter	3pcs
Effective Filtration Area	100 sq. ft.
Ozone Generator	200mg/h

Features	
Water diverter with LED (pc)	2
Air regulator with LED(pc)	4
Stainless steel fountain with LED	2
2inches Suctions (pc)	5
Drain valve (pc)	1
EVA Headrest pillows(pc)	3
Support frame	#304 thickening Stainless steel
Overflow outlet (pc)	N/A
Skirt(New wide board):	Natural/brown/grey available
ABS base:	1

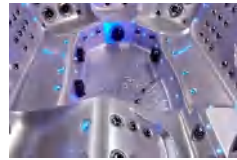

SR-832B SPECIFICATION

Size: 2600X2200X940MM

Seating		Jet Configurations	
Seating Capacity	7 Persons	Jets total (pc)	84
Lounge	1 persons	5.0 inches Massage jets (pc)	4(2pcs D-jet,2pcs Rotating jet)
		3.5inches Massage jets (pc)	18(9pcs D-jet,9pcs Rotating jet)

Dimensions/Weight/ Container load		Filtration	
Product dimension	2600mmx2200mmx940mm	Top mount filter	3pcs
Packing dimension	2700mmx2300mmx1040mm	Effective Filtration Area	100 sq. ft.
Weight - Dry/Filled	450KG/2100KG	Ozone Generator	200mg/h
Water capacity	422 US Gallon/1600Liters		
Container load	4pcs/20ft; 8pcs/40ft		

Shell		Features	
Shell colors	10 color available	Water diverter with LED (pc)	2
Shell material	USA Aristech Acrylic	Air regulator with LED(pc)	2
		Stainless steel fountain with LED	2

Pumps (UL,CE, KC approved)		Filtration	
Jet pump 1	2.0HP	Top mount filter	3pcs
Jet pump 2	2.0HP	Effective Filtration Area	100 sq. ft.
Jet pump 3	2.0HP	Ozone Generator	200mg/h
Circulation pump	0.53HP		
Air blower	N/A		

Electrics		Features	
Control system	America Balboa control	Water diverter with LED (pc)	2
Max power consumption:	7950Watt 34.6A in 230V 50Hz	Air regulator with LED(pc)	2
Heater (America Balboa brand)	3KW	Stainless steel fountain with LED	2
Underwater lighting	5 LED	Cup holder with LED	2
Skirt corner LED light	12pcs	2inches Suctions (pc)	4
Logo LED light	3pcs	Drain valve (pc)	1
		EVA Headrest pillows(pc)	3

Dimensions/Weight/ Container load		Filtration	
Product dimension	2600mmx2200mmx940mm	Top mount filter	3pcs
Packing dimension	2700mmx2300mmx1040mm	Effective Filtration Area	100 sq. ft.
Weight - Dry/Filled	450KG/2100KG	Ozone Generator	200mg/h
Water capacity	422 US Gallon/1600Liters		
Container load	4pcs/20ft; 8pcs/40ft		

Shell		Features	
Shell colors	10 color available	Water diverter with LED (pc)	2
Shell material	USA Aristech Acrylic	Air regulator with LED(pc)	2
		Stainless steel fountain with LED	2

Pumps (UL,CE, KC approved)		Filtration	
Jet pump 1	2.0HP	Top mount filter	3pcs
Jet pump 2	2.0HP	Effective Filtration Area	100 sq. ft.
Jet pump 3	2.0HP	Ozone Generator	200mg/h
Circulation pump	0.53HP		
Air blower	N/A		

Electrics		Features	
Control system	America Balboa control	Water diverter with LED (pc)	2
Max power consumption:	7950Watt 34.6A in 230V 50Hz	Air regulator with LED(pc)	2
Heater (America Balboa brand)	3KW	Stainless steel fountain with LED	2
Underwater lighting	5 LED	Cup holder with LED	2
Skirt corner LED light	12pcs	2inches Suctions (pc)	4
Logo LED light	3pcs	Drain valve (pc)	1
		EVA Headrest pillows(pc)	3



SR-808A SPECIFICATION

Size: 2130X1650X875MM

Seating		Jet Configurations	
Seating Capacity	1 Persons	Jets total (pc)	43
Lounge	2 persons	3.5inches Massage jets (pc)	4(2pcs D-jet,2pcs Rotating jet)
Dimensions/Weight/ Container load		1.0inches Massage jets (pc)	39
Product dimension	2130mmx1650mmx875mm	Air jets (pc)	N/A
Packing dimension	2230mmx1750mmX975mm	Filtration	
Weight - Dry/Filled	295KG/ 1090KG	Top mount filter	1pcs
Water capacity	210US gallon/795L	Effective Filtration Area	100 sq. ft.
Container load	6pcs/20ft., 13pcs/40ft	Ozone Generator	50mg/h
Shell		Features	
Shell colors	10 color available	Water diverter(pc)	2
Shell material	US Aristech Acrylic	Air regulator(pc)	2
Pumps (UL,CE, KC approved)		Stainless steel fountain	3
Jet pump 1	2.0HP	2inches Suctions (pc)	4
Jet pump 2	2.0HP	Drain valve (pc)	1
Circulation pump	400w	EVA Headrest pillows(pc)	2
Air blower	N/A	Support frame	#304 thickening Stainless steel
Electrics		Overflow outlet (pc)	N/A
Control system	US Balboa system	PVC Skirt:	Natural/brown/grey available
Power supply	220V/50HZ	ABS base:	1
Heater (America Balboa brand)	3KW/220-240VAC		
Underwater lighting	5 LED		
Skirt corner LED light	12pcs		
Logo LED light	3pcs		

SR-808B SPECIFICATION

Size: 2130X1650X875MM

Seating	
Seating Capacity	2 Persons
Lounge	1 persons
Dimensions/Weight/ Container load	
Product dimension	2130mmx1650mmx875mm
Packing dimension	2230mmx1750mmX975mm
Weight - Dry/Filled	255KG/ 1050KG
Water capacity	210US gallon/795L
Container load	6pcs/20ft., 13pcs/40ft
Shell	
Shell colors	10 color available
Shell material	US Aristech Acrylic
Pumps (UL,CE, KC approved)	
Jet pump (two-speed)	1*2.0HP
Air blower	N/A
Electrics	
Control system	US Balboa system
Power supply	220V/50HZ
Heater (America Balboa brand)	2KW/220-240VAC
Underwater lighting	5 LED
Jet Configurations	
Jets total (pc)	23pcs
5.0 inches Massage jets (pc)	1pc
3.5inches Massage jets (pc)	11pcs
1.0inches Massage jets (pc)	11pcs
Air jets (pc)	N/A
Filtration	
Top mount filter	1pc
Effective Filtration Area	100 sq. ft.
Ozone Generator	50mg/h
Features	
Water diverter(pc)	1
Air regulator(pc)	2
2inches Suctions (pc)	2
Drain valve (pc)	1
EVA Headrest pillows(pc)	3
Support frame	#304 thickening Stainless steel
Overflow outlet (pc)	N/A
PVC Skirt:	Natural/brown/grey available
Black ABS corner with LEDs:	Yes
ABS base:	1



High quality
material Modern
spa culture
Excellent impression
New bathing experience

SR-808C SPECIFICATION

Size: 2130X1650X780MM

Seating	
Seating Capacity	2 Persons
Lounge	1 persons

Dimensions/Weight/ Container load	
Product dimension	2130mmx1650mmx780mm
Packing dimension	2230mmx1750mmX880mm
Weight - Dry/Filled	225KG/ 1020KG
Water capacity	210US gallon/795L
Container load	6pcs/20ft; 18pcs/40ft

Shell	
Shell colors	10 color available
Shell material	US Aristech Acrylic

Pumps (UL, CE, KC approved)	
Jet pump (two-speed)	1*2.0HP
Air blower	N/A

Electrics	
Control system	US Balboa system
Power supply	220V/50HZ
Heater (America Balboa brand)	2KW/220-240VAC
Underwater lighting	5*LED

Jet Configurations	
Jets total (pc)	23pcs
5.0 inches Massage jets (pc)	1pc
3.5inches Massage jets (pc)	11pcs
1.0inches Massage jets (pc)	11pcs
Air jets (pc)	N/A

Filtration	
Top mount filter	1pc
Effective Filtration Area	100 sq. ft.
Ozone Generator	50mg/h

Features	
Water diverter(pc)	1
Air regulator(pc)	2
2inches Suctions (pc)	2
Drain valve (pc)	1
EVA Headrest pillows(pc)	3
Support frame	#304 thickening Stainless steel
Overflow outlet (pc)	N/A
PVC Skirt	Natural/brown/grey available
ABS base	N/A



Designed To Raise Your Standard Of Living



SR-807A SPECIFICATION

Size: 1850X1250X780MM

Seating	
Seating Capacity	2 Persons
Lounge	1 persons

Dimensions/Weight/ Container load	
Product dimension	1850mmx1250mmx780mm
Packing dimension	1950mmx1350mmX880mm
Weight - Dry/Filled	215KG/ 1115KG
Water capacity	237 US Gallon/ 900Liters
Container load	8pcs/ 20ft; 24pcs/ 40ft

Shell	
Shell colors	10 color available
Shell material	US Aristech Acrylic

Pumps (UL, CE, KC approved)	
Jet pump (two-speed)	1*2.0HP
Air blower	N/A

Electrics	
Control system	US Balboa system (GS100±VL260)
Power supply	220V/50HZ
Heater (America Balboa brand)	2KW/220-240VAC
Underwater lighting	5*LED

Jet Configurations	
Jets total (pc)	16pcs
3.0inches Massage jets (pc)	3pcs
1.0inches Massage jets (pc)	13pcs
Air jets (pc)	N/A

Filtration	
Top mount filter	1pc
Effective Filtration Area	100 sq. ft.
Ozone Generator	50mg/h

Features	
Water diverter(pc)	1pc
Air regulator(pc)	1pc
1.5inches Suctions (pc)	1pc
Drain valve (pc)	1pc
EVA Headrest pillows(pc)	1pc
Support frame	#304 thickening Stainless steel
Overflow outlet (pc)	N/A
Skirt (Exclusive for New Eco Series)	Brown/Grey /Coffee color
Black ABS corner with LED (Exclusive for this model)	1set
ABS base	1set



Mars series

*THERAPY FOR
BODY AND SOUL*



SR-8110A

SPECIFICATION
Size: 2300*2300*940MM

Seating	
Seating Capacity	3 Persons
Lounge	2 persons

Dimensions/Weight/ Container load	
Product dimension	2300*2300*940mm
Packing dimension	2320*960*2450mm
Weight - Dry/Filled	510KG/1760KG
Water capacity	330US Gallon/1250Liters
Container load	5pcs/20ft; 12pcs/40ft

Shell	
Shell colors	8 color available
Shell material	US Aristech Acrylic

Pumps (UL, CE, KC approved)	
Jet pump 1	2.0HP
Jet pump 2	2.0HP
Jet pump 3	2.0HP
Circulation pump	0.5HP
Air blower	N/A

Electrics	
Control system	US Balboa system (BP6013G3+TP600B)
Power supply	230V/50Hz 1phase; 380V 50Hz 3phases;
Max power consumption	7.9KW 34A 230V/50Hz
Heater (America Balboa brand)	3KW/220-240VAC
Underwater lighting	5" LED

Jet Configurations (Continental series)	
Jets total (pc)	65
7.5 inches multiple massage jet (pc)	2
5 inches Massage jets (pc)	5
3.5 inches Massage jets (pc)	34
2 inches Massage jets (pc)	24
1 inches Massage jets (pc)	N/A
Air jets with LED (pc)	N/A

Filtration & Sterilization	
Top mount filter	2pcs
Effective Filtration Area	100 sq. ft.
Ozone Generator	200mg/h

Additional equipments	
Water diverter 2inches (pc)	3
Air regulator 1 inches (pc)	0
Waterfall with 1" controller (pc) Optio	2
Fountain with 1" controller (pc) Option	3
2inches Suctions (pc)	6
Drain valve (pc)	1
Headrest pillows (pc)	4
Ice box (pc)	1
Support frame	#304 thickening Stainless steel
Overflow outlet (pc)	1
WPS Skirt:	H03 H06 H19 H21A
ABS base:	1

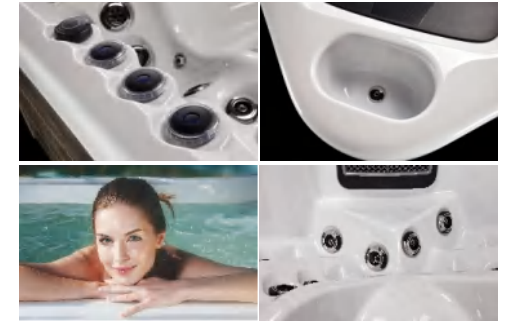

SR-8112B

SPECIFICATION
Size: 2200X2200X940MM

Seating	
Seating Capacity	3 Persons
Lounge	2 persons

Dimensions/Weight/ Container load	
Product dimension	2200mmx2200mmx940mm
Packing dimension	2220mmx960mmx2350mm
Weight - Dry/Filled	450KG/1600KG
Water capacity	305US Gallon/ 1150Liters
Container load	5pcs/20ft; 12pcs/40ft

Shell	
Shell colors	8color available
Shell material	US Aristech Acrylic

Pumps (UL, CE, KC approved)	
Jet pump 1	2.0HP
Jet pump 2	2.0HP
Jet pump 3	2.0HP
Circulation pump	0.5HP
Air blower	N/A

Electrics	
Control system	America Balboa control 230V/50Hz 1phase; 380V 50Hz 3phases;
Power supply	230V/50Hz 1phase; 380V 50Hz 3phases;
Max power consumption:	7.9KW34A 230V/50Hz
Heater (America Balboa brand)	3KW/220-240VAC
Underwater lighting	5"LED

Jet Configurations (Continental series)	
Jets total (pc)	60
7.5 inches multiple massage jet (pc)	2
5 inches Massage jets (pc)	6
3.5 inches Massage jets (pc)	37
2 inches Massage jets (pc)	15
1 inches Massage jets (pc)	N/A
Air jets with LED (pc)	N/A

Filtration & Sterilization	
Top mount filter	2pcs
Effective Filtration Area	100 sq. ft.
Ozone Generator	200mg/h

Additional equipments	
Water diverter 2inches (pc)	3
Air regulator 1 inches (pc)	1
Waterfall with 1" controller (pc) Option	2
Fountain with 1" controller (pc) Option	3
2inches Suctions (pc)	5
Drain valve (pc)	1
Headrest pillows (pc)	3
Ice box (pc)	1
Support frame	#304 thickening Stainless steel
Overflow outlet (pc)	1
WPS Skirt:	H03 H06 H19 H21A
ABS base:	1



SR-8113B

SPECIFICATION
Size: 2100X2100X940MM

Seating	
Seating Capacity	3 Persons
Lounge	2 persons
Dimensions/Weight/ Container load	
Product dimension	2100*2100*940mm
Packing dimension	2120*960*2250mm
Weight - Dry/Filled	410KG/1510KG
Water capacity	290US Gallon/1100Liters
Container load	5pcs/20ft; 12pcs/40ft
Shell	
Shell colors	8 color available
Shell material	US Aristech Acrylic
Pumps (UL,CE, KC approved)	
Jet pump 1	3.0HP
Jet pump 2	3.0HP
Jet pump 3	N/A
Circulation pump	0.5HP
Air blower	N/A
Electrics	
Control system	US Balboa system (BP6013G2+TP600A)
Power supply	230V/50Hz 1phase; 380V 50Hz 3phases;
Max power consumption	7.9KW 34A 230V/50Hz
Heater (America Balboa brand)	3KW/220-240VAC
Underwater lighting	5* LED

Jet Configurations (Continental series)

Jets total (pc)	59
7.5 inches multiple massage jet (pc)	1
5 inches Massage jets (pc)	6
3.5 inches Massage jets (pc)	37
2 inches Massage jets (pc)	15
1 inches Massage jets (pc)	N/A
Air jets with LED (pc)	N/A

Filtration & Sterilization

Top mount filter	2pcs
Effective Filtration Area	100 sq. ft.
Ozone Generator	200mg/h

Additional equipments

Water diverter 2inches (pc)	2
Air regulator 1 inches (pc)	1
Waterfall with 1" controller (pc) Optio	2
Fountain with 1" controller (pc) Option	3
2inches Suctions (pc)	4
Drain valve (pc)	1
Headrest pillows(pc)	3
Ice box(pc)	N/A
Support frame	#304 thickening Stainless steel
Overflow outlet (pc)	1
WPS Skirt	H03 H06 H19 H21A
ABS base	1



SR-8114B

SPECIFICATION
Size: 2000X2000X920MM

Seating	
Seating Capacity	2 Persons
Lounge	2 persons

Dimensions/Weight/ Container load	
Product dimension	2000*2000*920mm
Packing dimension	2020*940*2150mm
Weight - Dry/Filled	380KG/1380KG
Water capacity	265US Gallon/1000Liters
Container load	5pcs/20ft; 12pcs/40ft

Shell	
Shell colors	10 color available
Shell material	US Aristech Acrylic

Pumps (UL, CE, KC approved)	
Jet pump 1	3.0HP
Jet pump 2	3.0HP
Jet pump 3	N/A
Circulation pump	0.5HP
Air blower	N/A

Electrics	
Control system	US Balboa system (BP6013G2+ TP600A)
Power supply	230V/50Hz 1phase; 380V 50Hz 3phases;
Max power consumption	7.9KW 34A 230V/50Hz
Heater (America Balboa brand)	3KW/220-240VAC
Underwater lighting	5" LED

Jet Configurations (Continental series)	
Jets total (pc)	50
7.5 inches multiple massage jet (pc)	0
5 inches Massage jets (pc)	4
3.5 inches Massage jets (pc)	32
2 inches Massage jets (pc)	14
Air jets with LED (pc)	N/A

Filtration & Sterilization	
Top mount filter	2pcs
Effective Filtration Area	100 sq. ft.
Ozone Generator	200mg/h

Additional equipments	
Water diverter 2inches (pc)	2
Air regulator 1 inches (pc)	3
Waterfall with 1" controller (pc) Optio	2
Fountain with 1" controller (pc) Option	2
2inches Suctions (pc)	5
Drain valve (pc)	1
Headrest pillows(pc)	2
Ice box(pc)	1
Support frame	#304 thickening Stainless steel
Overflow outlet (pc)	1
WPS Skirt:	H03 H06 H19 H21A
ABS base:	1

SPA

Quality of life. It's the sum of your health and your happiness. It's the freedom of taking your life in may dir ction of your choice..... and know that at the end of, the daey the best place on earth is right here, in the home you've created. That's what owning a Sunrans Spa all about. Transporting you that last bit of the way home. Whether it's the mind-soothing end to your workday, the muscle-soothing phase of your workout, or the soul-soothing relaxation once the kids are tucked in bed.

Discover of yourself the many therapeutic benefits of our incomparable spa designs. And see how with a Sunrans Spa, you're raising your standards for luxury.



SR-8115B

SPECIFICATION
Size: 2200X1650X860MM

Seating	
Seating Capacity	1 Persons
Lounge	2Persons

Dimensions/Weight/ Container load	
Product dimension	2200*1650*860mm
Packing dimension	2220*880*1800mm
Weight - Dry/Filled	310KG/1260KG
Water capacity	250US Gallon/950Liters
Container load	6pcs/20ft; 13pcs/40ft

Shell	
Shell colors	
Shell material	S Aristech Acrylic

Pumps (UL, CE, KC approved)	
Jet pump 1	2.0HP
Jet pump 2	2.0HP
Jet pump 3	N/A
Circulation pump	0.5HP
Air blower	N/A

Electrics	
Control system	US Balboa system (BP6013G2+ TP600A)
Power supply	230V/50Hz 1phase; 380V 50Hz 3phases;
Max power consumption	6.4KW 28A 230V/50Hz
Heater (America Balboa brand)	3KW/220-240VAC
Underwater lighting	5" LED

Jet Configurations (Continental series)	
Jets total (pc)	48
7.5 inches multiple massage jet (pc)	0
5 inches Massage jets (pc)	5
3.5 inches Massage jets (pc)	30
2 inches Massage jets (pc)	13
1 inches Massage jets (pc)	N/A
Air jets with LED (pc)	N/A

Filtration & Sterilization	
Top mount filter	2pcs
Effective Filtration Area	100 sq. ft.
Ozone Generator	200mg/h

Additional equipments	
Water diverter 2inches (pc)	2
Air regulator 1 inches (pc)	0
Waterfall with 1" controller (pc) Optio	1
Fountain with 1" controller (pc) Option	3
2inches Suctions (pc)	4
Drain valve (pc)	1
Headrest pillows(pc)	3
Ice box(pc)	N/A
Support frame	#304 thickening Stainless steel
Overflow outlet (pc)	1
WPS Skirt:	H03 H06 H19 H21A
ABS base:	1





Helios series

Ergonomically designed using therapeutic principles, each spa fits the contours of your body providing proper lumbar support and maximizing comfort while the jets melt away stress and muscle strain. Submersion in warm water causes blood vessels to dilate, increasing blood flow to body tissues.

SR-8171 SPECIFICATION

Size: 2300X2300X940MM

Seating	
Seating Capacity	4 Persons
Lounge	1 persons

Dimensions/Weight/ Container load	
Product dimension	2300*2300*940mm
Packing dimension	2320*960*2450mm
Weight - Dry/Filled	460KG/1710KG
Water capacity	330US Gallon/1250Liters
Container load	5pcs/20ft; 12pcs/40ft

Shell	
Shell colors	6 color available
Shell material	US Aristech Acrylic

Pumps (UL, CE, KC approved)	
Jet pump 1	3.0HP
Jet pump 2	3.0HP
Jet pump 3	3.0HP
Circulation pump	0.5HP
Air blower	N/A

Electrics	
Control system	US Balboa system US Balboa control
Max power consumption:	10150Watt 44.1A in 220V 50Hz
Heater (US Balboa brand)	3KW/220-240VAC
Underwater lighting	5" LED

Jet Configurations (Continental series)	
Jets total (pc)	63
7.5 inches multiple massage jet (pc)	2
5.0 inches Massage jets (pc)	15
3.5 inches Massage jets (pc)	24
2.0 inches Massage jets (pc)	22
Air jets (pc)	N/A

Filtration	
Top mount filter (pc)	2
Effective Filtration Area	100 sq. ft.
Ozone Generator	200mg/h

Additional equipments	
Water diverter (pc)	2
Air regulator (pc)	4
2inches Suctions (pc)	5
Drain valve (pc)	1
Cup holder with LED (pc)	3
EVA Headrest pillows (pc)	3
Support frame	#304 Stainless steel
Overflow outlet (pc)	N/A
PVC Skirt:	Dark grey H24A
ABS base:	1



SR-8172

SPECIFICATION
Size: 2300*2300*940MM

Seating	
Seating Capacity	6 Persons
Lounge	0 persons
Dimensions/Weight/ Container load	
Product dimension	2300*2300*940mm
Packing dimension	2320*960*2450mm
Weight - Dry/Filled	460KG/1710KG
Water capacity	330US Gallon/1250Liters
Container load	5pcs/20ft; 12pcs/40ft
Shell	
Shell colors	6 color available
Shell material	US Aristech Acrylic
Pumps (UL,CE, KC approved)	
Jet pump 1	3.0HP
Jet pump 2	3.0HP
Jet pump 3	3.0HP
Circulation pump	0.5HP
Air blower	N/A
Electrics	
Control system	US Balboa system US Balboa control
Max power consumption:	10150Watt 44. 1A in 220V 50Hz
Heater (US Balboa brand)	3KW/220-240VAC
Underwater lighting	5" LED
Jet Configurations (Continental series)	
Jets total (pc)	62
7.5 inches multiple massage jet (pc)	2
5.0 inches Massage jets (pc)	17
3.5 inches Massage jets (pc)	28
2.0 inches Massage jets (pc)	15
Air jets (pc)	N/A
Filtration	
Top mount filter(pc)	2
Effective Filtration Area	100 sq. ft.
Ozone Generator	200mg/h
Additional equipments	
Water diverter (pc)	2
Air regulator (pc)	4
2inches Suctions (pc)	5
Drain valve (pc)	1
Cup holder with LED (pc)	4
EVA Headrest pillows(pc)	3
Support frame	#304 Stainless steel
Overflow outlet (pc)	N/A
PVC Skirt:	Dark grey H24A
ABS base:	1



SR-8173

SPECIFICATION
Size: 2100X2100X900MM

Seating	
Seating Capacity	4 Persons
Lounge	1 persons
Dimensions/Weight/ Container load	
Product dimension	2100*2100*900mm
Packing dimension	2120*920*2250mm
Weight - Dry/Filled	380KG/1480KG
Water capacity	290US Gallon/1100Liters
Container load	6pcs/20ft; 13pcs/40ft
Shell	
Shell colors	6 color available
Shell material	US Aristech Acrylic
Pumps (UL,CE, KC approved)	
Jet pump 1	3.0HP
Jet pump 2	3.0HP
Jet pump 3	N/A
Circulation pump	0.5HP
Air blower	N/A
Electrics	
Control system	US Balboa control
Max power consumption:	7.9KW 34A 230V 50Hz
Heater (US Balboa brand)	3KW/220-240VAC
Underwater lighting	5" LED
Jet Configurations (Continental series)	
Jets total (pc)	54
7.5 inches multiple massage jet (pc)	1
5.0 inches Massage jets (pc)	15
3.5 inches Massage jets (pc)	20
2.0 inches Massage jets (pc)	18
Air jets (pc)	N/A
Filtration	
Top mount filter(pc)	2
Effective Filtration Area	100 sq. ft.
Ozone Generator	200mg/h
Additional equipments	
Water diverter 2inches (pc)	2
Air regulator 1 inches (pc)	4
Waterfall with 1" controller (pc) Option	1
Fountain with 1" controller (pc) Option	1
2inches Suctions (pc)	5
Drain valve (pc)	1
Headrest pillows(pc)	3
Ice box(pc)	N/A
Support frame	#304 thickening Stainless steel
Overflow outlet (pc)	1
WPS Skirt:	Dark grey H24A
ABS base:	1



SR-8174

SPECIFICATION
Size: 2100*2100*900MM

Seating	
Seating Capacity	6 Persons
Lounge	0 persons

Dimensions/Weight/ Container load	
Product dimension	2100*2100*900mm
Packing dimension	2120*920*2250mm
Weight - Dry/Filled	380KG/1480KG
Water capacity	290US Gallon/1100Liters
Container load	6pcs/20ft; 13pcs/40ft

Shell	
Shell colors	6 color available
Shell material	US Aristech Acrylic

Pumps (UL, CE, KC approved)	
Jet pump 1	3.0HP
Jet pump 2	3.0HP
Jet pump 3	N/A
Circulation pump	0.5HP
Air blower	N/A

Electrics	
Control system	US Balboa control
Max power consumption:	7900Watt 34.3A in 220V 50Hz
Heater (US Balboa brand)	3KW/220-240VAC
Underwater lighting	5" LED

Jet Configurations (Continental series)	
Jets total (pc)	50
7.5 inches multiple massage jet (pc)	1
5.0 inches Massage jets (pc)	15
3.5 inches Massage jets (pc)	24
2.0 inches Massage jets (pc)	10
Air jets (pc)	N/A

Filtration	
Top mount filter(pc)	2
Effective Filtration Area	100 sq. ft.
Ozone Generator	200mg/h

Additional equipments	
Water diverters(pc)	2
Air regulator (pc)	4
2inches Suctions (pc)	5
Drain valve (pc)	1
Cup holder with LED (pc)	4
EVA Headrest pillows(pc)	3
Support frame	#304 Stainless steel
Overflow outlet (pc)	N/A
PVC Skirt:	Dark grey H24A
ABS base:	1



SR-8175

SPECIFICATION
Size: 2200X2200X940MM

Seating	
Seating Capacity	3 Persons
Lounge	2 persons

Dimensions/Weight/ Container load	
Product dimension	2200*2200*940mm
Packing dimension	2220*960*2350mm
Weight - Dry/Filled	410KG/1510KG
Water capacity	290US Gallon/1100Liters
Container load	5pcs/20ft; 12pcs/40ft

Shell	
Shell colors	6 color available
Shell material	US Aristech Acrylic

Pumps (UL, CE, KC approved)	
Jet pump 1	3.0HP
Jet pump 2	3.0HP
Jet pump 3	N/A
Circulation pump	0.5HP
Air blower	N/A

Electrics	
Control system	US Balboa system
Max power consumption	7.9KW 34A 230V/50Hz
Heater (America Balboa brand)	3KW/220-240VAC
Underwater lighting	5" LED

Jet Configurations (Continental series)	
Jets total (pc)	63
7.5 inches multiple massage jet (pc)	1
5 inches Massage jets (pc)	4
3.5 inches Massage jets (pc)	25
2 inches Massage jets (pc)	26
Air jets with LED (pc)	N/A

Filtration & Sterilization	
Top mount filter	2pcs
Effective Filtration Area	100 sq. ft.
Ozone Generator	200mg/h

Additional equipments	
Water diverter 2inches (pc)	2
Air regulator 1 inches (pc)	4
2inches Suctions (pc)	5
Drain valve (pc)	1
Headrest pillows(pc)	3
Cup holder with LED (pc)	3
Support frame	#304 Stainless steel
Overflow outlet (pc)	N/A
WPS Skirt:	Dark grey H24A
ABS base:	1





Gaea series

Using a SPA on a regular basis

improves quality of life.

When body and spirit are in harmony, well-being comes of its own accord.



SR-877 SPECIFICATION Size: 2200X2200X920MM

Seating		Jet Configurations	
Seating Capacity	3 Persons	Jets total (pc)	50
Lounge	2 persons	5.0inches Massage jets (pc)	4
Dimensions/Weight/ Container load		3.5inches Massage jets (pc)	13
Product dimension	2200mmx2200mmx920mm	1.0inches Massage jets (pc)	33
Packing dimension	2300mmx2300mmx1020mm	Filtration	
Weight - Dry/Filled	385KG/1635KG	High-efficiency Filter (3 filters)	Top mount filters
Water capacity	330US Gallon/1250Liters	Effective Filtration Area	150 sq. ft.
Container load	5pcs/20ft; 10pcs/40ft	Ozone Generator	50mg/h
Shell		Features	
Shell colors	10 color available	2inches Water diverter (pc)	1
Shell material	Aristech Acrylic	1inch Air regulator (pc)	2
Pumps (UL, CE, KC approved)		2inches Suctions (pc)	4
Jet pump 1	2.0HP	Gate valves (pc)	2
Jet pump 2	2.0HP	Drain valve (pc)	1
Circulation pump	0.53HP	EVA Headrest pillows (pc)	3
Electrics		Support frame	#304 Stainless steel
Control system	America Balboa control	Overflow outlet (pc)	1
Max power consumption:	6500Watt 29.5A in 220V 50Hz	Skirt:	Brown/ Grey / Black color
Heater (America Balboa brand)	3KW/220-240VAC		
Underwater lighting	5' LED		

Relaxation from here.
Hydrotherapy brings you healthier body.
Enjoy the massage, enjoy the life

SR-878 SPECIFICATION
 Size: 2200X2200X920MM

Seating	
Seating Capacity	6 Persons
Lounge	N/A
Dimensions/Weight/ Container load	
Product dimension	2200mm×2200mm×920mm
Packing dimension	2300mm×2300mm×1020mm
Weight - Dry/Filled	385KG/1635KG
Water capacity	330US Gallon/1250Liters
Container load	5pcs/20ft; 10pcs/40ft
Shell	
Shell colors	10 color available
Shell material	Aristech Acrylic
Pumps (UL, CE, KC approved)	
Jet pump 1	2.0HP
Jet pump 2	2.0HP
Circulation pump	0.53HP

Electrics	
Control system	America Balboa control
Max power consumption:	6440W 28A in 230V/50Hz
Heater (America Balboa brand)	3KW/220-240VAC
Underwater lighting	5"LED
Jet Configurations	
Jets total (pc)	40
Massage jets 5" (pc)	3
Massage jets 3.5" (pc)	11
Massage jets 1" (pc)	26

Filtration	
High-efficiency Filter (3 filters)	Top mount filters
Effective Filtration Area	150 sq. ft.
Ozone Generator	50mg/h

Features	
2" Water diverter with LED (pc)	2
Air regulator (pc)	2
2" Suctions (pc)	4
Gate valves (pc)	2
Drain valve (pc)	1
EVA Headrest pillows (pc)	4
Support frame	#304 Stainless steel
Overflow outlet (pc)	1
Skirt:	Brown/ Grey / Black color



SR-879 SPECIFICATION
 Size: 2200X2200X920MM

Seating	
Seating Capacity	5 Persons
Lounge	1 persons
Dimensions/Weight/ Container load	
Product dimension	2200mm×2200mm×920mm
Packing dimension	2300mm×2300mm×1020mm
Weight - Dry/Filled	385KG/1635KG
Water capacity	330US Gallon/1250Liters
Container load	5pcs/20ft; 10pcs/40ft
Shell	
Shell colors	10 color available
Shell material	Aristech Acrylic
Pumps (UL, CE, KC approved)	
Jet pump 1	2.0HP
Jet pump 2	2.0HP
Circulation pump	0.53HP

Jet Configurations	
Jets total (pc)	45
Massage jets 5" (pc)	5
Massage jets 3.5" (pc)	10
Massage jets 1" (pc)	30

Filtration	
High-efficiency Filter (3 filters)	Top mount filters
Effective Filtration Area	150 sq. ft.
Ozone Generator	50mg/h

Electrics	
Control system	America Balboa control
Max power consumption:	6500Watt 28A in 220V 50Hz
Heater (America Balboa brand)	3KW/220-240VAC
Underwater lighting	5" LED

Features	
2 inches Water diverter (pc)	2
1 inch Air regulator (pc)	2
2 inches Suctions (pc)	5
Gate valves (pc)	2
Drain valve (pc)	1
EVA Headrest pillows (pc)	3
Support frame	#304 Stainless steel
Overflow outlet (pc)	1
PVC Skirt:	Brown/ Grey / Black color

*DESIGNED
TO RAISE YOUR
STANDARD
OF LIVING QUALITY OF LIFE*

Classic Series



Stainless Steel Jets make the outlook more grace-Beauty

Match the color of your spa with the options of your choice for a distinctive combination. That's truly your own.

SR-862 SPECIFICATION Size: 2300X2300X950MM

Seating	
Seating Capacity	3 Persons
Lounge	2 persons
Dimensions/Weight/ Container load	
Product dimension	2300mmx2300mm950mm
Packing dimension	2400*2400*1110mm
Weight - Dry/Filled	450KG/ 1950KG
Water capacity	396 US Gallon/ 1500Liters
Container load	0pc/20ft; 10pcs/40ft
Shell	
Shell colors	10 color available
Shell material	Aristech Acrylic
Pumps (UL, CE, KC approved)	
Jet pump 1	2.0HP
Jet pump 2	2.0HP
Jet pump 3	2.0HP
Circulation pump	0.53HP
Air blower	1.5HP
Electrics	
Control system	America Balboa control
Max power consumption:	8700Watt 39.5A in 220V 50Hz
Heater (America Balboa brand)	3KW/220-240VAC
Underwater lighting	5 LED
Jet Configurations	
Jets total (pc)	91
Massage jets (pc)	81
Air jets (pc)	10
Filtration	
Filter	Top mount filters
Effective Filtration Area	100 sq. ft.
Ozone Generator	50mg/h
Features	
Water diverter(pc)	2
Air regulator(pc)	2
Suctions (pc)	4
Gate valves (pc)	8
Drain valve (pc)	1
Headrest pillows(pc)	3
Support frame	#304 Stainless steel
Overflow outlet (pc)	1
Skirt:	Brown/ Grey / Black color

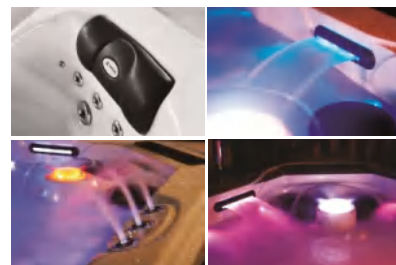

That's why we've designed a number of spa shapes and sizes to fit beautifully in the setting of your home. Style and comfort truly come together in a Sunrans Spa.

Taste care in warm water. You can enjoy most wonderful and memorable experience in the world. Water flows over your body and fatigue can be removed completely.

Water can release working pressure and lets you be lost in most beautiful daydream.

SR-851 SPECIFICATION Size: 3800x2200x1050MM

Seating	
Seating Capacity	6 Persons
Lounge	4 Persons
Dimensions/Weight/ Container load	
Product dimension	3800mm×2200mm×1050mm
Packing dimension	3900mm×2300mm×1150mm
Weight - Dry/Filled	520KG/ 2370KG
Water capacity	488 US Gallon/ 1850Liters
Container load	1pc/20ft; 6pcs/ 40ft
Shell	
Shell colors	10 color available
Shell material	Aristech Acrylic
Pumps (UL, CE, KC approved)	
Jet pump 1	3.0HP
Jet pump 2	3.0HP
Jet pump 3	3.0HP
Circulation pump	1HP
Air blower	1.5HP
Electrics	
Control system	America Balboa control
Max power consumption:	11625W 52.9A in 220V/50Hz
Heater (America Balboa brand)	3KW/220-240VAC
Underwater lighting	5 LED
Jet Configurations	
Jets total (pc)	158
Massage jets (pc)	138
Air jets (pc)	20
Filtration	
Filter	front access filters
Effective Filtration Area	100 sq. ft.
Ozone Generator	50mg/h
Features	
Water diverter(pc)	4
Air regulator(pc)	4
Suctions (pc)	4
Gate valves (pc)	8
Drain valve (pc)	1
Headrest pillows(pc)	7
Support frame	#304 Stainless steel
Overflow outlet (pc)	1
Skirt:	Brown/ Grey / Black color





SR-876 SPECIFICATION
Size: 2400x2400x950MM



SR-843 SPECIFICATION
Size: 1850x1450x880MM



SR-842 SPECIFICATION
Size: 1950x1550x900MM



SR-852 SPECIFICATION
Size: 3800x2200x980MM



SR-830 SPECIFICATION
Size: 1900x1900x950MM



SR-828A SPECIFICATION
Size: 1900x1900x900MM



SR-841 SPECIFICATION
Size: 1950mmx1000mmx820mm

Seating							
Seating Capacity	5 Persons	0 Person	1 Persons	5 Persons	4 Persons	4 Persons	1 Persons
Lounge	2 Person	2 Persons	1 Person	3 Person	1 Person	0 Person	0 Persons
Dimensions/Weight/ Container load							
Product dimension	2400mmx2400mmx950mm	1850x1450x880mm	1950*1550*900mm	3800X2200X980mm	1900mmx1900mmx950mm	1900mmx1900mmx900mm	1950mmx1000mmx820mm
Packing dimension	2500mmx2500mmx1050mm	1950x1550x980mm	2050*1650*1000mm	3900mm x 2300mm x 1080mm	2000mmx2000mmx1050mm	2000mmx2000mmx1000mm	2050*1100*920mm
Weight - Dry/Filled	492KG/ 2053KG	320KG/ 1376KG	320KG/ 1376KG	510KG/ 3210KG	295KG/ 1169KG	295KG/ 1169KG	300KG/ 1070KG
Water capacity	405US Gallon/ 1561Liters	Approx158 US Gallon/ 600 Liters	279 US Gallon/ 1056 Liters	713 US Gallon/ 2700Liters	231 US Gallon/ 874Liters	231 US Gallon/ 874Liters	203 US Gallon/ 768Liters
Container load	8pcs/40HQ	7pcs/ 20ft; 15pcs/ 40ft	6pcs/ 20ft; 12pcs/ 40ft	2pcs/20ft; 6pcs/ 40ft	5pcs/20ft; 11pcs/40ft	5pcs/20ft; 12pcs/40ft	10pcs/ 20ft; 20pcs/ 40ft
Shell							
Shell colors	10 color available	10 color available	10 color available	10 color available	10 color available	10 color available	10 color available
Shell material	USA Aristech Acrylic	US Aristech Acrylic	Aristech Acrylic	Aristech Acrylic	Aristech Acrylic	USA Aristech Acrylic	Aristech Acrylic
Pumps (UL,CE, KC approved)							
Jet pump 1	2.0HP	2.0HP	2.0HP	3.0HP	2.0HP	3.0HP(two-speed)	2.0HP
Jet pump 2	2.0HP	-	--	3.0HP	2.0HP	--	--
Jet pump 3	3.0HP	-	--	3.0HP	--	--	--
Circulation pump	0.53HP	0.53HP	0.53HP	1.0HP	0.53HP		0.53HP
Air blower	1.5HP	N/A	N/A	1.5HP	1HP	N/A	1.0HP
Electrics							
Control system	Balboa Control System	Pulan smart control	America Balboa control	America Balboa control	America Balboa control	America Balboa control	America Balboa control
Max power consumption:	9775Watt 44.5A 220V 50Hz	5535Watt 25.1A in 220V 50Hz	5535Watt 25.1A in 220V 50Hz	11625W 52.9A in 220V/50Hz	6735Watt 30.6A in 220V 50Hz	5350Watt 24.3A in 220V 50Hz	5435Watt 24.7A in 220V 50Hz
Heater (America Balboa brand)	3KW	3KW/220-240VAC	3KW/220-240VAC	3KW/220-240VAC	3KW/220-240VAC	3KW/220-240VAC	3KW/220-240VAC
USA Balboa Heater	5" LED	5" LED	5" LED	5" LED		5" LED	5" LED
Underwater lighting	1.5HP				5" LED		
Jet Configurations							
Jets total (pc)	134	19	19	78	43	37	30
Massage jets(pc)	16	19			31	N/A	22
Massage jets 5" (pc)				6			8
Massage jets 3.5" (pc)			2	22			
Massage jets 3" (pc)						Front access filters	Front access filters
Massage jets 1" (pc)			17	34		100 sq. ft.	100 sq. ft.
Air jets(pc)		N/A	N/A	16		50mg/h	50mg/h
Filtration							
Filter	Front access filters	Top-mount filter	Front access filters	Top mount filters	Front access filters	2	1
Effective Filtration Area	100 sq. ft.	100 sq. ft.	100 sq. ft.	100 sq. ft.	100 sq. ft.	1	2
Ozone Generator	200mg/h	200mg/h	50mg/h	50mg/h	50mg/h	3	2
Features							
Water diverter(pc)	4	1	1	3	2	4	12
Air regulator(pc)	2	1	1	4	2	1	6
Suctions (pc)	4	2	2	6	3	no	1
Pop-up speaker			2			#304 Stainless steel	1
Water level LED light			12			1	#304 Stainless steel
Gate valves (pc)		4	6	2	6	Brown/ Grey / Black color	1
Drain valve (pc)	1	2	1	1	1		Brown/ Grey / Black color
Headrest pillows(pc)	3	2	2	3	3		
Support frame	#304 Stainless steel	#304 Stainless steel	#304 Stainless steel	#304 Stainless steel	#304 Stainless steel		
Overflow outlet (pc)	1	1	1	1	1		
Skirt:	Brown/ Grey / Black color	Brown/ Grey / Black color	Brown/ Grey / Black color	Brown/ Grey / Black color	Brown/ Grey / Black color		

ROUND SPA

Discover the soothing benefits of hydrotherapy, massage and aromatherapy; with spas designed to relieve stress and strains, and replenish energy.



SR-831

SPECIFICATION
Size: 2450X2450X980MM

Seating	
Seating Capacity	6 Persons
Lounge	0 persons

Dimensions/Weight/ Container load	
Product dimension	2450mmx2450mmx980mm
Packing dimension	2500mmx1003mmx2600mm
Weight - Dry/Filled	445KG/2005KG
Water capacity	412US Gallon/1560Liters
Container load	0pc/ 20ft; 8pcs/40ft

Shell	
Shell colors	10 color available
Shell material	Aristech Acrylic

Pumps (UL, CE, KC approved)	
Jet pump 1	2.0HP
Jet pump 2	2.0HP
Circulation pump	0.53HP
Air blower	1.5HP

Electrics	
Control system	America Balboa control
Max power consumption:	7300Watt 33.1A in 220V 50Hz
Heater (America Balboa brand)	3KW/220-240VAC
Underwater lighting	5" LED

Jet Configurations	
Total Stainless steel Jets (pc)	48
Massage jets (pc)	32
Air jets (pc)	16

Filtration	
Filter	Built-in filters
Effective Filtration Area	100 sq. ft.
Ozone Generator	50mg/h

Features	
Water diverter(pc)	2
Air regulator(pc)	4
Suctions (pc)	3
Gate valves (pc)	6
Drain valve (pc)	1
Headrest pillows(pc)	6
Support frame	#304 Stainless steel
Overflow outlet (pc)	1
Skirt:	Brown/ Grey / Black color

Putting Spa Therapy In A Whold New Light

SUNRANS Spas really shine at night with our underwater lighting. At the touch of a button, flood your tub with colour and create the perfect atmosphere for a night-time soak.



SR-865

SPECIFICATION
Size: 2350X2350X950MM

Seating	
Seating Capacity	6 Persons

Dimensions/Weight/ Container load	
Product dimension	2350mm*2350mm*950mm
Packing dimension	2400mmx1000mmx2500mm
Weight - Dry/Filled	380KG/ 1750KG
Water capacity	362US Gallon/ 1370Liters
Container load	0pc/ 20ft; 8pcs/40ft

Shell	
Shell colors	10 color available
Shell material	Aristech Acrylic

Pumps (UL, CE, KC approved)	
Jet pump 1	2.0HP
Jet pump 2	2.0HP
Circulation pump	0.53HP
Air blower	N/A

Electrics	
Control system	America Balboa control
Max power consumption:	7300Watt 33.1A in 220V 50Hz
Heater (America Balboa brand)	3KW/220-240VAC
Underwater lighting	5" LED

Jet Configurations	
Jets total (pc)	43
Massage jets (pc)	43
Air jets (pc)	N/A

Filtration	
Filter	Top mount filters
Effective Filtration Area	100 sq. ft.
Ozone Generator	50mg/h

Features	
Water diverter(pc)	2
Air regulator(pc)	1
Suctions (pc)	4
Gate valves (pc)	6
Drain valve (pc)	1pc
Headrest pillows(pc)	6pcs
Support frame	#304 Stainless steel
Overflow outlet (pc)	1pc
Fountain jets with LED:	3pcs
Skirt:	Brown/ Grey / Black color

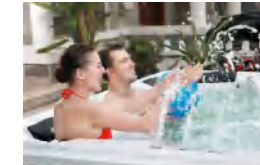

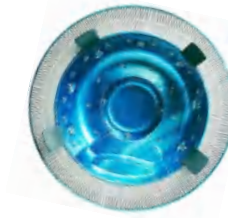

SR-818 SPECIFICATION
Size: 2200x2200x830MM



SR-875 SPECIFICATION
Size: □200*900MM



SR-840 SPECIFICATION
Size: 1800x1800x750MM

	SR-818	SR-875	SR-840
Seating			
Seating Capacity	5 Persons	5 Person	0 Persons
Lounge	0	0 Persons	2 Persons
Dimensions/Weight/ Container load			
Product dimension	2200mmx2200mmx830mm	□200*900mm	1800mmx1800mmx750mm
Packing dimension	2300mmx2300mmx930mm	2100*2100*1000mm	1900mmx1900mmx850mm
Weight - Dry/Filled	370KG/ 1411KG	350KG/ 1556KG	255KG / 1005 KG
Water capacity	275 US Gallon/ 1041Liters	319 US Gallon/ 1206 Liters	198 gallon / 750 liter
Container load	5pcs/20ft; 10pcs/40ft	5pcs/ 20ft; 10pcs/ 40ft	6 pcs / 20ft; 18 pcs / 40 ft
Shell			
Shell colors	10 color available	10 color available	10 color available
Shell material	Aristech Acrylic	Aristech Acrylic	Aristech Acrylic
Pumps (UL,CE, KC approved)			
Jet pump 1	3.0HP	2.0HP	2.0HP
Jet pump 2	--	2.0HP	--
Jet pump 3	--	--	--
Circulation pump	0.53HP	0.53HP	0.53HP
Air blower	1.0HP	N/A	1.0HP
Electrics			
Control system	America Balboa control	America Balboa control	America Balboa control
Max power consumption:	6340Watt 28.8A in 220V 50Hz	7200Watt 32.7A in 220V 50Hz	5435Watt 24.7A in 220V 50Hz
Heater (America Balboa brand)	3KW/220-240VAC	3KW/220-240VAC	3KW/220-240VAC
Underwater lighting	5□ LED	3□ LED	5□ LED
Jet Configurations			
PVC Jets total (pc)	29	34	28
Jets total (pc)	21	4	14
Massage jets(pc)	8	30	14
Air jets(pc)		N/A	
Filtration			
Filter	Built-in filters	Front access filters	"Built-in filters"
Effective Filtration Area	100 sq. ft.	100 sq. ft.	100 sq. ft.
Ozone Generator	50mg/h	50mg/h	50mg/h
Features			
Water diverter(pc)	--	1	no
Air regulator(pc)	--	1	no
Suctions (pc)	3	2	1
Pop-up speaker	--	1	
water level LED light	--	17	
Gate valves (pc)	6	6	2
Drain valve (pc)	1	1	1
Headrest pillows(pc)	4	3	no
Support frame	#304 Stainless steel	#304 Stainless steel	#304 Stainless steel
Overflow outlet (pc)	1	1	1
Skirt:	Brown/ Grey / Black color	Brown/ Grey / Black color	Brown/ Grey / Black color

Gazebo

We want Spa to be your favourite destination. So we design our Wooden Gazebo to include a variety of features that make your spa experience more relaxing and enjoyable. Enjoy less stress, more spa features and unsurpassed quality from the world's best-selling hot tub brand.



Spa: SR80061(SR881)
Gazebo: SR10D009(SR889)

INTERNATIONAL CERTIFICATION ISO 9001

CE RoHS Compliant CCC



SR10D007-2(SR892)
SIZE: 3000X3000X2800MM



SR10D009(SR889)
SIZE: 3300X3300X3000MM



SR10D011(SR891)
SIZE: 3000X3000X2800MM



SR10D003(SR881)
SIZE: 3300X3300X2850MM



SR10D004(SR888)
SIZE: 3000X3000X2800MM



SR10D005(SR896)
SIZE: 3000X3000X2800MM



SR10D001(SR883)
SIZE: 3000X3000X2900MM



SR10D002(SR889)
SIZE: 3300X3300X3000MM



SR10D001-2(SR885)
SIZE: 3000X3000X2850MM



SR10D006(SR893)
SIZE: 3000X3000X2800MM



SR10D007-1(SR892)
SIZE: 3000X3000X2800MM



SR10D007(SR892)
SIZE: 3000X3000X2800MM

INTERNATIONAL CERTIFICATION ISO 9001

CE RoHS Compliant CCC

SPA Control & Color Choices



Skirt Colors



Note: H11 H12 H13 available for SR805A SR806A SR808A/B SR832A/B only; H14 H15 H16 available for SR801A/B SR812A/B SR808C SR820A only;

Acrylic Colors

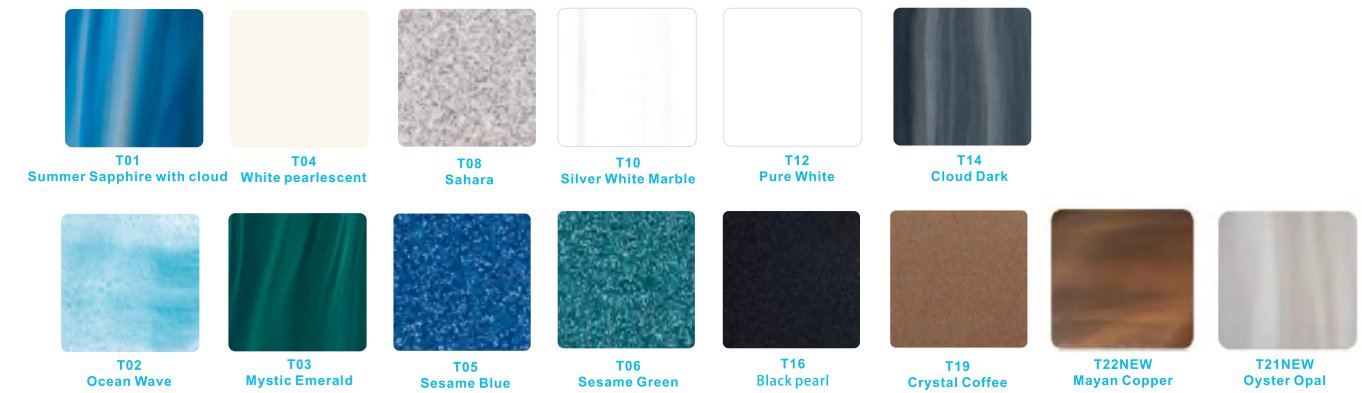

Cover Color Available

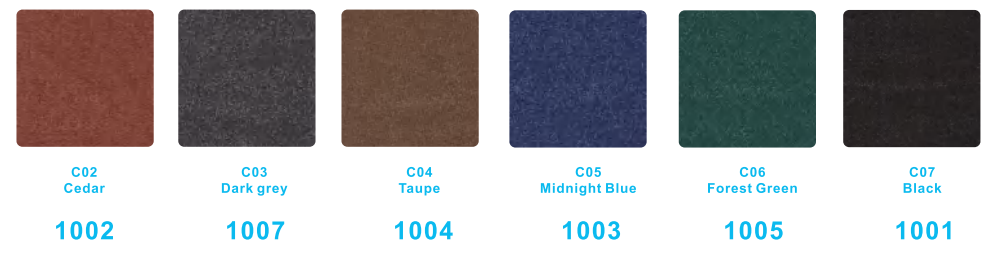

Luxury SPA/POOL Optional Equipments

Opt. 1
(Nordic Cover)

Opt. 13
(Auto Water in/drain System)



Opt. 2
(Hydraulic cover lifter)

Opt. 14
(Safty Rail for Walk in/out)

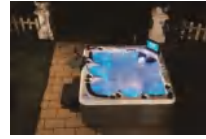

Opt. 3
(steps)
Hemlock wood type
Wood plastic type

Opt. 15
(Ipod Box)
Match for Balboa control
Play music with your mobile phone



Opt. 4
(Insulation on SPA body)

Opt. 16
(Waterproof TV)
17' TV/37' TV



Opt. 5
(Insulation for pipe)

Opt. 17
(DVD Player)
waterproof
(Include MP3/ MP4/ USB/ Aux input)



Opt. 7
(Water-Level LED Light & controller)

Opt. 18
(Pop-up Speaker)
Oval Shape Type
Round Shape Type



Opt. 8
(Waterfall with LED Light)

Opt. 19
(Update Balboa with Internet Control)
You can control your spa at anywhere
of the world with BP series



Opt. 9
(FRP base)

Opt. 10
(Change ABS jets into Stainless steel jets)

Opt. 11
(Aromatherapy Box)

Opt. 12
(Fountain with LED Light)



New Items, Coming up soon...



Located in Heyuan, Fourth production bases is in process of design and construction...