

EXHIBITION
STORAGE
WEDDING
MEETING
SPORT
CELEBRATION

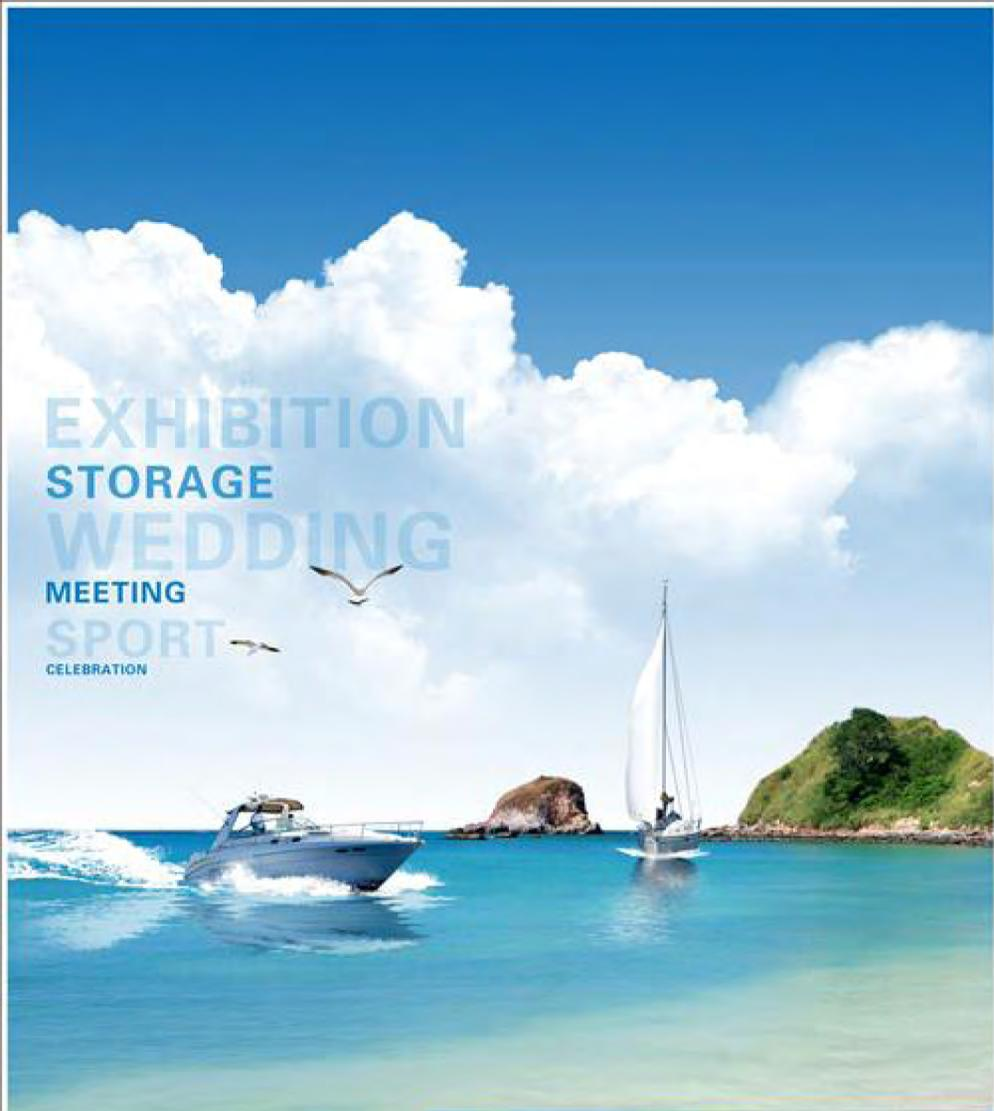

- ✦ Folding Tent
- ✦ Garden Umbrella
- ✦ Advertising Umbrella
- ✦ Golf Umbrella
- ✦ Banana Umbrella
- ✦ Beach Parasol



不锈钢六角蓬 Stainless Steel Dome Tent

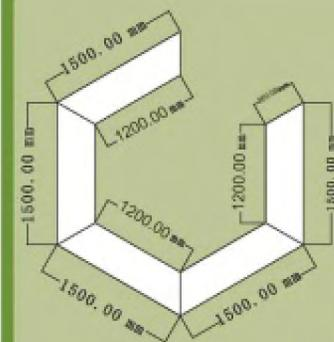

Dome Tent.Diameter:3m,Overall height:2.6m
 Table's pole profile:25*25*1.0mm.
 Round pole profile:30*30*1.0mm.
 Consist of five tables.
 Size of table:
 150L*26W*80Hcm.
 Frame material:Steel with white powder coated.

规格: 300X300X260MM 下脚管: 25X25X1.0MM 上圆管: 30X1.0MM



SPTDT1



SPTDT2



SPTDT3



SPTDT4



SPTDT5



SPTDT6



SPTDT7



SPTDT8



SPTDT9

3x6m 折叠帐篷 3x6m Folding Tent



架构 (Frame)

尺寸 (Size)

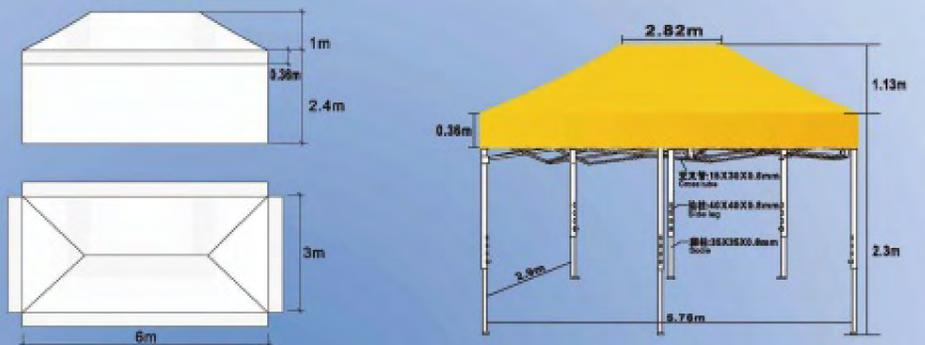

3X6M	豪华铝支架 Deluxe Aluminium	中档铝支架 Mid-range Aluminium	豪华钢支架 Deluxe Steel	中档钢支架 Mid-range Steel	普通铁支架 Ordinary Iron
边柱 Side leg	41X41X2.0mm	36X36X1.8mm	40X40X0.8mm	30X30X0.6mm	30X30X0.6mm
脚柱 Socle	36X36X1.8mm	31X31X1.7mm	35X35X0.8mm	25X25X0.6mm	25X25X0.6mm
交叉管 Cross tube	15X30X2.0/1.6mm	15X30X1.6/1.2mm	15X30X0.6mm	13X23X0.6mm	13X23X0.6mm
配件 Accessories	带加强圈, 全套塑料配件, 带铝件等配件, 聚酯三角布收边, 涤纶收边, 高致防晒。	带加强圈, 全套塑料配件, 带铝件等配件, 聚酯三角布收边, 涤纶收边, 高致防晒。	带加强圈, 铝球头, 大铁脚圈, 表面处理, 喷白油。	带加强圈, 全套塑料配件, 带铝件等配件, 喷白油。	加厚使用方管, 中能使用圆管并加套管增加强度, 加厚边布, 涤纶收边, 高致防晒。
可选布料 Optional fabric	420D牛津布, 厚度280 抗水压1000mm, 克重: 285g/㎡ 420D Oxford fabric, thickness: 280 Anti hydraulic pressure: 1000mm Gram: 285g/㎡	600*800牛津布, 厚度320g/㎡(1200mm, 克重: 313g/㎡) 600*800 oxford fabric, thickness: 320 Anti hydraulic pressure: 1000mm Gram: 313g/㎡	300D*300D 长丝布 克重: 125g/㎡ 聚酯, CPAI-84 CPAI-84 聚酯长纤维, AATCC-183 UV 50+ 水压: 800mm 300D*300D long fibre fabric, anti-filming standard: CPAI-84 uvioresistant: AATCC-183 UV 50+ Anti hydraulic pressure: 800mm Gram: 125g/㎡	300D*300D 聚酯布 克重: 180g/㎡ 聚酯, CPAI-84 600D 聚酯布, AATCC-183 UV 50+ 水压: 800mm 300D*300D polyester, anti-filming standard: CPAI-84 uvioresistant: AATCC-183 UV 50+ Anti hydraulic pressure: 800mm Gram: 180g/㎡	600D*800D 长丝布 克重: 325g/㎡ 聚酯, CPAI-84 600D 聚酯布, AATCC-183 UV 50+ 水压: 800mm 600D*800D polyester, anti-filming standard: CPAI-84 uvioresistant: AATCC-183 UV 50+ Anti hydraulic pressure: 800mm Gram: 225g/㎡

3x6m 折叠帐篷
3x6m Folding Tent



3x4.5m 折叠帐篷 3x4.5m Folding Tent



架构 (Frame)

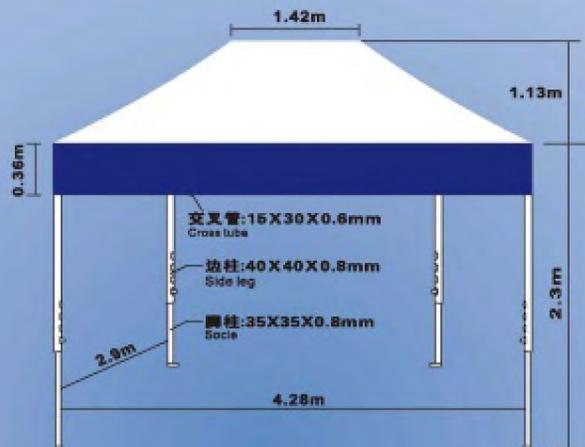

尺寸 (Size)

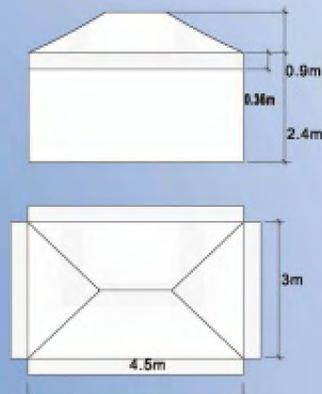

3X4.5M	豪华铝支架 Deluxe Aluminum	中档铝支架 Mid-range Alurid/Un	豪华钢支架 Deluxe Steel	中档钢支架 Mid-range Steel	普通铁支架 Ordinary Iron
边柱 Side leg	41X41X2.0mm	38X38X1.8mm	40X40X0.8mm	30X30X0.6mm	30X30X0.6mm
脚柱 Socle	36X36X1.8mm	31X31X1.7mm	35X35X0.8mm	25X25X0.6mm	25X25X0.6mm
交叉管 Cross tube	15X30X2.0/1.8mm	15X30X1.8/1.2mm	15X30X0.6mm	13X23X0.6mm	13X23X0.6mm
配件 Accessories	铝合金, 全套胶 撑管, 铝合金 配件, 直脚三角 铁脚, 圆脚铁脚, 尼龙绳等. reinforcing sleeve, plastic connection, aluminum base	铝合金, 全套胶 撑管, 铝合金 配件, 直脚三角 铁脚, 圆脚铁脚, 尼龙绳等. reinforcing sleeve, plastic connection, aluminum base	镀锌钢管, 圆球头, 大胶脚垫, 尼龙止 脚, 尼龙绳等. reinforcing sleeve, aluminum joint base	镀锌钢管, 全套胶 撑管, 圆球头, 大胶脚垫, 尼龙止 脚, 尼龙绳等. reinforcing sleeve, plastic connection	圆球头铁脚, 中 档铁脚, 直脚铁脚 圆球头铁脚, 尼龙 绳, 尼龙绳等或 尼龙绳等. Alurid use square tube middle axle use circular tube with mechanical spring
可选布料 Optional fabric	420D牛津布, 厚度280 织法1000mm, 克重: 225g/㎡ 420D牛津布 厚度280 Anti hydraulic pressure: 1000mm Gram: 225g/㎡	800*800D牛津布, 厚度 320织法1000mm, 克 重: 315g/㎡ 800*800D oxford fabric, thickness:320 Anti hydraulic pressure: 1000mm Gram:315g/㎡	3090*3090 涤纶布克 重: 125g/㎡ 耐晒, CPAI-84阻燃标准中档, AATCC-183 UV 50+ 水 压: 800MM 360D*360D long fibre fabric, anti-flaming standard:CPAI- 84 uvresistant: AATCC- 183 UV 50+ Anti hydraulic pressure: 800mm Gram: 125g/㎡	3090*3090 涤纶布克重: 180g/㎡ 耐晒, CPAI-84 标准 阻燃中档, AATCC- 183 UV 50+ 水压: 800MM 300D*300D polyester, anti-flaming standard:CPAI-84 uvresistant: AATCC-183UV 50+ Anti hydraulic pressure: 800mm Gram: 180g/㎡	8090*8090涤纶布 克重: 325g/㎡ 耐晒, CPAI-84耐 晒 阻燃中档, AATCC-183 UV 50+ 水压: 800MM 800D*800D polyester, anti-flaming standard:CPAI- 84 uvresistant: AATCC- 183 UV 50+ Anti hydraulic pressure: 800mm Gram: 325g/㎡

3x4.5m 折叠帐篷
3x4.5m Folding Tent



2x3m 折叠帐篷 2x3m Folding Tent



架构 (Frame)

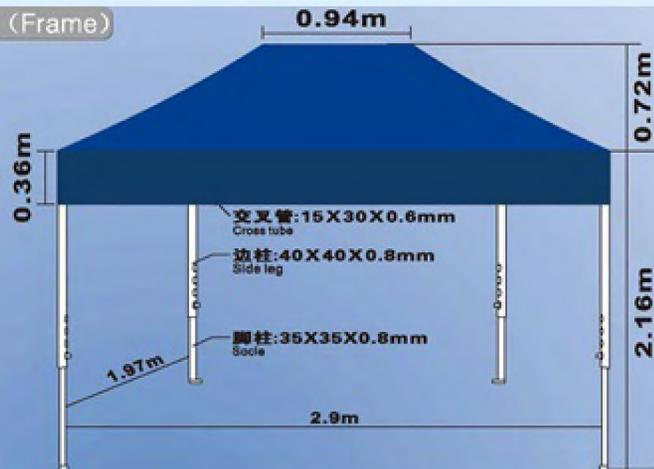

尺寸 (Size)

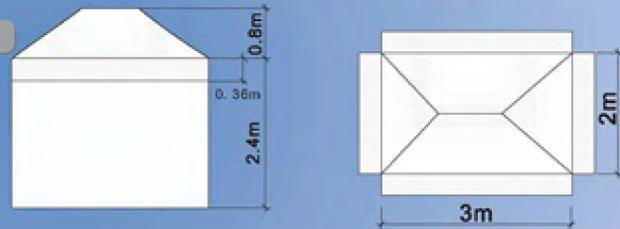

2x3m	豪华铝支架 Deluxe Aluminum	中档铝支架 Mid-range Aluminum	豪华钢支架 Deluxe Steel	中档钢支架 Mid-range Steel	普通铁支架 Ordinary Iron
边柱 Side leg	41X41X2.0mm	36X36X1.8mm	40X40X0.8mm	30X30X0.6mm	30X30X0.6mm
脚柱 Socle	36X36X1.8mm	31X31X1.7mm	35X35X0.8mm	25X25X0.6mm	25X25X0.6mm
交叉管 Cross tube	15X30X2.0/1.6mm	15X30X1.6/1.2mm	15X30X0.6mm	13X23X0.6mm	13X23X0.6mm
配件 Accessories	增加加强, 全塑料连接, 铝制底座。 增加加强, 全塑料连接, 铝制底座。 增加加强, 全塑料连接, 铝制底座。 增加加强, 全塑料连接, 铝制底座。 增加加强, 全塑料连接, 铝制底座。	增加加强, 全塑料连接, 铝制底座。 增加加强, 全塑料连接, 铝制底座。 增加加强, 全塑料连接, 铝制底座。 增加加强, 全塑料连接, 铝制底座。 增加加强, 全塑料连接, 铝制底座。	增加加强, 塑料连接, 铝制底座。 增加加强, 塑料连接, 铝制底座。 增加加强, 塑料连接, 铝制底座。 增加加强, 塑料连接, 铝制底座。 增加加强, 塑料连接, 铝制底座。	增加加强, 全塑料连接, 铝制底座。 增加加强, 全塑料连接, 铝制底座。 增加加强, 全塑料连接, 铝制底座。 增加加强, 全塑料连接, 铝制底座。 增加加强, 全塑料连接, 铝制底座。	增加加强, 全塑料连接, 铝制底座。 增加加强, 全塑料连接, 铝制底座。 增加加强, 全塑料连接, 铝制底座。 增加加强, 全塑料连接, 铝制底座。 增加加强, 全塑料连接, 铝制底座。
可选布料 Optional fabric	4200g 篷布, 厚度200 防水压1500mm, 克重: 230g/㎡ 4200 涤纶布, 厚度200 防水压200 Anti hydraulic pressure: 1500mm Gram: 230g/㎡	600-8000g 篷布, 厚度 310防水压1500mm, 克 重: 310g/㎡ 600*8000 Oxford fabric Thickness: 32g Anti hydraulic pressure: 1500mm Gram: 313g/㎡	3000*3000 篷布布, 克 重: 175g/㎡ CPAI-84 篷布, 克重: AA1CC-183 UV 50+ 水 压: 800mm 3000*3000 long fibre fabric anti-flaming standard: CPAI- 84 uv-resistant; AA1CC- 183 UV 50+ Anti hydraulic pressure: 800mm Gram: 175g/㎡	3000*3000 篷布布, 克 重: 180g/㎡ CPAI-84 篷布, 克重: AA1CC- 183 UV 50+ 水 压: 800mm 3000*3000 polyester anti-flaming standard: CPAI-84 uv-resistant; AA1CC-183UV 50+ Anti hydraulic pressure: 800mm Gram: 180g/㎡	6000*8000 篷布布, 克 重: 224g/㎡ CPAI-84 篷布, 克重: AA1CC-183 UV 50+ 水 压: 800mm 6000*8000 polyester, anti-flaming standard: CPAI- 84 uv-resistant; AA1CC- 183 UV 50+ Anti hydraulic pressure: 800mm Gram: 225g/㎡

3x3m 折叠帐篷 3x3m Folding Tent



3x3m 折叠帐篷

3x3m Folding Tent



2.5x2.5m 折叠帐篷 2.5x2.5m Folding Tent



尺寸 (Size)

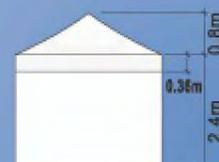
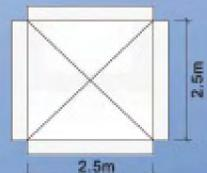

架构 (Frame)



2.5X2.5M	豪华铝支架 Deluxe Aluminium	中档铝支架 Mid-range Aluminium	豪华钢支架 Deluxe Steel	中档钢支架 Mid-range Steel	普通铁支架 Ordinary Iron
边柱 Side leg	41X41X2.0mm	36X36X1.8mm	40X40X0.8mm	30X30X0.6mm	30X30X0.6mm
脚柱 Bottle	36X36X1.8mm	31X31X1.7mm	35X35X0.8mm	25X25X0.6mm	25X25X0.8mm
交叉管 Cross tube	15X30X2.0/1.6mm	15X30X1.6/1.2mm	15X30X0.6mm	13X23X0.6mm	13X23X0.6mm
配件 Accessories	带加强套, 全套连接配件, 铝合金脚柱, 金属三角架, 防风绳, 防风球, 防风扣。 reinforcing sleeve, plastic connection, aluminum base	带加强套, 全套连接配件, 铝合金脚柱, 金属三角架, 防风绳, 防风球, 防风扣。 reinforcing sleeve, plastic connection, aluminum base	带加强套, 铝接头, 大风扣, 防风球, 防风扣, 防风球。 reinforcing sleeve, aluminum iron base	带加强套, 全套连接配件, 铝合金脚柱, 防风球, 防风扣。 reinforcing sleeve, plastic connection	带加强套, 全套连接配件, 铝合金脚柱, 防风球, 防风扣。 Allround use square tube middle axle use circular tube with mechanical spring
可选布料 Optional fabric	420D牛津布, 厚度28C, 抗水压1500mm, 克重: 280g/M ² 420D Oxford fabric, thickness: 28C, Anti hydraulic pressure: 1000mm, Gram: 285g/M ²	600*600D牛津布, 厚度32C, 抗水压1600mm, 克重: 313g/M ² 600*600D oxford fabric, thickness: 32C, Anti hydraulic pressure: 1000mm, Gram: 313g/M ²	300D*300D 长纤维, 克重: 125g/M ² , 阻燃: CPAI-84标准抗紫外线, AATCC-183 UV 50+ 水压: 800mm 300D*300D long fibre fabric, anti-flaming standard: CPAI-84, uv-resistant: AATCC-183 UV 50+, Anti hydraulic pressure: 800mm, Gram: 125g/M ²	300D*300D 带涂层, 克重: 180g/M ² , 阻燃: CPAI-84标准抗紫外线, AATCC-183 UV 50+ 水压: 800mm 300D*300D polyester, anti-flaming standard: CPAI-84, uv-resistant: AATCC-183 UV 50+, Anti hydraulic pressure: 800mm, Gram: 180g/M ²	600*600D长纤维, 克重: 220g/M ² , 阻燃: CPAI-84标准抗紫外线, AATCC-183 UV 50+ 水压: 800mm 600D*600D polyester, anti-flaming standard: CPAI-84, uv-resistant: AATCC-183 UV 50+, Anti hydraulic pressure: 800mm, Gram: 225g/M ²

1.5x1.5m 折叠帐篷 1.5x1.5m Folding Tent



尺寸 (Size)

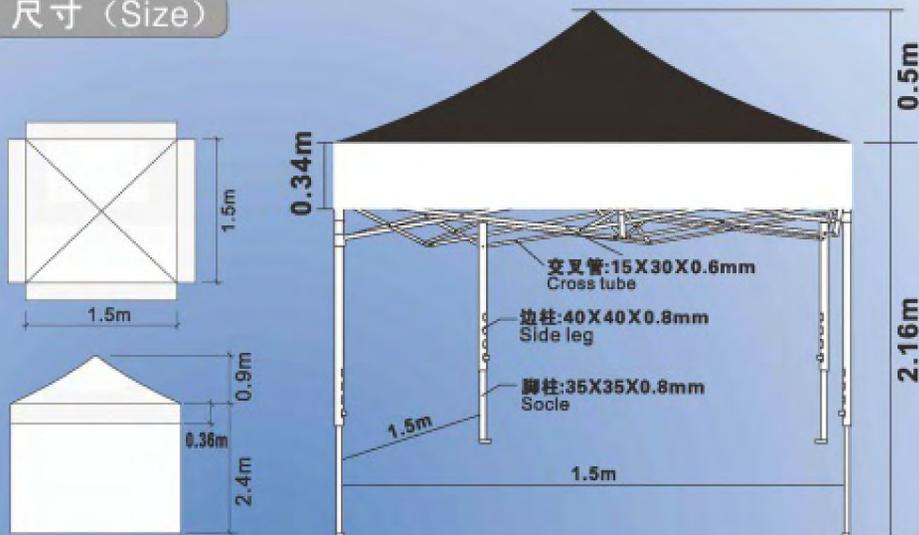

1.5X1.5m	豪华铝支架 Deluxe Aluminium	中档铝支架 Mid-range Aluminium	豪华钢支架 Deluxe Steel	中档钢支架 Mid-range Steel	普通铁支架 Ordinary Iron
边柱 Side leg	41X41X2.0mm	36X36X1.8mm	40X40X0.8mm	30X30X0.6mm	30X30X0.6mm
脚柱 Socle	36X36X1.8mm	31X31X1.7mm	35X35X0.8mm	25X25X0.6mm	25X25X0.6mm
交叉管 Cross tube	15X30X2.0/1.8mm	15X30X1.6/1.2mm	15X30X0.6mm	13X23X0.6mm	13X23X0.6mm
配件 Accessories	带加强圈, 全塑料连接管, 带底座塑料片, 基础三角架脚垫, 基础连接, 基础连接, 基础连接.	带加强圈, 全塑料连接管, 带底座塑料片, 基础三角架脚垫, 基础连接, 基础连接, 基础连接.	带加强圈, 铁球头, 大底座, 基础连接, 基础连接, 基础连接.	带加强圈, 全塑料连接管, 带底座塑料片, 基础三角架脚垫.	带加强圈, 全塑料连接管, 带底座塑料片, 基础三角架脚垫.
可选布料 Optional fabric	420D牛津布, 厚度200 防水100%, 重量: 280克/平方 420D Oxford fabric, Thickness: 200 Anti hydraulic pressure: 1000mm Gram: 280g/M ²	600*800D牛津布, 厚度 330克/平方(340mm), 重量: 313克/平方 600*800D Oxford fabric, Thickness: 320 Anti hydraulic pressure: 1000mm Gram: 313g/M ²	300D*300D 涤纶布, 重量: 1280/92 盎司 CPAI-84标准抗紫外线, AATCC-183 UV 50+ 水, 压, 800mm 300D*300D long fibre fabric, antiflaming standard, CPAI-84 ultraviolet resistant, AATCC-183 UV 50+ Anti hydraulic pressure: 800mm Gram: 1280g/M ²	390D*300D 涤纶布, 重量: 1800/92 盎司, CPAI-84 标准 抗紫外线, AATCC-183 UV 50+ 水, 压, 800mm 390D*300D polyester antiflaming standard, CPAI-84 ultraviolet resistant, AATCC-183 UV 50+ Anti hydraulic pressure: 800mm Gram: 1800g/M ²	600D*800D 涤纶布, 重量: 2280/92 盎司, CPAI-84标准 抗紫外线, AATCC-183 UV 50+ 水, 压, 800mm 600D*800D polyester, antiflaming standard, CPAI-84 ultraviolet resistant, AATCC-183 UV 50+ Anti hydraulic pressure: 800mm Gram: 2280g/M ²

4x4m 折叠帐篷 4x4m Folding Tent

折叠帐篷结构示意图 Folding Tent Structure Diagram



铝支架 Aluminum frame



钢支架 Steel frame



香蕉伞 Hanging Umbrella

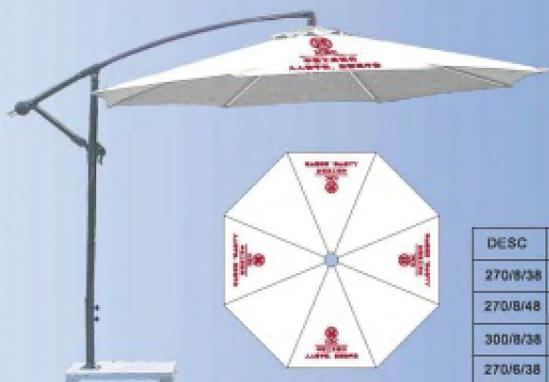

DESC	SIZE IN METERS(FEET)	POLE(MM)	RIIB(PCGS)	SHAPE
270/8/38	2.7M (9')	Ø38	6	
270/8/48	2.7M (9')	Ø48	8	
300/8/38	3.0M (10')	Ø38	8	
270/6/38	2.7M (9')	Ø38	6	



香蕉伞 Hanging Umbrella



单边吊伞 Unilateral Hanging Umbrella



吊伞基本规格

规格 size	布料 fabric	材质 material	打开直径 diameter(opened)	立柱 stand column	管厚度 tube thickness	形状 SHAPE
3X3M	210克涤纶布 280g polyester	铝合金 aluminum alloy	3M	2100*42*69MM	2.5MM	
2.5X2.5M	280克涤纶布 280g polyester	铝合金 aluminum alloy	2.5M	2100*42*69MM	2.5MM	
2.1X2.1M	180克涤纶布 280g polyester	铝合金 aluminum alloy	2.1M	2100*42*69MM	2.5MM	
3M	280克涤纶布 280g polyester	铝合金 aluminum alloy	3M	2100*42*69MM	2.5MM	
2.5M	280克涤纶布 280g polyester	铝合金 aluminum alloy	2.5M	2100*42*69MM	2.5MM	

园林伞 Garden Umbrella



园林伞 Garden Umbrella



DESC	SIZE IN METERS(FEET)	POLE(MM)	RIB(PCS)	SHAPE
250/8/38	2.5M (8')	Ø38	8	
270/8/38	2.7M (9')	Ø38	8	
300/8/38	3.0M (10')	Ø38	8	
270/6/38	2.7M (9')	Ø38	6	
250*250/8/48	2.5*2.5M (8'*8')	Ø48	8	
300*300/8/48	3.0*3.0M (9'*9')	Ø48	8	

40寸太阳伞 40 Inch Sun Umbrella



太阳伞基本规格

规格 Size	布料 Fabric	伞架型 Ribs	打开直径 Diameter (open)	下管高度 down tube height	上管高度 Up tube height	下管直径 down tube dia	上管直径 Up tube dia
40XBK	210D牛津布 oxford fabric	3. 8单骨 single ribs	1.88M	1.15M	1.15M	32MM	20MM
40XBK	210D牛津布 oxford fabric	4. 8单骨 single ribs	1.88M	1.15M	1.15M	32MM	20MM
40XBK	210D牛津布 oxford fabric	4. 8单骨 single ribs	1.88M	1.15M	1.15M	32MM	20MM
40XBK	210D牛津布 oxford fabric	4. 8单骨 single ribs	1.88M	1.15M	1.15M	32MM	20MM



48寸太阳伞

48 Inch Sun Umbrella

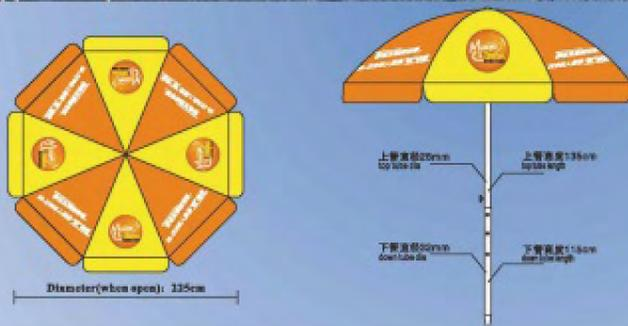

太阳伞基本图种 specification

规格 Size	布料 Fabric	阳伞罩 Ribs	打开直径 Diameter (open)	下管高度 Base hole height	上管高度 Top hole height	下管直径 Bottom hole dia	上管直径 Top hole dia
48X8K	210磅牛津布 210lb Oxford fabric	4.5 直骨 4.5 straight ribs	2.25M	1.15M	1.35M	32MM	28MM
48X8K	210磅牛津布 210lb Oxford fabric	4.0 直骨 4.0 straight ribs	2.25M	1.15M	1.35M	32MM	28MM
48X8K	210磅牛津布 210lb Oxford fabric	4.0 防风 4.0 windproof	2.25M	1.15M	1.35M	32MM	28MM



52寸太阳伞

52 Inch Sun Umbrella



尺寸 (Size)

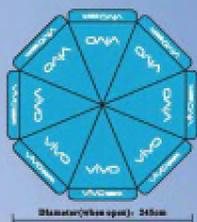

太阳伞基本规格

规格 Size	伞柄 Fabric	架类型 Dish	打开直径 Outside (open)	下管高度 Outside height	上管高度 Inside height	下管直径 Down tube dia.	上管直径 Up tube dia.
62X8K	21磅牛津布 600D fabric	4.5单骨 single rib	2.45M	1.15M	1.47M	32MM	29MM
52X8K	21磅牛津布 600D fabric	4.0双骨 double rib	2.45M	1.15M	1.47M	32MM	29MM
52X8K	21磅牛津布 600D fabric	4.0防风 windproof	2.45M	1.15M	1.47M	32MM	29MM



52寸太阳伞

52 Inch Sun Umbrella



尺寸 (Size)

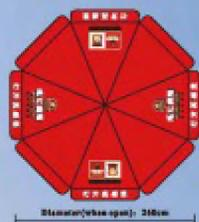

太阳伞基本规格

规格 Size	布料 Fabric	架类型 Ribs	打开直径 (Shower open)	下管高度 (Down top length)	上管高度 (Up length)	下管直径 (Down dia)	上管直径 (Up dia)
60X8K	210加密牛津布 coated fabric	4.5龙骨 4.5 ribs	2.60M	1.10M	1.47M	32MM	28MM
60X8K	210加密牛津布 coated fabric	4.0龙骨 4.0 ribs	2.60M	1.15M	1.47M	32MM	28MM
60X8K	210加密牛津布 coated fabric	4.5防风 4.5 ribs	2.60M	1.15M	1.47M	32MM	28MM



彩虹门

Inflatable Rainbow Arch

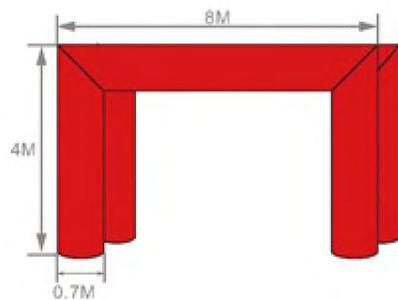
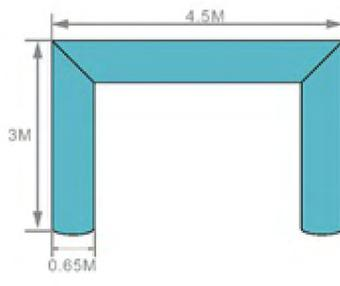
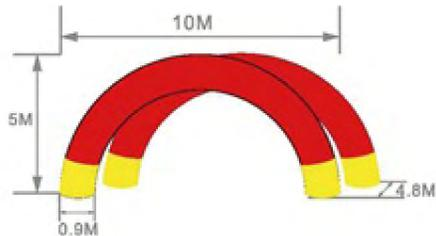
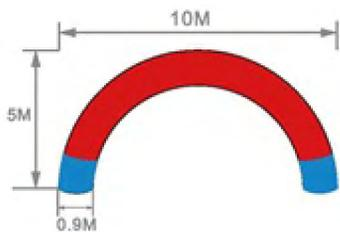

拱门 arched door

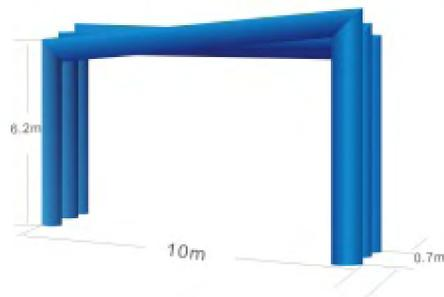
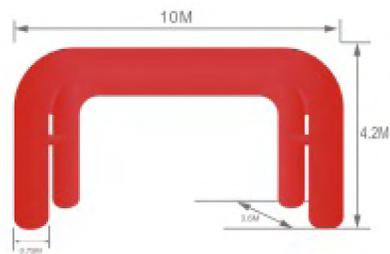

欢迎来图定制
Send us your design for
Customized Sample!!!



晴雨伞 Umbrella



SPT01



尺寸:三折手开圆形伞, 21寸*8骨
张伞直径:93CM
中棒:电镀铁中棒
伞骨:电镀伞骨, 黑色纤维玻璃纤维
伞头:小弯头包PU仿皮
伞布:190T印花Pongee布
布套:本布袖口布套



size: triple folding umbrella (manual), 21 inch* 8 ribs
Diameter(opened): 93cm
handle: rubber sharp bend with PU
Fabric: 190T pongee
Rib: aluminum, black colour glass fibre



SPT04



尺寸:三折自动开收伞 23寸*10骨
张伞直径:100CM
中棒:铁中棒
伞骨:铁骨, 白色纤维玻璃纤维
伞头:黑色橡胶玻璃伞头
伞布:190T Pongee布 过锡膜
布套:手提式布套



size: triple folding umbrella (automatic), 23 inch* 10 ribs
Diameter(opened): 105cm
handle: rubber
Fabric: 190T pongee
Rib: iron, white colour aluminum fibre



SPT02



尺寸:三折手开圆形伞, 21寸*8骨
张伞直径:93CM
中棒:镀锌铝中棒
伞骨:镀锌铝骨, 白色纤维玻璃纤维
伞头:塑胶黑色伞头
伞布:190T Pongee布 包边
布套:本布袖口布套



size: triple folding umbrella (manual), 21 inch* 8 ribs
Diameter(opened): 93cm
handle: plastic
Fabric: 190T pongee
Rib: aluminum, white colour fibre



SPT05



尺寸:三折自动开收伞 23寸*8骨
张伞直径:100CM
中棒:铁中棒
伞骨:铁骨, 中玻璃纤维纤维白色玻璃纤维
伞头:黑橡胶玻璃伞头
伞布:190T纱丁布 过锡印
布套:本布袖口布套



size: triple folding umbrella (automatic), 23 inch* 8 ribs
Diameter(opened): 103cm
handle: rubber
Fabric: 190T satin
Rib: aluminum, white colour glass fibre



SPT03



尺寸:三折自动开收伞 21寸*8骨
张伞直径:90CM
中棒:铁中棒
伞骨:电镀铁骨, 白色纤维玻璃纤维
伞头:黑色橡胶玻璃伞头, 黑色尼龙伞头布
伞布:190T Pongee布 易特印
布套:本布袖口布套



size: triple folding umbrella (automatic), 21 inch* 8 ribs
Diameter(opened): 95cm
handle: rubber
Fabric: 190T pongee
Rib: iron, white colour aluminum fibre



SPT06



尺寸:三折自动开收伞 21寸*8骨
张伞直径:95CM
中棒:黑色铝中棒
伞骨:铁骨, 黑色纤维玻璃纤维
伞头:黑色橡胶玻璃伞头 可翻帽筒
伞布:190T Pongee布
布套:本布袖口布套



size: triple folding umbrella (automatic), 21 inch* 8 ribs
Diameter(opened): 95cm
handle: rubber
Fabric: 190T pongee
Rib: iron, black colour fibre





SPT07



尺寸:直骨自动开雨伞, 27寸*8骨
张伞直径:123CM
中棒:14MM黑色铁骨
伞骨:玻璃纤维伞骨
伞头:黑色橡胶伞头带按钮
伞布:190T 碰击布
布套:无伞套



size:pole umbrella(automatic),27inch*8ribs
Diameter(opened):123cm
handle:rubber
umbrella stand:14mm iron
Fabric:190T pongee
Rib:black colour/glass fibre



SPT08



尺寸:直骨自动开雨伞, 30寸*8骨
张伞直径:135CM
中棒:14MM玻璃纤维中棒
伞骨:全纤维伞骨
伞头:EVA直柄伞头,内嵌式按钮
伞布:190T碰击布
布套:无伞套



size:pole umbrella (automatic), 30 inch* 8 ribs
Diameter(opened):135cm
handle:rubber
umbrella stand:14mm glass fibre
Fabric:190T pongee
Rib:black colour fibre



SPT09



尺寸:直骨自动开雨伞, 27寸*8K(18骨)
张伞直径:123CM
中棒:14MM黑色铁骨
伞骨:双骨, 电鍍黑色铁骨
伞头:塑胶三指状, 喷黑色橡胶漆
伞布:190T碰击布
布套:无伞套



size:pole umbrella (automatic), 27 inch* 8 ribs
Diameter(opened):123cm
handle:plastic
umbrella stand:14mm iron
Fabric:190T pongee
Rib:iron, black colour double ribs



SPT10



尺寸:直骨自动开双层雨伞, 23寸*8骨
张伞直径:105CM
中棒:14MM木中棒
伞骨:电鍍黑色伞骨
伞头:木骨头
伞布:190T碰击布双层布
布套:无伞套



size:pole umbrella (automatic), 23 inch* 8 ribs
Diameter(opened):105cm
handle:woodiness
umbrella stand:14mm woodiness
Fabric:190T double pongee
Rib:aluminum, black colour



SPT11



尺寸:直骨自动开雨伞, 23寸*8骨
张伞直径:105CM
中棒:10MM黑色铁骨
伞骨:电鍍黑色铁骨
伞头:黑色橡胶伞柄
伞布:190T碰击布
布套:无布套



size:pole umbrella (automatic), 23 inch* 8 ribs
Diameter(opened):105cm
handle:rubber
umbrella stand:10mm iron
Fabric:190T pongee
Rib:iron, black colour



SPT12



尺寸:直骨自动开雨伞, 23寸*8骨
张伞直径:105CM
中棒:14MM纯木色木中棒
伞骨:电鍍黑色伞骨
伞头:纯木色木骨头
伞布:190T碰击布
布套:无布套



size:pole umbrella (automatic), 23 inch* 8 ribs
Diameter(opened):105cm
handle:woodiness
umbrella stand:14mm woodiness
Fabric:190T pongee
Rib:aluminum, black colour



晴雨伞 Umbrella



SPT13



尺寸:直骨自动高尔夫双顶伞, 30寸*8骨
张伞直径:135CM
中轴:14MM玻璃纤维中轴
伞骨:全玻璃纤维伞骨
伞头:EVA直柄伞头, 内嵌式按钮
伞布:190T蓬布
布套:背带式布套



size: golf umbrella (automatic), 30 inch* 8 ribs
Diameter(opened): 135cm
handle: EVA
umbrella stand: 14mm glass fibre
Fabric: 190T pongee
Rib: black colour glass fibre



SPT14



尺寸:直骨自动高尔夫双顶方伞, 30寸*8骨
张伞直径:135CM
中轴:14MM玻璃纤维中轴
伞骨:全玻璃纤维伞骨加红色按钮
伞头:黑色橡胶伞头底部可贴铭牌
伞布:190T蓬布
布套:背带式布套



size: golf umbrella (automatic), 30 inch* 8 ribs
Diameter(opened): 135cm
handle: rubber
umbrella stand: 14mm glass fibre
Fabric: 190T pongee
Rib: black colour glass fibre



SPT15



尺寸:直骨自动高尔夫伞, 30寸*8骨
张伞直径:135CM
中轴:14MM玻璃纤维中轴
伞骨:全玻璃纤维伞骨
伞头:EVA直柄伞头, 内嵌式按钮
伞布:190T蓬布
布套:无布套



size: golf umbrella (automatic), 30 inch* 8 ribs
Diameter(opened): 135cm
handle: EVA
umbrella stand: 14mm glass fibre
Fabric: 190T pongee
Rib: black colour glass fibre



SPT16



尺寸:三折自动开伞, 21寸*8骨
张伞直径:95CM
中轴:铁中轴
伞骨:铁伞骨, 白色玻璃纤维尾骨
伞头:三折按钮胶柄黑色橡胶伞头, 黑色尼龙伞头带
伞布:190T蓬布
布套:本布轴口布套



size: triple folding umbrella (automatic), 21 inch* 8 ribs
Diameter(opened): 95cm
handle: plastic
umbrella stand: iron
Fabric: 190T pongee
Rib: iron



SPT17



尺寸:精品三折手开圆伞, 21寸*8骨
张伞直径:95CM
中轴:铁中轴
伞骨:电压铁骨
伞头:黑色圆顶伞头
伞布:170T涤纶篷布
布套:本布轴口布套



size: triple folding umbrella (manual), 21 inch* 8 ribs
Diameter(opened): 95cm
handle: plastic
umbrella stand: iron
Fabric: 170T dacon
Rib: iron



SPT18



尺寸:直骨自动开伞伞, 23寸*16骨
张伞直径:105CM
中轴:12MM黑色尼龙轴中轴
伞骨:用普通黑色铁骨, 玻璃纤维伞骨
伞头:直骨手柄, 外圈包PU胶柄
伞布:190T黑色涤纶布, 彩虹色切片拼布
布套:背带式布套



size: pole rainbow umbrella (automatic), 23 inch* 16 ribs
Diameter(opened): 105cm
handle: plastic with PU
umbrella stand: 12mm iron
Fabric: 190T pongee
Rib: iron, black colour



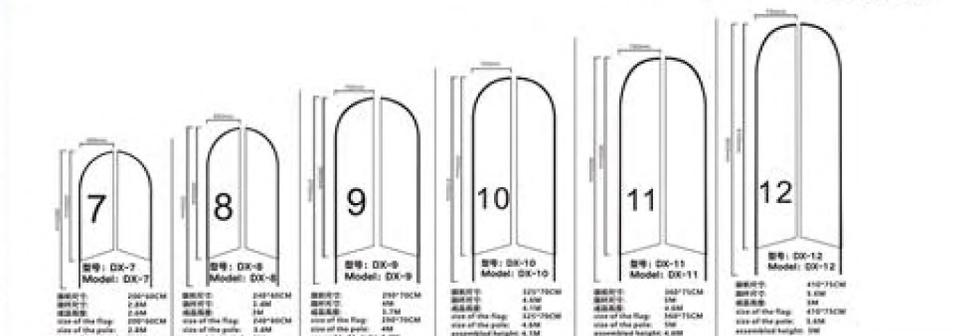
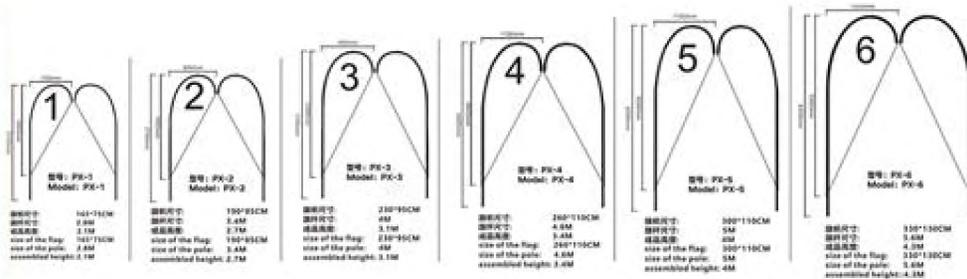

桌布 Table Cover

Our spandex table cover must be your best choice as a cocktail event, party tablecloths, wedding tablecloths, baby shower, anniversary, birthday party. They can also be used in vendors, buffet table cloths, banquet table covers, trade show table cloths, hotel receptions, buffet, the dessert, etc.
It takes only a few seconds to make your table look professional or interesting.



特殊帐篷 Special Tent



可选配件 Optional Accessory

			
A型蓝色水座 Type A blue water base	B型水座 Type B water base	C型蓝色水座 Type C blue water base	D型水座 Type D blue water base
			
A型红色水座 Type A red water base	A型绿色水座 Type A green water base	C型绿色水座 Type C green water base	C型红色水座 Type C red water base
			
20KG铁底座 20KG iron base	十字型铁座 Cross iron base	帐篷水座 Tent water base	20KG大理石底座 20KG marble base
			
3X3M普通帐篷 3X3M normal tent bag	3X3M加强帐篷 3X3M enhance tent bag	3X3M帐篷 3X3M tent bag	3X6M帐篷 3X6M tent bag
			
J-4-4	B-4-4	J-4	A-3-6水槽 water channel

			
12KG-A	12KG-B	15KG-A	15KG-B
			
15KG-C	16KG-A	22KG-A	22KG-B
			
22KG-C	22KG-D	25KG-A	25KG-B
			
32KG-A	32KG-B	35KG-A	35KG-B
			
30KGX4	包装 packaging	底部 bottom	配件 accessories

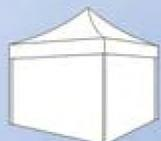

全围
All Round



半围
Half Round

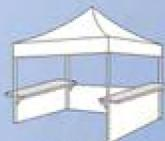

活动台板
The Movable Bedplate



装饰立柱
Decorative Column



带卷门
Roll Door



带拉链门
Zipper Gate



教堂窗
Church Window



纱窗
Screen Window



透明窗
Transparent Window



排水槽
Drain Tank

