



- ✦ Party Tent
- ✦ Pagoda Tent
- ✦ Gazebo Tent
- ✦ Star Tent
- ✦ Tension Tent
- ✦ Tent Accessories





Party • Wedding • Luxury Life



COMPANY PROFILE

Tent Co., Ltd.

is an enterprise integrating production, processing and sales. The company introduces advanced equipment and uses high-quality materials to produce various wedding tents, storage tents, exhibition tents, simple hexagonal tents, Advertising tents, advertising umbrellas, advertising gift umbrellas, children umbrellas, rain umbrellas, garden umbrellas, banana umbrellas, beach umbrellas, parasols, Inflatable arch, and other inflatable advertising products series, and continue to develop new related products.

Tent has a strong technical force, has experienced professionals in various production links, such as senior computer designers, production technicians, manufacturing professionals and a rigorous management system. It has always adhered to the tenet of "reputation first, quality assurance". With excellent quality, we promise to provide customers with long-term stable quality products, which is also the way to survive in the sea of commerce. Tent.com sincerely welcomes elites from all walks of life to visit



目录 contents

- 锥顶篷
Pagoda Tent 01/06
- 吊顶篷
Gazebo Tent 07/08
- 张拉篷
Tension Tent 09/12
- 飞形篷
Star Tent 13/14
- 标准篷房
Party Tent 15/20
- 多边形篷
Polygon Tent 21/22
- 组合篷房
Combination Tent 23/24
- 拱形篷房
Dome Tent 25/26
- 桃形篷房
Curved Tent 27/28





小型锥顶篷 Small Pagoda Tent



尺寸 (Size)

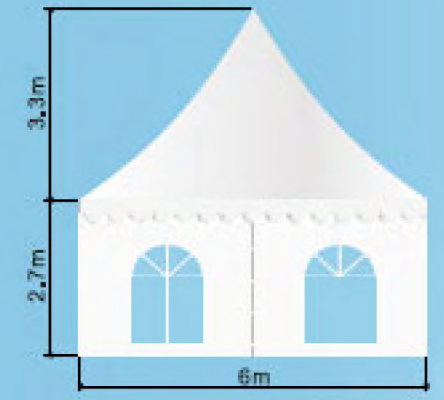
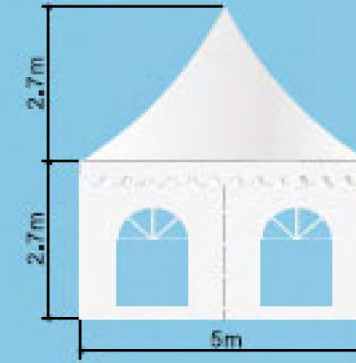
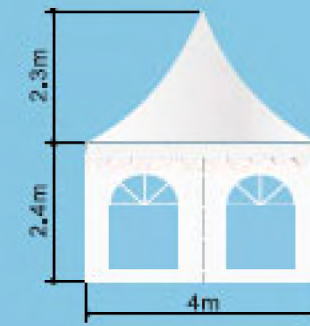
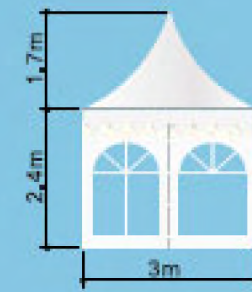

架构 (Frame)



主要管截面 Main profile

立柱 leg 横梁 eave beam	斜撑杆 bevel beam	中心撑杆 center pole	围布压杆 sidewall rail downside rail



- 支架材料
+ 高强度铝合金型材
表面氧化处理
- 连接方式
+ 内插对接方式
连接件采用钢件
表面镀锌处理
- 篷布材质
+ 双面涂PVC合成
纤维布, 防水、
阻燃、抗紫外线,
抗老化

- Frame material
+ high quality aluminum
alloy, oxidation treatment
- Connection
+ inset joint, parts adopt
steel with galvanized
- Cover material
+ polyester with double side
PVC coated, water proof,
flameretardant, uvioresistant,
antiaging



大型锥顶篷 Big Pagoda Tent



尺寸 (Size)

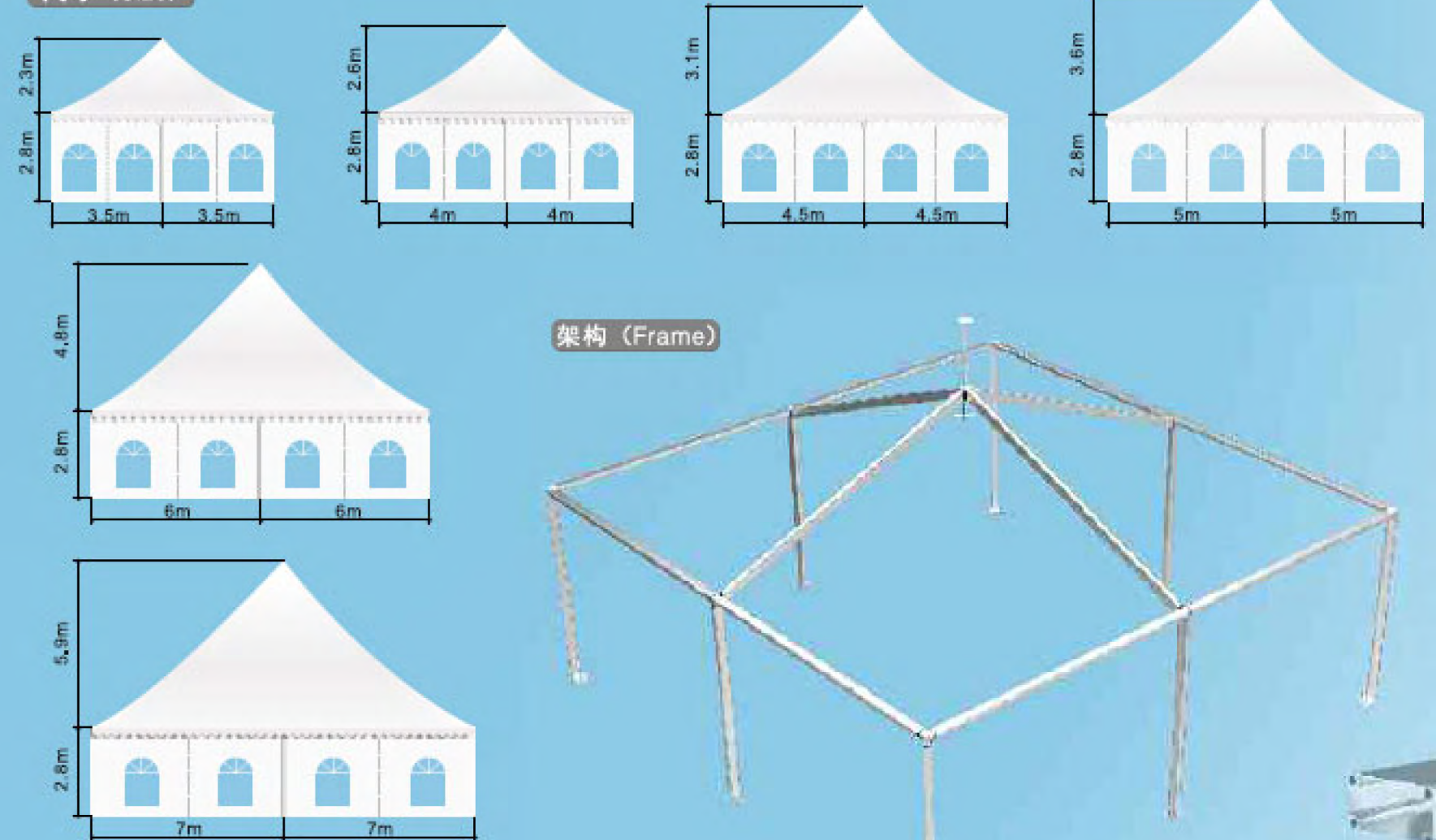

架构 (Frame)

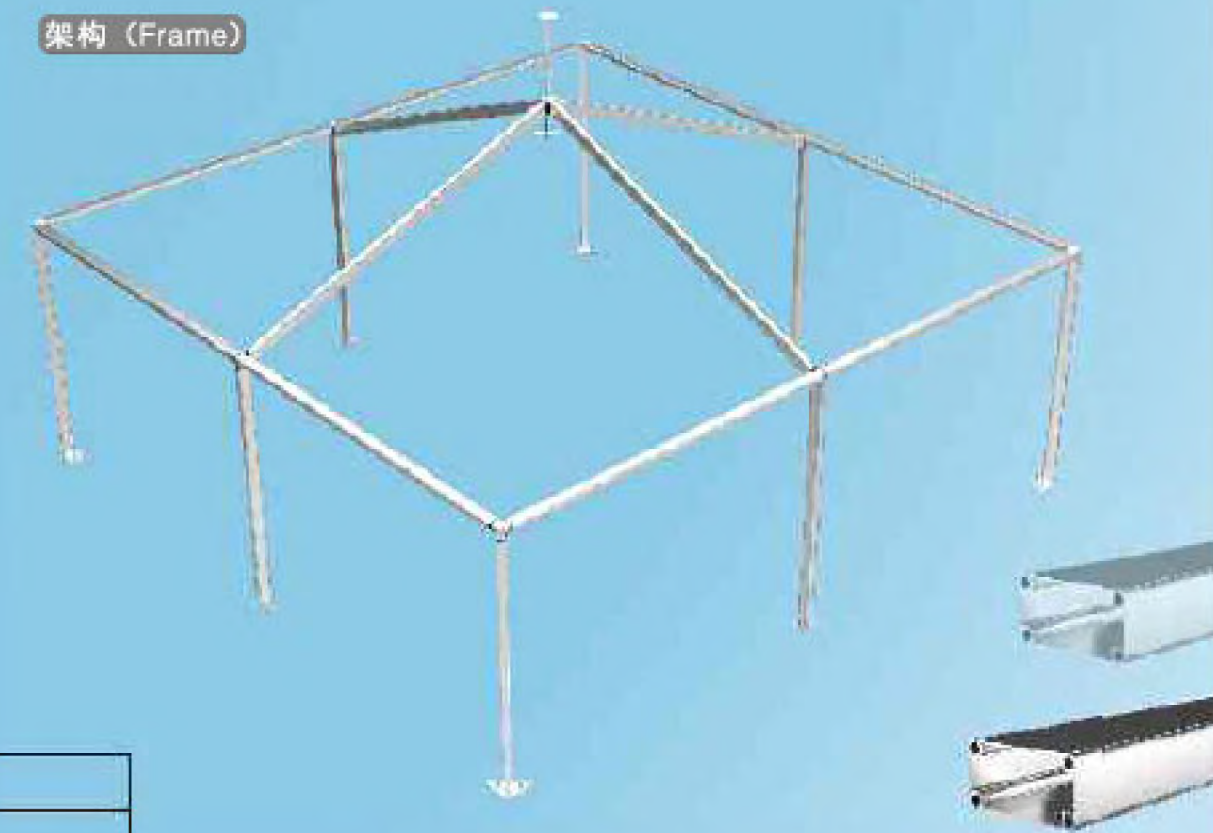

主要管截面 Main profile

<p>立柱 leg 斜撑杆 bevel beam 横梁 eave beam</p>	<p>立柱 leg 斜撑杆 bevel beam 横梁 eave beam</p>	<p>中心撑杆 center pole</p>	<p>圆管压杆 sidewall rail</p>
---	---	-----------------------------	-------------------------------

- 支架材料
+ 高强度铝合金型材
表面氧化处理
- 连接方式
+ 内插对接方式
连接件采用钢件
表面镀锌处理
- 篷布材质
+ 双面涂PVC合成
纤维布, 防水、
阻燃、抗紫外线、
抗老化
- Frame material
+ high quality aluminum
alloy, oxidation treatment
- Connection
+ inset joint, parts adopt
steel with galvanized
- Cover material
+ polyester with double side
PVC coated, water proof,
flameretardant, uvioresistant,
antiaging





长方形锥顶篷

Rectangular Pagoda Tent



- 支架材料
 - + 高强度铝合金型材表面氧化处理
- 连接方式
 - + 内插对接方式连接件采用钢件表面镀锌处理
- 篷布材质
 - + 双面涂PVC合成纤维布，防水、阻燃、抗紫外线，抗老化

六边形锥顶篷

Hexagon Pagoda Tent



- Frame material
 - + high quality aluminum alloy, oxidation treatment
- Connection
 - + inset joint, parts adopt steel with galvanized
- Cover material
 - + polyester with double side PVC coated, water proof, flameretardant, uvioresistant, antiaging

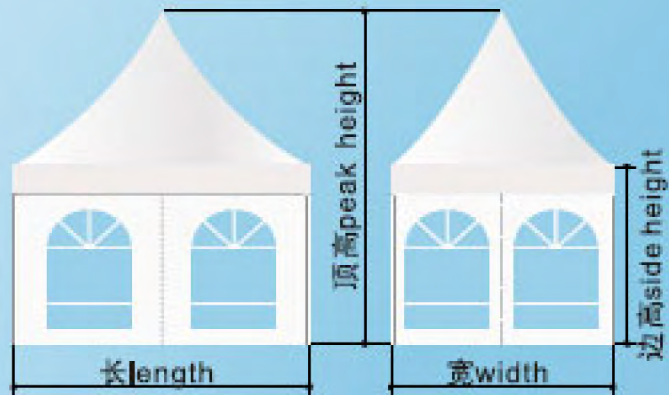

规格(宽X长) SPEC (width x length)	边高 SIDE HEIGHT	顶高 PEAK HEIGHT
3X4m	2.4m	4.5m
3X6m	2.4m	4.9m
4X5m	2.4m	4.9m
5X6m	2.4m	5.4m

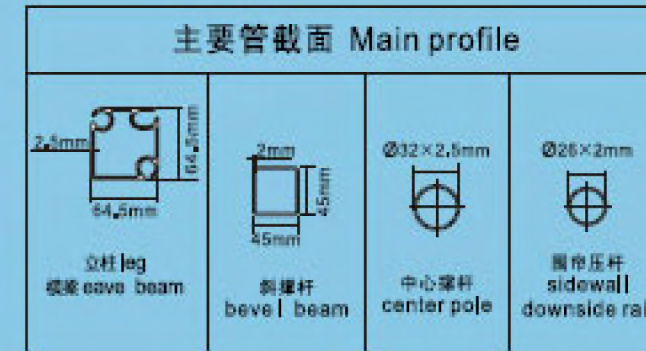

规格SPEC		边高 SIDE HEIGHT	顶高 PEAK HEIGHT
边长 SIDE LENGTH	对角线长 DIAGONAL LENGTH		
3m	6m	2.7m	5.1m
4m	8m	2.7m	5.9m
5m	10m	2.7m	6.7m
6m	12m	2.7m	7.5m





吊顶篷 Gazebo Tent



尺寸 (Size)

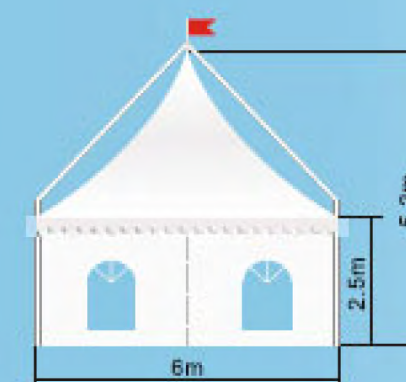
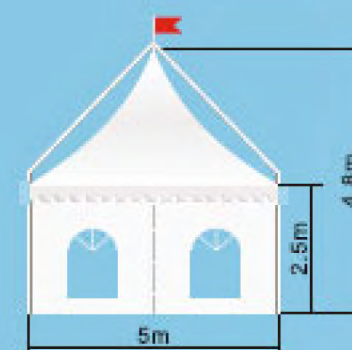
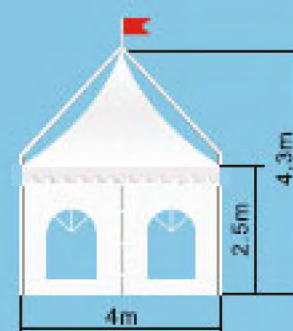
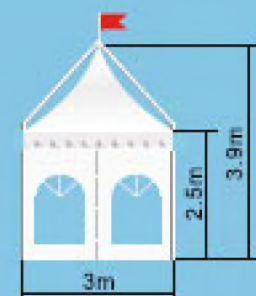

架构 (Frame)

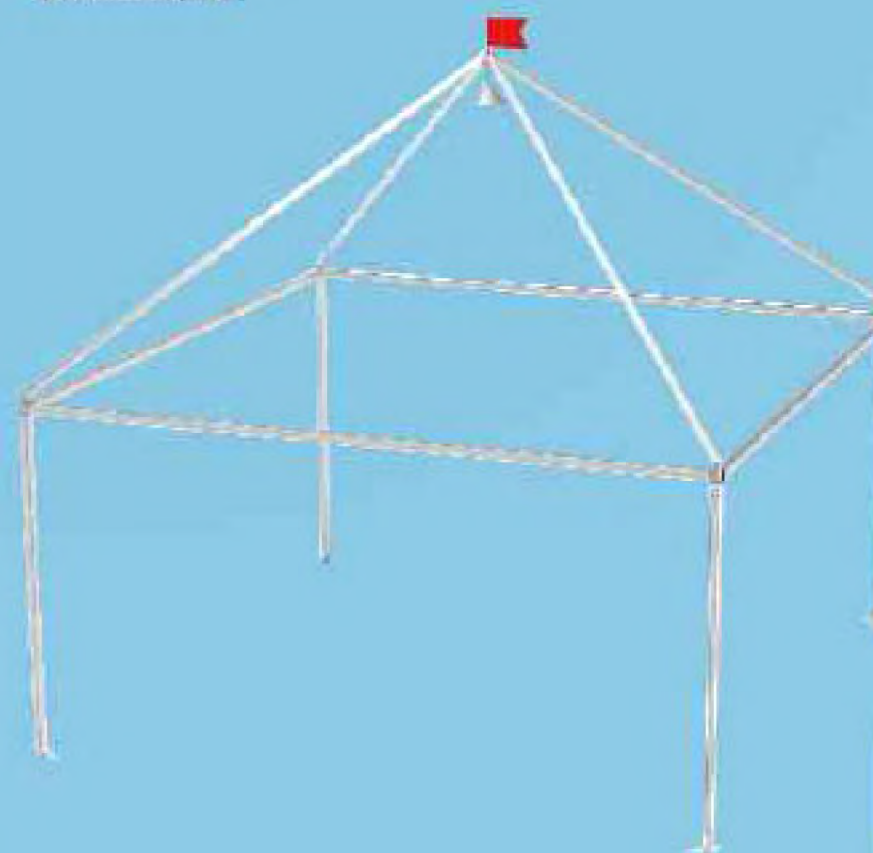

主要管截面 Main profile

 立柱 leg 横梁 cave beam	 外部斜撑杆 bevel beam	 侧帘压杆 sidewall downside rail
----------------------------	-------------------------	---------------------------------------

- 支架材料
+ 高强度铝合金型材
表面氧化处理
- 连接方式
+ 内插对接方式
连接件采用钢件
表面镀锌处理
- 篷布材质
+ 双面涂PVC合成
纤维布, 防水、
阻燃、抗紫外线,
抗老化
- Frame material
+ high quality aluminum
alloy, oxidation treatment
- Connection
+ inset joint, parts adopt
steel with galvanized
- Cover material
+ polyester with double side
PVC coated, water proof,
flameretardant, uvioresistant,
antiaging





单顶张拉篷 Single Top Tension Tent

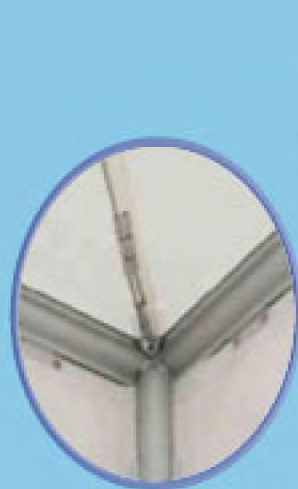

尺寸 (Size)

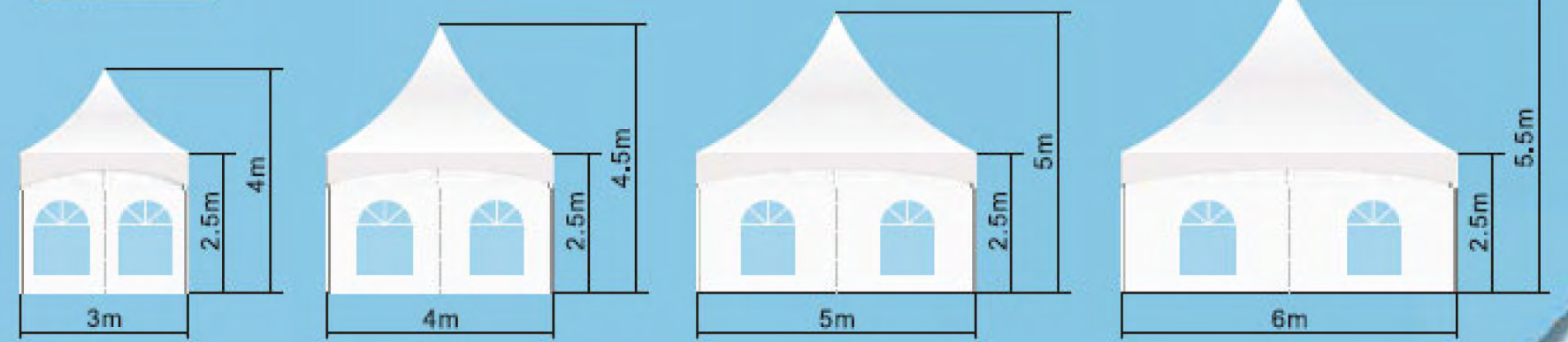

架构 (Frame)

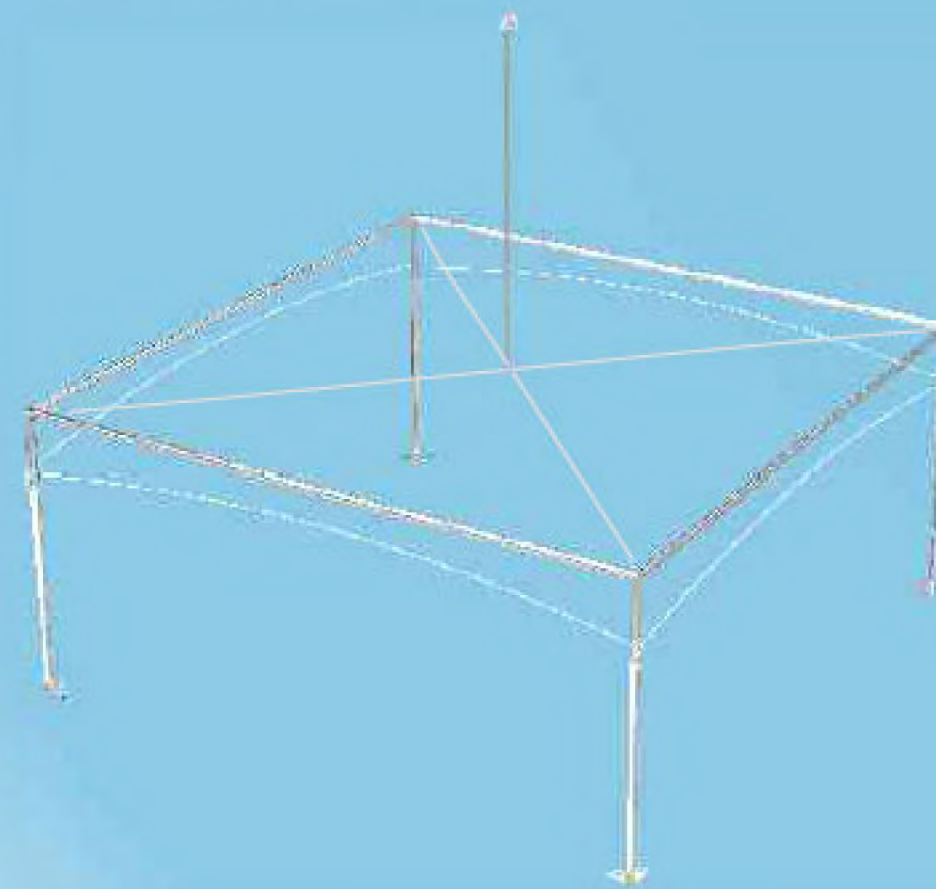

主要管截面 Main profile

$\varnothing 62 \times 2.5 \text{mm}$ 立柱 leg 横梁 eave beam	$\varnothing 37 \times 2.5 \text{mm}$ 中心撑杆 center pole	$\varnothing 26 \times 2 \text{mm}$ 侧管压杆 sidewall downside rail
---	--	--



- 支架材料
+ 高强度铝合金型材
表面氧化处理
- 连接方式
+ 内插对接方式
连接件采用钢件
表面镀锌处理
- 篷布材质
+ 双面涂PVC合成
纤维布, 防水、
阻燃、抗紫外线、
抗老化
- Frame material
+ high quality aluminum
alloy, oxidation treatment
- Connection
+ inset joint, parts adopt
steel with galvanized
- Cover material
+ polyester with double side
PVC coated, water proof,
flameretardant, uvioresistant,
antiaging



双顶张拉篷 Double Top Tension Tent



尺寸 (Size)

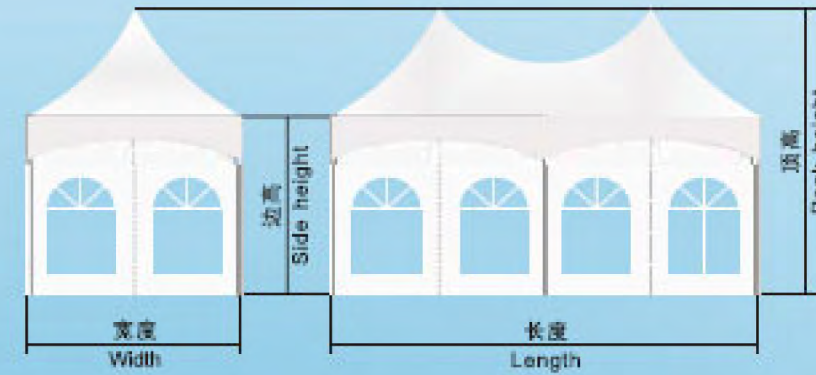

规格 Specification	宽度 Width	长度 Length	边高 Side height	顶高 Peak height
3mx6m	3m	6m	2.5m	4m
4mx8m	4m	8m	2.5m	4.5m
5mx10m	5m	10m	2.5m	5m
6mx9m	6m	9m	2.5m	5.5m
6mx12m	6m	12m	2.5m	5.5m

架构 (Frame)

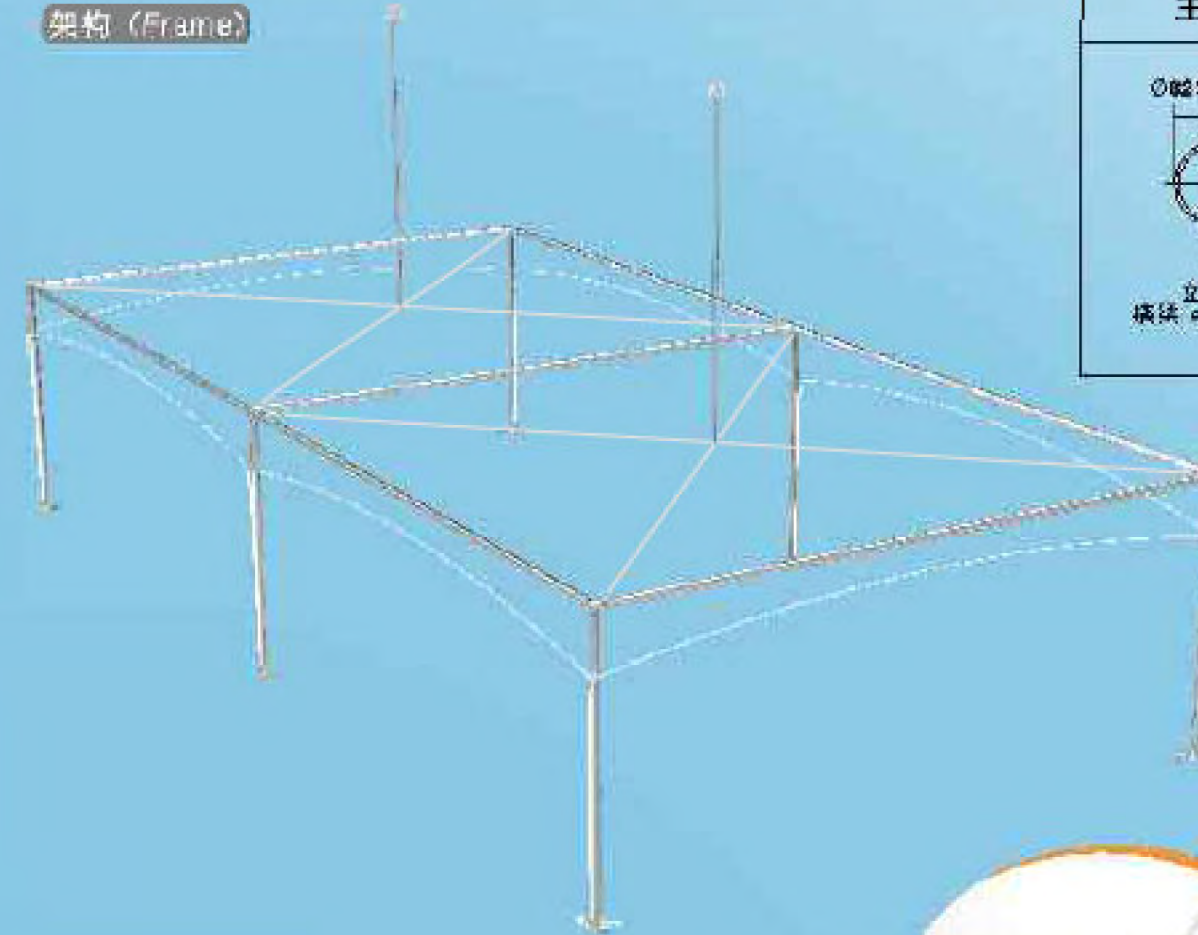

主要管截面 Main profile

Ø42×2.5mm



立柱 leg
横梁 gable beam

Ø37×2.5mm



中心撑杆
center pole

Ø26×2mm



围帘压杆
sidewall
downside rail

- 支架材料
+ 高强度铝合金型材
表面氧化处理
- 连接方式
+ 内插对接方式
连接件采用钢件
表面镀锌处理
- 篷布材质
+ 双面涂PVC合成
纤维布, 防水、
阻燃、抗紫外线,
抗老化

- Frame material
+ high quality aluminum
alloy, oxidation treatment
- Connection
+ inset joint, parts adopt
steel with galvanized
- Cover material
+ polyester with double side
PVC coated, water proof,
flameretardant, uvioresistant,
antiaging

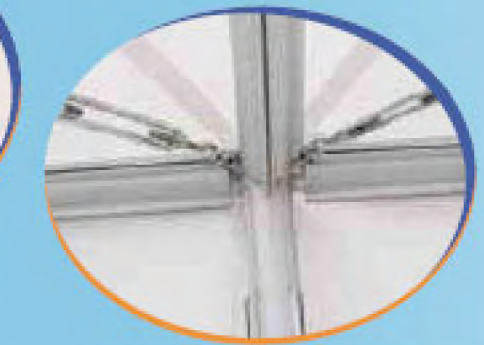



飞形篷 Star Tent

单顶 (Single top)



双顶 (Double top)



- 连接方式
+ 内插式对接方式, 配件采用钢件表面镀锌处理
- 支架材料
+ 高强度铝合金型材, 表面氧化处理
- 篷布材质
+ 双面涂PVC合成纤维布, 防水阻燃, 防紫外线, 抗老化

- Connection
+ inset joint, parts adopt steel with galvanized
- Pole material
+ high quality aluminum alloy pole, oxidation treatment
- Cover material
+ polyester with double side PVC coated, water proof, flameretardant, uvioresistant, antiaging

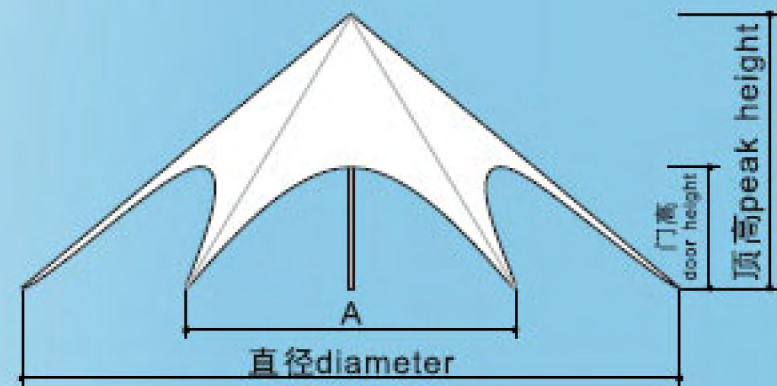

直径规格 DIAMETER SPEC	门高 DOOR HEIGHT	顶高 PEAK HEIGHT	A
∅8m	2.2m	5m	4m
∅10m	2.2m	5m	5m
∅12m	2.2m	5m	6m
∅14m	2.2m	6m	7m
∅16m	2.2m	6m	8m

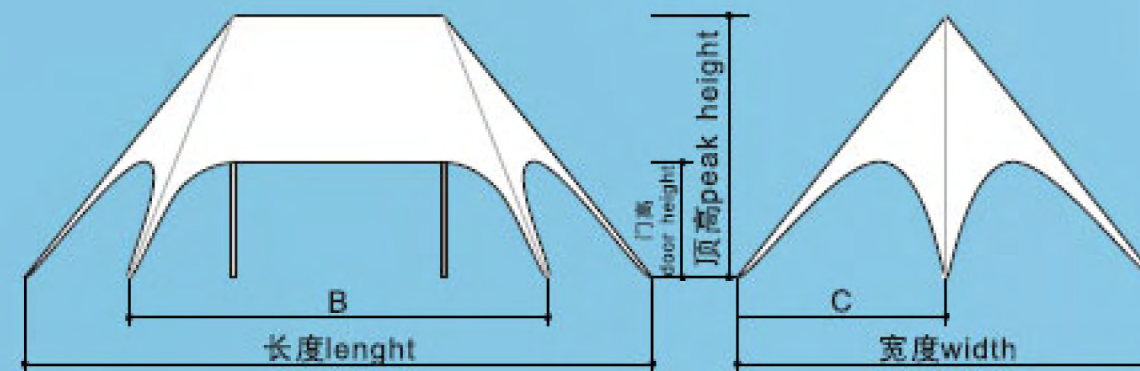
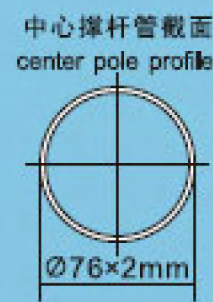

直径规格 DIAMETER SPEC	门高 DOOR HEIGHT	顶高 PEAK HEIGHT	B	C	顶间距 PEAK DISTANCE
∅8X12m	2.2m	5m	8m	4m	4m
∅10X14m	2.2m	5m	9m	5m	4m
∅12X17m	2.2m	5m	11m	6m	5m
∅14X19m	2.2m	6m	12m	7m	5m
∅16X21m	2.2m	6m	13m	8m	5m



小型篷房 Small Size Party Tent

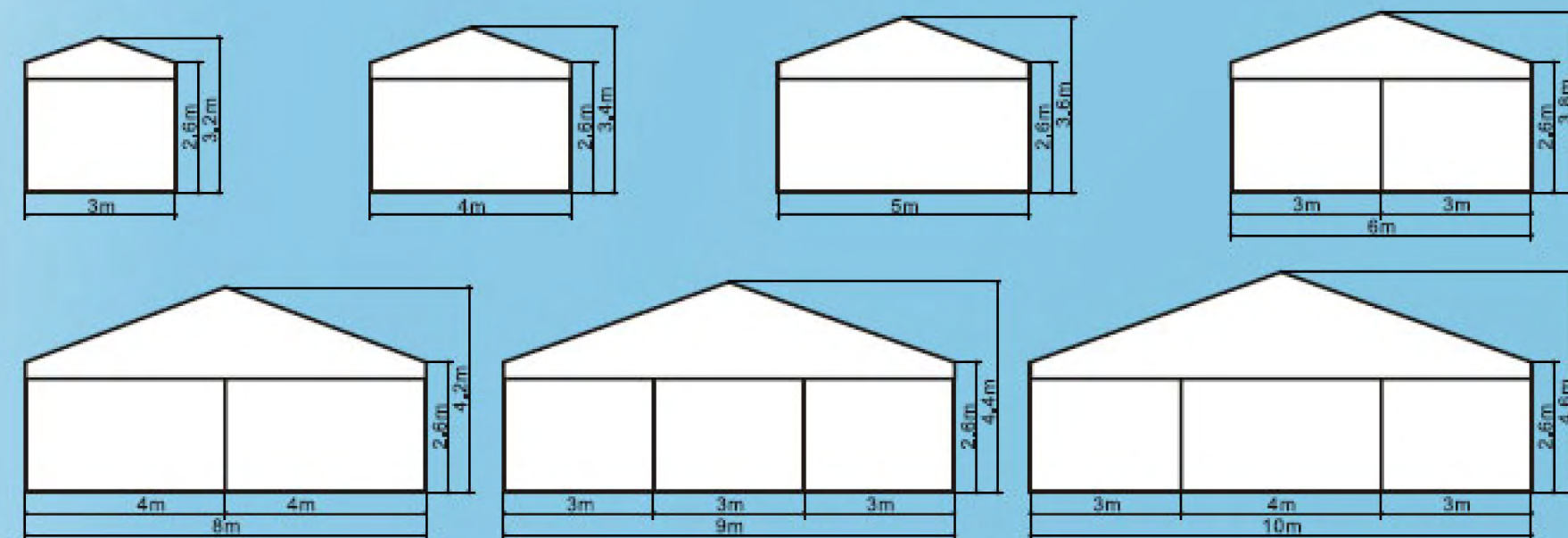
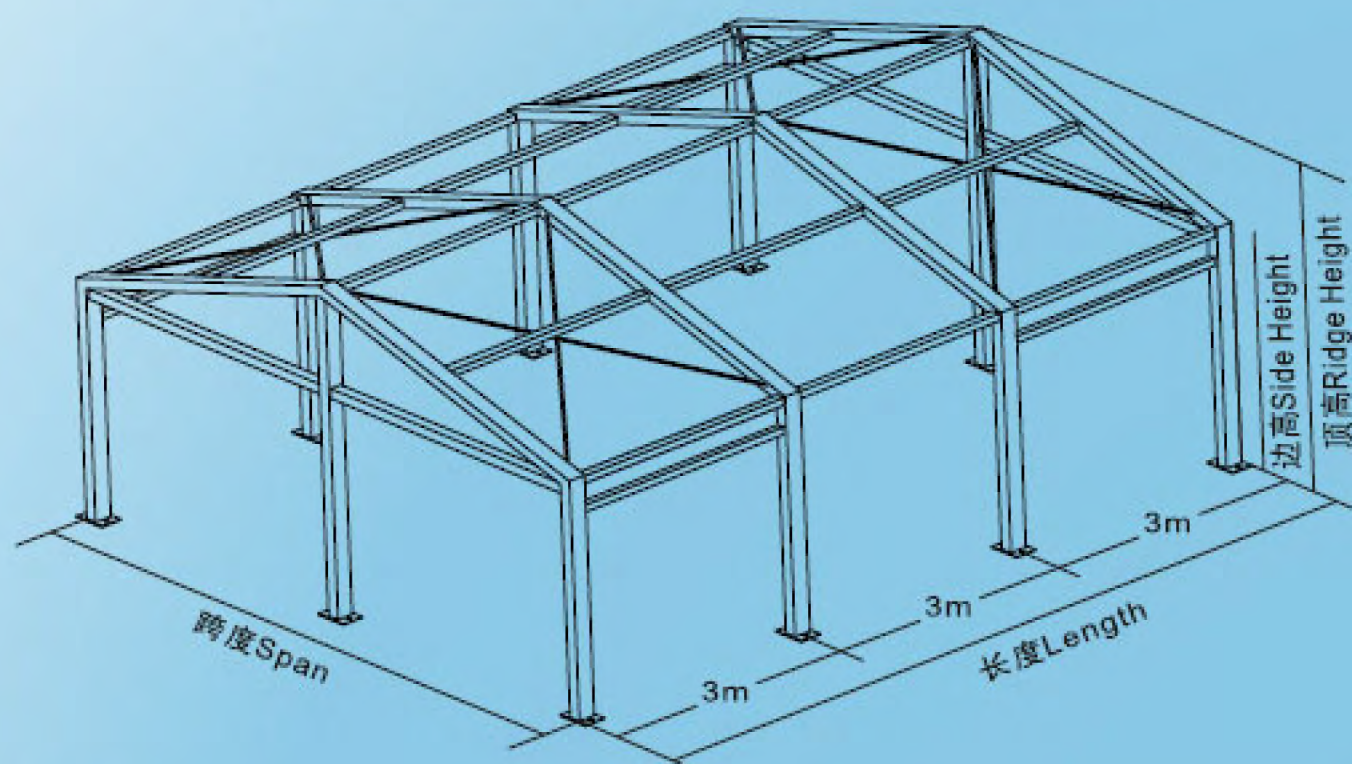
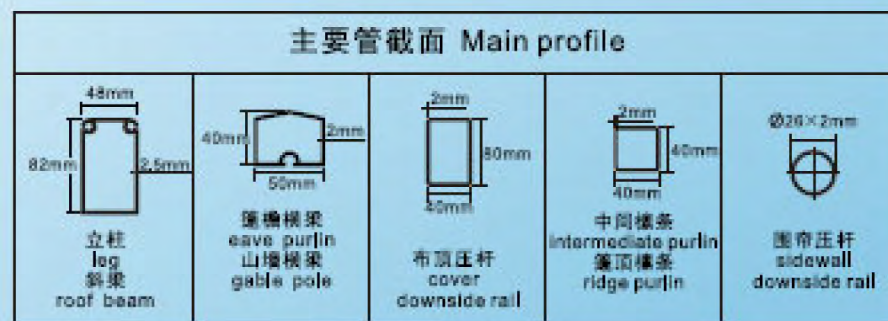

- 支架材料
+ 高强度铝合金型材
表面氧化处理
- 连接方式
+ 内插对接方式
连接件采用钢件
表面镀锌处理
- 篷布材质
+ 双面涂PVC合成
纤维布, 防水、
阻燃、抗紫外线,
抗老化

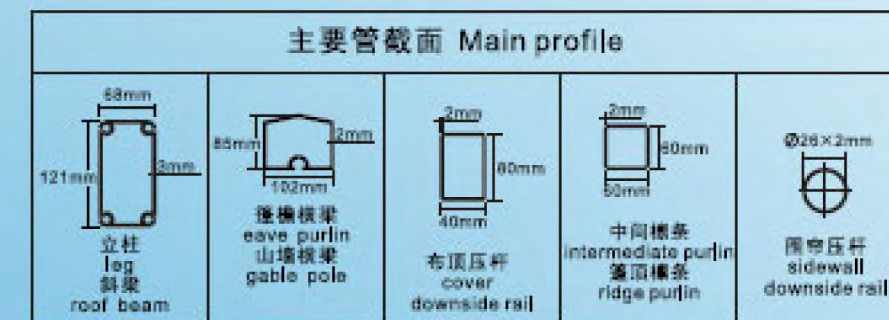

- Frame material
+ high quality aluminum
alloy, oxidation treatment
- Connection
+ inset joint, parts adopt
steel with galvanized
- Cover material
+ polyester with double side
PVC coated, water proof,
flameretardant, uvioresistant,
antiaging

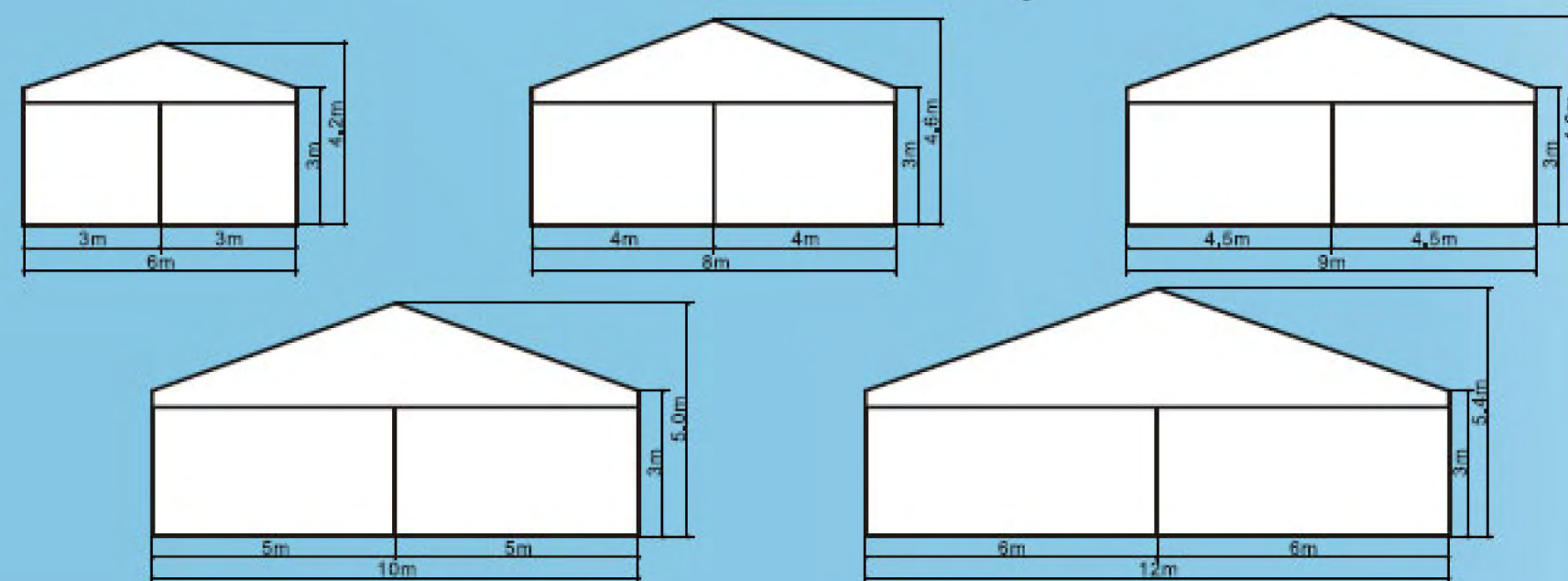
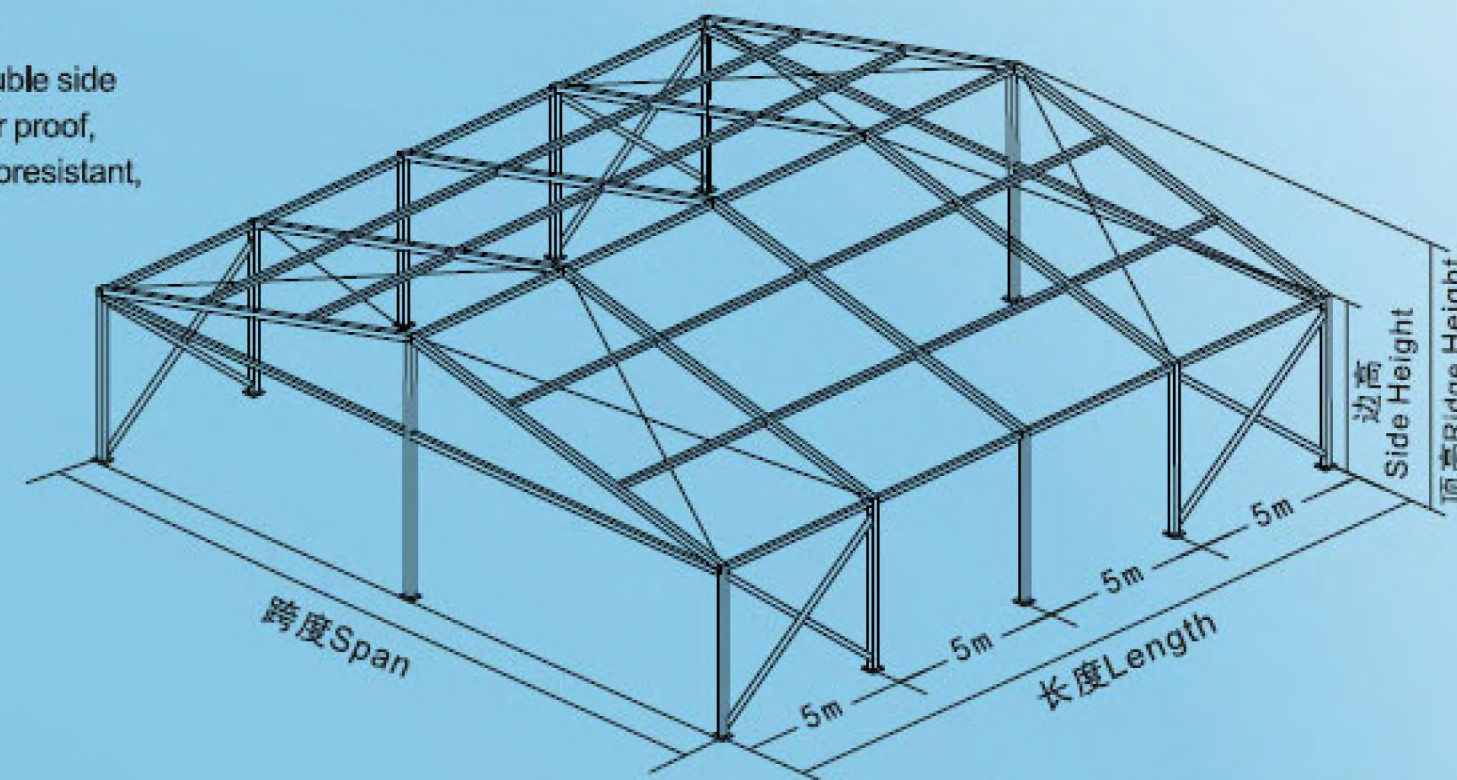



中型篷房 Middle Size Party Tent



主要管截面 Main profile				
<p>立柱 leg 斜梁 roof beam</p>	<p>篷檐横梁 山墙横梁 eave purlin gable pole 篷顶檩条 ridge purlin</p>	<p>布顶压杆 cover downside rail</p>	<p>中间檩条 intermediate purlin</p>	<p>围帘压杆 sidewall downside rail</p>

- 支架材料
+ 高强度铝合金型材
表面氧化处理
- 连接方式
+ 内插对接方式
连接件采用钢件
表面镀锌处理
- 篷布材质
+ 双面涂PVC合成
纤维布, 防水、
阻燃、抗紫外线、
抗老化

主要管截面 Main profile				
<p>立柱 leg 斜梁 roof beam</p>	<p>山墙柱 gable pole</p>	<p>篷檐横梁 山墙横梁 eave purlin gable pole 篷顶檩条 ridge purlin</p>	<p>布顶压杆 cover downside rail</p>	<p>中间檩条 intermediate purlin</p>

- Frame material
+ high quality aluminum
alloy, oxidation treatment
- Connection
+ inset joint, parts adopt
steel with galvanized
- Cover material
+ polyester with double side
PVC coated, water proof,
flameretardant, uvioresistant,
antiaging

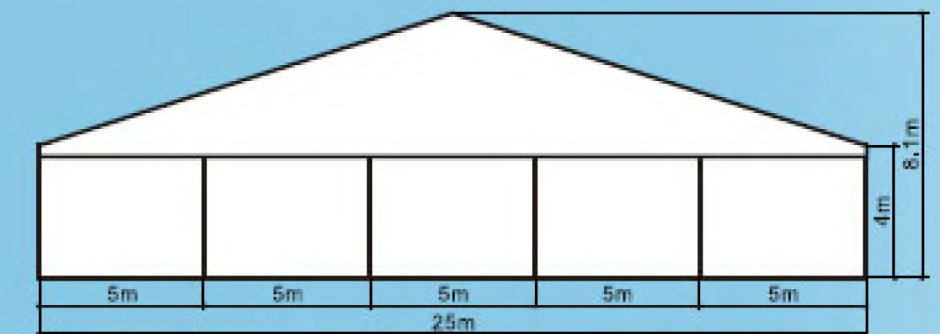
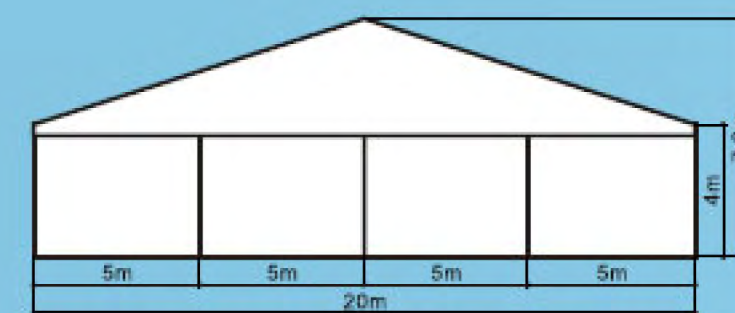
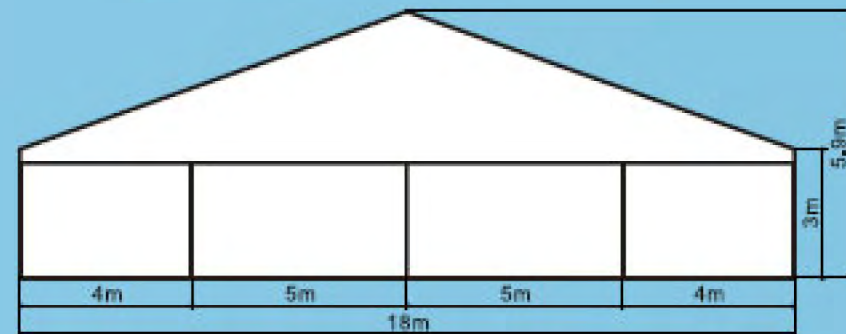
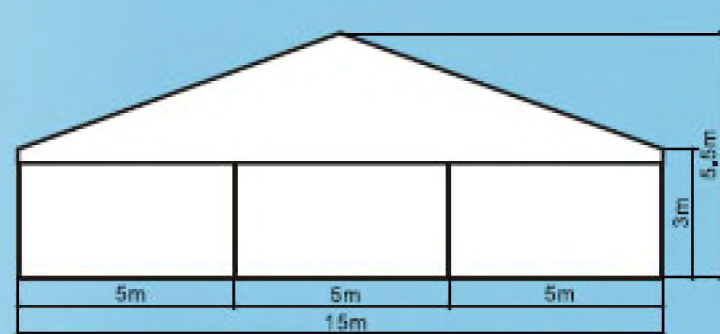
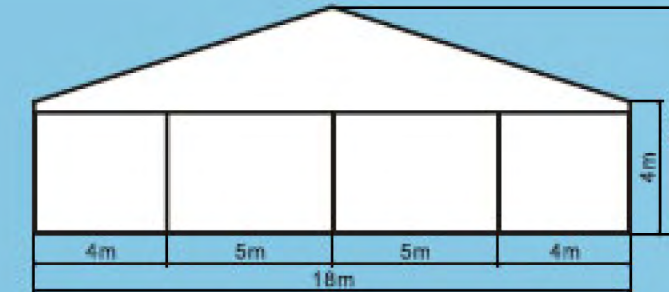
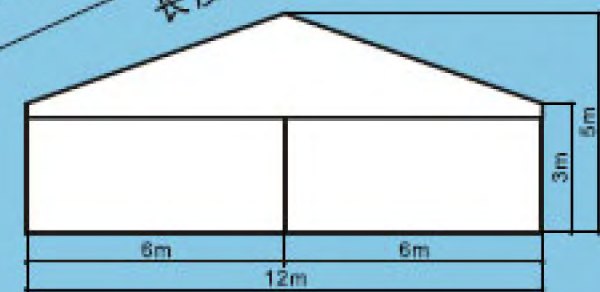
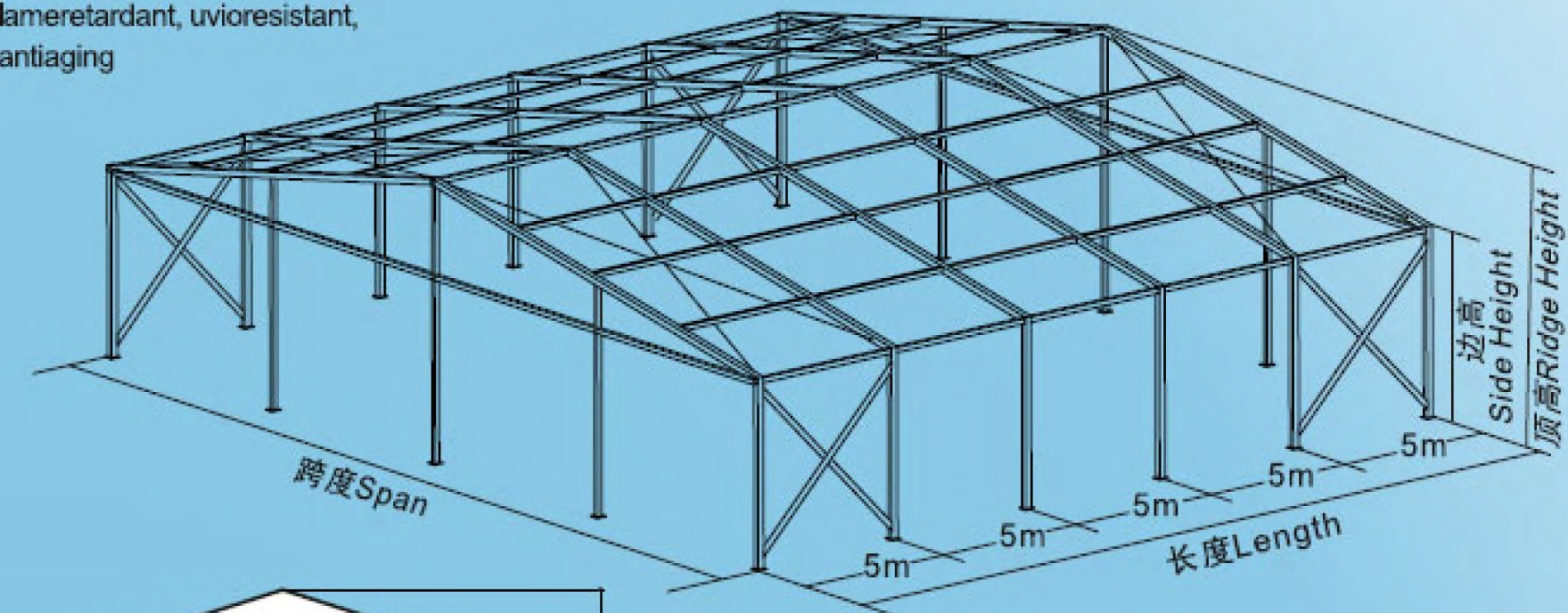
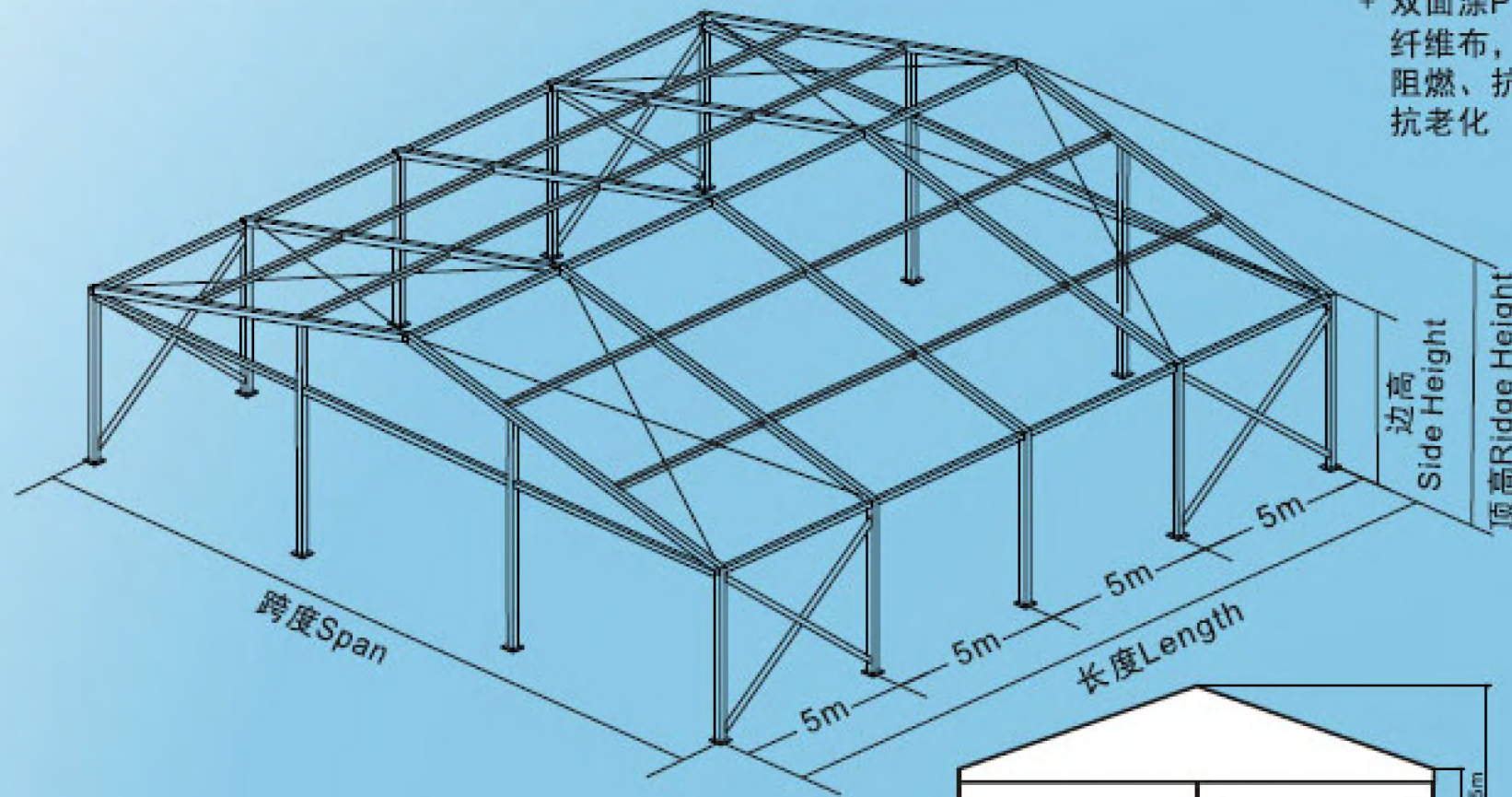



大型篷房

Big Size Party Tent



- 支架材料
+ 高强度铝合金型材
表面氧化处理
- 连接方式
+ 内插对接方式
连接件采用钢件
表面镀锌处理
- 篷布材质
+ 双面涂PVC合成
纤维布, 防水、
阻燃、抗紫外线,
抗老化

- Frame material
+ high quality aluminum
alloy, oxidation treatment
- Connection
+ inset joint, parts adopt
steel with galvanized
- Cover material
+ polyester with double side
PVC coated, water proof,
flameretardant, uvioresistant,
antiaging

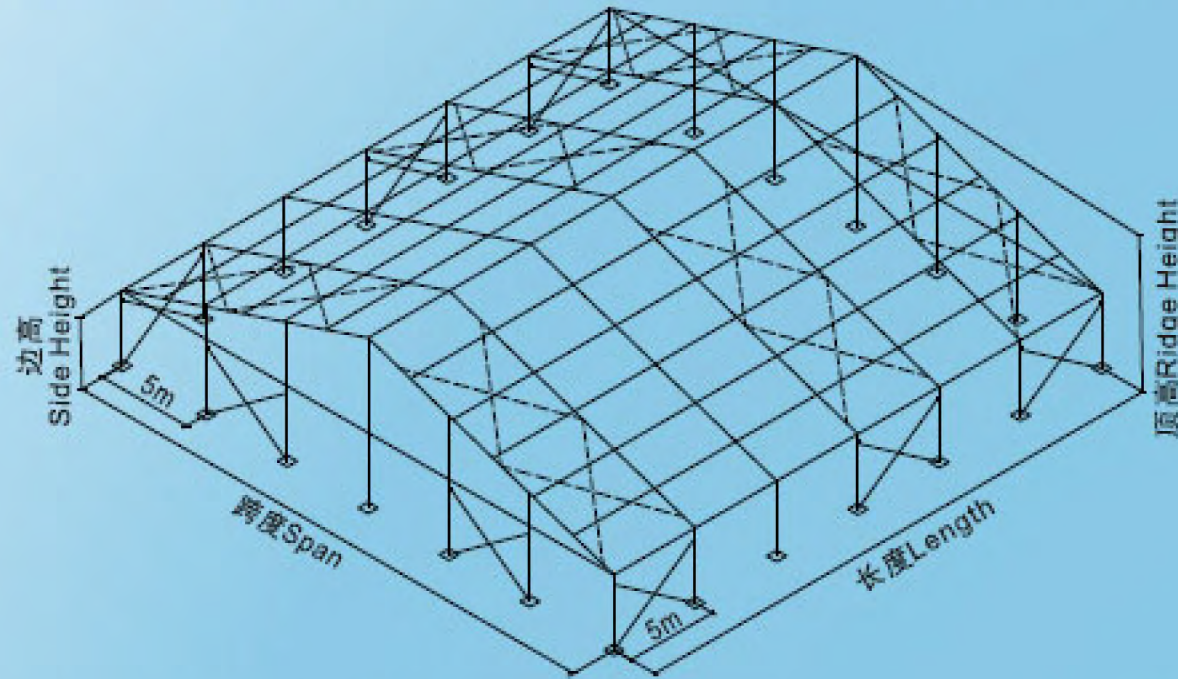

主要管截面 Main profile		
立柱 leg	山墙柱 gable pole	篷顶檩条 eave purlin
110mm 250mm 4mm	88mm 156mm 3mm	85mm 102mm 2mm
篷顶檩条 eave purlin	山墙檩条 gable pole	篷顶檩条 ridge purlin
布顶压杆 cover downside rail	中间檩条 intermediate purlin	篷布压杆 sidewall downside rail
2mm 80mm 40mm	2mm 80mm 60mm	∅12×2mm

主要管截面 Main profile		
立柱 leg	连接件 connection	篷顶檩条 eave purlin
170mm 340mm 6mm	150mm 260mm 8mm	85mm 102mm 2mm
篷顶檩条 eave purlin	山墙檩条 gable pole	篷顶檩条 ridge purlin
山墙柱 gable pole	布顶压杆 cover downside rail	篷布压杆 sidewall downside rail
110mm 203mm 4mm	2mm 80mm 40mm	∅12×2mm

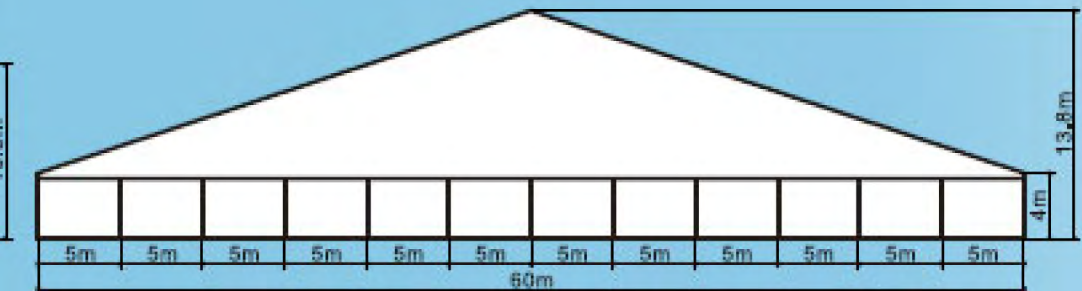
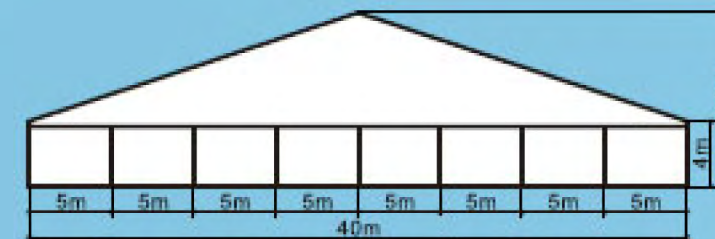
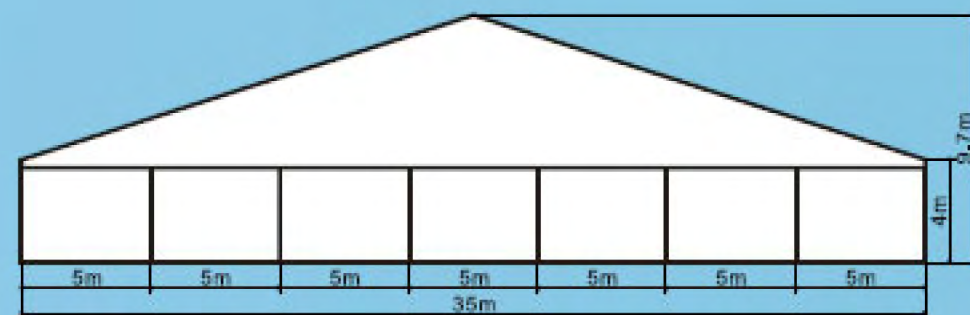
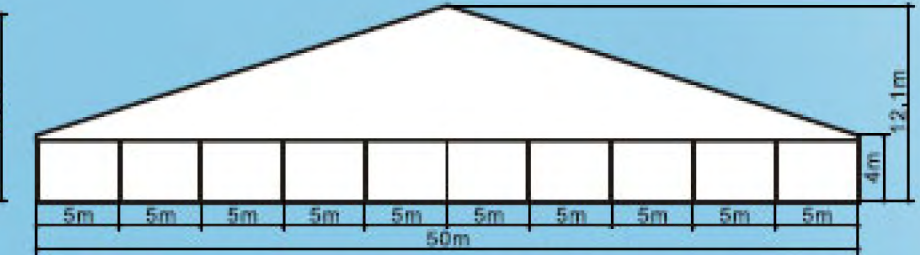
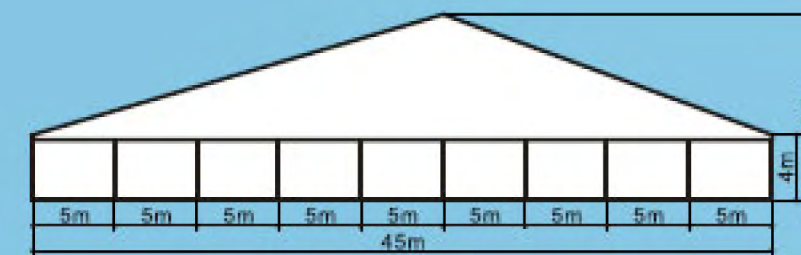
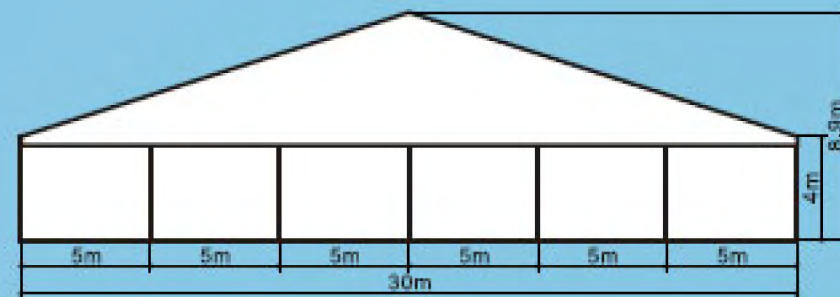
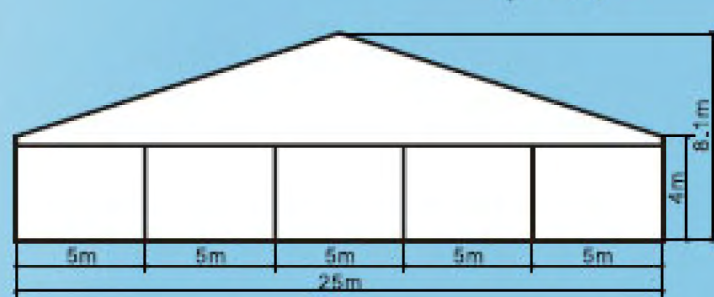
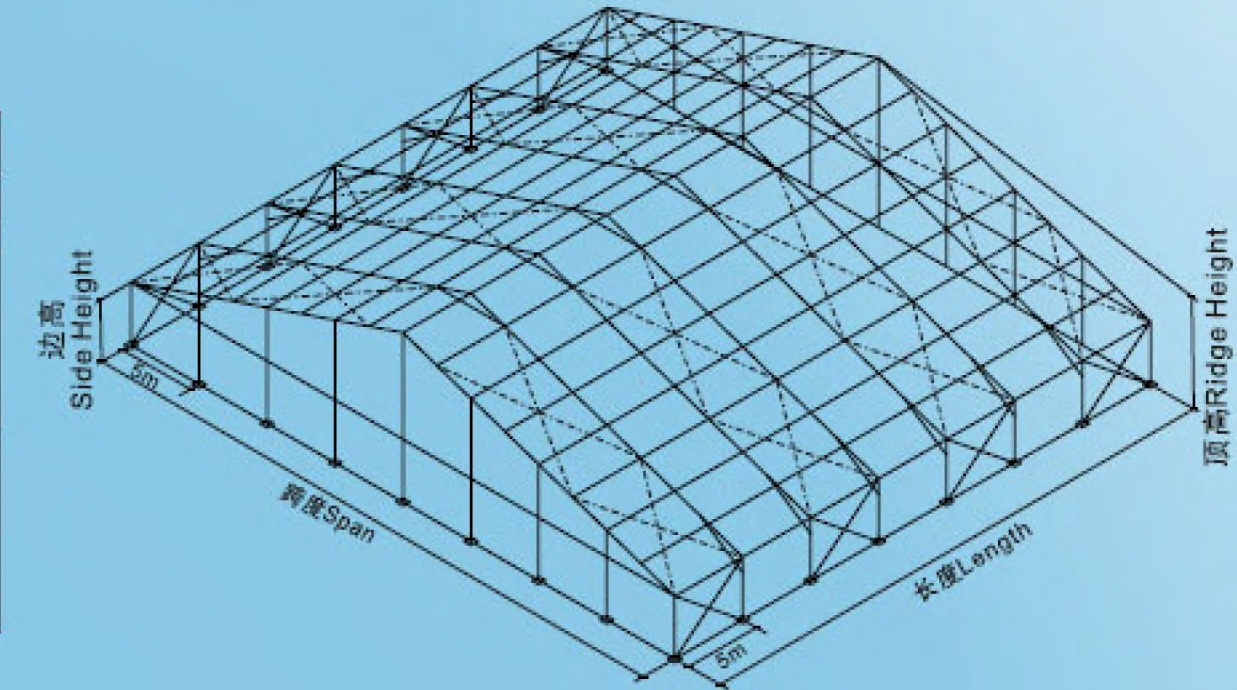



多边形篷 Polygon Tent

实物图 (Pictures)



线图 (line graph)

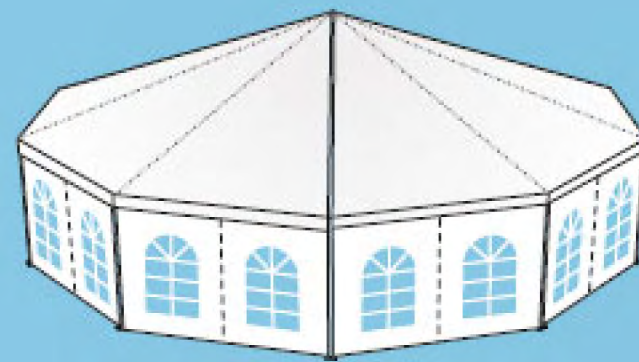
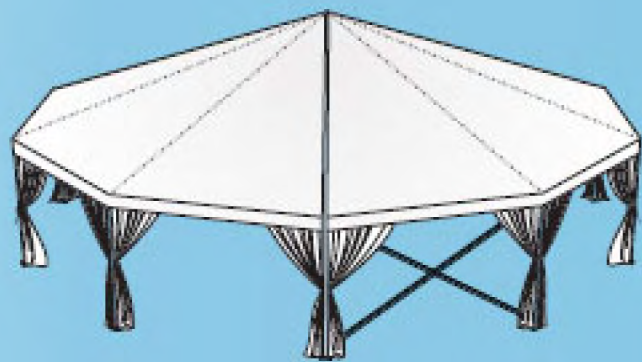
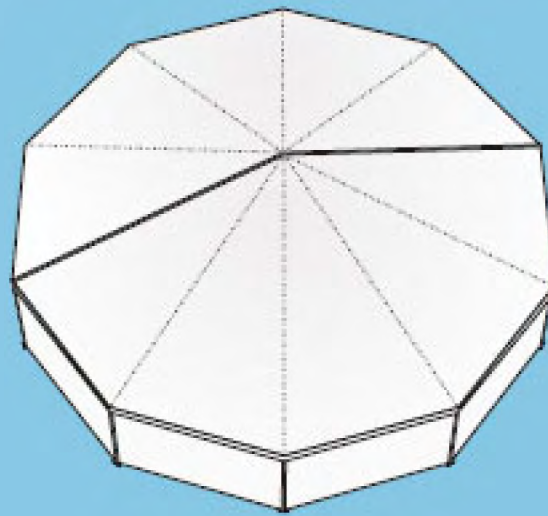

尺寸 (Size)

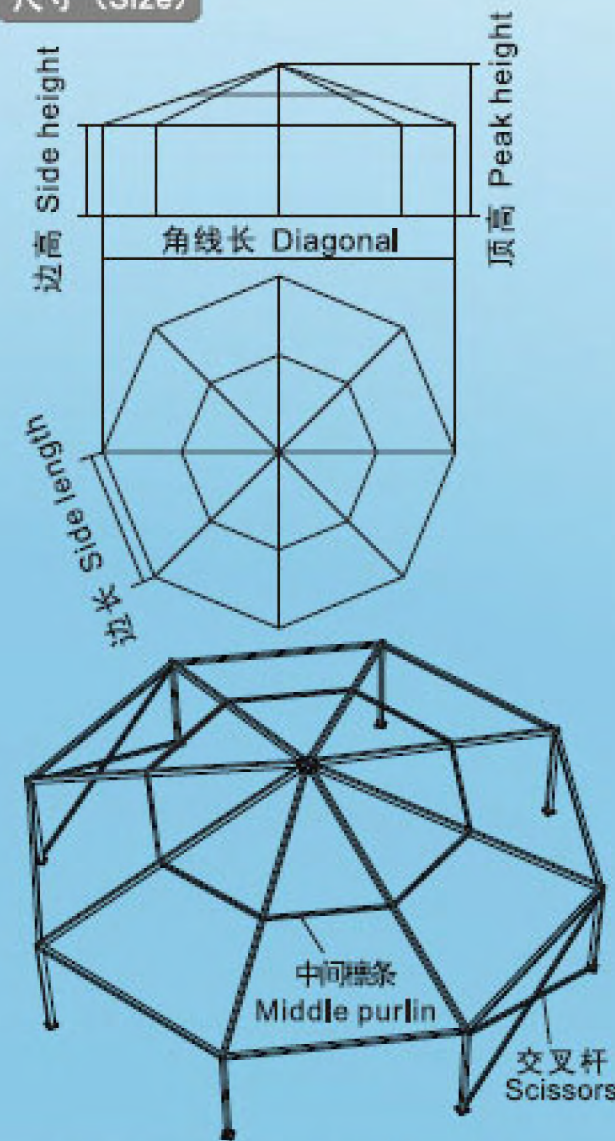

对角线长 Diagonal	10m	15m	20m	25m	30m
正N边形 Regular polygon	8	8	10	12	16
边长 Side length	3.8m	5.7m	6.2m	6.5m	5.9m
边高 Side height	3m	3m	4m	4m	4m
顶高 Peak height	5.0m	5.5m	7.3m	8.1m	8.9m
中间檩条 (条/边) Middle purlin	1	2	3	4	5
交叉杆 (对) Scissors (pairs)	2	2	2	3	4

- 支架材料
+ 高强度铝合金型材
表面氧化处理
- 连接方式
+ 内插对接方式
连接件采用钢件
表面镀锌处理
- 篷布材质
+ 双面涂PVC合成
纤维布, 防水、
阻燃、抗紫外线、
抗老化
- Frame material
+ high quality aluminum
alloy, oxidation treatment
- Connection
+ inset joint, parts adopt
steel with galvanized
- Cover material
+ polyester with double side
PVC coated, water proof,
flameretardant, uvioresistant,
antiaging



主要管截面 Main profile

立柱 leg 斜梁 roof beam 10m diameter	立柱 leg 斜梁 roof beam 15m diameter	立柱 leg 斜梁 roof beam 20m/25m diameter	立柱 leg 斜梁 roof beam 25m/30m diameter
檐檩横梁 eave purlin 山墙横梁 gable pole 篷顶檩条 ridge purlin	布顶压杆 cover downside rail	中间檩条 intermediate purlin	围帘压杆 sidewall downside rail diameter>15m
			围帘压杆 sidewall downside rail diameter≤15m



组合篷房 Combination Tent

实物图 (Pictures)



尺寸 (Size)

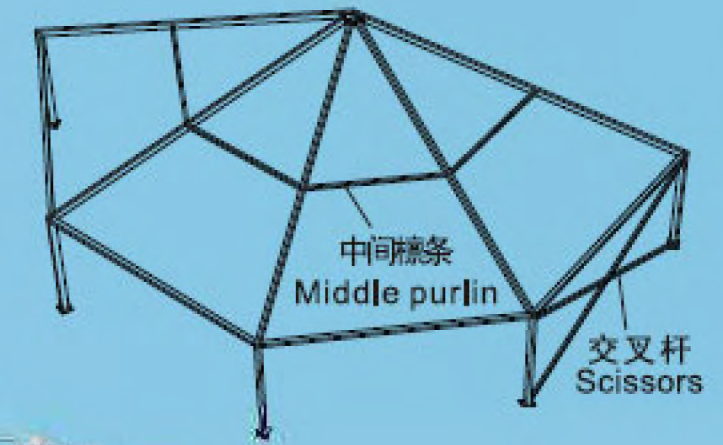
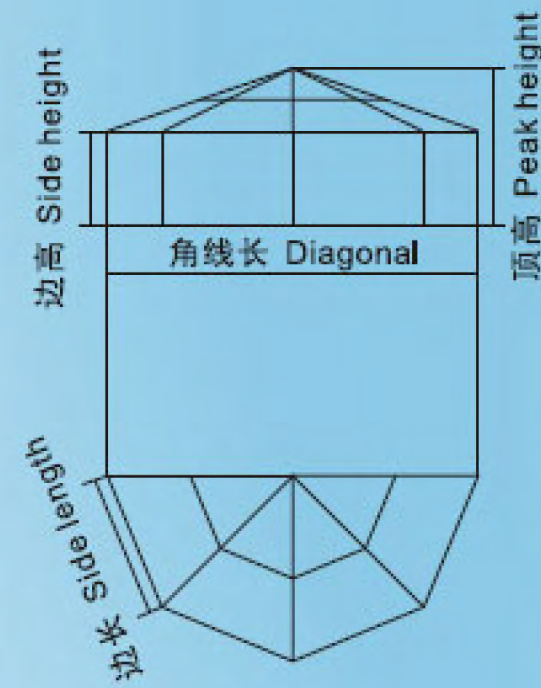

对角线长 Diagonal	10m	15m	20m	25m	30m
篷房跨度 Clear span	10m	15m	20m	25m	30m
正N边形 Regular polygon	8	8	10	12	16
边长 Side length	3.8m	5.7m	6.2m	6.5m	5.9m
边高 Side height	3m	3m	4m	4m	4m
顶高 Peak height	5.0m	5.5m	7.3m	8.1m	8.9m
中间檩条 (条/边) Middle purlin	1	2	3	4	5
交叉杆 (对) Scissors (pairs)	2	2	2	3	4

- 支架材料
+ 高强度铝合金型材
表面氧化处理
- 连接方式
+ 内插对接方式
连接件采用钢件
表面镀锌处理
- 篷布材质
+ 双面涂PVC合成
纤维布, 防水、
阻燃、抗紫外线、
抗老化

- Frame material
+ high quality aluminum
alloy, oxidation treatment
- Connection
+ inset joint, parts adopt
steel with galvanized
- Cover material
+ polyester with double side
PVC coated, water proof,
flameretardant, uvioresistant,
antiaging

主要管截面 Main profile

立柱 leg 斜梁 roof beam 10m diameter	立柱 leg 斜梁 roof beam 15m diameter	立柱 leg 斜梁 roof beam 20m/25m diameter	立柱 leg 斜梁 roof beam 25m/30m diameter
檐檩横梁 eave purlin 山墙横梁 gable pole 篷顶檩条 ridge purlin	布顶压杆 cover downside rail	中间檩条 intermediate purlin	围帘压杆 sidewall downside rail diameter>15m
			围帘压杆 sidewall downside rail diameter≤15m



拱形篷房 Dome Tent

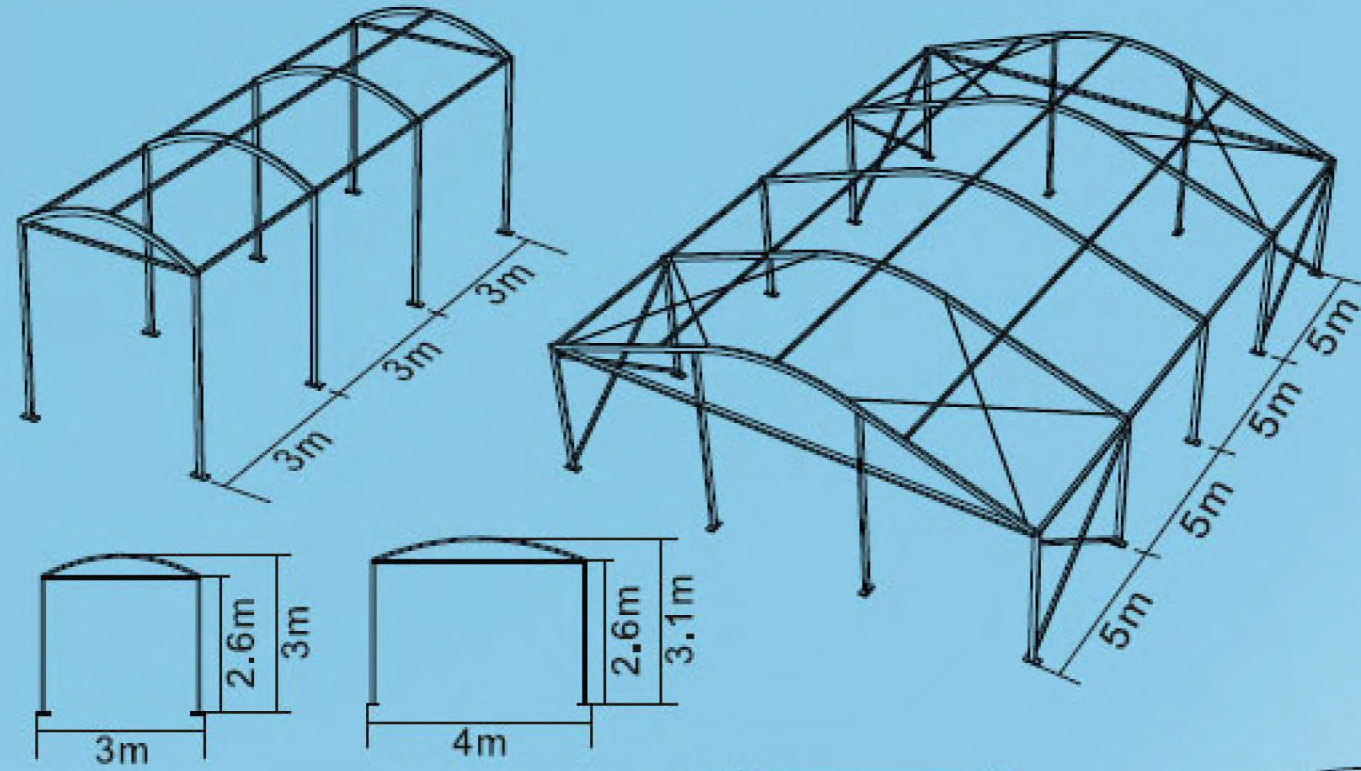

- 支架材料
+ 高强度铝合金型材
表面氧化处理
- 连接方式
+ 内插对接方式
连接件采用钢件
表面镀锌处理
- 篷布材质
+ 双面涂PVC合成
纤维布, 防水、
阻燃、抗紫外线、
抗老化

- Frame material
+ high quality aluminum
alloy, oxidation treatment
- Connection
+ inset joint, parts adopt
steel with galvanized
- Cover material
+ polyester with double side
PVC coated, water proof,
flameretardant, uvioresistant,
antiaging

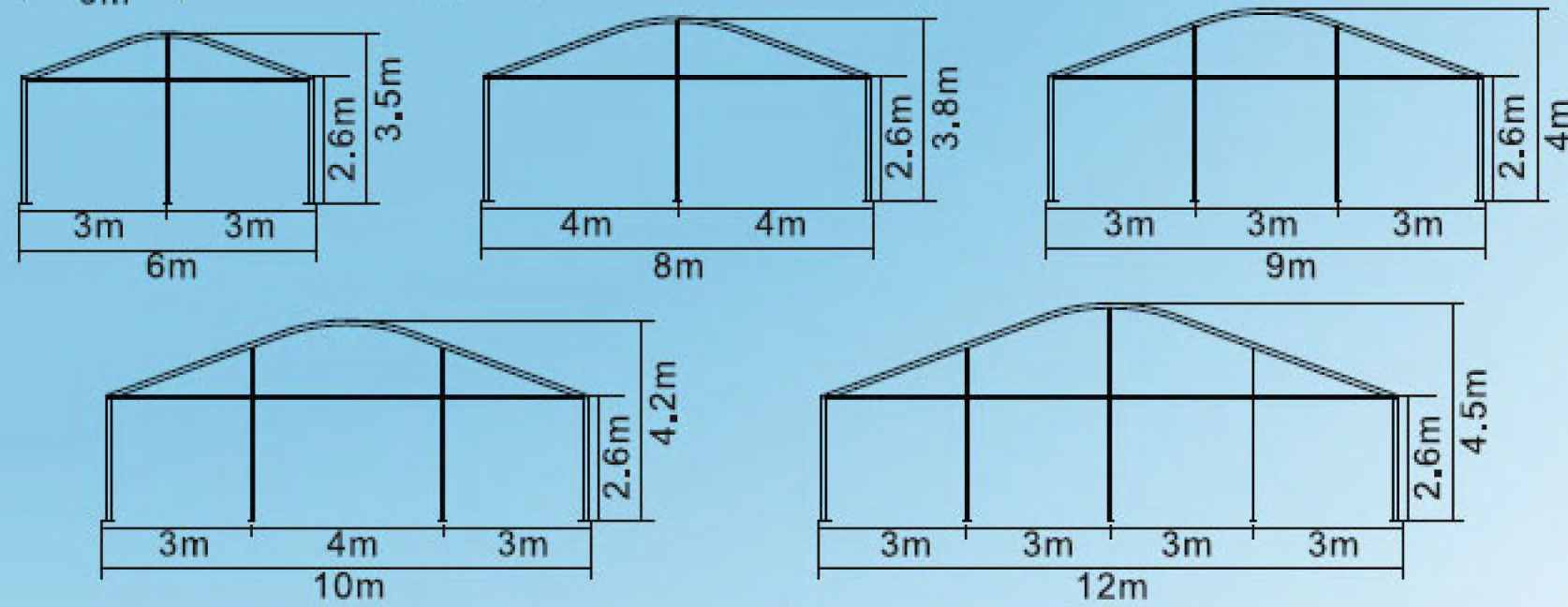

主要管截面 Main profile				
立柱 leg 斜梁 roof beam	篷檐横梁 山墙横梁 gable pole 篷顶檩条 ridge purlin	布顶压杆 cover downside rail	中间檩条 intermediate purlin	围帘压杆 sidewall downside rail

主要管截面 Main profile							
立柱 leg 斜梁 roof beam	篷檐横梁 山墙横梁 gable pole	中间檩条 intermediate purlin 篷顶檩条 ridge purlin	立柱 leg 斜梁 roof beam	篷檐横梁 山墙横梁 gable pole	中间檩条 intermediate purlin 篷顶檩条 ridge purlin	布顶压杆 cover downside rail	围帘压杆 sidewall downside rail
篷房跨度 clear span 3m/4m/6m/8m/9m/10m		篷房跨度 clear span 6m/8m/9m/10m/12m					

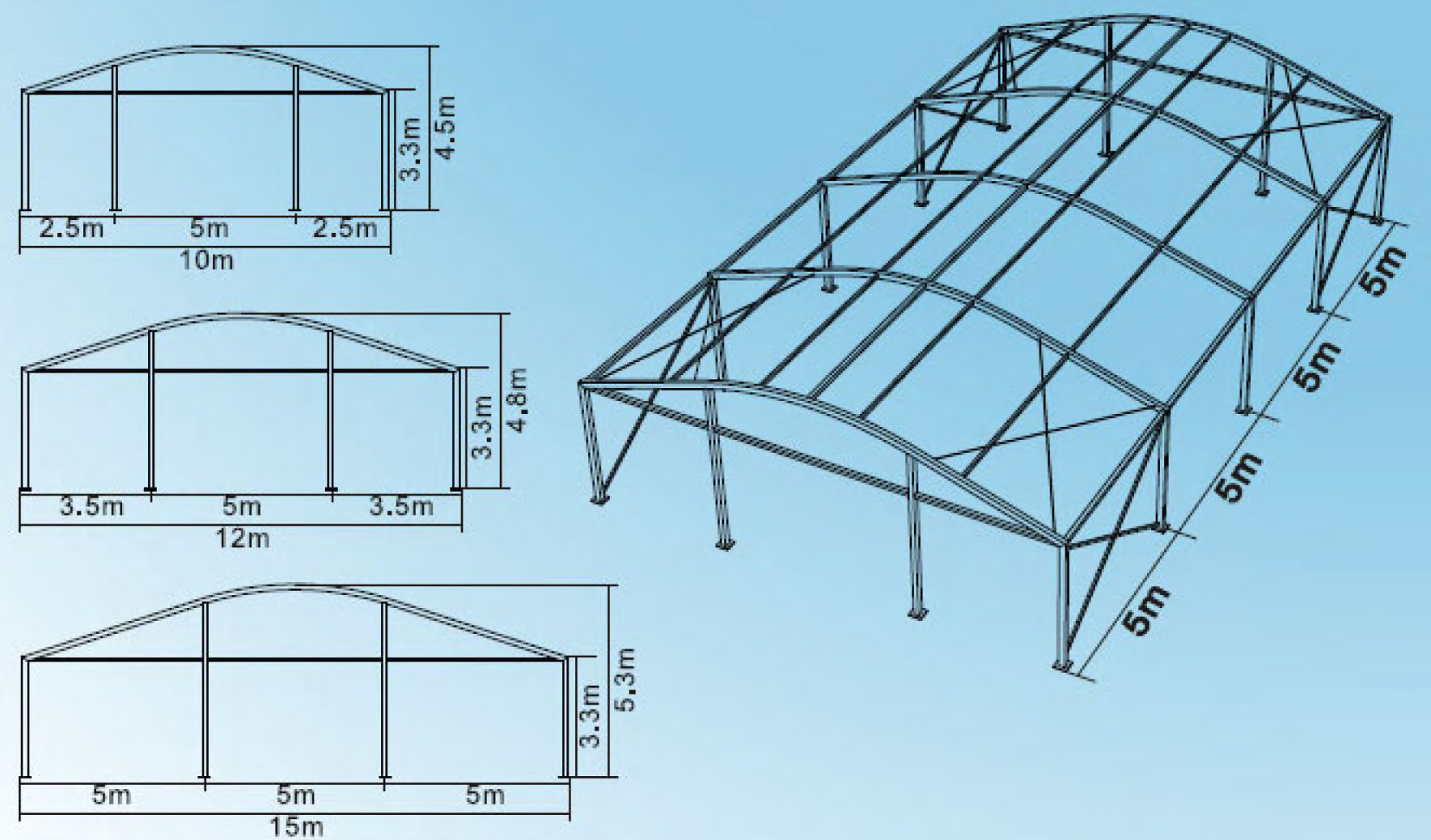



桃形篷房 Curved Tent



主要管截面 Main profile

<p>立柱 leg 斜梁 roof beam</p>	<p>山墙柱 gable pole</p>
<p>屋檐横梁 eave purlin 山墙横梁 gable pole 篷顶檩条 ridge purlin</p>	<p>布顶压杆 cover downside rail</p>
<p>中间檩条 intermediate purlin</p>	<p>围帘压杆 sidewall downside rail</p>

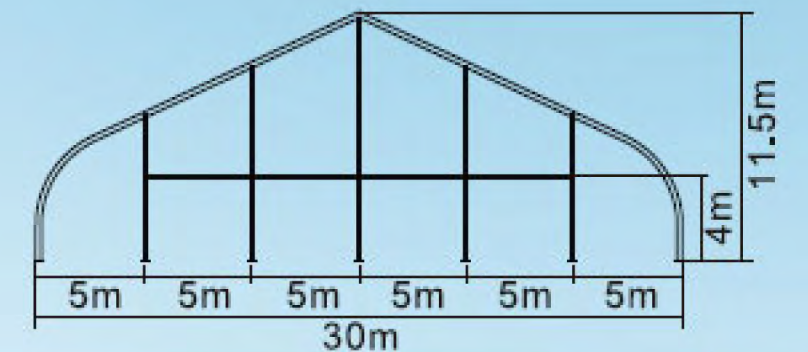
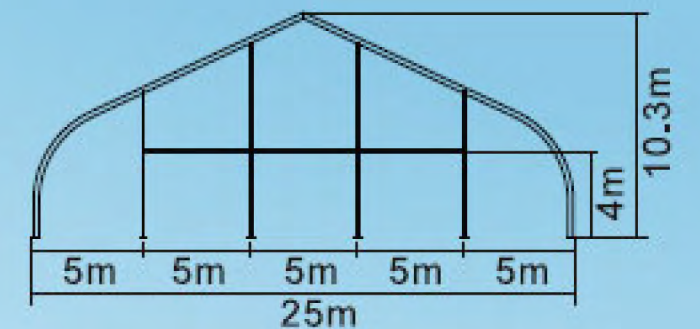
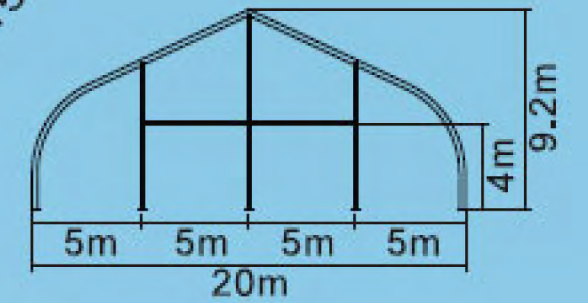
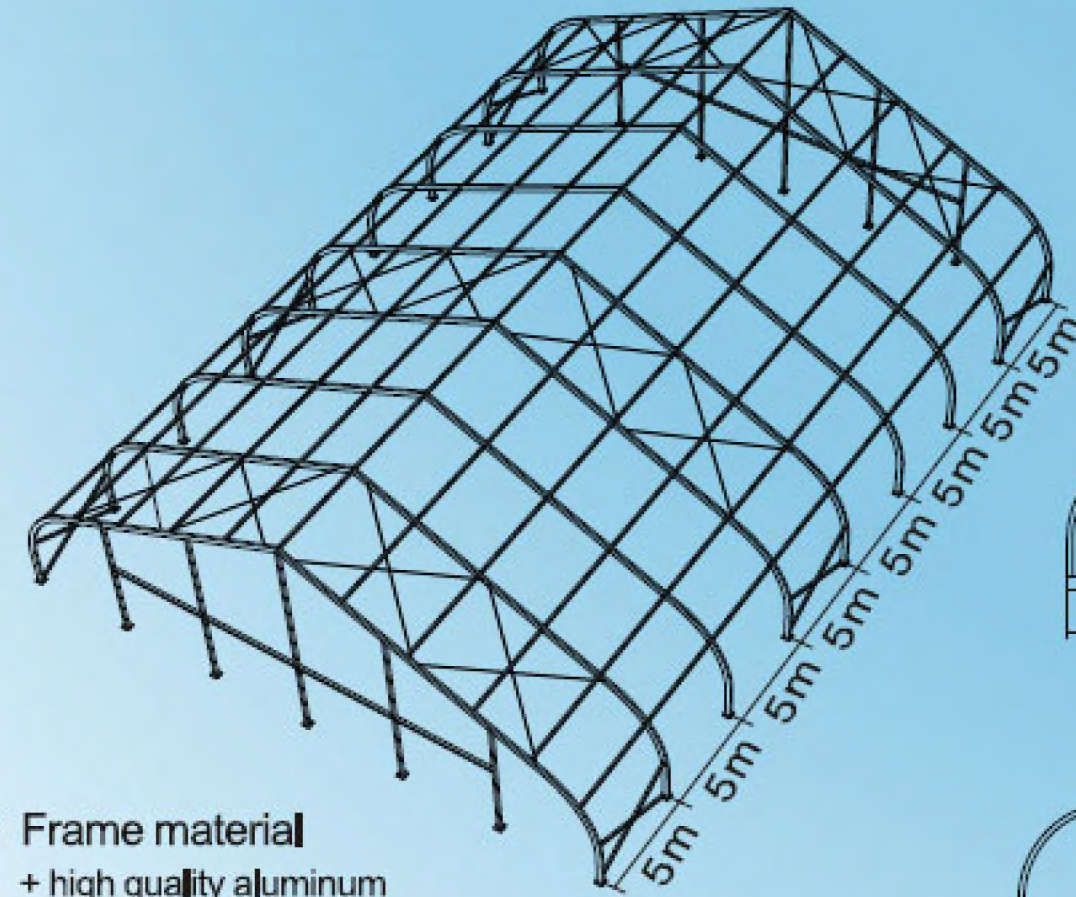
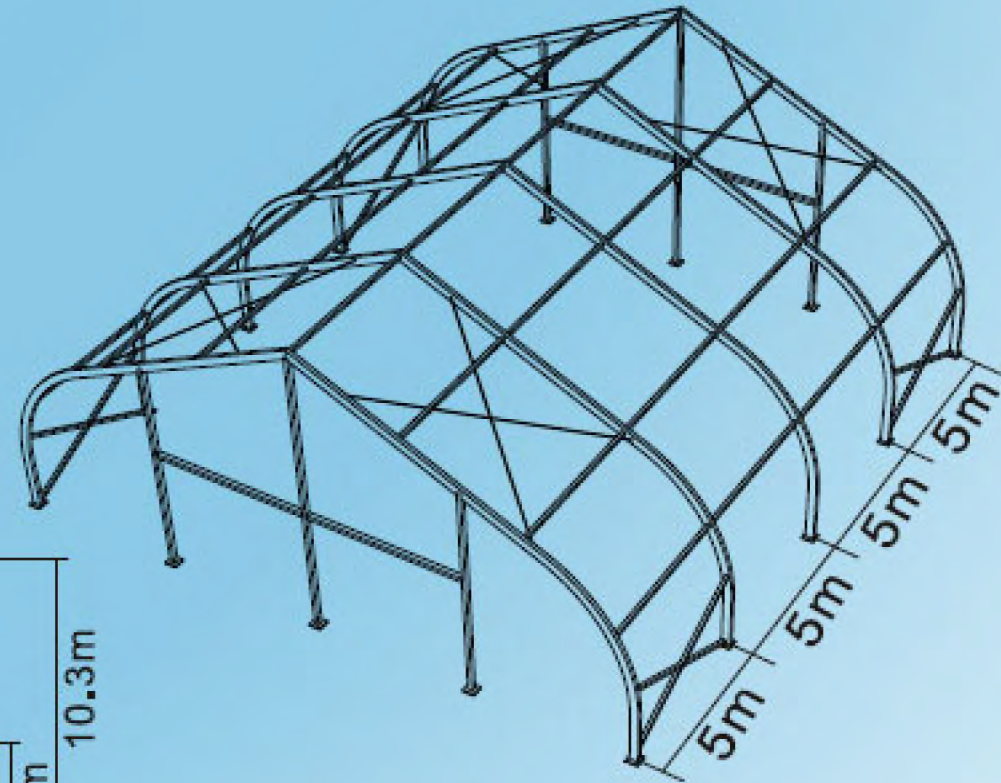
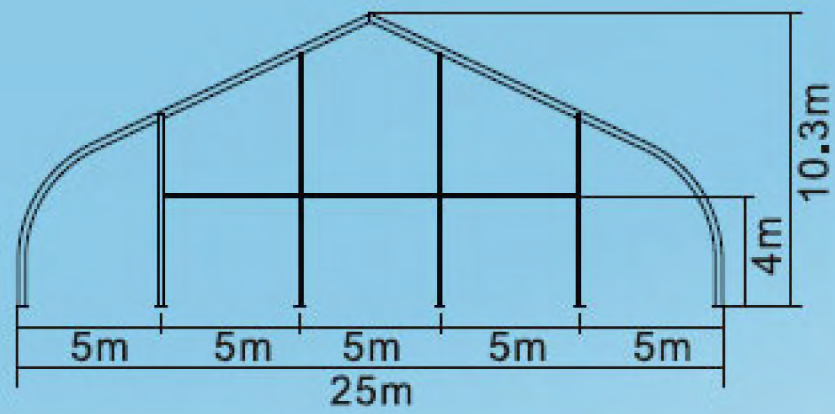
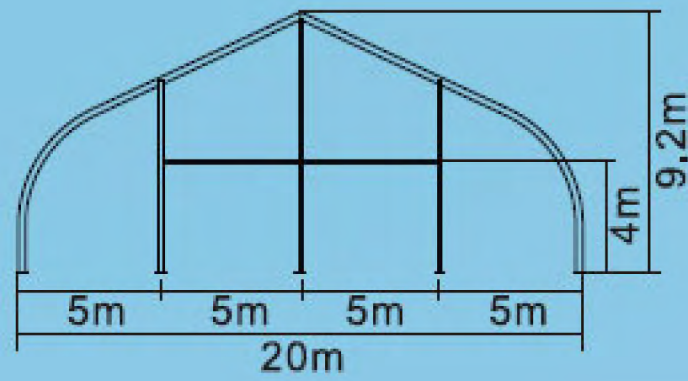

主要管截面 Main profile

<p>立柱 leg 斜梁 roof beam</p>	<p>山墙柱 gable pole</p>	<p>屋檐横梁 eave purlin 山墙横梁 gable pole 篷顶檩条 ridge purlin</p>	<p>布顶压杆 cover downside rail</p>	<p>中间檩条 intermediate purlin</p>	<p>围帘压杆 sidewall downside rail</p>
------------------------------------	---------------------------	---	---	---	--

- 支架材料
+ 高强度铝合金型材
表面氧化处理
- 连接方式
+ 内插对接方式
连接件采用钢件
表面镀锌处理
- 篷布材质
+ 双面涂PVC合成
纤维布, 防水、
阻燃、抗紫外线、
抗老化

- Frame material
+ high quality aluminum
alloy, oxidation treatment
- Connection
+ inset joint, parts adopt
steel with galvanized
- Cover material
+ polyester with double side
PVC coated, water proof,
flameretardant, uvioresistant,
antiaging



可选配件
Optional Accessories



滑动门 sliding door



玻璃门 glass door



玻璃门 glass door



玻璃门 glass door



门口斜板 entrance ramp



地锚 ground anchor



地钉 ground nail



起钉器 nail puller



铝板门 aluminum door



卷闸门 rolling gate



卷门 PVC rolling door



玻璃墙 glass wall



内饰天花窗帘 linings&curtains

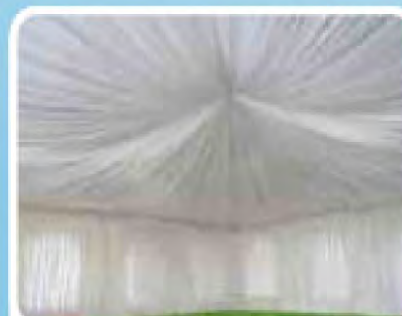

内饰天花窗帘 linings&curtains



内饰天花窗帘 linings&curtains



内饰天花窗帘 linings&curtains



透明墙 clear wall



透明墙 clear wall



硬体墙 sandwich wall



硬体墙 sandwich wall



承重盘 weight plate



承重盘 weight plate

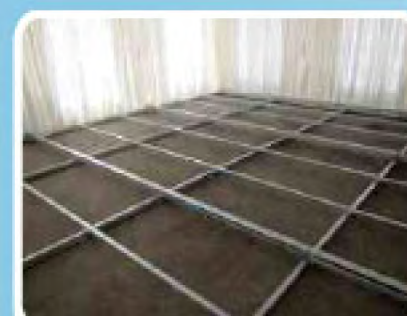

地板系统 floor system



地板系统 floor system



硬体墙 solid wall



硬体墙 solid wall



纱窗 screen window



窗罩 window cover



地毯 carpet



丝网印刷 silk printing



数码喷绘 digital printing



数码喷绘 digital printing



透明窗 transparent window



透明窗 transparent window



水槽 rain gutter



水槽 rain gutter



隔离栏杆 fence



灯饰 lightings

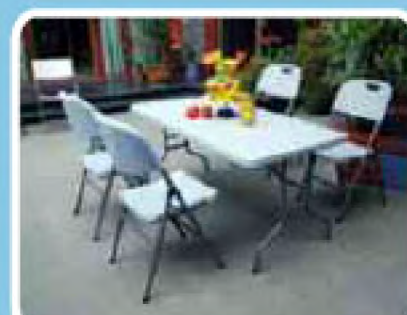

桌椅 table & chair



桌椅 table & chair



小篷 (small party tent)



大篷 (big party tent)





飞型篷安装实例 Star Tent Erecting

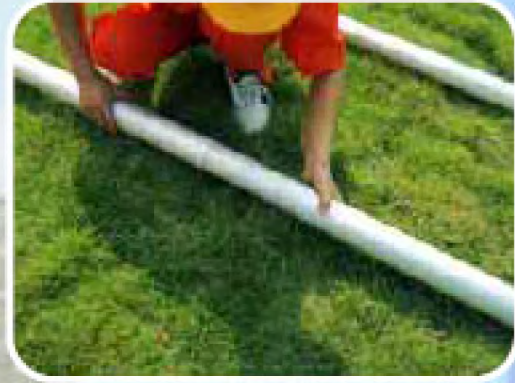

provides you with the latest Storage Tents, Exhibition Tents, Wedding Tents, Industrial Tent, Repository Tent, Convention Tent, Trade Show Tent, Dome Hexagonal Tents, news and related Canopy tent knowledge, and provides the most powerful reference for your purchase journey

