

**Your Trusted Supplier**

Health Care Provider



**Your Trusted Supplier**  
Infection Prevention





# Company Overview

products are manufactured in accordance with the International Quality Standard ISO 9001 and ISO13485 at our wholly owned state-of-the-art manufacturing plant in Hubei (China).

is a leading manufacturer for Surgical Gowns, Drapes, Packs and Protective Apparels. s revenues for year 2012 exceeded \$30m USD and with no debt,

is a paragon of strength and stability financially, strategically and organizationally.

With sales office in the center of we own two manufacturing facilities in Hubei Province, China. Our first plant is located in Caidian District, Wuhan city, with 15,000 square meters production area. Our second plant is in Xiانتao city, with planed 50,000 square meters

production area, resulting in a major increase of our production capacity.

has over 20 professional sales/production/operating/quality staffs and over 500 skilled workers in our HQ and factories. We work with integrity, professionalism and sound industry knowledge to satisfy your requirements. Our innovative team has been working in the non-woven field for many years.



- Business Scope
- Certificates
- Our Mission And Goal

P/02

is the brand under  
Huaxin Non-Woven Co.,Ltd,  
Which is wholly owned by

## Business Scope

has five divisions, and manufactures with more than 100 kinds of surgical products sold to hospitals, Dental Clinics, and Home Care Centers all over the world. Our major product line include:

Surgical Drape & Packs  
Surgical Gowns  
Disposable Protective Apparels  
Disposable Plastic Products  
Chemical Coveralls

### Our Brand Name

MexGown™ MexForce™ MexGuard™  
SuperSoft™ MexPack™

Our Raw Material Partners



## Certificates

Our Company holds TUV, CE0197, ISO9001:2000, ISO13485:2003 and FDA510K certificates.

## Our Mission And Goal

mission is the maximum safety for the patient together with the highest level of comfort and protection for the surgeon. Our goal is to provide our partners the most efficient, cost-effective and high quality infection prevention solutions.

is your most reliable partners to work with. And we win your trust and do business with you by providing the value we bring to you every single day.

## Contact Us At





- What Is Dymex
- Our Mission
- Certificates

P/03



## What Is

For the past 20 years, [Company Name] has been operating in the nonwoven industry and wholeheartedly and continually provided safe and comfortable protective clothing to the users-whether you are working with liquid or solid chemicals, asbestos, paint, or in an environment which is full of oil and other pollutants.

## Our Mission

[Company Name] products always keep the commitment to you – BE SAFE! BE SURE! With this promise always in mind, [Company Name] continues to supply products of good quality, using our extensive experience and knowledge in the nonwoven industry. Our promise is not only to keep you safe and comfortable, but also to give a cost-effective solution. [Company Name] products are CE certified and delivered to you on time – bring you our promise wherever you need them.

## Certificates

TUV, EN ISO13485:2012,  
CE and FDA 510k certificates







## WHAT IS EN 13795?

EN 13795 is a norm that has been approved by CEN on September 6, 2004 and is acknowledged as the European standard that controls and confirms the crucial requirements of all medical devices such as surgical gowns, drapes and clean air suits, both disposable and non disposable textiles.

### Parts of EN13795

1. Basic information for the manufacturers, converters and for the processors such as traceability processes and validation of all steps
2. Testing methods that evaluate specifications explained on Part 1 For instance; EN ISO 22610; resistance to wet microbial penetration  
EN ISO 22612; resistance to dry microbial penetration etc
3. Defining the minimum and maximum standards depending on the conditions of the surgical operations

EN13795-2:2004	
EN ISO 22610:2006	Resistance to wet microbial penetration
EN ISO 22612:2005	Protection against infection agents
EN ISO 9073-10:2003	Assessment of linting and particulate matter
EN 1174-2:1996	Microbial cleanliness
EN 13938-1:1999-wet	Determination of bursting strength
EN 29073-3:1992-wet	Determination of the breaking strength and elongation

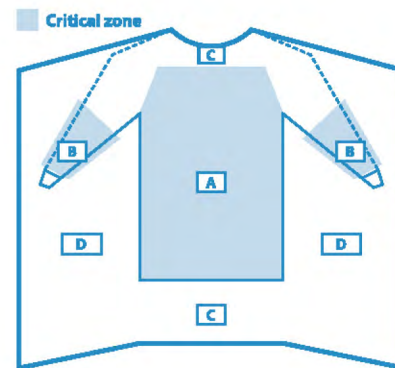

The entire front of a surgical gown (areas A, B and C), including the seam and other components, is required to provide a minimum level of barrier protection (Level 1). Since the back of the gown (area D) intended for surgical applications is expected to stay dry, there is no liquid barrier performance requirements for that area. The critical zones of a surgical gown (areas A and B) can be constructed to provide increased protection (Level 2, 3 or 4). The classification of the entire surgical gown is based on the lowest level of protection within the critical zones.

### Critical zones

The barrier requirements for surgical gowns are based on the location and degree of liquid contact expected during use. The critical zones include those areas where direct contact with blood, body fluids and OPIM are most likely to occur.

## Comfort and Protection

Surgical Gowns provides you a unique balance of comfort, value and protection. We have considered the variety of procedures you work on everyday and ever-changing conditions associated with them.



**MexGown™**

Standard gown made of fluid-repellent nonwoven fabric with a micro-fiber middle layer. High resistance to fluids and bacteria penetration, abrasion-resistant and low-linting.



**MexForce™**

Reinforced gown giving you maximum protection. Made from 5-layers propylene materials with anti-static and fluid resistance.



**MexGuard™**

High Performance Surgical Gown with increased breathability and comfort. Made from 5-layers Polypropylene materials with alcohol, blood, anti static and fluid resistance.

## What will you be wearing?

It's important to choose the right gown for the right procedure. Clinicians and surgeons should begin the surgical gown selection process by considering the following test.

### Strike-through resistance test (in cm)

↑ Higher is better



### Puncture resistance test (in psi)

↑ Higher is better



### Strength test (machine direction in lbs.)

↑ Higher is better



### Lint test (in number of particles ≧ 1micron)

↓ Lower is better





# Surgical Gown

- SMMMS Standard Surgical Gown
- SMS Standard Surgical Gown

P/07

## MEXGOWN™

### SMMMS Standard Surgical Gown

- SMMMS Fabric
- Fluid Repellent
- Abrasion-Resistant
- Low-Linting
- Aseptic Folding
- Ultrasonic Welding or Three thread over-lock Serged seam
- Knitted Cuff
- Latex free

Code	Product Name	Specification	Packaging
SGS10-35	Standard Gown	35gsm, Non sterile	5pcs/bag, 40pcs/case
SGS10-40	Standard Gown	40gsm, Non sterile	5pcs/bag, 40pcs/case
SGS10-45	Standard Gown	45gsm, Non sterile	5pcs/bag, 40pcs/case
SGS10-50	Standard Gown	50gsm, Non sterile	5pcs/bag, 40pcs/case
SGS11-35	Standard Gown	35gsm, sterile	1pc/sterile pouch, 25pcs/case
SGS11-40	Standard Gown	40gsm, sterile	1pc/sterile pouch, 25pcs/case
SGS11-45	Standard Gown	45gsm, sterile	1pc/sterile pouch, 25pcs/case
SGS11-50	Standard Gown	50gsm, sterile	1pc/sterile pouch, 25pcs/case

Note: Sterile gowns could include towel and wrapper in the package.

### SMS Standard Surgical Gown

- SMS Fabric with matte finish
- Fluid Repellent
- Abrasion-Resistant
- Low-Linting
- Aseptic Folding
- Ultrasonic Welding or Three thread over-lock Serged seam
- Knitted Cuff
- Latex free

Code	Product Name	Specification	Packaging
SGS12-35	Disposable Gown	35gsm, Non sterile	5pcs/bag, 40pcs/case
SGS12-40	Disposable Gown	40gsm, Non sterile	5pcs/bag, 40pcs/case
SGS13-35	Disposable Gown	35gsm, sterile	1pc/sterile pouch, 25pcs/case
SGS13-40	Disposable Gown	40gsm, sterile	1pc/sterile pouch, 25pcs/case

Note: Sterile gowns could include towel and wrapper in the package.

# Surgical Gown

## MEXFORCE™

- SMMMS Poly-Reinforced Surgical Gown
- SMMMS Fabric-Reinforced Surgical Gown

P/08

### SMMMS Poly-Reinforced Surgical Gown

- SMMMS Fabric
- Fluid/Blood Repellent
- Abrasion-Resistant
- Low-Linting
- Aseptic Folding
- Ultrasonic Welding
- Knitted Cuff
- Latex free
- Plastic Film or Breathable Film Lamination Reinforced
- Critical zone reinforced optional

Code	Product Name	Specification	Packaging
SGRF10-35	Poly-Reinf. Gown	35gsm, Non sterile	5pcs/bag, 40pcs/case
SGRF10-40	Poly-Reinf. Gown	40gsm, Non sterile	5pcs/bag, 40pcs/case
SGRF10-45	Poly-Reinf. Gown	45gsm, Non sterile	5pcs/bag, 40pcs/case
SGRF11-35	Poly-Reinf. Gown	35gsm, sterile	1pc/sterile pouch, 25pcs/case
SGRF11-40	Poly-Reinf. Gown	40gsm, sterile	1pc/sterile pouch, 25pcs/case
SGRF11-45	Poly-Reinf. Gown	45gsm, sterile	1pc/sterile pouch, 25pcs/case

Note: Sterile gowns could include towel and wrapper in the package.

### SMMMS Fabric-Reinforced Surgical Gown

- SMMMS Fabric
- Fluid Repellent
- Abrasion-Resistant
- Low-Linting
- Aseptic Folding
- Ultrasonic Welding
- Knitted Cuff
- Latex free
- Plastic Film or Breathable Film Lamination Reinforced
- Critical zone reinforced optional

Code	Product Name	Specification	Packaging
SGRF12-35	Fabric-Reinf. Gown	35gsm, Non sterile	5pcs/bag, 40pcs/case
SGRF12-40	Fabric-Reinf. Gown	40gsm, Non sterile	5pcs/bag, 40pcs/case
SGRF12-45	Fabric-Reinf. Gown	45gsm, Non sterile	5pcs/bag, 40pcs/case
SGRF13-35	Fabric-Reinf. Gown	35gsm, sterile	1pc/sterile pouch, 25pcs/case
SGRF13-40	Fabric-Reinf. Gown	40gsm, sterile	1pc/sterile pouch, 25pcs/case
SGRF13-45	Fabric-Reinf. Gown	45gsm, sterile	1pc/sterile pouch, 25pcs/case

Note: Sterile gowns could include towel and wrapper in the package.





# Surgical Gown

- High Performance Standard Surgical Gown
- High Performance Reinforced Surgical Gown

P/09

## MEXGUARD™

### High Performance Standard Surgical Gown

SMMMS Fabric with AR/AS Treatment  
 Fluid Repellent  
 Abrasion-Resistant  
 Alcohol Repellent:AR6-8/AR9-10  
 Blood Repellent  
 Anti-Static  
 Low-Linting  
 Aseptic Folding  
 Ultrasonic Welding  
 Knitted Cuff  
 Latex free

Code	Product Name	Specification	Packaging
SGHP10-35	Standard Gown	35gsm,Non sterile	5pcs/bag,40pcs/case
SGHP10-40	Standard Gown	40gsm,Non sterile	5pcs/bag,40pcs/case
SGHP10-45	Standard Gown	45gsm,Non sterile	5pcs/bag,40pcs/case
SGHP10-50	Standard Gown	50gsm,Non sterile	5pcs/bag,40pcs/case
SGHP11-35	Standard Gown	35gsm,sterile	1pc/sterile pouch,25pcs/case
SGHP11-40	Standard Gown	40gsm,sterile	1pc/sterile pouch,25pcs/case
SGHP11-45	Standard Gown	45gsm,sterile	1pc/sterile pouch,25pcs/case
SGHP11-50	Standard Gown	50gsm,sterile	1pc/sterile pouch,25pcs/case

Note: Sterile gowns could include towel and wrapper in the package.

### High Performance Reinforced Surgical Gown

SMMMS Fabric  
 Fluid Repellent  
 Abrasion-Resistant  
 Alcohol Repellent:AR6-8/AR9-10  
 Blood Repellent  
 Anti-Static  
 Low-Linting  
 Aseptic Folding  
 Ultrasonic Welding  
 Knitted Cuff  
 Latex free  
 PP+PE,SMS,Microporous Film Reinforcement  
 Half Reinforcement or Full Reinforcement

Code	Product Name	Specification	Packaging
SGHPR10-35	Reinforced Gown	35gsm,Non sterile	5pcs/bag,40pcs/case
SGHPR10-40	Reinforced Gown	40gsm,Non sterile	5pcs/bag,40pcs/case
SGHPR10-45	Reinforced Gown	45gsm,Non sterile	5pcs/bag,40pcs/case
SGHPR10-50	Reinforced Gown	50gsm,Non sterile	5pcs/bag,40pcs/case
SGHPR11-35	Reinforced Gown	35gsm,sterile	1pc/sterile pouch,25pcs/case
SGHPR11-40	Reinforced Gown	40gsm,sterile	1pc/sterile pouch,25pcs/case
SGHPR11-45	Reinforced Gown	45gsm,sterile	1pc/sterile pouch,25pcs/case
SGHPR11-50	Reinforced Gown	50gsm,sterile	1pc/sterile pouch,25pcs/case

Note: Sterile gowns could include towel and wrapper in the package.



# Surgical Gown

## SUPERSOFT™

- Spunlace Standard Surgical Gown
- Spunlace Reinforced Surgical Gown

P/10

### Spunlace Standard Surgical Gown

Spunlace Material  
 Fluid Repellent  
 Abrasion-Resistant  
 Anti-Static  
 Low-Linting  
 Aseptic Folding  
 Double Stiches  
 Knitted Cuff  
 Latex free

Code	Product Name	Specification	Packaging
SGSP10	Standard Gown	68gsm,Non sterile	5pcs/bag,40pcs/case
SGSP12	Standard Gown	68gsm,sterile	1pc/sterile pouch,25pcs/case

Note: Sterile gowns could include towel and wrapper in the package.

### Spunlace Reinforced Surgical Gown

Spunlace Material  
 Fluid Repellent  
 Abrasion-Resistant  
 Anti-Static  
 Low-Linting  
 Aseptic Folding  
 Double Stiches  
 Knitted Cuff  
 Latex free  
 PP+PE,Microporous Film Reinforcement  
 Half Reinforcement or Full Reinforcement

Code	Product Name	Specification	Packaging
RGSP10	Reinforced Gown	68gsm,Non sterile	5pcs/bag,40pcs/case
RGSP12	Reinforced Gown	68gsm,sterile	1pc/sterile pouch,25pcs/case

Note: Sterile gowns could include towel and wrapper in the package.





# Surgical Drapes and Packs



## Surgical Drape Packs Provide A Convenient Solution For Everyday Draping

### Absorbent

The absorbent qualities of the fabric controls and contains fluid, reducing clean-up time, potential exposure to body fluids and risk to staff from fluid on the floor.

### Impervious

The fluid control and impervious features of the fabric mean that only a single layer of drapes is required. Our surgical drapes are impervious to liquid strike through which can help to reduce bacterial transfer and subsequent contamination of the surgical site.

### Adhesion

3M is a leader in adhesive technology and has applied this expertise to provide surgical drapes with consistently reliable adhesion to the skin. Thanks to our reliable partner 3M, we are able to ensure the adhesion of all surgical drapes and pack.

## Index

### General Surgery Packs

Universal Pack with Mayo Stand Cover	13
Universal Pack without Mayo Stand Cover	13
Universal Pack with Mayo Stand Cover & Gown	13
Laparotomy Pack	14
Laparoscopy Pack I	14
Laparoscopy Pack II	14

### Urology & Gynecology Packs

Obstetrical Pack	15
Delivery Pack	15
Cystoscopy Pack	15
Gynaecology Pack I	16
Gynaecology Pack II	16
Curetage Set	16
Cesarean Pack I	17
Cesarean Pack II	17
T.U.R Pack	17

### Cardiovascular Packs

Angiography Pack I	18
Angiography Pack II	18
Cardiovascular Pack	18

### Neurosurgery Packs

Craniotomy Pack	19
Spinal Pack	19

### Orthopedics Packs

General Orthopedics Pack	20
Hand & Foot Pack	20
Extremity Pack	20

### Arthroscopy Packs

Arthroscopy Pack I	21
Arthroscopy Pack II	21
Shoulder Pack	21

### Hip Packs

Hip Pack I	22
Hip Pack II	22

### Ophthalmology Packs

Ophthalmology Pack I	23
Ophthalmology Pack II	23
Ophthalmology Pack III	23
E.N.T Pack	23

### Surgical Drapes

U Drapes & Special Drapes	24
General Drapes	24
Special Drapes	24
Other Components	24



# Surgical Drapes and Packs

## GENERAL SURGERY PACKS

- Universal Pack with Mayo Stand Cover
- Universal Pack without Mayo Stand Cover
- Universal Pack with Mayo Stand Cover & Gown

P/13

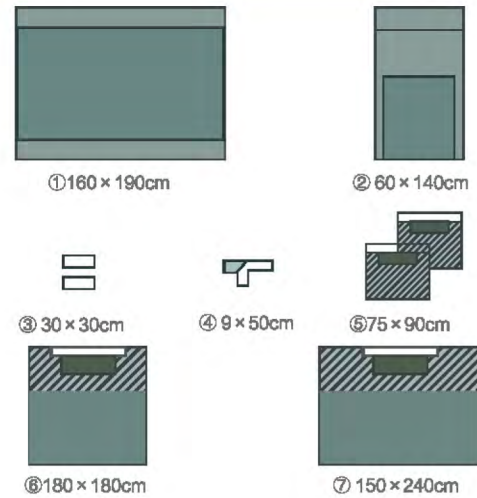

### Universal Pack with Mayo Stand Cover REF A011

No.	Product Name	Size	Quantity
1	Back Table Cover	160*190cm	1
2	Mayo Stand Cover	60*140cm	1
3	Hand Towels	30*30cm	2
4	Op-Tape	9*50cm	1
5	Adhesive Side Drapes	75*90cm	2
6	Adhesive Bottom Drape	180*180cm	1
7	Adhesive Top Drape	150*240CM	1

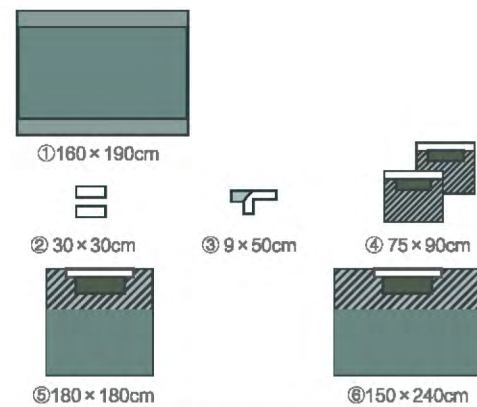

### Universal Pack without Mayo Stand Cover REF A012

No.	Product Name	Size	Quantity
1	Back Table Cover	160*190cm	1
2	Hand Towels	30*30cm	2
3	Op-Tape	9*50cm	1
4	Adhesive Side Drapes	75*90cm	2
5	Adhesive Bottom Drape	180*180cm	1
6	Adhesive Top Drape	150*240CM	1

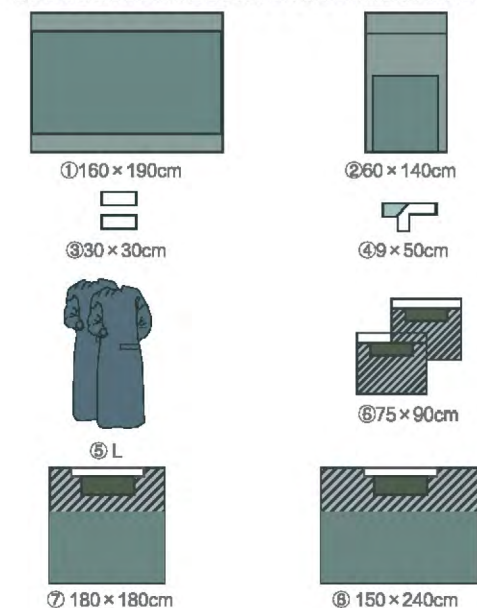

### Universal Pack with Mayo Stand Cover & Gown REF A013

No.	Product Name	Size	Quantity
1	Back Table Cover	160*190cm	1
2	Mayo Stand Cover	60*140cm	1
3	Hand Towels	30*30cm	2
4	Op-Tape	9*50cm	1
5	Standard Gowns	L	2
6	Adhesive Side Drapes	75*90cm	2
7	Adhesive Bottom Drape	180*180cm	1
8	Adhesive Top Drape	150*240CM	1

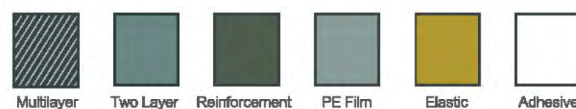

# Surgical Drapes and Packs

## GENERAL SURGERY PACKS

- Laparotomy Pack
- Laparoscopy Pack I
- Laparoscopy Pack II

P/14

### Laparotomy Pack REF A014

No.	Product Name	Size	Quantity
1	Back Table Cover	160*190cm	1
2	Mayo Stand Cover	60*140cm	1
3	Hand Towels	30*30cm	2
4	Op-Tape	9*50cm	1
5	Adhesive Utility Drapes	50*60cm	4
6	Laparotomy Drape	230*320cm	1

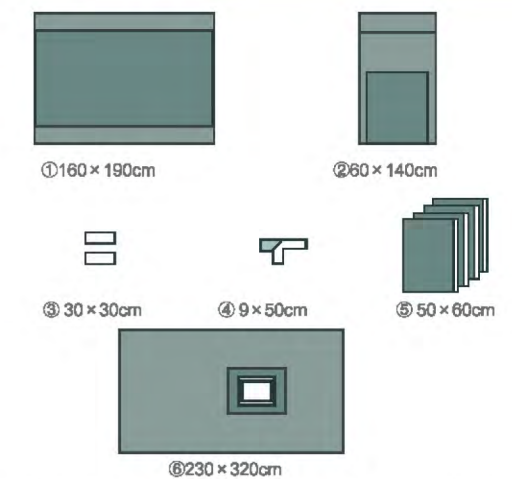

### Laparoscopy Pack I REF A015

No.	Product Name	Size	Quantity
1	Back Table Cover	160*190cm	1
2	Mayo Stand Cover	60*140cm	1
3	Suture Bag	18*28cm	1
4	Op-Tape	9*50cm	1
5	Adhesive Utility Drapes	50*60cm	4
6	Laparoscopy Drape with Hook-loop Line Holders	198*259*307cm	1

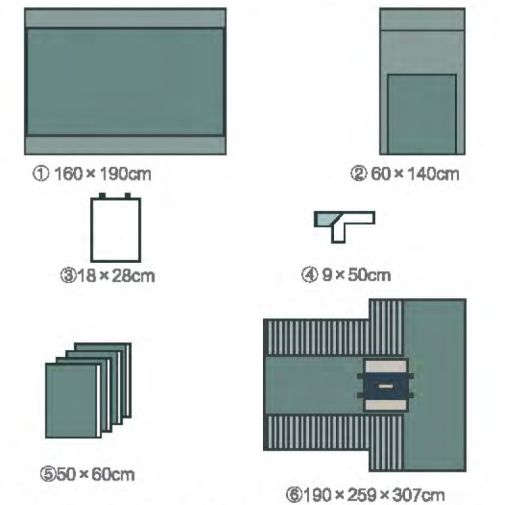

### Laparoscopy Pack II REF A016

No.	Product Name	Size	Quantity
1	Back Table Cover	160*190cm	1
2	Mayo Stand Cover	60*140cm	1
3	Suture Bag	18*28cm	1
4	Op-Tape	9*50cm	1
5	Reinforced Gowns	XL	2
6	Adhesive Utility Drapes	50*60cm	4
7	Laparoscopy Drape with 200*250*300cm Hook-loop Line Holders		1

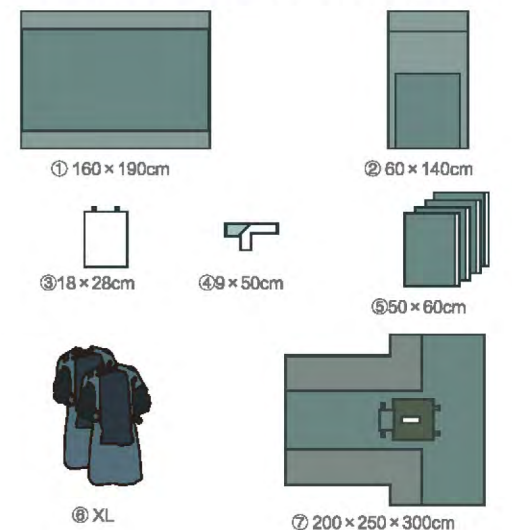



# Surgical Drapes and Packs

- Obstetrical Pack
- Delivery Pack
- Cystoscopy Pack

## UROLOGY & GYNECOLOGY PACKS

P/15

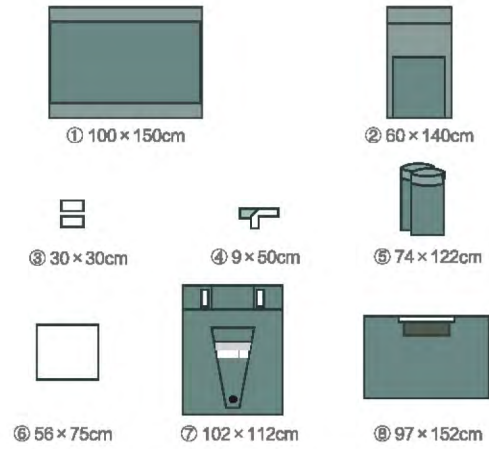

### Obstetrical Pack REF A017

No.	Product Name	Size	Quantity
1	Back Table Cover	100*150cm	1
2	Mayo Stand Cover	60*140cm	1
3	Hand Towels	30*30cm	2
4	Op-Tape	9*50cm	1
5	Leggings	74*122cm	2
6	Baby Blanket	56*75cm	1
7	Under Buttocks Drape	102*112cm	1
8	Adhesive Abdominal Drape	97*152cm	1



### Delivery Pack REF A018

No.	Product Name	Size	Quantity
1	Back Table Cover	100*150cm	1
2	Reinforced Surgical Gown	60*140cm	1
3	Towel	30*40cm	1
4	Op-Tape	9*50cm	1
5	Leggings	74*122cm	2
6	Baby Blanket	75*90cm	1
7	Under Buttocks Drape	100*112cm	1
8	Adhesive Abdominal Drape	75*90cm	1
9	Clamp		1
10	Gauzes	7.5*7.5cm	10

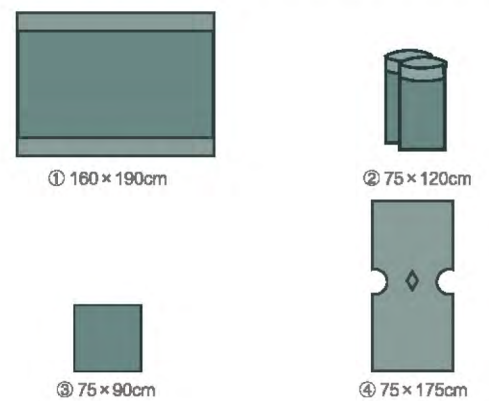

### Cystoscopy Pack REF A019

No.	Product Name	Size	Quantity
1	Back Table Cover	160*190cm	1
2	Leggings	74*120cm	2
3	Utility Drape	75*90cm	1
4	Cystoscopy	75*175cm	1

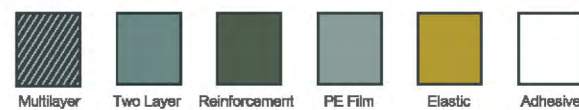

# Surgical Drapes and Packs

- Gynaecology Pack I
- Gynaecology Pack II
- Curetage Set

## UROLOGY & GYNECOLOGY PACKS

P/16

### Gynaecology Pack I REF A020

No.	Product Name	Size	Quantity
1	Back Table Cover	125*230cm	1
2	Hand Towel	30*30cm	1
3	Leggings	79*140cm	2
4	Under Buttocks Drape	96*126cm	1
5	Adhesive Abdominal Drape	98*142cm	1
6	Adhesive Utility Drape	45*50cm	1

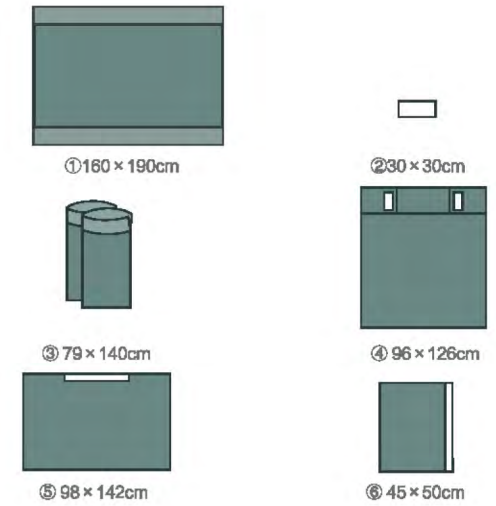

### Gynaecology Pack II REF A021

No.	Product Name	Size	Quantity
1	Back Table Cover	160*190cm	1
2	Mayo Stand Cover	60*140cm	1
3	Hand Towels	30*30cm	2
4	Tube Holder	2.5*30cm	1
5	Gynaecology Drape with Fluid Collection Pouch	60*120cm	1
6	Gynaecology Drape	270/230*260cm	1

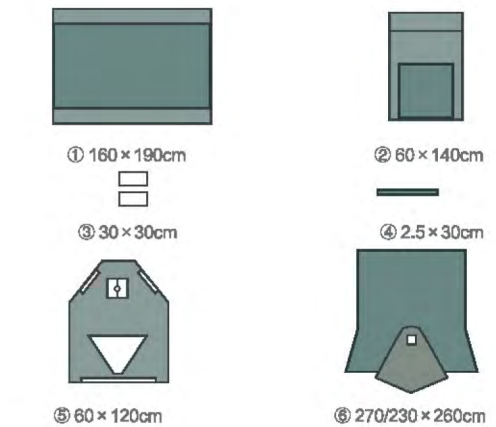

### Curetage Set REF A022

No.	Product Name	Size	Quantity
1	Back Table Cover	125*230cm	1
2	Reinforced Surgical Gown	L	2
3	Leggings	79*140cm	2
4	Under Buttocks Drape	96*126cm	1
5	Adhesive Abdominal Drape	98*142cm	1

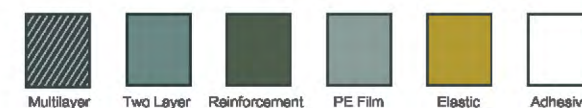
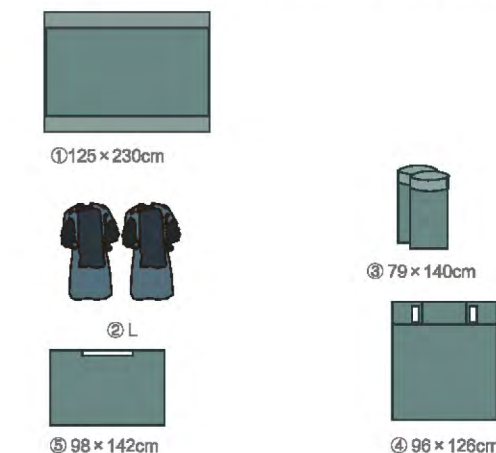

UROLOGY & GYNECOLOGY PACKS

UROLOGY & GYNECOLOGY PACKS



# Surgical Drapes and Packs

## UROLOGY & GYNECOLOGY PACKS

- Cesarean Pack I
- Cesarean Pack II
- T.U.R Pack

P/17

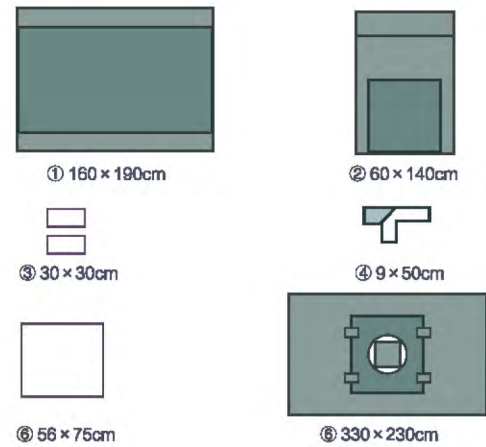

### Cesarean Pack I REF A023

No.	Product Name	Size	Quantity
1	Back Table Cover	160*190cm	1
2	Mayo Stand Cover	60*140cm	1
3	Hand Towels	30*30cm	2
4	Op-Tape	9*50cm	1
5	Leggings	74*122cm	1
6	Baby Blanket	56*75cm	1
7	Cesarean Drape I	330*230cm	1

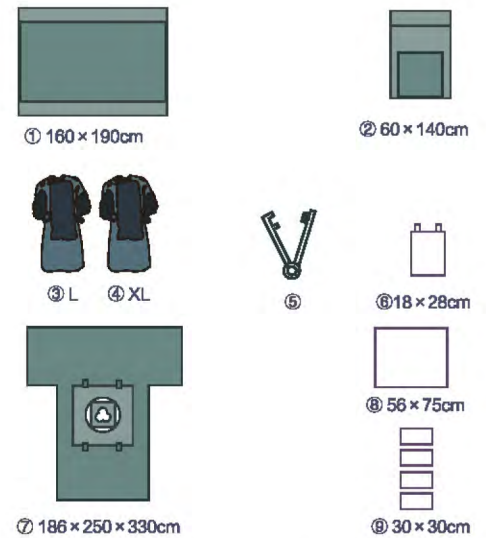

### Cesarean Pack II REF A024

No.	Product Name	Size	Quantity
1	Back Table Cover	160*190cm	1
2	Mayo Stand Cover	60*140cm	1
3	Reinforced Gown	L	1
4	Reinforced Gown	XL	1
5	Clamp		1
6	Suture Bag	L	1
7	Cesarean Drape II	186*250*330cm	1
8	Baby Blanket	56*75cm	1
9	Hand Towels	30*30cm	4

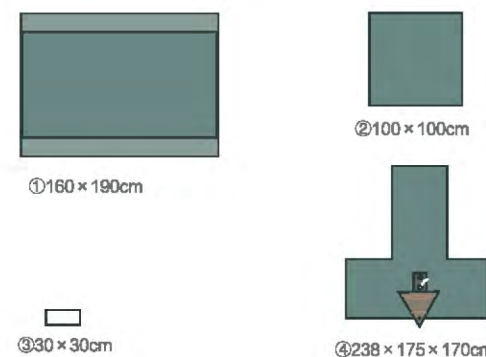

### T.U.R Pack REF A025

No.	Product Name	Size	Quantity
1	Back Table Cover	160*190cm	1
2	Sterilisation Wrap	100*100cm	1
3	Hand Towel	30*30cm	1
4	T.U.R Drape	238*175*170cm	1

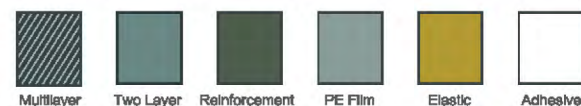

# Surgical Drapes and Packs

## CARDIOVASCULAR PACKS

- Angiography Pack I
- Angiography Pack II
- Cardiovascular Pack

P/18

### Angiography Pack I REF A026

No.	Product Name	Size	Quantity
1	Back Table Cover	160*190cm	1
2	Hand Towels	30*30cm	2
3	Absorbent Sheet	50*80cm	1
4	Adhesive Drape	50*60cm	1
5	Angiography Drape I	203*318cm	1

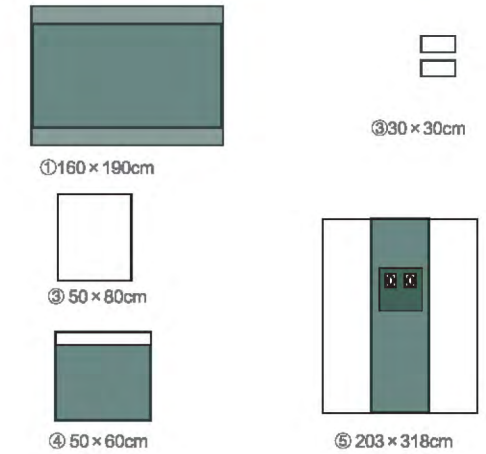

### Angiography Pack II REF A027

No.	Product Name	Size	Quantity
1	Back Table Cover	160*190cm	1
2	Hand Towels	30*30cm	2
3	Absorbent Sheet	50*80cm	1
4	Adhesive Drape	50*60cm	1
5	Angiography Drape II	200*300cm	1

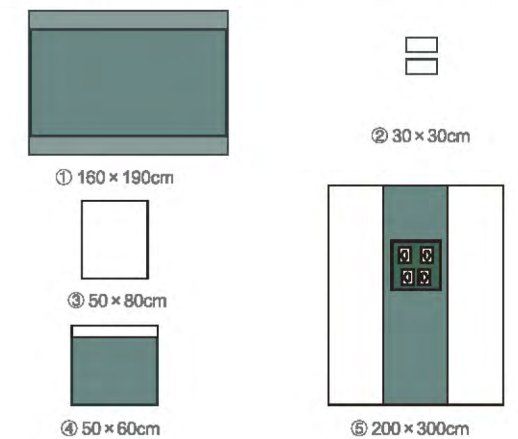

### Cardiovascular Pack REF A028

No.	Product Name	Size	Quantity
1	Back Table Cover	160*190cm	1
2	Hand Towels	30*30cm	2
3	Cardiovascular Pack	196*279*340cm	1
4	SMS Wrap	100*100cm	1

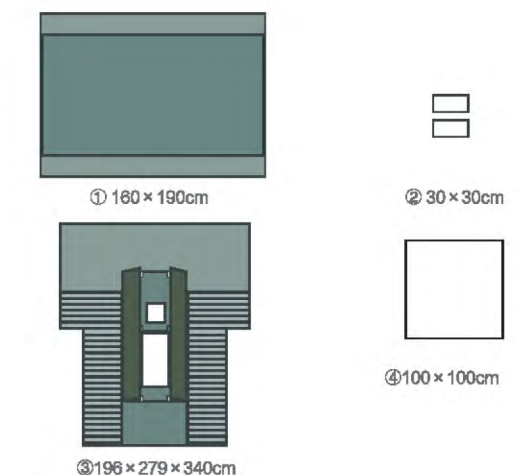
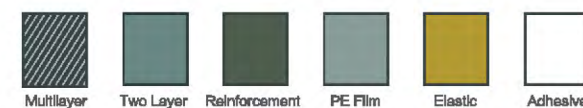

CARDIOVASCULAR PACKS

UROLOGY & GYNECOLOGY PACKS



# Surgical Drapes and Packs

- **Craniotomy Pack**
- **Spinal Pack**

## NEUROSURGERY PACKS

P/19

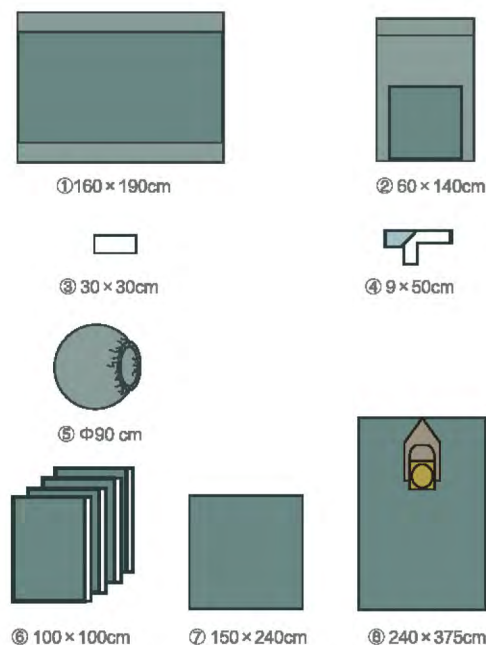

### Craniotomy Pack REF A029

No.	Product Name	Size	Quantity
1	Back Table Cover	160*190cm	1
2	Mayo Stand Cover	60*140cm	1
3	Hand Towel	30*30cm	1
4	Op-Tape	9*50cm	1
5	Banded Bag	Φ90cm	1
6	Adhesive Drape	100*100cm	4
7	Utility Drape	150*240cm	1
8	Craniotomy Drape with Pouch	240*375cm	1

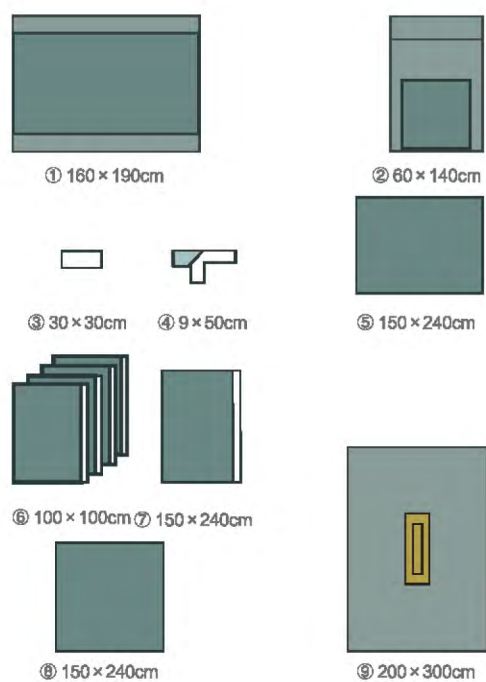

### Spinal Pack REF A030

No.	Product Name	Size	Quantity
1	Back Table Cover	160*190cm	1
2	Mayo Stand Cover	60*140cm	1
3	Hand Towel	30*30cm	1
4	Op-Tape	9*50cm	1
5	Utility Drape	150*240cm	1
6	Adhesive Drapes	100*100cm	4
7	Adhesive Drape	150*240cm	1
8	Plain Drape	150*240cm	1
9	Shunt Drape	200*300cm	1

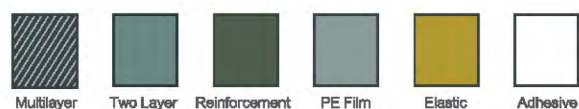

# Surgical Drapes and Packs

- **General Orthopedics Pack**
- **Hand & Foot Pack**
- **Extremity Pack**

## ORTHOPEDICS PACKS

P/20

### General Orthopedics Pack REF A031

No.	Product Name	Size	Quantity
1	Back Table Cover	160*190cm	1
2	Mayo Stand Cover	60*140cm	1
3	Hand Towels	30*30cm	4
4	Op-Tape	9*50cm	1
5	Legging	74*122cm	1
6	Adhesive Drapes	150*240cm	1
7	Adhesive Split U Drape	230*260cm	1

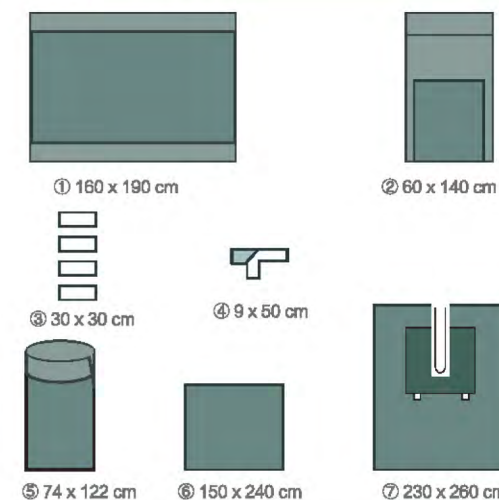

### Hand & Foot Pack REF A032

No.	Product Name	Size	Quantity
1	Back Table Cover	160*190cm	1
2	Mayo Stand Cover	60*140cm	1
3	Suture Bag	18*28cm	1
4	Op-Tape	9*50cm	1
5	Hand & Foot Drape	230*300cm	1

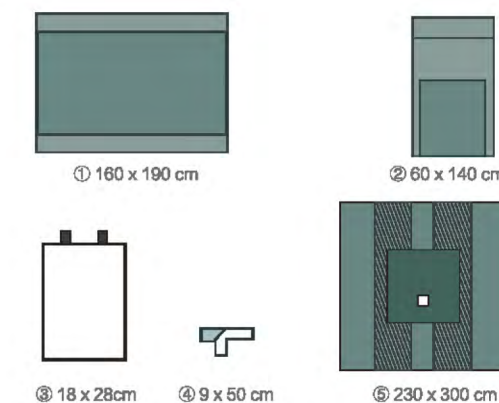

### Extremity Pack REF A033

No.	Product Name	Size	Quantity
1	Back Table Cover	160*190cm	1
2	Mayo Stand Cover	60*140cm	1
3	Suture Bag	18*28cm	1
4	Op-Tape	9*50cm	1
5	Extremity Drape	229*307*325cm	1
6	U-Drape	37*197cm	1

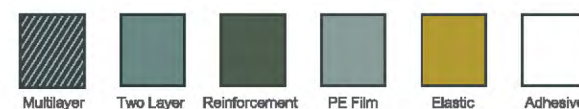
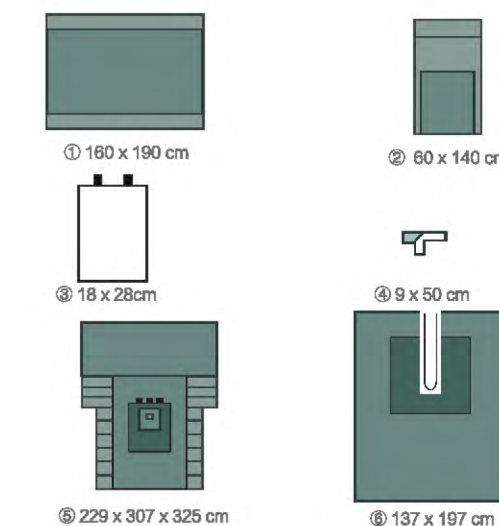

ORTHOPEDICS PACKS

NEUROSURGERY PACKS



# Surgical Drapes and Packs

## ARTHROSCOPY PACKS

- Arthroscopy Pack I
- Arthroscopy Pack II
- Shoulder Pack

P/21

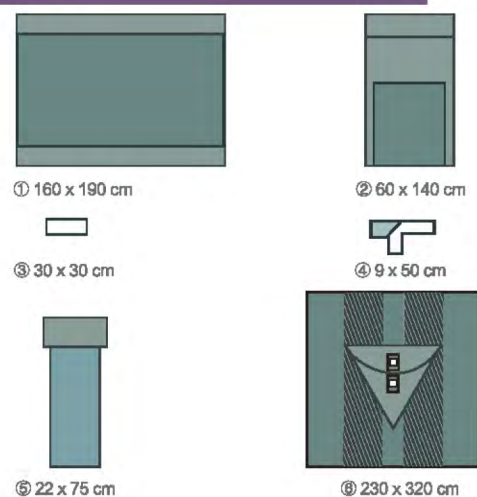

### Arthroscopy Pack I REF A034

No.	Product Name	Size	Quantity
1	Back Table Cover	160*190cm	1
2	Mayo Stand Cover	60*140cm	1
3	Hand Towel	30*30cm	1
4	Op-Tape	9*50cm	1
5	Stockinette	22*75cm	1
6	Arthroscopy Drape	230*320cm	1

### Arthroscopy Pack II REF A035

No.	Product Name	Size	Quantity
1	Back Table Cover	160*190cm	1
2	Mayo Stand Cover	60*140cm	1
3	Suture Bag	18*28cm	1
4	Op-Tape	9*50cm	1
5	Reinforced Gowns	XL	2
6	Stockinette	22*75cm	1
7	Arthroscopy Drape	229*290*310cm	1

### Shoulder Pack REF A036

No.	Product Name	Size	Quantity
1	Back Table Cover	160*190cm	1
2	Mayo Stand Cover	60*140cm	1
3	Hand Towels	30*30cm	4
4	Op-Tape	9*50cm	1
5	Stockinette	22*75cm	1
6	Elastic Bandage	15*200cm	1
7	Gauzes	10*10cm	10
8	Adhesive Drapes	75*90cm	2
9	Shoulder Drape	200*320cm	1

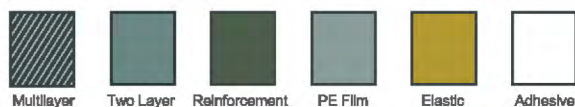
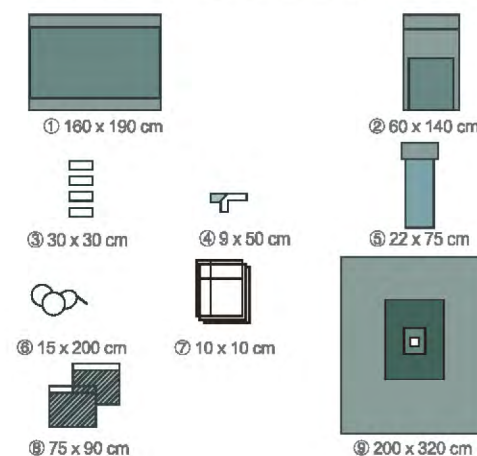
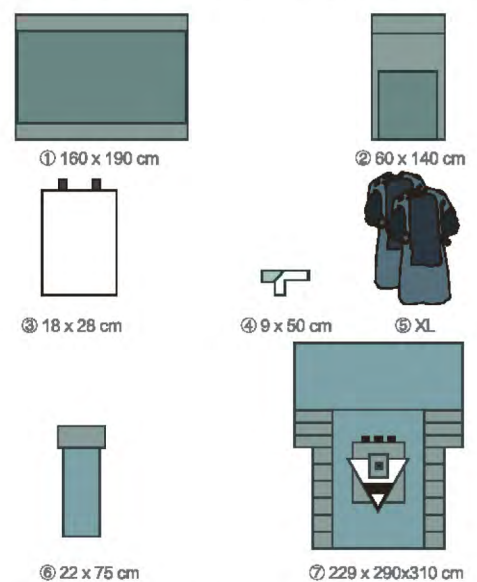

# Surgical Drapes and Packs

## HIP PACKS

- Hip Pack I
- Hip Pack II

P/22

### Hip Pack I REF A037

No.	Product Name	Size	Quantity
1	Back Table Cover	160*190cm	1
2	Mayo Stand Cover	60*140cm	1
3	Hand Towels	30*30cm	2
4	Op-Tape	9*50cm	1
5	Adhesive Drape	180*180cm	1
6	Elastic Stockinette	30*120cm	1
7	Elastic Bandage	12*6cm	1
8	Adhesive Drapes	75*90cm	2
9	Adhesive Drape	150*240cm	1
10	Adhesive Split U Drape	230*260cm	1

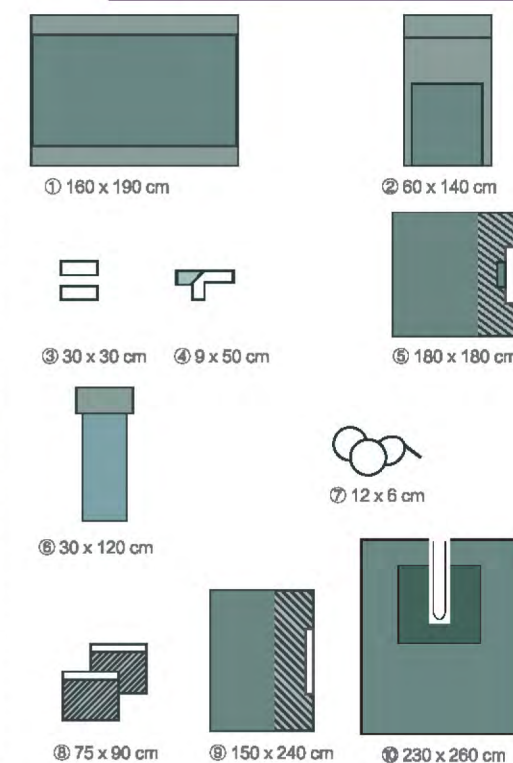

### Hip Pack II REF A038

No.	Product Name	Size	Quantity
1	Back Table Cover	160*190cm	1
2	Mayo Stand Cover	60*140cm	1
3	Suture Bag	18*28cm	1
4	Reinforced Gown	XL	1
5	Reinforced Gown with Towel & Wrap	XL	1
6	Adhesive Split U Drape	137*193cm	1
7	Elastic Stockinette	30*120cm	1
8	Hip Drape	226*325cm	1

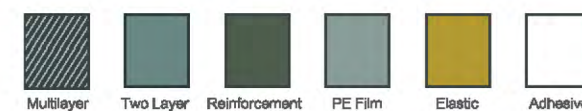
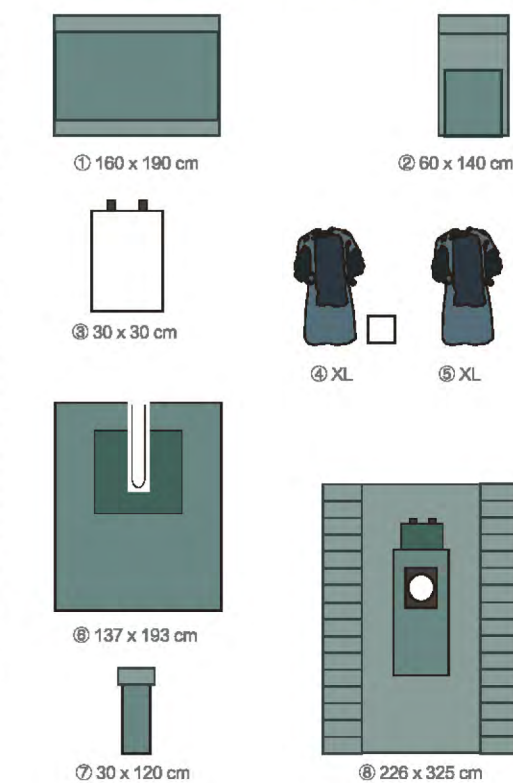



# Surgical Drapes and Packs

## OPHTHALMOLOGY PACKS

- Ophthalmic Pack I
- Ophthalmic Pack II
- Ophthalmic Pack III
- E.N.T Pack

P/23

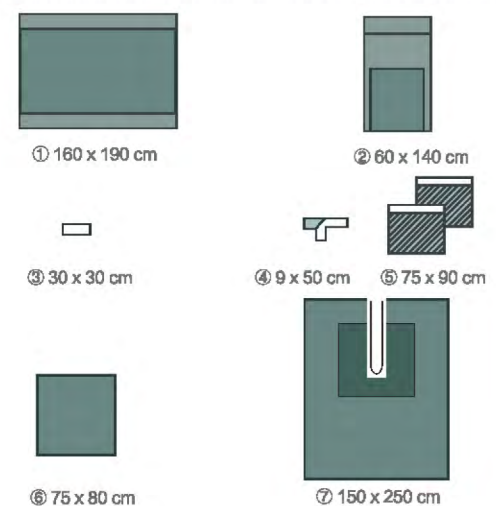
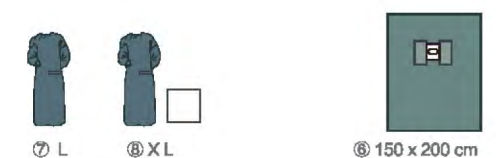
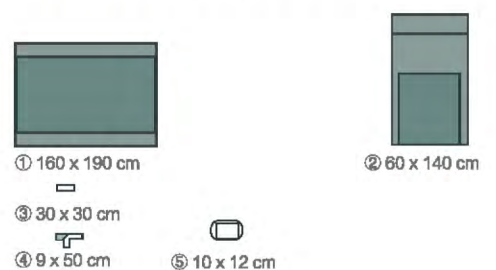
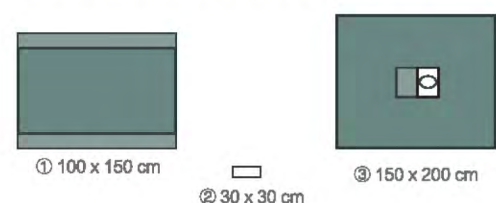
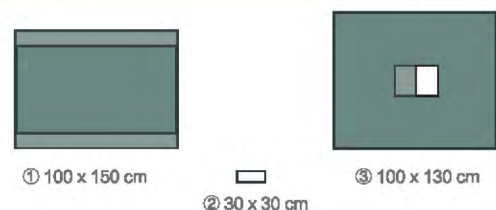

### Ophthalmic Pack I REF A039

No.	Product Name	Size	Quantity
1	Back Table Cover	100*150cm	1
2	Hand Towel	30*30cm	1
3	Ophthalmic Drape with One Pouch I	100*130cm	1

### Ophthalmic Pack II REF A040

No.	Product Name	Size	Quantity
1	Back Table Cover	100*150cm	1
2	Hand Towel	30*30cm	1
3	Ophthalmic Drape with One Pouch II	150*200cm	1

### Ophthalmic Pack III REF A041

No.	Product Name	Size	Quantity
1	Back Table Cover	160*190cm	1
2	Mayo Stand Cover	60*140cm	1
3	Hand Towel	30*30cm	1
4	Op-Tape	9*50cm	1
5	Incision Film	10*12cm	1
6	Ophthalmic Drape with Two Pouches III	150*200cm	1
7	Standard Gown	L	1
8	Standard Gown with Towel & Wrap	XL	1

### E.N.T Pack REF A042

No.	Product Name	Size	Quantity
1	Back Table Cover	160*190cm	1
2	Mayo Stand Cover	60*140cm	1
3	Hand Towel	30*30cm	1
4	Op-Tape	9*50cm	1
5	Adhesive Drapes	75*90cm	2
6	Utility Drape	75*80cm	1
7	Adhesive Spilt Drape	150*250cm	1



# Surgical Drapes and Packs

## SURGICAL DRAPES

- 2-PLY Surgical Drape
- 2-PLY Surgical Drape with Adhesive
- 2-PLY Central Fenestrated Drape
- 2-PLY Central Fenestrated Drape with Adhesive

P/24

### 2-PLY Surgical Drape

Code	Product Name	Size	Packaging
B1021	Surgical Drape	50*50cm	360pcs/case
B1022	Surgical Drape	50*70cm	320pcs/case
B1023	Surgical Drape	75*90cm	150 pcs/case
B1024	Surgical Drape	100*150cm	84 pcs/case
B1025	Surgical Drape	120*150cm	65 pcs/case
B1026	Surgical Drape	150*180cm	54 pcs/case
B1027	Surgical Drape	150*240cm	50 pcs/case

### 2-PLY Surgical Drape with Adhesive

Code	Product Name	Size	Packaging
B1121	Surgical Drape	50*50cm	360pcs/case
B1122	Surgical Drape	50*70cm	320pcs/case
B1123	Surgical Drape	75*90cm	150 pcs/case
B1124	Surgical Drape	100*150cm	84 pcs/case
B1125	Surgical Drape	120*150cm	65 pcs/case
B1126	Surgical Drape	150*180cm	54 pcs/case
B1127	Surgical Drape	150*240cm	50 pcs/case

### 2-PLY Central Fenestrated Drape

Code	Product Name	Size	Packaging
B1221	Fenestrated Drape	50*75cm(6cm*8cm)	300pcs/case
B1222	Fenestrated Drape	50*75cm(Φ7cm)	300pcs/case
B1223	Fenestrated Drape	75*90cm(6cm*8cm)	150pcs/case

### 2-PLY Central Fenestrated Drape with Adhesive

Code	Product Name	Size	Packaging
B1321	Fenestrated Drape	50*75cm(6cm*8cm)	300pcs/case
B1322	Fenestrated Drape	50*75cm(Φ7cm)	300pcs/case
B1323	Fenestrated Drape	75*90cm(6cm*8cm)	150pcs/case

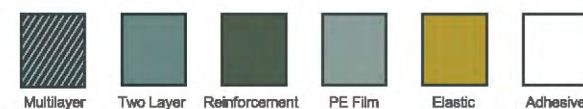



# Surgical Drapes and Packs

## U DRAPE & SPECIAL DRAPES

- U Drape with Plastic Film
- U Drape with Reinforcement
- Back Table Cover
- Mayo Stand Cover

P/25

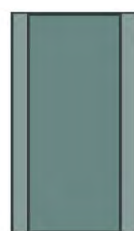
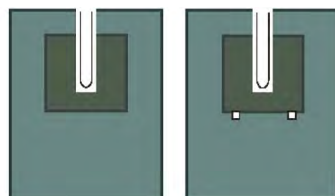
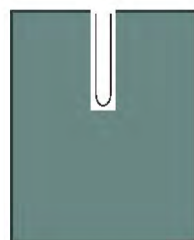

### U Drape with Plastic Film

Code	Product Name	Size	Packaging
B3010	U Drape	80*145cm	100pcs/case
B3011	U Drape	150*190cm	100pcs/case
B3012	U Drape	200*260cm	100pcs/case

### U Drape with Reinforcement

Code	Product Name	Size	Packaging
B4010	U Drape	137*193cm	100pcs/case
B4011	U Drape	200*260cm	100pcs/case
B4012	U Drape	150*250cm	100pcs/case

### Back Table Cover

Code	Product Name	Size	Packaging
C19010	Back Table Cover	150*200cm	300pcs/case
C19011	Back Table Cover	160*190cm	300pcs/case
C19012	Back Table Cover	113*220cm	150pcs/case
C19013	Back Table Cover	150*200cm	1pc/pouch,50pcs/case
C19014	Back Table Cover	160*190cm	1pc/pouch,50pcs/case
C19015	Back Table Cover	113*220cm	1pc/pouch,50pcs/case

### Mayo Stand Cover

Code	Product Name	Size	Packaging
C20010	Mayo Stand Cover	77*145cm	300pcs/case
C20011	Mayo Stand Cover	80*140cm	300pcs/case
C20012	Mayo Stand Cover	60*140cm	150pcs/case

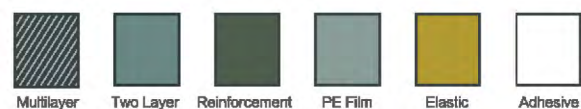

# Surgical Drapes and Packs

## GENERAL DRAPES

P/26

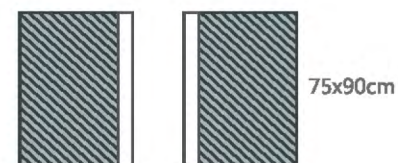

Universal Drapes

Code: D395

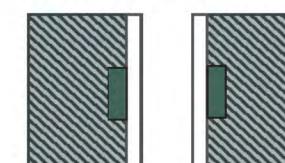

Universal Drapes with Reinforcement

Code: D396

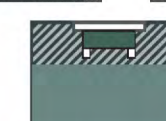

Universal Drapes with Hook-loop Line Holders

Code: D397

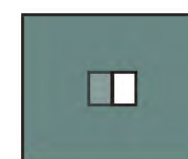

100 x 150 cm

Ophthalmic Drape I

Code: D398

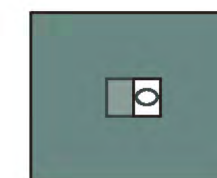

150 x 200 cm

Ophthalmic Drape II

Code: D399

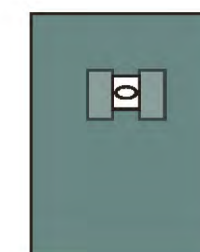

150 x 200 cm

Ophthalmic Drape III

Code: D400

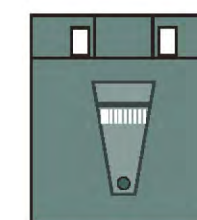

102 x 112 cm

Obstetrical Drape

Code: D401

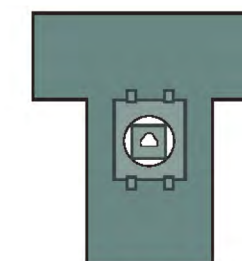

186 x 250 x 330 cm

Obstetrical Drape I

Code: D402

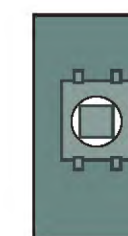

330 x 230 cm

Obstetrical Drape II

Code: D403

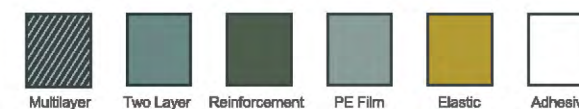

GENERAL DRAPES

U DRAPE & SPECIAL DRAPES



# Surgical Drapes and Packs

## SPECIAL DRAPES

P/27

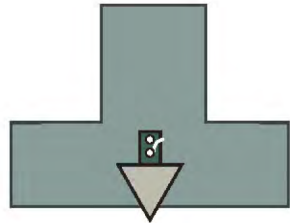

238 x 175 x 170 cm  
T.U.R Drape

Code:D404

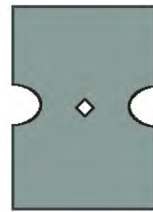

75 x 175 cm  
Cystoscopy Drape I

Code:D405

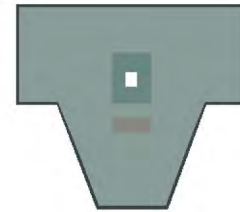

254 x 76 x 221 cm  
Cystoscopy Drape II

Code:D406

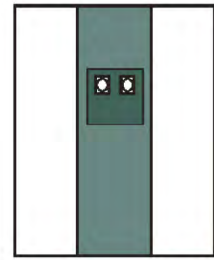

203 x 318 cm  
Angiography Drape I

Code:D407

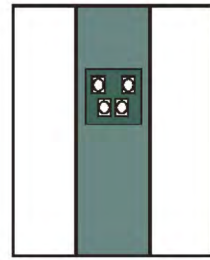

20 x 300 cm  
Angiography Drape II

Code:D408

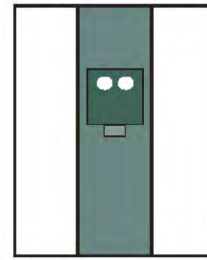

195 x 280 cm  
Angiography Drape III

Code:D409

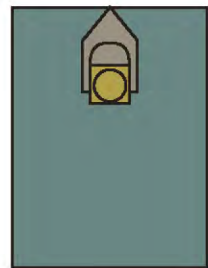

240 x 370 cm  
Craniotomy Drape

Code:D410



200 x 300 cm  
Spinal Drape

Code:D411



254 x 240 cm  
Neurological Drape

Code:D412

# Surgical Drapes and Packs

## SPECIAL DRAPES

P/28



230 x 320 cm  
Laparotomy Drape

Code: D413

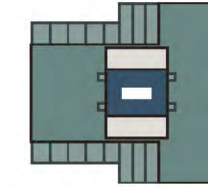

198 x 259 x 307 cm  
Laparotomy Drape I

Code: D414

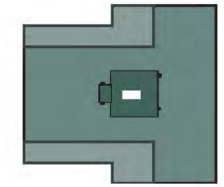

200 x 250 x 300 cm  
Laparotomy Drape II

Code: D415

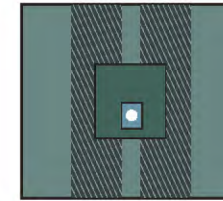

230 x 300 cm  
Hand & Foot Drape

Code: D416



230 x 300 cm  
Extremity Drape I

Code: D417

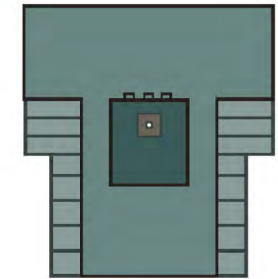

229 x 307 x 325 cm  
Extremity Drape II

Code: D418

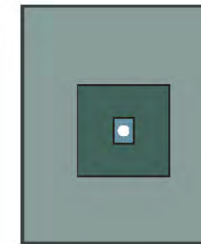

22 x 75 cm  
Shoulder Drape

Code: D419

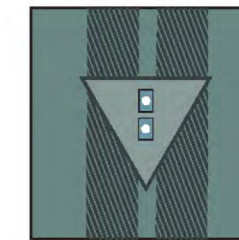

230 x 320 cm  
Arthroscopy Drape I

Code: D420

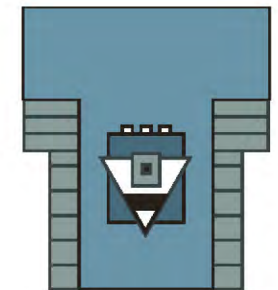

229 x 290 x 310 cm  
Arthroscopy Drape II

Code: D421



# Surgical Drapes and Packs

## OTHER COMPONENTS

P/29

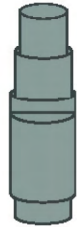

8 x 120 cm  
Tube Cover  
Code:10422

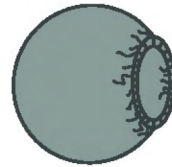

Ø90 cm  
Banded Bag  
Code:10423



75 x 120 cm  
Baby Blanket  
Code:10424



30 x 30 cm  
Hand Towels  
Code:10425



9 x 50 cm  
Op-Tape  
Code:10426

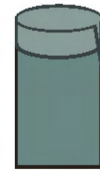

74 x 122 cm  
Legging  
Code:10427

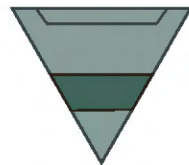

62 x 50 cm  
Fluid Collection Pouch  
Code:10428



30 x 40 cm  
Collection Adhesive Pouch  
1-chamber  
Code:10429

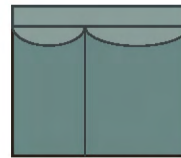

30 x 40 cm  
Collection Adhesive Pouch  
2-chamber  
Code:10430



32 x 120 cm  
Elastic Stockinette  
Code:10431

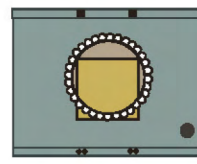

100 x 80 cm  
Incise Pouch  
Code:10432

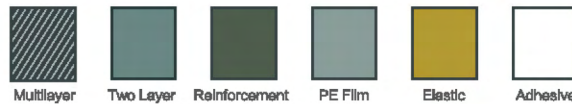

# Protective Apparels





# Protective Apparels

## Guide to Protective Materials

P/31

To eliminate confusion, here's a brief description of the main materials we use in the construction of protective apparel.

### Spunbond Polypropylene

The standard fabric for basic protective apparel; formed by bonding fibers together to form a single layer of breathable, woven-like material. Its main advantages are economy and comfort, and it also provides light fluid protection.

### Coated Polypropylene

Created when soft, spunbond polypropylene is coated with a layer of impervious polypropylene. This light weight material is ideal for any situation demanding a high level of fluid protection.

### Multi-Ply Material

A multi-ply material consisting of layers of meltblown polypropylene between layers of spunbond polypropylene. Strong, fluid-resistant and breathable, this multi-layer material provides an optimal mix of protection and comfort. Appropriate for extended wear situations involving low to moderate fluid contact.

### Breathable Laminate

Microporous film bonded to nonwoven material provides fluid proof protection and great breathability. This material is ideal for extended wear conditions where fluid contact is expected.

## Levels of barrier Protection

The Isolation Gowns with color coding neck bindings meet the test requirements set forth by Association for the Advancement of Medical Instrument (AAMI) PB70.

The chart below is set forth in the AAMI PB70 guidelines. The color coding has been developed by to differentiate each level and corresponds with the color coding neck bindings on the AAMI Compliant Isolation Gowns.

ANSI/AAMI PB70 Barrier Performance	Test Method	Test Definition	Requirement
Level 1	Water resistance: Impact Penetration AATCC 42	AATCC 42 Measures the resistance of fabrics to the liquid penetration of water by impact	Water impact $\leq 4.5g$
Level 2	Water resistance: Impact Penetration AATCC 42 Water Resistance: Hydrostatic Pressure AATCC 127	AATCC 127 Measure the resistance of fabrics to the liquid penetration of water by impact	Water impact $\leq 1.0g$ Hydrostatic pressure $\geq 20cm$
		AATCC 127 Measure the resistance of fabrics to the liquid penetration of water by impact under constant and increasing hydrostatic pressure.	
Level 3	Water resistance: Impact Penetration AATCC 42 Water Resistance: Hydrostatic Pressure AATCC 127	AATCC 127 Measure the resistance of fabrics to the liquid penetration of water by impact	Water impact $\leq 1.0g$ Hydrostatic pressure $\geq 50cm$
		AATCC 127 Measure the resistance of fabrics to the liquid penetration of water by impact under constant and increasing hydrostatic pressure.	
Level 4	Viral Penetration ASTM F1671	ASTM F1671 Measures the resistance of fabrics to blood borne pathogens using viral penetration at 2psi and ambient pressure.	Total impervious

# Protective Apparels

## AAMI APPROVED GOWNS

- Level 1 Protection
- Level 2 Protection
- Level 3 Protection
- Level 4 Protection

P/32

### Level 1 Protection

Breathable Polypropylene Maximizes Comfort in Dymex's Classic Isolation Gowns

Code	Product Name	Specification	Packaging
AAMG01	AAMI Gown	Light weight multiply material SMS 20gsm. Tape tab neck, elastic wrist	10pcs/bag, 100pcs/case



### Level 2 Protection

Dymex's Classic Yellow Medium Weight Multi-Ply Gowns are breathable, flexible and strong enough for the toughest.

Code	Product Name	Specification	Packaging
AAMG02	AAMI Gown	Medium weight multiply material SMS 25gsm. Tape tab neck, elastic wrist	10pcs/bag, 100pcs/case



### Level 3 Protection

Premium Comfortable and Breathable Multi-Ply Gowns provides high protection

Code	Product Name	Specification	Packaging
AAMG03	AAMI Gown	heavy weight multiply material SMS 35gsm. Tape tab neck, elastic wrist	10pcs/bag, 100pcs/case



### Level 4 Protection

Prevention Plus Isolation Gowns offer protection from the heaviest fluids.

Code	Product Name	Specification	Packaging
AAMG04	AAMI Gown	multiply BVB material 68gsm. Knitted cuff, hook and loop, neck closure	10pcs/bag, 100pcs/case





- Spunbonded Polypropylene Isolation Gown
- SMS Cover Gown

P/33

# Protective Apparels

## ISOLATION GOWNS



### Spunbonded Polypropylene Isolation Gown

- Light weight, fluid repellent SPP Fabric
- Generously sized for full coverage and flexibility
- Stitched Welding
- Elastic or Knitted Cuff
- Latex Free

Code	Product Name	Specification	Packaging
ISGP01-12	Isolation Gown	SPP12gsm.	10pcs/bag,100pcs/case
ISGP01-16	Isolation Gown	SPP16gsm.	10pcs/bag,100pcs/case
ISGP01-18	Isolation Gown	SPP18gsm.	10pcs/bag,100pcs/case
ISGP01-20	Isolation Gown	SPP20gsm.	10pcs/bag,100pcs/case
ISGP01-23	Isolation Gown	SPP23gsm.	10pcs/bag,100pcs/case
ISGP01-28	Isolation Gown	SPP28gsm.	10pcs/bag,100pcs/case

Note: All Dymex gowns are available in different colors and all are latex-free.

### SMS Cover Gown

- Medium weight SMS Fabric
- Abrasion-resistant
- Fluid Repellent
- One Waist Belt
- Stitched or Ultrasonic Welding
- Elastic or knitted Cuff
- Latex Free

Code	Product Name	Specification	Packaging
ISGM01-15	Isolation Gown	SMS 15gsm.	10pcs/bag,100pcs/case
ISGM01-25	Isolation Gown	SMS 25gsm.	10pcs/bag,100pcs/case
ISGM01-35	Isolation Gown	SMS 35gsm.	10pcs/bag,100pcs/case

Note: All Dymex gowns are available in different colors and all are latex-free.



# Protective Apparels

## ISOLATION GOWNS

- Impervious Isolation Gown
- Chemotherapy Gown

P/34

### Impervious Isolation Gown

- PP+PE Lamination Fabric
- Excellent Fluid Repellent
- One Waist Belt
- Stitched Sewing Or Ultrasonic Seam
- Over The Head Neck Style or Classic Style
- Knitted Cuff, Elastic Cuff Or Thumb Up
- Latex Free

Code	Product Name	Specification	Packaging
ISGIM01-35	Impervious Isolation Gown	PP+PE 35gsm.	10pcs/bag,100pcs/case
ISGIM02-40	Impervious Isolation Gown	PP+PE 40gsm.	10pcs/bag,100pcs/case
ISGIM03-45	Impervious Isolation Gown	PE 1.5MIL	15pcs/box,75pcs/case

Note: All Dymex gowns are available in different colors and all are latex-free.

### Chemotherapy Gown

- Half PP+PE Lamination
- Fluid Repellent
- Breathable
- One Waist Belt
- Stitched or Ultrasonic Welding
- Knitted Cuff
- Latex Free

Code	Product Name	Specification	Packaging
CTG01-35	Chemotherapy Gown	Half Lamination PP+PE 35gsm.	10pcs/bag, 100pcs/case
CTG02-40	Chemotherapy Gown	Half Lamination PP+PE 40gsm	10pcs/bag, 100pcs/case

### Chemotherapy Drug Tested

Prevention Plus gowns are tested against the top chemotherapy drugs.

The Prevention Plus Material has been tested against the following chemotherapy drugs per ASTM F739-99a:

- Dacarbazine
- Carmustine (BiCNU)
- Cyclophosphamide (Cytoxan)
- Doxorubicin Hydrochloride
- 5-Fluorouracil
- Cisplatin
- Etoposide (Toposar)
- Paclitaxel (Taxol)
- Thio-Tepa
- Mitomycin C
- Vincristine Sulfate

(Test data available upon request)



sonically-sealed seams provide a higher level of protection



IMPERVIOUS ISOLATION GOWN

ISOLATION GOWNS



# Protective Apparels

## ISOLATION GOWNS



### Over-the-Head Style Gowns

- PP+PE Lamination Fabric; Multiply SMS Fabric; CPE film
- Features Over-the-Head Neck Style, Open Back
- Heat Or Ultrasonic Seam
- Thumb loop wrists feature elastic for a good gown and glove fit
- Excellent Fluid Repellent
- Latex Free

Code	Product Name	Specification	Packaging
OHG01-25	Impervious Isolation Gown	SMS 25gsm.	10pcs/bag, 100pcs/case
OHG02-40	Impervious Isolation Gown	PP+PE 40gsm.	10pcs/bag, 100pcs/case
OHG03-45	Impervious Isolation Gown	PE 1.5MIL	15pcs/box, 75pcs/case

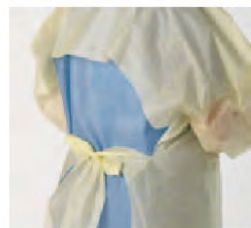

• PP+PE Lamination Fabric

• CPE film

# Protective Apparels

## OTHER APPARELS

### Scrub Suit

- SMMS Fabric with anti-static treatment
- Fluid Repellent
- Non-Transparent Complete Coverage
- Breathable
- V-Sharp or Round Shape Collar
- With Short Sleeve and Pockets
- Pants have one rear pocket, reinforced crotch area, and are available with drawstring or elastic waist
- Latex Free

Code	Product Name	Specification	Packaging
SCRB35	Scrub Suit	SMS 35gsm.	5 sets/bag or 1set/bag, 50 sets/case
SCRB40	Scrub Sult	SMS 40gsm.	5 sets/bag or 1set/bag, 50 sets/case



### Jacket

- SMMS Fabric with anti-static treatment
- Fluid Repellent
- Non-Transparent Complete Coverage
- Breathable
- V-shape or Round Shape Collar
- With Short Sleeve and Pockets
- Latex Free

Code	Product Name	Specification	Packaging
JACT35	Jacket	SMS 35gsm.	5 pcs/bag or 1pc/bag, 50 pcs/case
JACT40	Jacket	SMS 40gsm.	5 pcs/bag or 1pc/bag, 50 pcs/case





- Lab Coat
- Patient Gown

# Protective Apparels

## OTHER APPARELS

P/37



### Lab Coat

- SPP,SMS or Microporous Fabric
- Fluid resistant
- Breathable
- With Button or Zipper
- With Knitted Cuff and Pockets
- Reinforced sleeves
- Latex Free

Code	Product Name	Specification	Packaging
LBCPP30	Lab Coat	SPP30gsm.	10pcs/bag,100pcs/case
LBCSM35	Lab Coat	SMS 35gsm.	10pcs/bag,100pcs/case
LBCMCO35	Lab Coat	Microporous 35gsm.	10pcs/bag,100pcs/case



### Patient Gown

- SPP or SMS Fabric
- Non-Transparent Complete Coverage
- Breathable
- V-shape or round Shape Collar
- Without Sleeve or Short Sleeves
- Waist ties are attached
- Latex Free

Code	Product Name	Specification	Packaging
PGPP01-40	Patient Gown	SPP40gsm.	10pcs/bag,100pcs/case
PGSMS01-35	Patient Gown	SMS 35gsm.	10pcs/bag,100pcs/case

- Breathable Coveralls
- Multi-Layer Coveralls

## A WIDE SELECTION OF COVERALLS FOR EVERY SITUATION

Heavy fluids and tough jobs require a strong and protective material such as our microporous breathable material. Try our Spunbond Coveralls.

P/38

### Breathable Coveralls

- Made from microporous breathable laminate material
- Maximum protection- ideal for maternity or the OR
- Comfortable for extended periods
- Available in white

Item No.	Description	Pkg
CV3000L-XXL	Straight Wrist and Ankle	5 pcs/bag,25bags/ctn
CV3000L-XXXL	Elastic Wrist and Ankle	5 pcs/bag,25bags/ctn

### Multi-Layer Coveralls

- Made from fluid-resistant material
- Good combination of comfort and protection
- Available in white

Item No.	Description	Pkg
CV2000L-XXL	Elastic Wrist and Straight Ankle	5 pcs/bag,25bags/ctn

Need coverage for light jobs or to cover clothing?

### Standard Spunbond Coveralls

- Made from medium weight polypropylene material
- Highly breathable, fluid repellent material
- Available in white

Item No.	Size	Description	Pkg
CV1000	X-Large	Straight Wrist and Straight Ankle	5 pcs/bag,25bags/ctn
CV1000	XX-Large	Straight Wrist and Straight Ankle	5 pcs/bag,25bags/ctn

### Poly Disposable White Apron

Effective protection against liquids and waste.

.Made from polyethylene material

.Available in two lengths to protect the torso

.Convenient pullover styling for the quick and easy removal

Item No.	Size	Pkg
PA2000	41" * 62"	10pcs/bag,100pcs/ctn

Item No.	Description	Pkg
PA1001	Lightweight,24" * 42"	100cs/box,1000pcs/ctn
PA1002	Medium weight,28" * 46"	100cs/box,500pcs/ctn
PA1003	Medium weight,28" * 46"	50cs/box,250pcs/ctn
	Individually Wrapped,Dispenser Box	



### Heavyweight Blue Apron

Provides highest level of protection against fluids.

.Made from heavyweight 4 mil plastic

.Complete protection for the OR,ER,decontamination,morgue or any area where heavy fluids are present

.Styled to easily pull over the head and tie in back



# WHY MEXGUARD™ MASK

## Enhanced Safety and Performance!

### ASTM LEVEL 3

#### Meets EN 14683 Rating- Type IIR Standard

##### High Filtration, Fluid-Resistant Mask

- \*BFE=99.9% @3 microns.
- \*PFE=99.9% @0.1 micron.
- \*Patent pending design with aluminum strip under chin for custom fit.
- \*Fluid resistant outer layer
- \*White hypoallergenic inner cellulose layer
- \*Extre soft-will not link, tear or shred.
- \*Free of chemicals, inks and dyes.
- \*Extra-long aluminum nose piece



### ASTM LEVEL 2

#### Meets EN 14683 Rating- Type IIR Standard

##### Procedural Surgical Mask

- \*BFE=99.8% @3 microns.
- \*PFE=99.7% @0.1 micron.
- \*Patent pending design with aluminum strip under chin for custom fit.
- \*Fluid resistant outer layer
- \* Fluid resistant white inner layer
- \*Extra-long aluminum nose piece



### ASTM LEVEL 1

#### Meets EN 14683 Rating- Type IIR Standard

##### Isolation Face Mask

- \*BFE=98.4% @3 microns.
- \*PFE=98.5% @0.1 micron.
- \*Patent pending design with aluminum strip under chin for custom fit.
- \*Fluid resistant outer layer
- \* white tissue inner layer
- \*Extra-long aluminum nose piece



### LOW PERFORMANCE

#### Universal Face Mask

- \*BFE=95 % @3 microns.
- \*PFE=95% @0.1 micron.
- \*Patent pending design with aluminum strip under chin for custom fit.
- \*Fluid resistant outer layer
- \* white tissue inner layer
- \*Extra-long aluminum nose piece



### COMFORTABLE 3D PERFORMANCE

#### 3D Mask

- \*BFE=98.4% @3 microns.
- \*PFE=98.5% @0.1 micron.
- \*Patent pending design with aluminum strip under chin for custom fit.
- \*Fluid resistant outer layer
- \* white tissue inner layer
- \*Extra-long aluminum nose piece



MEXGUARD offers a wide variety of mask designs, fit and filtration to match the protection needs for each procedure or risk level. The MEXGUARD Mask filtration guide makes it easy to select the level of filtration required, including ASTM level 1, 2 and 3 and N95 particulate respiration. From minimum performance masks for dry, short procedures, to our maximum filtration mask, Isolator Plus, MEXGUARD has the right mask for the task!

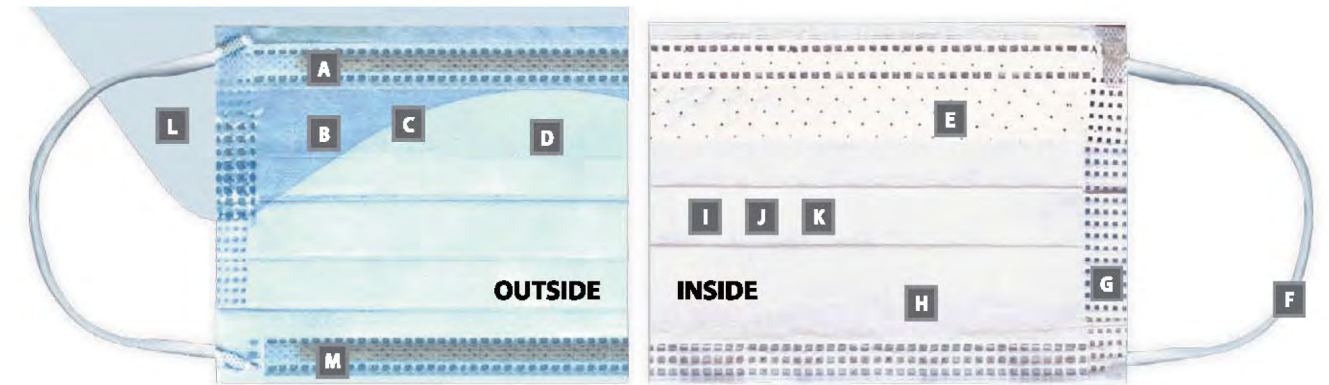

- A** Extra-long, enclosed aluminum nose piece forms a strong seal for maximum protection.
- B** Spunbond outer layer material for maximum protection against fluids.
- C** Facial tissue outer layer is ultrasoft and odorless.
- D** Vapor barrier uniquely placed on outside layer to prevent fogging.
- E** Fog Free/No-Fog strip blocks and absorbs moisture; forms a strong seal to prevent fogging; cushion nose ridge.
- F** Secure Loop earloops are soft, strong, fit comfortable, and attached to outside of mask to eliminate irritation.
- G** Soft-Bond ultrasonics ensures strongest construction, eliminating holes and defects.
- H** Highest quality filter media for best ASTM rating, filtration value and breathability.
- I** Cellulose Inner layer for sensitive skin(white, extra soft, hypoallergenic) will not lint, tear or shred; void of dyes, inks and chemicals, which can cause irritation.
- J** Tissue inner layer is made of white, soft facial tissue.
- K** Spunbond inner layer made of white, fluid-resistant material.
- L** Attached wrap-around face shield is optically clear and distortion-free.
- M** Aluminum strip under chin significantly reduces gapping at the top, sides and bottom of the mask.

## Understanding ASTM Face Mask Performance Levels

Selecting the appropriate mask for a particular procedure is a critical component of your Personal Protective Equipment (PPE) protocol. Although masks may look similar, each mask has notable differences affecting the quality and level of filtration. Understanding the ASTM performance level of each face mask can help make the selection process easier and ensure your

mask will provide the appropriate filtration. Medical face mask materials covered under ASTM specifications are designated as one or more of the following performance levels based on the barrier performance levels based on the barrier performance properties of the materials used:

	ASTM Level 1	ASTM Level 2	ASTM Level 3
FLUID RESISTANCE, mmHg	80	120	160
BFE	98%	98%	95%
PFE, @0.1micron	95%	98%	98%
DELTA P, mmH2O /cm2	4.0	5.0	5.0
FLAME SPREAD	Class 1	Class 1	Class 1

## What the terms mean:

**FLUID RESISTANCE** represents the mask's resistance to penetration by synthetic blood under pressure (mmHg). It measures the ability of a mask's material construction to minimize fluids from traveling through the material and potentially coming into contact with the wearer. The higher the fluid resistance (filtration), the better the protection.

**BFE(Bacterial Filtration Efficiency)** represents the percentage of bacteria filtered out at a spore size of 1-5 microns. It is the measure of the efficiency of the mask in filtering bacteria passing through it.

**PFE(sub-micron Particulate Filtration Efficiency)** represents the percentage of particles filtered out at a spore size of 0.1-1.0 microns. PFE is the measure of the efficiency of the mask in filtering particles passing through it. The size of the particles filtered is critical.

**DELTA P (Differential Pressure)** represents the pressure drop across the mask or resistance to air flow in mmH2O/cm2. This determines breathing resistance - the higher the Delta P, the less the breathability, but the better the filtration.

**FLAME SPREAD** measures flame spread of the mask material  
SOURCE: ASTM Standard specification for performance of materials used in medical face masks- F2100-11 Standard.  
As specified in Test Method F 1862



## HEADWEARS

### Bouffant Caps

- Choose from lightweight single-ply polypropylene or heavyweight spunbond material
- Available in solid blue, green, red and white
- Available in 21" and 24"
- All caps comply with NFPA standards



Code	Product Name	Specification	Packaging
BCP1000	Bouffant Cap	21", Blue/Green/White/Pink	100pcs/box, 300pcs/case
BCP1001	Bouffant Cap	24", Blue/Green/White/Pink	100pcs/box, 300pcs/case

### Surgeons' Cap

You're sure to find the style you need in our expanded line of surgeons' caps.

Choose from three different materials:

- SRM** – Scrim reinforced material, a paper-like absorbent material
- Multi-Layer Polypropylene** – Highly fluid-resistant, yet breathable
- Spunlace** – Extremely soft, comfortable and most absorbent



Code	Side Material	Crown Material	Color	Packaging
SCP1000	SRM	Polypropylene	Light Blue	100pcs/box, 500pcs/case
SCP1001	Multi-Layer	Polypropylene	Dark Blue	100pcs/box, 500pcs/case
SCP1002	Spunlace	Spunlace	Medium Blue	100pcs/box, 500pcs/case

### Surgeons' Hood

Complete head coverage

- Available in multi-layer material
- Ties in back of head



Code	Specification	Color	Packaging
SCP1000	Multi-Layer Material	Light Blue	100pcs/box, 500pcs/case

### Surgeons' Head and Beard Covers

- Complete head coverage
- Made of multi-layer material with an elastic neck
- Beard cover is made of spunbond polypropylene, stays in place with an elastic band
- One size fits most



Code	Specification	Color	Packaging
SCP1000	Multi-Layer Material	Light Blue	100pcs/box, 500pcs/case

## FOOTWEARS

### Non-Skid Multi-Layer Shoe Covers

- Made from breathable, fluid-resistant material
- Sport size available for larger, athletic-type shoes

Item No.	Size	Pkg
NSDSC01	Regular Size (up to men's size 12)	100/bx, 300/cs
NSDSC02	X-Large (up to men's size 15)	100/bx, 200/cs
NSDSC03	Sports Size (fits athletic shoes)	100/bx, 200/cs

### Polyethylene Shoe Covers

- Made from CPE plastic material that resists high levels of fluid
- Smooth bottom

Item No.	Size	Pkg
PESC01	One Size Fits Most	1000/cs

### Breathable Knee-High Boot Covers

- Rated number one for breathability and complete protection
- Made from Blue coated material
- Hook-and-loop closure strap allows for a snug fit
- Foam strip non-skid bottom

Item No.	Size	Pkg
BCV01	Regular Size (up to men's size 12)	50/bx, 150/cs
BCV02	X-Large (up to men's size 15)	50/bx, 150/cs

- Non-Skid Multi-Layer Shoe Covers
- Polyethylene Shoe Covers
- Breathable Knee-High Boot Covers





- Non-Skid Fluid-Proof Boot Covers
- Non-Skid Multi-Layer/Poly Knee-High Boot Covers
- Non-Skid Multi-Layer/Poly Ankle Covers

## FOOTWEARS

### Non-Skid Fluid-Proof Boot Covers

- Made from fluid-proof coated polypropylene material
- High fluid protection on the bottom
- Convenient hook-and-loop strap allows wearer to adjust the fit
- Strap is heat-sealed to boot
- Available with non-skid pattern or foam strip

Item No.	Size	Pkg
BCV03	Regular (up to men's size 12)	50/bx, 150/cs
BCV04	X-Large (up to men's size 15)	50/bx, 150/cs

### Non-Skid Multi-Layer/Poly Knee-High Boot Covers

- Breathable, fluid-resistant material above the ankle
- High fluid protection on the bottom
- Heat-sealed seams on foot reduce the chance of fluid penetration

Item No.	Size	Pkg
BCV05	Regular (up to men's size 12)	50/bx, 150/cs
BCV06	X-Large (up to men's size 15)	50/bx, 150/cs

### Non-Skid Multi-Layer/Poly Ankle Covers

- Designed for users who want full foot coverage without wearing a boot cover
- Impervious bottom with breathable material above the ankle
- Same heat-sealed seams and non-skid tread as boot cover design

Item No.	Size	Pkg
BCV07	Regular (up to men's size 12)	100/bx, 300/cs
BCV08	X-Large (up to men's size 15)	100/bx, 300/cs



## Qualification

