



# INTRODUCTION

CO.,LTD originated in 2010. We are a professional manufacturer for Medical Rehabilitation Products, Hospital Furniture and Other Medical Care Products. Our company & products are certified by ISO 9001, ISO 13485, CE, FDA etc. which products shipped to all over the world such as Europe, America, Middle East and etc.

Our main product range: Walking Aids Series(Rollator/Walker/Cane), Bathroom Safety Series(Raised Toilet Seat/ Shower Chair/Commode Chair/Obstacle-free Armrest), Electric and Manual Wheelchair Series, Electric and Manual Hospital Beds Series, Other Medical Care Products Series.

We will service for you with all sincerely, grow up together and keep constant innovation in medical health area. Let's build our dream "New thought, Health more" and draw a new blueprint of Medical Care Products and Equipments.



# INDEX

P01-20 Walking Aids Series

P49-50 Electric Wheelchair Series

P21-34 Bathroom Safety Series

P51-52 Components

P35-37 Commode Wheelchair Series

P53-62 Hospital Bed Series

P38-43 Steel Wheelchair Series

P63-84 Hospital Furniture Series

P44-48 Aluminum Wheelchair Series

P85-88 Accessories





SC1001 SC1002 SC1003 SC1001G SC1002G SC1003G SC1021 SC1022 SC1023



SC1033SA SC1035 SC1040DE SC1040DEF



**SC1001X 3-in-1 Crutches**

- ☆ Foldable walking stick crutches,
- ☆ Size: 25\*(100-154) CM
- ☆ 8 holes to adjust armrest and 9 holes to adjust footrest height



SC1031 SC1032 SC1033



SC1040S SC1040BU SC1040G SC1040R SC1040BK SC1040F

Model No.	Height(CM)	CTN SIZE(CM)	PCS/CTN	G.W. (KGS)
SC1001	134-154	140*29*32	20	20
SC1002	113-133	120*29*32	20	18.4
SC1003	84-114	100*29*32	20	16.7
SC1001G	134-154	140*29*32	20	20
SC1002G	113-133	120*29*32	20	18.4
SC1003G	84-114	100*29*32	20	18.7
SC1001X	100-154	21*10*54	1	2.5

Model No.	Height(CM)	CTN SIZE(CM)	PCS/CTN	G.W. (KGS)
SC1021	125-155	135*29*32	20	20
SC1022	94-109	120*29*32	20	18.4
SC1023	74-94	105*29*32	20	16.7
SC1031	95-126	97*30*30	20	11
SC1032	86-117	97*30*30	20	11
SC1033	104-134	97*30*30	20	13

Model No.	Height(CM)	CTN SIZE(CM)	PCS/CTN	G.W. (KGS)
SC1033SA-S	76-115	78*30*30	20	10.5
SC1033SA-M	95-126	93*30*30	20	10.5
SC1033SA-L	109-134	110*30*30	20	10.5
SC1035	75-98	100*32*32	20	10.5
SC1040DE	75-98	100*30*30	20	10.5
SC1040DEF	75-98	100*30*30	20	10.5

Model No.	Height(CM)	CTN SIZE(CM)	PCS/CTN	G.W. (KGS)
SC1040S	75-98	100*30*30	20	10.5
SC1040BU	75-98	100*30*30	20	10.5
SC1040G	75-98	100*30*30	20	10.5
SC1040R	75-98	100*30*30	20	10.5
SC1040BK	75-98	100*30*30	20	10.5
SC1040F	75-98	86*34*30	20	10.5



Model No.	Height(CM)	CTN SIZE(CM)	PCS/CTN	G.W. (KGS)
SC2001	78-100	80*19*27	20	7
SC2002	78-100	80*19*27	20	7
SC2003	78-100	80*19*27	20	7
SC2011	75-98	72*17*33	20	7
SC2012	75-98	72*17*33	20	7
SC2013	75-98	72*17*33	20	7
SC2022	80-87	66*17*29	20	7

Model No.	Height(CM)	CTN SIZE(CM)	PCS/CTN	G.W. (KGS)
SC2024	77-100	66*17*29	20	7
SC2031	67-90	66*17*29	20	7
SC2032	67-90	66*17*29	20	7
SC2033	67-90	66*17*29	20	7
SC2034	77-100	66*17*29	20	7
SC2035	67-90	66*17*29	20	7



Model No.	Height(CM)	CTN SIZE(CM)	PCS/CTN	G.W. (KGS)
SC2041	70-93	66*27*19	20	7
SC2141	70-93	66*27*19	20	7
SC2142	70-93	66*27*19	20	7
SC2501A	88	97*25*28	20	9
SC2501B	88	97*25*28	20	9
SC2501C	88	97*25*28	20	9

Model No.	Height(CM)	CTN SIZE(CM)	PCS/CTN	G.W. (KGS)
SC2502	88	97*25*28	10	6
SC2503	88	97*25*28	10	6
SC2504	88	98*23*25	15	7.5
SC32031C	70-93	66*17*29	20	7
SC3202B-N	70-99	76*29*45	10	8
SC3411B	75-97	76*29*45	10	8



SC2073



SC2074



SC2075



SC3001



SC3002



SC3003



SC3101



SC3102



SC3111



SC3112



SC3113



SC3401



SC3411



SC3011



SC3012



SC3013



SC3020



SC3021



SC3031



O-1  
ICE-O-Grip-1



O-3  
ICE-O-Grip-3



O-5  
ICE-O-Grip-5

Model No.	Height(CM)	CTN SIZE(CM)	PCS/CTN	G.W. (KGS)
SC2073	84	85*26*40	10	15
SC2074	54	90*30*45	6	10
SC2075	77-86	88*26*40	10	18
SC3001	70-94	79*23*45	10	9
SC3002	70-94	79*23*45	10	9
SC3003	70-94	79*23*45	10	9
SC3011	72-95	81*36*45	10	9
SC3012	72-95	81*36*45	10	9
SC3013	72-95	81*36*45	10	9
SC3020	73-96	76*29*45	10	9
SC3021	73-88	72*60*76	9	8
SC3030	74-97	76*29*45	10	9
SC3031	73-88	76*29*45	10	9
SC3101	70-94	79*23*45	10	7
SC3102	70-94	79*23*45	10	7
SC3111	77-99	76*29*45	10	7
SC3112	77-99	76*29*45	10	7
SC3113	77-99	76*29*45	10	7
SC3401	75-97	79*23*45	10	7
SC3411	75-97	79*23*45	10	7



SC3501

SC3511

SC3421



SW01

SW02

SW03



SC3601

SC3602

SC3431

FOLDABLE

Model No.	Height(CM)	CTN SIZE(CM)	PCS/CTN	G.W. (KGS)
SC3421	73-94	68*15*30	30	8
SC3431	73-94	68*15*30	30	8
SC3501	73-94	68*15*30	30	8
SC3511	74-96	68*15*30	30	8
SC3601	74-96	77*33*55	25	8
SC3602	74-96	77*33*55	25	8



SC4001

2-button Folding Walker



SC4001W

2-button Folding Walker W/5" wheel



SC4005

Reciprocating Folding Walker, Bronze



SC4005S

Reciprocating Folding Walker, Silver



SC4010

1-button Folding Walker



SC4010W

1-button Folding Walker W/wheel



walker can be foldable for storage & transport

Patent design for folding easily

**SC4003KD**

Red Travel Aluminum Walker



SC4015AW

**SC4015A**

Step Up Folding Walker



**SC4015B**

Step Up Folding Walker



**SC4004A**

Aluminum Heavy Duty Walker



**SC4004AW**

Aluminum Heavy Duty Walker with 5" wheels



**SC4015C**

Reciprocating Step Up Folding Walker



**SC4020A**

Rigid Walker



A 5" Swivel Wheel    C 3" Wheel Extension Leg 4" Wheel Extension Leg    D 3" Swivel Wheel    E Auto-glide Brakes, L&S    F 5" wheeled Extension Leg    G Auto-glide Brakes with 3" wheel



H Walker Platform Attachment



I Walker Skis



J Walker Glide Cap



K Glide Cap



L Walker Skis



**SC4020W**

Rigid Walker W/wheel



**SC4048**

British Folding Walker



**SC4025**  
Folding Walker W/H-bar



**SC4035A**  
Folding Walker W/seat



**SC4095A Knee Walker**

- ☆ Constructed with steel, 8" pvc wheels
- ☆ Height adjustable, PU knee pads
- ☆ Attached removable shopping bag
- ☆ Weight Capacity: 136kg (300 lbs)
- ☆ Adjustable handle height: 88.5~106cm
- ☆ Folding dimension: 41.4\*22\*75cm
- ☆ Unit weight: 9.5kg



**SC4095B Knee Walker**

- ☆ Constructed with steel, 8" pvc wheels
- ☆ Height adjustable, PU knee pads
- ☆ Attached removable basket
- ☆ Weight Capacity: 136kg (300 lbs)
- ☆ Overall width: 44cm
- ☆ Overall depth: 82.5 cm
- ☆ Adjustable handle height: 85~105.5cm
- ☆ Folding dimension: 55.5\*46\*44 cm
- ☆ Unit weight: 10.6kg



**SC4035B**  
Folding Walker W/seat



**SC4040**  
2-paddle Walker



**SC4095C Knee Walker**

- ☆ New design Knee Walker for small package size
- ☆ Constructed with steel, 8" pvc wheels
- ☆ Height adjustable, PU knee pads
- ☆ Attached removable basket
- ☆ Weight Capacity: 136kg (300 lbs)
- ☆ Overall width: 46cm
- ☆ Overall depth: 93cm
- ☆ Adjustable handle height: 81~100cm
- ☆ Folding dimension: 56\*47\*45 cm
- ☆ Unit weight: 9.4kg



**SC4075A**  
Moving Walker



**SC4075B**  
Moving Walker W/Handle

Size(cm) Model No.	SC4095A	SC4095B	SC4095C	Weight Capacity	Unit Weight
43cm	79cm	73.5*44*27cm	136kg	9.1kg	
44cm	82.5cm	55.5*46*44cm	136kg	10.6kg	
46cm	93cm	56*47*45cm	136kg	9.4kg	





**SC5000 Economic Aluminum Rollator**

- ☆ Modern Aluminum Rollator
- ☆ Conveniently for user
- ☆ Free tool, 6" wheel
- ☆ Adjustable both handle and seat height.
- ☆ Foldable for easily storage and transportation.
- ☆ Weight capacity: 350lbs=158kg
- ☆ Packing Size: 60\*18\*57 CM
- ☆ N.W 6.8KG, G.W 7.8KG



**SC5000P Push-down Rollator, 6" wheel**

- ☆ Aluminum Frame with powder-coated
- ☆ Easily push down brake system
- ☆ Height adjustable handle
- ☆ Soft foam backrest

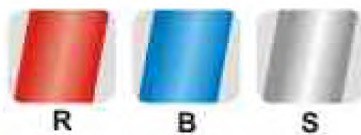

Size(cm)	Model No.	Wheel	Seat	Handle	Weight	Capacity
50cm	SC5000	6"	56cm	77cm	6.4kg	138kg
50cm	SC5000P	6"	56cm	77cm	6.4kg	136kg



**SC5023 Modern Aluminum Rollator 8" Wheels**

- ☆ 8" PVC wheels
- ☆ One touch locking lap brake system
- ☆ Mesh cloth seat
- ☆ Weight Capacity: 300lbs=136KGS
- ☆ Width:61.5cm Depth:70cm
- ☆ Seat height:55cm
- ☆ Adjustable handle height: 82-95cm
- ☆ Packing Size: 63\*46\*23cm
- ☆ N.W 6.6KG, G.W 7.6KG



**SC5023B Aluminum Rollator, New Patent**

- ☆ Patented New design, Aluminum frame.
- ☆ Die casting Tri-angle aluminum connection
- ☆ Rotatable and foldable front wheels and detachable rear legs
- ☆ 10" front wheels and 8" rear wheels
- ☆ Convenient Button to adjust handle height
- ☆ Foam padded nylon seat with pull up strap and easily folding
- ☆ Weight Capacity: 300lbs=136KGS
- ☆ Width: 64 cm Depth:69cm
- ☆ Seat height:54cm
- ☆ Adjustable handle height: 79.5-92cm
- ☆ Packing Size: 55\*44\*21cm
- ☆ N.W 8KG, G.W 9KG



Size(cm)	Model No.	Wheel	Seat	Handle	Weight	Capacity
50cm	SC5023	8"	55cm	82-95cm	6.6kg	136kg
50cm	SC5023B	8"	54cm	79.5-92cm	8kg	136kg



**SC5025A Modern Aluminum Rollator**

- ☆ 8" PVC wheels
- ☆ One touch locking top brake system
- ☆ Mesh cloth seat
- ☆ Weight Capacity: 300lbs=136KGS
- ☆ Width:62cm Depth:67cm
- ☆ Seat height:54cm
- ☆ Adjustable handle height: 79-92cm
- ☆ Folding dimension:62\*36\*27.5cm
- ☆ Packing Size: 66\*31\*37 cm
- ☆ N.W 7.9KG G.W 8.9KG



**SC5025B Modern Aluminum Rollator**

- ☆ 8" EVA wheels
- ☆ Attached removable shopping bag
- ☆ Mesh cloth seat
- ☆ Weight Capacity: 136KGS=300lbs
- ☆ Width:63cm Depth:68cm
- ☆ Seat height:50cm
- ☆ Adjustable handle height: 80-92cm
- ☆ Folding dimension:30\*71\*84cm 8" PVC wheels



**SC5025A-N Modern Aluminum Rollator**

- ☆ 8" PVC wheels
- ☆ One touch locking top brake system
- ☆ Mesh cloth seat
- ☆ Weight Capacity: 300lbs=136KGS
- ☆ Width:62cm Depth:67cm
- ☆ Seat height:54cm
- ☆ Adjustable handle height: 79-92cm
- ☆ Folding dimension:62\*36\*27.5cm
- ☆ Packing Size: 66\*31\*37 cm
- ☆ N.W 7.9KG G.W 8.9KG



**SC5025C Transport Wheelchair & Rollator**

- ☆ Attractive 2-in-1 Euro Style, light weight Aluminum Frame
- ☆ Removable footrest transform wheelchair into rollator
- ☆ Backrest can be turn in the front or behind
- ☆ One touch locking loop brake system
- ☆ Attached removable shopping bag
- ☆ Mesh cloth seat
- ☆ Overall width :64cm
- ☆ Overall depth :105cm
- ☆ Seat height:55cm
- ☆ Adjustable handle height:84~97cm
- ☆ Folding dimension:66\*31\*47cm
- ☆ Weight Capacity: 136kg(300 lbs)
- ☆ N.W 8.9KG G.W 9.9KG

Size(cm)	Rollator	Rollator	Rollator	Rollator	Rollator	Rollator
Model No.:	Rollator	Rollator	Rollator	Rollator	Rollator	Rollator
SC5025A	50cm	71cm	69cm	66*31*37cm	136kg	7.9kg
SC5025A-N	50cm	66cm	73cm	66*31*37cm	136kg	8.5kg

Size(cm)	Rollator	Rollator	Rollator	Rollator	Rollator	Rollator
Model No.:	Rollator	Rollator	Rollator	Rollator	Rollator	Rollator
SC5025B	50cm	64cm	105cm	66*31*47cm	136kg	8.5kg
SC5025C	50cm	64cm	105cm	66*31*47cm	136kg	8.9kg



**SC5029 Full-length Brake Rollator**

- ★ Full length brake handle suitable for one hand operations
- ★ Including a tray and textile bag
- ★ Lightweight aluminum frame
- ★ KD wheels make a very small packing
- ★ Front wheel 6", Rear wheel 8"
- ★ Packing Size: 62\*51\*20cm
- ★ Weight Capacity: 100KG(250 lbs)
- ★ N.W 6.2KG G.W 7.2KG



**SC5037B Forearm Rollator with Ergonomic Arm Pad**

- ★ Forearm Rollator with Ergonomic Arm Pad
- ★ Armrest can be adjustable in 6 level, with brake handles
- ★ High Quality padded forearm, 8" PVC wheels
- ★ Mesh cloth seat with pull up strap and easily side- to- side folding
- ★ Cane holder and shopping bag attached
- ★ Weight Capacity: 300lbs=136KGS
- ★ Width:61.5cm Depth:70cm
- ★ Seat height:54cm
- ★ Adjustable handle height: 108.5-121cm
- ★ Packing Size: 73x28x80cm
- ★ N.W 7.4KG G.W 8.4KG



Size(cm)	Model No.	Icon 1	Icon 2	Icon 3	Icon 4	Icon 5
61cm	SC5029	Icon 1	Icon 2	Icon 3	Icon 4	Icon 5
50cm	SC5037B	Icon 1	Icon 2	Icon 3	Icon 4	Icon 5



**SC5060A 2-wheel Rollator with Seat, Steel**

- ★ Steel frame, padded seat, easy folding
- ★ Great for indoor and outdoor use
- ★ 4" EVA wheels
- ★ Packing Size: 68x16x55cm
- ★ N.W 4.8KGS G.W 5.8KGS



**SC5060B Double-2 Wheels Rollator with Seat, Aluminum**

- ★ Aluminum frame, plastic seat, easy folding
- ★ Height adjustable and with double 5" wheels
- ★ Packing Size: 59\*21\*86cm, 2pcs/ctn
- ★ N.W 5KGS G.W 12KGS



**SC5060B-P 2-wheel Rollator with seat, Aluminum**

- ★ Aluminum Frame with powder-coated
- ★ Height adjustable with 6" castor\*2
- ★ Soft foam backrest
- ★ Color optional: Red, Blue, Orange, Dark Grey

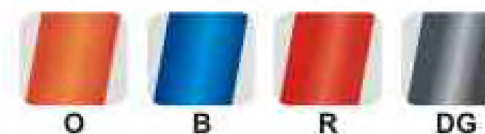

**SC5060C Double-2 Wheels Rollator with Auto-glide Brake**

- ★ Aluminum frame, plastic seat, easy folding
- ★ Height adjustable, with double 5" front wheels and Auto-glide brake 3" wheels
- ★ Packing Size: 59\*21\*88cm, 2pcs/ctn
- ★ N.W 5.5KGS G.W 13KGS

Size(cm)	Model No.	Icon 1	Icon 2	Icon 3	Icon 4	Icon 5
51cm	SC5060A	Icon 1	Icon 2	Icon 3	Icon 4	Icon 5
57cm	SC5060B	Icon 1	Icon 2	Icon 3	Icon 4	Icon 5
43cm	SC5060B-P	Icon 1	Icon 2	Icon 3	Icon 4	Icon 5
57cm	SC5060C	Icon 1	Icon 2	Icon 3	Icon 4	Icon 5



**SC5001 Aluminum Rollator, 6" wheel**

- ☆ Lightweight frame with liquid-coating;
- ☆ Easily fold for good storage and transport
- ☆ Easy squeeze and release hand brake system;
- ☆ PVC padded Seat;
- ☆ Detachable backrest saved space
- ☆ 8" high quality solid castors
- ☆ Colors available in Blue, Green, Burgundy, Champagne & Titanium
- Optional: Shopping Bag



DETACHABLE



STEPPER

**SC5010 Stepper Rollator**

- ☆ Lightweight frame with liquid-coating;
- ☆ Easily fold for good storage and transport
- ☆ Easy squeeze and release hand brake system;
- ☆ PVC padded Seat;
- ☆ Detachable backrest saved space
- ☆ Foldable Footrest for easy step on or off.
- ☆ 8" high quality solid castors
- ☆ Colors available in Blue, Green, Burgundy, Champagne & Titanium
- Optional: Shopping Bag



**SC5031A Steel Rollator**



**SC5031C Steel Rollator**



**SC5041A Steel Delta Rollator**



**SC5041C Steel Delta Rollator**



**SC5011B Aluminum Rollator, 8" wheel**

- ☆ Lightweight frame with liquid-coating;
- ☆ Easily fold for good storage and transport
- ☆ Easy squeeze and release hand brake system;
- ☆ PVC padded Seat;
- ☆ Detachable backrest saved space
- ☆ 8" high quality solid castors
- ☆ Colors available in Blue, Green, Burgundy, Champagne & Titanium
- Optional: Shopping Bag



Push-down Brakes

**SC5021A Push down brakes Rollator with 5" castor**

- ☆ Lightweight frame with liquid-coating;
- ☆ Easily push down brake system
- ☆ PVC padded seat
- ☆ Adjustable handle to meet the requested height;
- ☆ Detachable backrest saved space
- ☆ 5" high quality solid castors (6" wheels optional)
- ☆ Colors available in Blue, Green, Burgundy, Champagne & Titanium
- Optional: Shopping Bag



**SC5041D Steel Delta Rollator**



**SC5041E Aluminum Delta Rollator**

Size(cm)	Icon 1	Icon 2	Icon 3	Icon 4	Icon 5	Icon 6
Model No.	Icon 1	Icon 2	Icon 3	Icon 4	Icon 5	Icon 6
SC5001	48cm	61cm	54cm	63*23*85cm	136kg	6.7kg
SC5010	48cm	61cm	93cm	61*23*85cm	136kg	8.4kg
SC5011B	48cm	61cm	54cm	63*23*85cm	136kg	8kg
SC5021A	44cm	61cm	61cm	63*23*85cm	136kg	8.7kg

Size(cm)	Icon 1	Icon 2	Icon 3	Icon 4	Icon 5	Icon 6
Model No.	Icon 1	Icon 2	Icon 3	Icon 4	Icon 5	Icon 6
SC5031A	45cm	60cm	72cm	59*27*71.5cm	136kg	10.5kg
SC5031C	45cm	60cm	72cm	59*27*71.5cm	136kg	12.4kg
SC5041A	45cm	64cm	57cm	2pcs/68*30*70cm	136kg	16.5kg
SC5041C	45cm	64cm	57cm	2pcs/68*30*70cm	136kg	18.5kg
SC5041D	45cm	64cm	57cm	2pcs/68*30*70cm	136kg	16.5kg
SC5041E	45cm	64cm	57cm	2pcs/68*30*70cm	136kg	15.1kg

- ☆ High density PE back and seat
- ☆ Durable aluminum frame against corrosion
- ☆ Suction Rubber tips and Angles legs divided weight over a large area to increase patient security
- ☆ Quick release backrest with 3 adjustable position



**SC6001Q**  
Bath Bench W/O back



**SC6001QO**  
Bath Bench Quick-release



**SC6001Q-KDO**  
New and Popular Chair



**SC6005Q**  
Shower chair W/Back



**SC6005QO**  
Shower chair, Tool-free



SC6005Q-KD



**SC6010Q**  
Bath Bench with EVA pad



**SC6011-KDO**  
U-shape Bath Bench W/O back



**SC6015AQ**  
U-shape Bath Bench W/Back



**SC6015C-KDO**  
U-shape Bath Bench W/Back, knock-down design

Size(cm) Model No.:	Icons							PCS	DIM	(Kg)	KG	Loading Capacity	
	20FT	40HQ	20FT	40HQ									
SC6001	49	49	30	-	39	39-49	39-49	4	60*38*41	100	1.7/8.8	1280	3080
SC6001Q	50	50	30	-	44	39-57	35-53	4	57*44*47	100	1.8/9.2	960	2320
SC6001Q-KD	50	50	30	-	44	39-57	35-53	4	57*44*47	100	1.8/9.2	960	2320
SC6005	49	49	30	35	51	69-86	35-52	4	60*38*41	100	3.1/14.4	1280	3080
SC6005Q	50	50	30	35	49	71-89	35-53	4	64*52*53	100	2.9/13.6	640	1540
SC6010	49	39	30	39	51	73-83	35-45	2	69*20*40	100	4.3/1.7	1020	2460
SC6011-KD	49	49	33	-	58	36-54	36-54	5	82*35*62	100	1.8/10.0	790	1910
SC6015A	49	49	33	38	58	71-89	36-54	5	82*35*62	100	2.8/16.0	790	1910
SC6015C-KD	49	49	33	38	58	71-89	36-54	5	82*35*62	100	2.8/16.0	790	1910



**SC6020A**  
Bath Stool, Injection board



**SC6020B**  
Bath Stool, Blow-type board



**SC6020C**  
Bath Stool, Bamboo



**SC6020D Swivel bath seat**  
☆ Aluminum frame  
☆ 360 degree swivel seat  
☆ Easy disassembly



**SC6020E**  
Bath Stool with EVA pad



**SC6025A**  
Foldable Bath Bench, Steel



**SC6025B**  
Foldable Bath Bench, Aluminum

Size(cm) Model No.:	Icons							PCS	DIM	(Kg)	KG	Loading Capacity	
	20FT	40HQ	20FT	40HQ									
SC6020A	32	32	32	-	32	35-53	35-53	6	49*39*42	100	1.22/9.32	2100	5100
SC6020B	32	32	32	-	32	38-55	38-55	2	36*36*40	100	1.54/2.0	1080	2620
SC6020C	58	58	58	-	58	34-47	34-47	1	59*42*11	100	3.0/4.0	1030	2500
SC6020D	32	32	32	-	32	38-55	38-55	2	36*36*40	100	1.54/2.0	1080	2620
SC6020E	32	32	32	-	32	38-55	38-55	2	36*36*40	100	1.54/2.0	1080	2620
SC6025A	49	49	30	-	38	52	48	2	55*54*26	100	3.1/7.1	726	1760
SC6025B	51	50	31	-	43-49	48-51	48-51	1	52*39*10	100	2.4/3.0	1380	3350



**SC6030A**   
Transfer Bath Bench



**SC6030A-KD**   
KD Transfer Bath Bench



**SC6040B**   
Bath Chair, Stainless Steel



**SC6040C**   
Swivel Bath Chair Stainless Steel



**SC6030B**   
Transfer Bath Bench W/Back



**SC6030B-KD**   
Transfer Bath Bench W/ Rubber Suction



**SC6045A**   
★ Length: 730mm  
★ Width: 230mm  
★ Depth: 230mm



**SC6045B Bathtub Seat, KD design**   
★ Length: 730mm  
★ Width: 230mm  
★ Depth: 230mm



**SC6030C**   
Padded Transfer Bench W/Commode



**SC6030D**   
Padded Transfer Bath Bench



**SC6045C Bath Board**   
★ Fixed location adjustable from 40-65cm  
★ PP material  
★ Width: 320mm  
★ Depth: 190mm  
★ Weight Capacity: 110KG



**SC6045C-N Bath Board W/O Swivel Seat**   
**SC6045D Bath Board W/Swivel Seat**   
★ With detachable Swivel board  
★ Fixed location adjustable from 46-68cm  
★ PP Material, with soft handgrip  
★ Size: 76\*35.5\*9.5 cm  
★ Weight Capacity: 110KG

Size(cm) Model No.							PCS	DIM		KG	Loading Capacity		
	20FT	40HQ											
SC6030A	77	70	41	39	53	81-91	43-53	2	80*22*45	100	4.7/10.4	690	1680
SC6030A-KD	77	70	41	39	53	81-91	43-53	2	80*22*45	100	4.7/10.4	690	1680
SC6030B	81	70	41	35	55	81-91	46-56	2	82*46*48	100	4.4/9.8	320	800
SC6030B-KD	81	70	41	35	55	81-91	46-56	2	82*46*48	100	4.4/9.8	320	800
SC6030C	68	62	41	39	49	84-94	46-56	1	64*41*42	100	5.7/6.0	254	620
SC6030D	64	51	42	38	64	84-94	46-56	2	70*45*52	100	13/15	340	830

Size(cm) Model No.							PCS	DIM		KG	Loading Capacity		
	20FT	40HQ											
SC6040B	55	50	37	37	-	-	39-49	2	72*60*58	100	4.3/5.3	220	562
SC6040C	73	50	37	37	52	-	-	2	72*56*38	100	4.3/9.6	366	880
SC6045A	73	23	23	-	-	18	-	5	84*28*41	100	1.5/9.0	1560	3800
SC6045B	73	23	23	-	-	18	-	5	84*28*41	100	1.5/9.0	1560	3800
SC6045C-N	36	36	10	-	75	19	-	4	79*24*38	100	2.3/10.2	1554	3775
SC6045D	36	36	10	-	75	25	-	6	79*36*38	100	2.7/11.8	1554	3775



**SC6050-1 Foot Stool, Knock-down design**

- ☆ PE seat, TPR rubber tips
- ☆ Knock-down design
- ☆ Height adjustable in 3 levels
- ☆ Weight Capacity: 180KG(400lbs)



**SC6055A-N**

Armrest Shower Chair

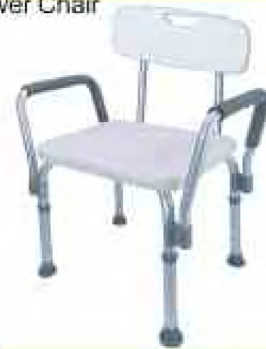

**SC6055B-N**

Armrest Shower Chair W/Back



**SC6050-2**

Bath Footstool with 2 Step



**SC6055A-KD**

Armrest Shower Chair, KD design



**SC6055B-KD Armrest Shower Chair W/Back, KD design**

- ☆ Tool-free Backrest and Armrest
- ☆ PE seat and back
- ☆ Aluminum frame
- ☆ Suction Rubber tips

**SC6190A Wall-mounted Shower Chair**

- ☆ New-design to save space
- ☆ Seat Width: 500mm
- ☆ Seat Depth: 310mm
- ☆ Height adjustable from 380-530mm

Size(cm) Model No.:	Icons						PCS	DIM	(Kg)	KG	Loading Capacity		
	20FT	40HQ	20FT	40HQ									
SC6050-1	48	42	23	-	32	20-25	20-25	1	42*24*11	150	1.5/2.5	2525	6132
SC6050-2	47	42	56	-	48	16-32	16-32	1	49*13*33	100	2.5/6	1332	3234
SC6055A-N	52	40	33	-	34	58-71	42-55	1	59*17*38	100	2.0/3.0	734	1784
SC6055A-KD	52	40	33	-	34	58-71	42-55	1	43*16*35	100	2.0/3.0	1162	2823
SC6055B-N	52	40	33	33	48	64-77	42-55	1	59*17*38	100	2.5/3.5	734	1784
SC6055B-KD	52	40	33	33	48	64-77	42-55	1	43*16*35	100	2.5/3.5	1162	2823
SC6190A	42	38	-	-	38	40-50	40-50	1	52*17*44	100	8.1/9	719	1748

- ☆ Size available in 12", 16", 18", 24" and 32"
- ☆ Material available steel, stainless steel, aluminum and ABS



**SC6065**  
Steel Grab Bar, Enamel-coated



**SC6075**  
Steel Grab Bar, Knurled, Chrome



**SC6085**  
Stainless Steel Grab Bar, High-gloss Polish



**SC6095**  
Plastic Grab Bar (ABS flanges and PVC tubing)



**SC6285**  
Stainless Steel Grab Bar, Sands Polish



**SC6060 Bathtub Bar**  
 ☆ 1" Steel bar provides reliable patient assistance into or out of the Bathtub  
 ☆ Locking device attached to tub wall up to 178mm wide  
 ☆ Width: 152mm  
 ☆ Height: 355mm



**SC6165**  
Grab Bar, Aluminum



**SC6385**  
Stainless Steel Grab Bar, Brushed Polish



**SC7001**  
Commode Chair, Foldable



**SC7001W**  
Commode Chair W/castor



**SC7001L**  
Commode Chair, Aluminum



**SC7001LW**  
Commode Chair W/Castor, Aluminum



**SC7001FA Foldable Commode Chair, Aluminum**  
★ With 2 in 1 commode pot  
★ Size:W52\*D43\*H59-73cm



**SC7001FP**  
Foldable Commode Chair, Steel

Size(cm) Model No.	Icons								PCS	DIM	(Kg)	NW GW	Loading Capacity		
	20FT	40HQ	20FT	40HQ											
SC7001	55	46	40	8	8	35	51	74-84	41-51	1	53*21*77	100	6.5/8.3	326	792
SC7001W	55	46	40	-	-	31	49	70-77	37-47	1	53*21*77	100	5.2/7.0	326	792
SC7001L	55	46	40	8	8	35	51	74-84	41-51	1	53*21*77	100	4.2/6.6	326	792
SC7001LW	55	46	40	-	-	31	49	70-77	37-47	1	53*21*77	100	5.2/7.0	326	792
SC7001FA	56	34	-	-	-	22	46	62-77	40-55	2	56*33*67	100	2.8/6	450	1090
SC7001FP	56	34	-	-	-	22	46	62-77	40-55	2	56*33*67	100	3.2/7	450	1090



**SC7005A**  
Commode Chair W/Footplate



**SC7005B**  
Commode Chair W/Footstep, Aluminum



**SC7005C-KD Commode Chair W/Wheels, Steel**

- ★ Wheeled commode with padded seat, Powder-coating frame
- ★ Screws back, plastic armrests and 4" wheels
- ★ Bucket and lid included
- ★ Overall Dimensions: 90\*52cm
- ★ Product Weight: 52cm
- ★ Weight Capacity: 110KG(250lbs)



**SC7010**  
Commode Chair W/Drop-down Armrest



**SC7010W**  
Commode Chair W/Drop-down Armrest and Wheels



**SC7020**  
Commode Chair W/soft seat

Size(cm) Model No.	Icons								PCS	DIM	(Kg)	NW GW	Loading Capacity		
	20FT	40HQ	20FT	40HQ											
SC7005A	54	44	43	10	10	33	74	83	47	1	53*26*73	100	10.2/12.0	278	676
SC7005B	56	45	52	8	10	36	84	89	46	1	56*51*115	100	8.2/10.0	654	1587
SC7005C-KD	54	40	52	10	10	32	52	82	54	1	58*17*75	100	7.5/9	400	970
SC7010	57	49	40	-	-	28	51	62-72	37-47	1	56*38*39	100	6.2/8.0	338	820
SC7010W	57	49	40	8	8	28	51	70-80	45-53	1	56*40*36	100	6.5/8.5	338	820
SC7020	54	44	44	-	-	34	44	85	47	1	53*21*76	100	7.9/9.7	330	800





**SC7030** ◀  
Extra-wide Commode Chair

**SC7040** ◀  
3-in-one Commode Chair

**SC7040L** ◀  
Commode Chair W/back, Aluminum



**SC7045D** ◀

**SC7045E** ◀

**SC7045G** ◀  
color optional:  
blue, purple

**SC7045H** ◀



**SC7040HD** ◀  
Extra-Wide Bariatric Commode Chair

- ★ Steel frame with powder coating, drop-down armrest
- ★ Seat Width: 63.5cm
- ★ Seat Depth: 58.5cm
- ★ Seat Height: 49.5cm - 60cm
- ★ Overall Width: 82cm
- ★ Packing size: 93\*60\*49.5cm, 2pcs/ctn
- ★ N.W 18.4KG G.W20.5KG
- ★ Weight Capacity: 200KG(450lbs)



**SC7045A** ◀  
Commode Seat

**SC7045B** ◀  
Commode Seat

**SC7045C** ◀  
Commode Seat

Size(cm) Model No.:	Icons									PCS	DIM	Kg	NW	GW	Loading Capacity	
	1	2	3	4	5	6	7	8	9						20FT	40HQ
SC7030	79	82	42	-	-	17	58	65-75	46-56	2	82*55*58	100	6.7/15.2	220	540	
SC7040	64	46	40	-	-	20	46	62-77	42-57	4	66*66*66	100	6.0/25.8	388	944	
SC7040L	65	47	37	-	-	22	43	61-71	41-51	4	66*66*66	100	3.4/8.6	388	944	
SC7040HD	72	58	-	-	-	28	52	76-86	50-60	2	93*60*49.5	200	18.4/20.5	200	490	
SC7045A	39	-	-	-	-	-	40	40	40	6	76*36*41	100	1.7/12	1500	3660	
SC7045B	39	-	-	-	-	-	40	45	45	2	68*21*41	100	2.4/6.6	960	2300	
SC7045C	54	43	40	-	-	36	50	78	78	4	80*47*57	100	3.8/17.0	520	1280	



**SC7050B** ◀  
Commode Frame,  
KD Design

**SC7050B-S** ◀

**SC7050B-F** ◀



**SC7050C** ◀  
Commode Frame,  
W/Basket



**SC7055B** ◀  
Toilet Safety Rail  
Hole distance:  
US-Style 139mm  
EU-Style 155mm



**SC7055D** ◀  
Toilet Safety Rails



**SC7070A** ◀  
commode chair with  
soft padded



**SC7070A-KD** ◀  
commode chair with  
soft padded





**SC7060A**  
Raised Toilet Seat



**SC7060B**  
Raised Toilet Seat W/Armrest

Quick-release



**SC7060H** Raised toilet seat with drop down armrest

- ☆ Universal-mounted module design ensure secure
- ☆ Easy locking onto toilet
- ☆ Height: 165mm
- ☆ Width: 360mm
- ☆ Depth: 400mm



**SC7060B-L** Toilet Seat Chair, Amrest detachable  
☆ Packing: 53\*20\*45cm 1PC/CTN



**SC7060B-N**  
Raised Toilet Seat W/Armrest and Lid



**SC7060C-PU**  
SOFT PU Raised Toilet Seat W/O Lid, Blue



**SC7060PU-2**  
PU Seat, 2 inch



**SC7060PU-4**  
PU Seat, 4 inch



**SC7060C-2**  
Raised Toilet Seat W/O LID



**SC7060C-4**  
Raised Toilet Seat W/O LID



**SC7060C-6**  
Raised Toilet Seat W/O LID



**SC7060D-2**  
Raised Toilet Seat W/lid



**SC7060D-4**  
Raised Toilet Seat W/lid



**SC7060D-6**  
Raised Toilet Seat W/lid



**SC7060F**  
Raised Toilet Seat with quick-clip design  
Optional 2/4/6"  
Optional Lid or W/O Lid



**SC7060P**  
Bidet



**SC7061A**  
Bedpan



**SC7061AB**  
Bedpan W/handle



**SC7061AC**  
Bedpan W/Lid, Blue



**SC7061ACW**  
Bedpan W/Lid, White



**SC7061B**  
Bedpan W/handle



**SC7061S**  
Bedpan, stainless steel



**SC7062A**  
Male Urine, 1000ML/PC



**SC7062B**  
Male Urine, 1000ML/PC



**SC7062W**  
Male Urine, 1000ML/PC, white



**SC7063**  
Male Urine, 1000ML/PC



**SC7064W**  
Female Urine, 1000ML/PC, white



**SC7065**  
Unisex Urine, 1000ML/PC



**SC8001A**

- ★ Fixed Armrest/Footrest
- ★ Soft Seat with a hole part
- ★ Steel frame with Chrome finish
- ★ 8" front castor and 24" rear spoken wheel



**SC8005A**

- ★ Fixed Armrest/Footrest
- ★ PVC Seat
- ★ Steel frame with Chrome finish
- ★ 8" front castor and 24" rear spoken wheel



**SC8015A**

- ★ Drop-down Armrest and Detachable Footrest
- ★ PVC Seat
- ★ Steel frame with Chrome finish
- ★ 5" front castor and 2 with brakes



**SC8015C**

- ★ Drop-down Armrest and Detachable Footrest
- ★ PVC Seat
- ★ Steel frame with powder-coating finish
- ★ 5" front castor and 2 with brakes



**SC8005B**

- ★ Fixed Armrest/Footrest
- ★ PVC Seat
- ★ Steel frame with Chrome finish
- ★ 8" front castor and 24" rear Mag wheel



**SC8010**

- ★ Detachable Armrest/Footrest
- ★ PVC Seat
- ★ Steel frame with Chrome finish
- ★ 8" front castor and 24" rear spoken wheel



**SC8015D**

- ★ Drop-down Armrest and Detachable Footrest
- ★ PU Seat
- ★ Stainless steel frame
- ★ 5" front castor and 2 with brakes



**SC8015F-KD Steel Commode Chair with KD design**

- ★ Drop-down Armrest and Detachable footrest
- ★ Backrest can be detachable
- ★ PU Seat
- ★ Steel frame with popcorn painted
- ★ 5" front castor and 2 with brakes

Size(cm) Model No.	Icon 1	Icon 2	Icon 3	Icon 4	Icon 5	Icon 6	(Kg)	DIM	NW/GW
SC8001A	64	44	58	20	50	87	100	92*29*89	19/21.3
SC8005A	63	44	59	20	52	87	100	92*28*88	20/23
SC8005B	64	44	60	20	52	88	100	93*29*90	20/22
SC8010	60	45	58	15	53	90	100	75*28*91	19.6/21.4

Size(cm) Model No.	Icon 1	Icon 2	Icon 3	Icon 4	Icon 5	Icon 6	(Kg)	DIM	NW/GW
SC8015A	55	43	12	12	52	92	100	55*53*52	13/15
SC8015C	55	43	12	12	52	92	100	55*53*52	13/15
SC8015D	54	44	12.5	12.5	51	96.5	100	54*52.5*56	12.3/13.8
SC8015F-KD	59	44	12	12	52	92	100	55*53*52	13/15

## Commode Wheelchair Series

## Steel Wheelchair Series



**SC8015E**

- ☆ Drop-down Armrest and Detachable Footrest
- ☆ PU Seat
- ☆ Stainless steel frame and Aluminum Backrest
- ☆ 5" front castor and 2 with brakes



**SC8020A**

- ☆ Drop-down Armrest and Elevating Footrest
- ☆ PVC Seat
- ☆ Steel with Chrome finish
- ☆ 8" front castor and 24" spoken rear wheel



**SC8020B**

- ☆ Drop-down Armrest and Elevating Footrest
- ☆ Soft Seat with hole part
- ☆ Steel with Chrome finish
- ☆ 8" front castor and 24" spoken rear wheel



**SC8020C**

- ☆ Drop-down Armrest and Elevating Footrest
- ☆ Soft Seat with hole part
- ☆ Aluminum lightweight and durable frame
- ☆ 8" front castor and 24" spoken rear wheel

Size(cm) Model No.:	A	B	C	D	E	F	G (Kg)	DIM	NW GW
SC8015E	54	44	12.5	12.5	50	97	100	61*55*55	12.2/14.4
SC8020A	63	46	60	20	50	120	100	95*34*93	26.5/28.5
SC8020B	63	44	57	20	53	128	100	88*37*100	26.5/28.5
SC8020C	64	46	60	20	52	122	100	97*41*86	26.1/28.1



**SC9001**

- ☆ 18" seat width
- ☆ Fixed Armrest/Footrest
- ☆ PVC leather upholstery
- ☆ Steel Frame with Chrome finish
- ☆ 8" front castor and 24" rear spoken wheel with solid tire



**SC9001P**

- ☆ 18" seat width
- ☆ Fixed Armrest/Footrest
- ☆ PVC leather upholstery
- ☆ Steel Frame with Powder-coating finish
- ☆ 8" front castor and 24" rear spoken wheel with solid tire



**SC9002W**

- ☆ 20" seat width
- ☆ Fixed Armrest/Footrest
- ☆ PVC leather upholstery
- ☆ Double cross bar and Steel frame with Chrome finish
- ☆ 8" front castor and 24" rear spoken wheel with solid tire



**SC9010**

- ☆ 18" seat width
- ☆ Fixed Armrest and Detachable Footrest
- ☆ PVC leather upholstery
- ☆ Steel Frame with Chrome finish
- ☆ 8" front castor and 24" rear spoken wheel with solid tire

Size(cm) Model No.:	A	B	C	D	E	F	G (Kg)	DIM	NW GW
SC9001	64	46	59	20	51	87	100	93*21*88	17/19
SC9001P	64	46	59	20	51	87	100	93*21*88	17/19
SC9002W	71	51	59	20	51	87	100	92*29*88	19/21
SC9010	64	46	59	20	59	87	100	80*24*88	17/21

## Steel Wheelchair Series



**SC9010P**

- ☆ 18" seat width
- ☆ Fixed Armrest and Detachable Footrest
- ☆ PVC leather upholstery
- ☆ Steel Frame with Powder-coating finish
- ☆ 8" front castor and 12" rear mag wheel with PU tire



**SC9010PM**

- ☆ 18" seat width
- ☆ Fixed Armrest and Detachable Footrest
- ☆ Nylon Fabric upholstery
- ☆ Steel Frame with Powder-coating finish
- ☆ 8" front castor and 24" rear mag wheel with solid tire



**SC9010PMD**

- ☆ 18" seat width
- ☆ Detachable Armrest and \ Footrest
- ☆ Nylon Fabric upholstery
- ☆ Steel Frame with Powder-coating finish
- ☆ 8" front castor and 24" rear mag wheel with solid tire



**SC9010W-20**

- ☆ 20" seat width
- ☆ Fixed Armrest and Detachable Footrest
- ☆ Nylon Fabric upholstery
- ☆ Double Cross bar with Powder-coating finish
- ☆ 8" front castor and 24" rear Spoken wheel with solid tire

Size(cm) Model No.	⊠	⊠	⊠	⊠	⊠	⊠	(Kg)	DIM	NW GW
SC9010P	59	41	30	20	48	88	100	77*25*89	14/16
SC9010PM	63	43	59	20	50	89	100	79*25*89	17.5/19.5
SC9010PMD	64	43	60	20	48	88	100	79*25*92	16.5/18.5
SC9010W-2	70	51	59	20	49	91	100	80*28*93	18/20

## Steel Wheelchair Series



**SC9020**

- ☆ 18" seat width
- ☆ Detachable Armrest and Detachable Footrest
- ☆ PVC leather upholstery
- ☆ Steel Frame with Chrome finish
- ☆ 8" front castor and 24" rear Spoken wheel with solid tire



**SC9020D**

- ☆ 18" seat width
- ☆ Detachable Armrest and Detachable Footrest
- ☆ PVC leather upholstery
- ☆ Steel Frame with Chrome finish
- ☆ 8" front foam castor and 24" rear Spoken wheel with solid tire



**SC9020P**

- ☆ 18" seat width
- ☆ Detachable Armrest and Detachable Footrest
- ☆ Nylon Fabric upholstery
- ☆ Steel Frame with Powder-coating finish
- ☆ 8" front castor and 24" rear Spoken wheel with solid tire



**SC9020PS**

- ☆ 18" seat width
- ☆ Detachable Armrest and Detachable Footrest
- ☆ PVC leather upholstery
- ☆ Steel Frame with Powder-coating finish
- ☆ 8" front foam castor and 12" rear mag wheel with PU tire

Size(cm) Model No.	⊠	⊠	⊠	⊠	⊠	⊠	(Kg)	DIM	NW GW
SC9020	64	46	59	20	50	80	100	79*27*89	16.7/18.7
SC9020D	66	46	59	20	50	89	100	80*29*89	16.7/18.7
SC9020P	66	46	59	20	50	89	100	79*27*89	16.7/18.7
SC9020PS	57	46	30	20	50	86	100	80*26*89	14.9/16.9



**SC9056**

- ★ 18" seat width
- ★ Flip up Armrest and Detachable Footrest
- ★ Double Cross, Steel Frame with Powder-coating finish
- ★ Nylon Fabric upholstery
- ★ 8" front foam castor and 24" rear mag wheel with solid tire



**SC9020W-20**

- ★ 20" seat width
- ★ Detachable Armrest and Detachable Footrest
- ★ PVC leather upholstery
- ★ Steel Frame with Chrome finish
- ★ 8" front castor and 24" rear Mag wheel with solid tire



**SC9025**

- ★ 18" seat width
- ★ Detachable Armrest and Elevating Footrest
- ★ PVC leather upholstery
- ★ Steel Frame with Chrome finish
- ★ 8" front castor and 24" rear Spoken wheel with pneumatic tire



**SC9025PMD**

- ★ 18" seat width
- ★ Detachable Armrest and Elevating Footrest
- ★ Nylon Fabric upholstery
- ★ Steel Frame with Powder-coating finish
- ★ 8" front castor and 24" rear mag wheel with solid tire



**SC9035A**

- ★ 17" seat width
- ★ Steel Frame with coating finish
- ★ Detachable Armrest and Elevating Footrest
- ★ Loop and hand brakes for easily using
- ★ 8" front castor and 24" Spoken rear wheel with solid tire



**SC9035B**

- ★ 17" seat width
- ★ Steel Frame with coating finish
- ★ Detachable Armrest and Elevating Footrest padded
- ★ Comfortable headrest
- ★ 8" front castor and 24" Spoken rear wheel with solid tire



Size(cm) Model No.	A	A	⊗	⊗	⊗	⊗	⊗ (Kg)	DIM	NW GW
SC9056	64	46	59	20	50	95	100	80*26*85	19/21
SC9020W-20	76	56	62	20	46	87	100	79*28*94	21.5/22.5
SC9025	67	43	59	20	50	90	100	79*28*89	18.5/20.5
SC9025PMD	67	43	59	20	50	90	100	79*28*89	18.5/20.5

Size(cm) Model No.	A	A	⊗	⊗	⊗	⊗	⊗ (Kg)	DIM	NW GW
SC9035A	63	43	59	20	46	95	100	94*32*92	24.6/26.6
SC9035B	63	43	59	20	46	95	100	94*32*92	24.6/26.6

## Steel Wheelchair Series

## Aluminum Wheelchair Series



**SC9030A-14**

- ☆ 14" seat width
- ☆ Fixed Armrest/Footrest
- ☆ Nylon Fabric upholstery
- ☆ Steel Frame with powder-coating finish
- ☆ 6" front castor and 20" rear Spoken wheel with PU tire



**SC9030B-14**

- ☆ 14" seat width
- ☆ Flip up Armrest and Detachable Footrest
- ☆ Nylon fabric upholstery
- ☆ Aluminum Frame with colorful coating
- ☆ 6" front castor and 22" rear Spoken wheel with PU tire



**SC9555**

- ☆ Aluminum Lightweight Manual Wheelchair, 17" seat width
- ☆ Foldable backrest
- ☆ Fixed Armrest and swing-away footrest
- ☆ Loop and hand brake combined
- ☆ 6" front castor and 12" rear Spoken wheel with PU tire



**SC9560**

- ☆ Aluminum Lightweight Manual Wheelchair, 17" seat width
- ☆ Foldable backrest
- ☆ Fixed Armrest and swing-away footrest
- ☆ Loop and hand brake combined
- ☆ 6" front castor and 12" rear Spoken wheel with PU tire



**SC9030C**

- ☆ 14", 16", 18" seat width
- ☆ Aluminum Lightweight and durable frame
- ☆ 5" front castor and 8" rear PVC wheel
- ☆ Flip up armrest and movable footplate
- ☆ With locking united brake and seat belt



**SC9545C**

- ☆ 14" or 18" seat width
- ☆ Reclining backrest, adjustable seat angle
- ☆ Detachable armrest and footrest
- ☆ Loop and hand brake combined
- ☆ 6" front castor and 12" rear mag wheel with PU tire



**SC9565**

- ☆ 19" seat width
- ☆ Foldable backrest
- ☆ Flip up Armrest and Fixed footrest
- ☆ 6" front castor and 12" rear Spoken wheel with PU tire



Size(cm) Model No.	Icon 1	Icon 2	Icon 3	Icon 4	Icon 5	Icon 6	(Kg)	DIM	NW GW
SC9030A-14	55	35	56	15	50	85	100	85*27*87	10.5/12.5
SC9030B-14	58	35	56	15	45	84	100	87*33*73	14/16
SC9030C	49	36	20	12.5	49	91	100	52*33*74	8/9
SC9545C	57	36	40.6	15	52	94	100	88*33*100	23/25

Size(cm) Model No.	Icon 1	Icon 2	Icon 3	Icon 4	Icon 5	Icon 6	(Kg)	DIM	NW GW
SC9555	54	43	30	15	47	87	100	64*28*71	9.6/11.6
SC9560	59	43	20	20	50	95	100	64*25*78	10/12
SC9565	53	48	30	15	46	88	100	77*27*70	9.6/11.6





**SC9509**

- ☆ Aluminum Lightweight Manual Wheelchair, 17" seat width
- ☆ Flip up Armrest and Swing-away footrest
- ☆ Foldable backrest
- ☆ Adjustable seat height
- ☆ 6" front castor and 24" rear Spoken wheel with PU tire



**SC9535**

- ☆ Aluminum Lightweight Manual Wheelchair, 17" seat width
- ☆ Fixed Armrest/Footrest
- ☆ 6" front castor and 16" rear Mag wheel with PU tire
- ☆ Double Cross Bar
- ☆ Loop and hand brake systems



**SC9585**

- ☆ 18" seat width
- ☆ Aluminum frame with Double Cross bar
- ☆ Fixed Armrest and footrest
- ☆ Loop and hand brake combined
- ☆ 6" front castor and 22" rear Spoken wheel with pneumatic tire



**SC9586**

- ☆ 18" seat width
- ☆ Aluminum frame with Double Cross bar
- ☆ Fixed Armrest and footrest
- ☆ Loop and hand brake combined
- ☆ 6" front castor and 16" rear Spoken wheel with PU tire



**SC9580A**

- ☆ 17" seat width
- ☆ Aluminum frame with powder-coating finish
- ☆ Fixed Armrest and detachable footrest
- ☆ 4\*8" castors



**SC9587**

- ☆ 18" seat width
- ☆ Aluminum frame with Double Cross bar
- ☆ Fixed Armrest and footrest
- ☆ Loop and hand brake combined
- ☆ 8" front castor and 24" rear Spoken wheel with PU tire



**SC9588**

- ☆ 17" or 20" seat width optional
- ☆ Aluminum frame with Double Cross bar
- ☆ Flip up armrest and detachable footrest
- ☆ 8" front castor and 24" rear Spoken wheel with pneumatic tire

Size(cm) Model No.	A	A	B	B	C	C	(Kg)	DIM	NW GW
SC9509	64	46	60	20	50	93	100	86*30*78	14/16
SC9535	56	43	30	15	47	89	100	75*24*90	10.5/12.5
SC9580A	59	43	20	20	50	95	100	84*25*78	10/12

Size(cm) Model No.	A	A	B	B	C	C	(Kg)	DIM	NW GW
SC9585	62	43	38	15	43	84	100	82*28*88	11.6/13.6
SC9586	63	43	56	15	44	85	100	90*28*88	13/15
SC9587	65	46	59	20	50	86	100	97*24*91	14/16
SC9588	74	56	61	20	52	97	100	80*34*90	23/25

**SC9590**

- ☆ 18" Deluxe Light Weight Aluminum Wheelchair
- ☆ Foldable backrest, flip up and detachable armrest
- ☆ Detachable footrest
- ☆ 200\*50 PU castor and 24" quick release PU rear spoke wheel
- ☆ Rear wheel adjustable height in 5 steps



**SC9595**

- ☆ 18" seat width with soft cushion
- ☆ Foldable backrest
- ☆ Fixed armrest and flip-up footrest
- ☆ Loop and hand brake combined
- ☆ 6" front castor and 24" rear spoken wheel with PU tire

**SC9595B**

- ☆ 18" seat width
- ☆ Aluminum frame with Double Cross bar
- ☆ Foldable backrest
- ☆ Fixed armrest and flip-up footrest
- ☆ Loop and hand brake combined
- ☆ 6" front castor and 12" mag spoken wheel with PU tire



**SC9594**

- ☆ 18" seat width with soft cushion
- ☆ Foldable backrest
- ☆ Flip up armrest and detachable footrest
- ☆ Loop and hand brake combined
- ☆ 8" front castor and 24" rear spoken wheel with PU tire

Size(cm) Model No.:										
							(Kg)	DIM	NW GW	
SC9590	64	46	60	20	52	98	130	80*32*80	14/16	
SC9594	62	46	60	20	52	94	120	88*32*78	14/16	
SC9595	65	46	51	20	46	86	100	97*24*71	11/13.4	
SC9595B	58	46	30	15	47	89	100	71*28*70	8/9	





**SC-EW01**

- ☆ 18" seat width
- ☆ Chromed steel foldable
- ☆ Battery on side, foldable electric wheelchair,
- ☆ Foldable backrest,
- ☆ Flip up PU armrest and detachable legrest,
- ☆ 200\*50 PU castor, 8"PU rear wheel.
- ☆ China joystick.
- ☆ 300W motor x2, lead-acid battery x2, 12V 20AH.
- ☆ double soft cushion

**SC-EW04**

- ☆ 18" seat width
- ☆ Aluminum construction
- ☆ Foldable backrest,
- ☆ Flip up PU armrest and swing away legrest
- ☆ 24" Spoke wheel with PU solid Tyre, 8" Solid PU castor,
- ☆ China joystick
- ☆ 200W motor x2, lead-acid battery x2, 24V 24AH.
- ☆ double soft cushion



**SC-EW02**

- ☆ 18" seat width
- ☆ Aluminum construction
- ☆ Foldable backrest,
- ☆ Flip up PU armrest and detachable legrest
- ☆ 200\*50 PU castor, 8"PU rear wheel
- ☆ China joystick
- ☆ 300W motor x2, lead-acid battery x2, 24V 20AH.
- ☆ double soft cushion



**SC-EW03**

- ☆ 18" seat width
- ☆ Aluminum construction
- ☆ Foldable backrest,
- ☆ Flip up PU armrest and swing away legrest
- ☆ 200\*50 PU castor, 8"PU rear wheel
- ☆ China joystick
- ☆ 200W motor x2, lead-acid battery x2, 24V 24AH.
- ☆ double soft cushion



**SC-EW06**

- ☆ 17" seat width
- ☆ Aluminum construction
- ☆ Foldable backrest,
- ☆ Flip up PU armrest and foldable legrest
- ☆ 10" rear PU solid Tyre, 8" Solid PU castor,
- ☆ China joystick
- ☆ 230W motor x2, lead-acid battery x2, 24V 12AH.
- ☆ soft cushion

**SC-EW05**

- ☆ 18" seat width
- ☆ Aluminum construction
- ☆ Foldable backrest,
- ☆ Flip up PU armrest and swing away legrest
- ☆ 24" Spoke wheel with PU solid Tyre, 8" Solid PU castor,
- ☆ PG joystick
- ☆ 200W motor x2, LI-ion battery x2, 24V 11AH.
- ☆ double soft cushion



Size(cm)	Model No.	⊠	⊥	⊠	⊙	⊙	⊙	⊙	⊙	⊙	⊙	KM	W	(Kg)	DIM	PCS	NW GW
60	SC-EW01	33	46	30	20	48	94	94	40	46	12	20	300*2	120	100*45*83	1	34/36
68	SC-EW02	42	46	55	20	52	96	113	43	45	12	20	300*2	120	100*45*83	1	32/34
63	SC-EW03	36	46	30	20	52	96	110	43	45	12	20	200*2	125	81*43*76	1	45/48

Size(cm)	Model No.	⊠	⊥	⊠	⊙	⊙	⊙	⊙	⊙	⊙	KM	W	(Kg)	DIM	PCS	NW GW	
68	SC-EW04	45	46	55	20	52	96	110	43	45	12	20	200*2	125	89*47.5*78	1	42/45
69	SC-EW05	37	46	55	20	52	96	110	43	45	12	20	200*2	125	89*47.5*78	1	36.5/39
56	SC-EW06	56	44	30	20	47	92	87	42	47	12	15	230*2	120	62*35.5*79	1	20.5/23





**SC-MB01A 1-crank Manual Bed**

- ☆ **Overall dimension:** L2120\*W900\*H500mm
- ☆ **Description/Features**
- ☆ Flexible bedstead with anti-bacteria double powder coating treatment
- ☆ High durable retractable Built-in Crank with universal linking card structure, safe, quiet and smooth operation
- ☆ Backrest tilting: 60±5°
- ☆ Detachable Plastic Bed Head/Foot board
- ☆ Collapsible Aluminum side rails
- ☆ 5" castor with brake on the cross
- ☆ **Equipment:** I.V. Pole
- ☆ **Optional:** Mattress, Bedside Cabinet, Overbed Table and Food board



**SC-MB02D 2-crank Luxurious Manual Bed**

- ☆ **Overall dimension:** L2170\*W900\*H500mm
- ☆ **Description/Features**
- ☆ Flexible bedstead with anti-bacteria double powder coating treatment
- ☆ Durable and stronger bed board with soft connection
- ☆ High durable retractable Built-in Crank with universal linking card structure, safe, quiet and smooth operation.
- ☆ Backrest tilting: 60±5°
- ☆ Knee board tilting: 35±5°
- ☆ Detachable ABS Plastic Bed Head/Foot board
- ☆ Down-loading ABS side rails
- ☆ 6" castor with central locking system
- ☆ **Equipment:** I.V. Pole
- ☆ **Optional:** Mattress, Bedside Cabinet, Overbed Table and Food board



**SC-MB02A 2-crank Manual Bed**

- ☆ **Overall dimension:** L2120\*W900\*H500mm
- ☆ **Description/Features**
- ☆ Flexible bedstead with anti-bacteria double powder coating treatment
- ☆ High durable retractable Built-in Crank with universal linking card structure, safe, quiet and smooth operation.
- ☆ Backrest tilting: 60±5°
- ☆ Knee board tilting: 35±5°
- ☆ Detachable Plastic Bed Head/Foot board
- ☆ Collapsible Aluminum side rails
- ☆ 5" castor with brake on the cross
- ☆ **Equipment:** I.V. Pole
- ☆ **Optional:** Mattress, Bedside Cabinet, Overbed Table and Food board



**SC-MB03A 3-crank Manual Bed**

- ☆ **Overall dimension:** L2120\*W900\*H500-750mm
- ☆ **Description/Features**
- ☆ Flexible bedstead with anti-bacteria double powder coating treatment
- ☆ High durable retractable Built-in Crank with universal linking card structure, safe, quiet and smooth operation.
- ☆ Backrest tilting: 60±5°
- ☆ Knee board tilting: 35±5°
- ☆ Hi-lo: 500-750mm
- ☆ Detachable Plastic Bed Head/Foot board
- ☆ Collapsible Aluminum side rails
- ☆ 5" castor with brake on the cross
- ☆ **Equipment:** I.V. Pole
- ☆ **Optional:** Mattress, Bedside Cabinet, Overbed Table and Food board



**SC-MB02M 2-crank Manual Bed**

- ☆ **Overall dimension:** L2120\*W900\*H500mm
- ☆ **Description/Features**
- ☆ Flexible bedstead with anti-bacteria double powder coating treatment
- ☆ Mesh bed board
- ☆ High durable retractable Built-in Crank with universal linking card structure, safe, quiet and smooth operation.
- ☆ Backrest tilting: 60±5°
- ☆ Knee board tilting: 35±5°
- ☆ Detachable Plastic Bed Head/Foot board
- ☆ Collapsible Aluminum side rails
- ☆ 5" castor with brake on the cross
- ☆ **Equipment:** I.V. Pole
- ☆ **Optional:** Mattress, Bedside Cabinet, Overbed Table and Food board



**SC-MB04 4-crank Manual Bed**

- ☆ **Overall dimension:** L2100\*W900\*H500-780mm
- ☆ Flexible bedstead with anti-bacteria double powder coating treatment
- ☆ High durable retractable Built-in Crank with universal linking card structure, safe, quiet and smooth operation.
- ☆ Backrest tilting: 80±5°
- ☆ Knee board tilting: 40±5°
- ☆ Hi-lo: 460-720mm
- ☆ Reverse and trendelenburg: 15±2°
- ☆ Detachable Plastic Bed Head/Foot board
- ☆ Collapsible Aluminum side rails
- ☆ 5" castor with brake on the cross
- ☆ **Equipment:** I.V. Pole
- ☆ **Optional:** Mattress, Bedside Cabinet, Overbed Table and Food board



**SC-EB02A 2-Motor Electric Bed**

- ☆ **Overall dimension:** L2120\*W900\*H490mm
- ☆ **Description/Features**
- ☆ Flexible bedstead with anti-bacteria double powder coating treatment
- ☆ 2-Motor made in China
- ☆ Backrest tilting:  $80\pm 5^\circ$
- ☆ Knee board tilting:  $40\pm 5^\circ$
- ☆ Detachable Plastic Bed Head/Foot board
- ☆ **Equipment:** I.V. Pole
- ☆ **Optional:** Mattress, Bedside Cabinet, Overbed Table and Food board



**SC-EB03A 3-motor Electric Bed**

- ☆ **Overall dimension:** L2120\*W900\*H500~750mm
- ☆ **Description/Features**
- ☆ Flexible bedstead with anti-bacteria double powder coating treatment
- ☆ 3-Motor made in China
- ☆ Backrest tilting:  $60\pm 5^\circ$
- ☆ Knee board tilting:  $35\pm 5^\circ$
- ☆ Hi-lo: 500~750mm
- ☆ Detachable Plastic Bed Head/Foot board
- ☆ Down-load ABS side rails
- ☆ 6" castor with central brake system
- ☆ **Equipment:** I.V. Pole
- ☆ **Optional:** Mattress, Bedside Cabinet, Overbed Table and Food board



**SC-EB03D 3-motor Electric Bed**

- ☆ **Overall dimension:** L2120\*W900\*H500~750mm
- ☆ **Description/Features**
- ☆ Flexible bedstead with anti-bacteria double powder coating treatment
- ☆ 3-Motor made in china
- ☆ Backrest tilting:  $60\pm 5^\circ$
- ☆ Knee board tilting:  $35\pm 5^\circ$
- ☆ Hi-lo: 500~750mm
- ☆ Detachable Plastic Bed Head/Foot board
- ☆ **Equipment:** I.V. Pole
- ☆ **Optional:** Mattress, Bedside Cabinet, Overbed Table and Food board



**SC-EB03E 3-motor Electric Bed With Built In Control Panel**

- ☆ **Overall dimension:** L2170\*W900\*H500mm
- ☆ **Description/Features**
- ☆ Flexible bedstead with anti-bacteria double powder coating treatment
- ☆ Durable and stronger bed board with soft connection
- ☆ High durable retractable Built-in Crank with universal linking card structure, safe, quiet and smooth operation.
- ☆ Backrest tilting:  $60\pm 5^\circ$
- ☆ Knee board tilting:  $35\pm 5^\circ$
- ☆ Detachable ABS Plastic Bed Head/Foot board
- ☆ Down-loading ABS side rails
- ☆ 6" castor with central locking system
- ☆ **Equipment:** I.V. Pole
- ☆ **Optional:** Mattress, Bedside Cabinet, Overbed Table and Food board



**SC-EB03F 3-motor Super Low Electric Bed**

- ☆ **Overall dimension:** L2100\*W980\*H270-680mm
- ☆ **Description/Features**
- ☆ Flexible bedstead with anti-bacteria double powder coating treatment
- ☆ 3-Motor made in china
- ☆ Backrest tilting:  $80\pm 5^\circ$
- ☆ Knee board tilting:  $40\pm 5^\circ$
- ☆ Hi-lo: 270-680mm
- ☆ Detachable Plastic Bed Head/Foot board
- ☆ Collapsible Aluminum side rails
- ☆ **Equipment:** I.V. Pole
- ☆ **Optional:** Mattress, Bedside Cabinet, Overbed Table and Food board



**SC-EB05A 5-Function Electric Bed**





**SC-EB05B 5-Function Electric Bed (soft connection board)**

- ☆ **Overall dimension:** L2200\*W1030\*H460~720mm
- ☆ **Description/Features**
- ☆ Flexible bedstead with anti-bacteria double powder coating treatment
- ☆ 4-Motor made in China
- ☆ Backrest tilting: 60±5°
- ☆ Knee board tilting: 35±5°
- ☆ Hi-lo: 500~750mm
- ☆ Reverse and Trendelenburg: 15±2°
- ☆ Detachable plastic Head/Foot board
- ☆ 6" castors with central brake system
- ☆ **Equipment:** I.V. Pole
- ☆ **Optional:** Mattress, Bedside Cabinet, Overbed Table



**SC-ICU-4 6-function Electric Bed**

- ☆ **Overall dimension:** L2240\*W1180\*H510~700mm
- ☆ **Description/Features:**
- ☆ 6-Function motorized
- ☆ Backrest tilting: 0~65°
- ☆ Knee board tilting: 0~45°
- ☆ Hi-lo: 480~680mm
- ☆ Reverse and Trendelenburg: 0~10°
- ☆ Loading Capacity: 250KGS
- ☆ 5.7" luxurious operated LCD
- ☆ Weight scale with accurate measurement system
- ☆ Noble PP bed head/foot board, 4pcs side rails with wireless LCD remote controller..
- ☆ 6" castors with central braking system
- ☆ **Equipment:** I.V. Pole
- ☆ **Optional:** Mattress, Bedside Cabinet, Overbed Table



**SC-EB05C 5-Function Electric Bed With Built In Control Panel**

- ☆ **Overall dimension:** L2240\*W1160\*H480~720mm
- ☆ **Description/Features**
- ☆ Flexible bedstead with anti-bacteria double powder coating treatment
- ☆ 4-Motor made in China
- ☆ Backrest tilting: 80±5°
- ☆ Knee board tilting: 40±5°
- ☆ Hi-lo: 480-720mm
- ☆ Reverse and Trendelenburg: 15±2°
- ☆ Detachable plastic Head/Foot board with built in control panel
- ☆ 6" castors with central brake system
- ☆ **Equipment:** I.V. Pole
- ☆ **Optional:** Mattress, Bedside Cabinet, Overbed Table



**SC-ICU-5 Super-luxurious Electric Bed 6-function Electric Bed**

- ☆ **Overall dimension:** L2310\*W1190\*H510~700mm
- ☆ **Description/Features:**
- ☆ 5-Function motorized
- ☆ Backrest tilting: 0~65°
- ☆ Knee board tilting: 0~45°
- ☆ Hi-lo: 480~680mm
- ☆ Reverse and Trendelenburg: 0~10°
- ☆ Loading Capacity: 250KGS
- ☆ New design noble PP bed head/foot board, 4pcs side rails with easily operated membrane switch
- ☆ 6" castors with central braking system
- ☆ **Equipment:** I.V. Pole
- ☆ **Optional:** Mattress, Bedside Cabinet, Overbed Table



**SC-EB05D 5-Function Electric Bed**

- ☆ **Overall dimension:** L2240\*W980\*H460~720mm
- ☆ **Description/Features**
- ☆ Flexible bedstead with anti-bacteria double powder coating treatment
- ☆ 4-Motor made in China
- ☆ Backrest tilting: 80±5°
- ☆ Knee board tilting: 40±5°
- ☆ Hi-lo: 480-720mm
- ☆ Reverse and Trendelenburg: 15±2°
- ☆ Detachable plastic Head/Foot board
- ☆ **Equipment:** I.V. Pole
- ☆ **Optional:** Mattress, Bedside Cabinet, Overbed Table



**SC-ICU-6 6-function Electric Bed**

- ☆ **Overall dimension:** L2310\*W1190\*H510~700mm
- ☆ **Description/Features:**
- ☆ 5-Function motorized
- ☆ Backrest tilting: 0~65°
- ☆ Knee board tilting: 0~45°
- ☆ Hi-lo: 480~680mm
- ☆ Reverse and Trendelenburg: 0~10°
- ☆ Loading Capacity: 250KGS
- ☆ 10.2" luxurious operated LCD
- ☆ Weight scale with accurate measurement system,
- ☆ New design noble PP bed head/foot board, 4pcs side rails with easily operated membrane switch
- ☆ 6" castors with central braking system
- ☆ **Equipment:** I.V. Pole
- ☆ **Optional:** Mattress, Bedside Cabinet, Overbed Table



### SC-ICU-7 Super-luxurious Electric Bed

- ☆ **Overall dimension:** L2200\*W1030\*H460~720mm
- ☆ **Description/Features:**
- ☆ Back rest tilting: 80°±5°, knee board tilting: 40°±5°
- ☆ Hi-lo adjustment between: 460-720mm;
- ☆ Reverse and trendelenburg 15°±2°;
- ☆ Standard configuration:
- ☆ 2pcs column motors, 2pcs Advanced medical actuators, 1pcs control box,
- ☆ 1pcs ACP(ATTENDENT CONTROL OPERATION PANEL);
- ☆ central-controlled brake system, 4pcs luxurious central locking castors;
- ☆ 1 pair plastic head/foot-end board;
- ☆ 1 pair Luxurious PP siderails
- ☆ 4pcs urine hooks;
- ☆ 1pcs S.S I.V pole;
- ☆ **Options:**
- ☆ Backup power system (UPS); CPR function;
- ☆ Medical mattress; dining board; bedside cabinet;
- ☆ patient file panel; sundries basket



### SC-ICU-8 Super-luxurious Electric Bed

- ☆ **Overall dimension:** L2100\*W980\*H480-740mm
- ☆ **Description/Features:**
- ☆ Back rest tilting: 80°±5°, knee board tilting: 40°±5°
- ☆ Hi-lo adjustment between: 460-720mm;
- ☆ Reverse and trendelenburg 15°±2°; Tilt to right or left: 15°±2°
- ☆ Standard configuration:
- ☆ 2pcs column motors, 2pcs Advanced medical actuators, 1pcs control box,
- ☆ 1pcs ACP(ATTENDENT CONTROL OPERATION PANEL);
- ☆ central-controlled brake system, 4pcs luxurious central locking castors;
- ☆ 1 pair plastic head/foot-end board;
- ☆ 1 pair Luxurious PP side rails
- ☆ 4pcs urine hooks;
- ☆ 1pc S.S I.V pole;
- ☆ **Options:**
- ☆ Backup power system (UPS); CPR function;
- ☆ Medical mattress; dining board; bedside cabinet;
- ☆ patient file panel; sundries basket

### SC-HB01 5-Function Electric Bed

- ☆ **Overall Dimension:** L2080\*W970\*H450~750mm
- ☆ **Description/Features**
- ☆ Flexible bedstead with anti-bacteria double powder coating treatment
- ☆ Imported Linak Motor, which is quiet and weight capacity over 250KGS.
- ☆ Backrest tilting: 0~75°
- ☆ Knee board tilting: 0~40°
- ☆ Hi-lo: 450~750mm
- ☆ Reverse and Trendelenburg: 0~10°
- ☆ Wood Head/Foot board
- ☆ Collapsible Aluminum Side rails
- ☆ 5" castors with brake on the cross
- ☆ Equipment: I.V. Pole
- ☆ **Optional:** Mattress, Bedside Cabinet, Overbed Table



### SC-HB01B Homecare Bed(1-motorised)

- ☆ **Overall Dimension:** L2120\*W970\*H450~480mm
- ☆ **Description/Features**
- ☆ High-quality carbon metal frame
- ☆ MDF bed head/foot board, colors freely to be changed
- ☆ Aluminum side rail provides more safety
- ☆ 6" central locking system
- ☆ Imported motors and make no noise
- ☆ **Backrest:** 0~8°
- ☆ **Optional:** I.V. Stand, Foot Table, Mattress



### SC-HB03B Homecare Electric Bed (3-motorised)

- ☆ **Overall Dimension:** L2100\*W1030\*H460~720mm
- ☆ Back rest tilting: 80°±5°, knee board tilting: 40°±5°
- ☆ Hi-lo adjustment between: 460-720mm
- ☆ Standard configuration:
- ☆ 3pcs Advanced medical actuators, 1pcs control box, 1pcs handset;
- ☆ 4pcs luxurious castors;
- ☆ 1 pair wood head/foot-end boards;
- ☆ 1 pair wood side rails
- ☆ 4pcs urine hooks;
- ☆ 1pc S.S I.V pole;
- ☆ **Options:**
- ☆ Medical mattress; dining board; bedside cabinet;
- ☆ patient file panel; sundries basket

### SC-HB03A Three Function Homecare Electric Bed

- ☆ **Overall dimension:** L2100\*W980\*H460-720mm
- ☆ Back rest tilting: 80°±5°, knee board tilting: 40°±5°
- ☆ Hi-lo adjustment between: 460-720mm;
- ☆ Standard configuration:
- ☆ 4pcs Advanced medical actuators, 1pc control box, 1pc handset;
- ☆ central-controlled brake system, 4pcs luxurious central locking castors;
- ☆ 1 pair Luxurious wood head/foot-end board;
- ☆ 1 pair Luxurious wood and aluminium siderails
- ☆ 4pcs urine hooks;
- ☆ 1pc S.S I.V pole;
- ☆ **Options:**
- ☆ Backup power system (UPS); CPR function;
- ☆ Medical mattress; dining board; bedside cabinet;
- ☆ patient file panel; sundries basket.







- SC-BP01 Plain Bed**
- ☆ Completely metal frame
  - ☆ Φ38 Bed Head/Foot Board
  - ☆ Bed surface made of cold roll steel sheet
  - ☆ Bed size: 2000\*900\*500mm
  - ☆ **Optional:** castor, Side rail, Shoe rack, Dinning Table, I.V. pole



- SC-BM01 1-crank Manual Bed**
- ☆ Completely metal frame
  - ☆ Φ38 Bed Head/Foot Board
  - ☆ Bed surface made of cold roll steel sheet
  - ☆ Bed size: 2080\*900\*500mm
  - ☆ **Optional:** castor, Side rail, Shoe rack, Dinning Table, I.V. pole



- SC-BM02A 2-crank Manual Bed**
- ☆ **Overall Dimension:** 2000\*900\*480mm
  - ☆ Description/Features
  - ☆ High-quality carbon metal frame
  - ☆ Φ32mm tube bed head/foot with Patient card holder
  - ☆ Backrest: 0~80°
  - ☆ Footrest: 0~45°
  - ☆ **Optional:** I.V. Stand, Foot Table Mattress, Castor



- SC-BM02F 2-crank Manual Bed**
- ☆ **Overall Dimension:** 2000\*900\*480mm
  - ☆ Description/Features
  - ☆ High-quality carbon metal frame
  - ☆ Φ32mm tube bed head/foot withMDF Board
  - ☆ Backrest: 0~80°
  - ☆ Footrest: 0~45°
  - ☆ **Optional:** I.V. Stand, Foot Table Mattress, Castor



- SC-BH01 Hand-lifting Bed**
- ☆ Completely metal frame
  - ☆ Φ38 Bed Head/Foot Board
  - ☆ Bed surface made of cold roll steel sheet
  - ☆ Bed size: 2000\*900\*500mm
  - ☆ **Optional:** Side rail, Dinning Table, I.V. pole



- SC-OB01A Orthopedics Bed**
- ☆ **Overall dimension:** L2210\*W1000\*450mm
  - ☆ Description/Features:
  - ☆ Backrest tilting: 0~80°
  - ☆ Leg board tilting: 0~40°
  - ☆ **Equipment:** I.V.Pole
  - ☆ **Optional:** mattress

- SC-OB01B Orthopedics Bed**
- ☆ **Overall dimension:** L2200\*W980\*490mm
  - ☆ Description/Features:
  - ☆ Backrest tilting: 80±5°
  - ☆ Leg board tilting: 40±5°
  - ☆ **Equipment:** I.V.Pole
  - ☆ **Optional:** mattress



- SC-OB02 Orthopedics Bed**
- ☆ **Overall dimension:**L2200\*W980\*490~720mm
  - ☆ Description/Features:
  - ☆ Backrest tilting: 80±5°
  - ☆ Leg board tilting: 40±5°
  - ☆ Hi-lo: 490~720mm
  - ☆ **Equipment:** I.V.Pole
  - ☆ **Optional:** mattress



**SC-CB01 S/S Child Bed**

- ☆ Overall dimension: 1600\*700\*500mm
- ☆ Description/Features
- ☆ Completely Stainless steel frame
- ☆ 3" castor with brakes
- ☆ Drop-down Siderails
- ☆ Optional: I.V. Stand, Mattress



**SC-CB02 Flat Child Bed**

- ☆ Overall dimension: 1600\*700\*630mm
- ☆ Description/Features
- ☆ High-quality carbon metal frame
- ☆ Bed head/foot with colorful MDF Board
- ☆ Slide-down Siderail for easy using
- ☆ Optional: I.V. Stand, Mattress



**SC-BC01 Baby Bed**

- ☆ Completely Stainless steel
- ☆ 3" castor with brake on the cross
- ☆ Size: 800\*450\*800mm



**SC-BB02 Baby Bed**

- ☆ Specification: 80\*60\*80mm
- ☆ Material: stainless steel
- ☆ Plastic basket could loading more items for baby use



**SC-CB03 1-Crank Child Bed**

- ☆ Overall dimension: 1600\*700\*630mm
- ☆ Description/Features
- ☆ High-quality carbon metal frame
- ☆ Bed head/foot with colorful MDF Board
- ☆ Slide-down Siderail for easy using
- ☆ Backrest: 0~80°
- ☆ Optional: I.V. Stand, Mattress



**SC-CB04 2-Motorised Child Bed**

- ☆ Overall dimension: 1600\*700\*630mm
- ☆ Description/Features
- ☆ High-quality carbon metal frame
- ☆ Bed head/foot with colorful MDF Board
- ☆ Slide-down Siderail for easy using
- ☆ Backrest: 0~80°
- ☆ Hi-to: 630~1300mm
- ☆ Optional: I.V. Stand, Mattress



**SC-BB04A Baby Bed**



**SC-BB04B Baby Bed W/SCALE**



**SC-BB04C Baby Bed W/SCALE**

- ☆ Height adjustable from 780~980 via gas spring
- ☆ Aluminium column, transparent and hi-intensity baby basin
- ☆ Trenslenburge /anti-trenslenburge function together
- ☆ Colors available at Green, Pink and Blue



**SC-GB01&02 Gynaecological Bed**

- ★ Stainless steel Construction
- ★ Size: 1820\*550\*800mm
- ★ High Density foam with PU leather



**SC-EC03 Examination Couch (1-hand work)**

- ★ Size: 1900\*650\*750mm
- ★ Metal Frame with Detachable Leg and powder-coated
- ★ Centra bar bring more stronger and stable
- ★ Padded Mattress supported via woodplate



**SC-EC04 Examination Couch (1-hand work)**

- ★ Stainless steel Frame with Foldable Led
- ★ 4pc Side Bar Provider more heaby-duty
- ★ Padded Mattress Support Via Woodplate



**SC-EC06 Examination Couch (Slideway work)**

- ★ Stronger Stainless steel Frame
- ★ Comfortable padded Mattress
- ★ Easy Lifting Via Slide Rail
- ★ Paper Roll Device Equipped



**SC-EC11 Electric Examination Couch**

- ★ Size: 2000mm\*600mm\*380-650mm
- ★ Backrest: 0-70
- ★ 5" castor with brake on the cross
- ★ Comfortable Padded Mattress With Fashion Colors



**SC-OT02 UK-Style Table**

- ★ Two adjustable pole make different reclining and angle
- ★ Laminated Table top with size: 60\*44\*1.8cm
- ★ Powder-coated base and down pole but chrome up-poles.
- ★ Height adjustable from 53-83cm



**SC-OT03 Rotating Table**

- ★ Two parts Table Top with one angel adjustable.
- ★ Laminated Table top with size: 89\*38\*1.8cm
- ★ Powder-coated steel "H" base provides security and stability.
- ★ Height adjustable from 53-83cm



**SC-OT04 Overbed Table**

- ★ Laminated Table top with size: 85\*40\*1.8cm
- ★ Powder-coated steel "H" base provides security and stability.
- ★ Height adjustable from 53-83cm
- ★ 4pcs swivel nylon castor allow for easy maneuverability



**SC-OT05 Gas-Spring Working Table**

- ★ Easily assembled.
- ★ Walnut, wood grain low pressure laminate top.
- ★ Top can be raised or lowered in infinite settings between 67-99cm
- ★ Swivel casters allow for easy maneuverability.
- ★ Table top is locked securely when height adjustment handle is released.
- ★ Table top can be raised with the slightest upward pressure



**SC-OT08 Overbed Table, Wood Board**

**SC-OT09 Overbed Table, PP Top**

- ★ Luxurious Aluminum Base Over-bed Table
- ★ Laminated Table top 80\*44\*1.8cm
- ★ Size: 80\*44\*62-92mm
- ★ Spring gas pole adjustment system



**SC-OT11 Multi Table (French-Style)**

- ☆ A versatile table that can be height and angle adjustable
- ☆ Foldable and packed flat for storage and transportation
- ☆ Four 2" swivel casters with brake
- ☆ Table size: 23-5/8" x 15-1/8" (60 x 38.5cm)
- ☆ Wooden table thickness: 18mm
- ☆ Overall width: 23-5/8" (60cm)
- ☆ Overall depth: 17" (43cm)
- ☆ Adjustable height: 26"-38"-1/2" (66-98cm)



**SC-OT12 Dual Action Multi Table**

- ☆ A versatile table that can be height and angle adjustable
- ☆ Foldable and packed flat for storage and transportation
- ☆ 2" swivel casters with brake
- ☆ Tilting Table: 23-5/8" x 15-1/8" (60 x 38.5cm)
- ☆ Side table: 7-7/8" x 15-1/8" (20 x 38.5cm)
- ☆ Wooden table thickness: 18mm
- ☆ Overall width: 32" (81cm)
- ☆ Overall depth: 17" (43cm)
- ☆ Adjustable height: 26"-38"-1/2" (66-98cm)



**SC-L02 Bedside Cabinet W/castor**

- ☆ ABS material
- ☆ Towel hanger
- ☆ Size: 48 x 48 x 76cm
- ☆ Colors available in Blue, Green, Grey



**SC-L04 Bedside Cabinet with shoes Holder**

- ☆ ABS material
- ☆ Towel hanger
- ☆ Size: 48 x 48 x 88cm
- ☆ Colors available in Blue, Green, Grey



**SC-OT13 Mobile Utility Overbed Table (Uk-style)**

- ☆ Flat package for easy transport and storage
- ☆ Mild steel with power-coating
- ☆ Stronger MDF top with different colors available
- ☆ Height adjust and tilt
- ☆ Top size : 610 x 405mm
- ☆ Height: 675-1045mm



**SC-OT14 Overbed Table, Wood Board**



**SC-OT16 Reclining Overbed table**

- ☆ Height adjustable 72-120cm
- ☆ Size: 60 x 40 x 1.8cm
- ☆ Vertical rotation 0°-180°
- ☆ Weight Capacity: 30KG



**SC-L06 Bedside Cabinet W/cup Holder**

- ☆ ABS material
- ☆ Size: 48 x 48 x 88cm
- ☆ Towel hanger
- ☆ Cup holder
- ☆ Colors available in Blue, Green, Grey



**SC-L07 Bedside Cabinet**

- ☆ ABS material
- ☆ Size: 50 x 50 x 70cm
- ☆ Stainless steel Towel hanger
- ☆ 4" x 2" nylon durable castor



**SC-L08**

- ☆ ABS material
- ☆ Size: 47\*45\*72cm
- ☆ Stainless steel Towel hanger
- ☆ 4\*2" nylon durable castor



**SC-L09**

- ☆ Steel Frame with plastic top
- ☆ Size: 48\*40\*82cm
- ☆ Stainless steel Towel hanger
- ☆ 4\*2" nylon durable castor



**SC-L10**

- ☆ Stainless steel material
- ☆ Size: 45\*40\*70cm (OEM accept)
- ☆ Knock-down design
- ☆ Optional: Castor



**SC-L11**

- ☆ PP plastic material
- ☆ Size: 58\*51\*77cm
- ☆ 4\*2" nylon durable castor



**SC-S01 Connect Transfer Stretcher**

- ☆ Manual operations
- ☆ There are 3 Parts, we name it A, B and C, A will be
- ☆ In the operation room, B in outside, when push B to
- ☆ Connect A, then, push C to onto the B as the orbit, lock it well before move B away
- ☆ Hi-lo: 645-920mm
- ☆ Optional with I.V. Pole and Mattress



**SC-S03 Manual Transfer Stretcher**

- ☆ Manual operations, its up when you turn right, otherwise, its downing
- ☆ Hi-lo: 570-860mm
- ☆ Central locking system makes the stretcher more easy to go or stop
- ☆ Optional with I.V. Pole and Mattress



**SC-S05 Hydraulic Transfer Stretcher**

- ☆ Equipped with 2-hydraulic pumps
- ☆ Hi-lo: 550-870mm
- ☆ Central locking system makes the stretcher more easy to go or stop
- ☆ Optional with I.V. Pole and Mattress
- ☆ China pump or Import pumps for your choose



**SC-S07A Electric Transfer Stretcher**

- ☆ It's a type of Electric Transfer Stretcher, functions activated by Electric power and gas spring and cranks
- ☆ Systems together, storage battery available
- ☆ At the head-end, there is a pair of push-handles, can be folded up and down
- ☆ Central-lock castors, diameter 150mm. Matched with direction castor, help the operator controlling the direction easily, Bed board for X-Ray Examination
- ☆ Hi-low range: 80-550mm
- ☆ Bck-rest lifting angle: 0-60°
- ☆ Knee-rest lifting angle: 0-40°
- ☆ Trendelenburg & Rev. Trendelenburg angle: 0-12°
- ☆ Packing: 1.12CBM/PC
- ☆ Net Weight: 110KGS



**SC-S07B Electric Transfer Stretcher**

- ☆ It's a type of Electric Transfer Stretcher, functions activated by Electric power and gas spring and cranks systems together
- ☆ At the head-end, there is a pair of push-handles, can be folded up and down
- ☆ Bright arrow symbols direct the users how to operate clearly
- ☆ Central-lock castors, diameter 150mm. Matched with direction castor, help the operator controlling the direction easily, Bed board for X-Ray Examination
- ☆ Hi-low range: 835mm-600mm
- ☆ Bck-rest lifting angle : 0-60°
- ☆ Knee-rest lifting angle: 0-40°
- ☆ Trendelenburg & Rev. Trendelenburg angle: 0-13°
- ☆ Packing: 1.12CBM/PC
- ☆ Net Weight: 105KGS



**SC-S11 Patient Trolley**

- ☆ Size: 1900\*630\*800mm
- ☆ Material: Quality stainless steel and PVC leather
- ☆ 5" castor with brake on the cross
- ☆ Equipped with I.V Stand



**SC-S12 Patient Trolley**

- ☆ Size: 1900\*630\*600-800mm
- ☆ Material: Quality stainless steel and PVC leather
- ☆ 5" castor with brake on the cross
- ☆ Equipped with I.V Stand



**SC-S21 2-Folding Stretcher**

- ☆ Size: 2050\*530\*130mm (Extend)
- ☆ 1020\*170\*80mm (Folded)
- ☆ Lightweight and durable Aluminum frame
- ☆ High quality canvas upholstery
- ☆ Colors available: Blue, Green, Black and Army Fashion
- ☆ Foldable design for easy carry and storage



**SC-S24 4-Folding Stretcher**

- ☆ Size: 2120\*550\*130mm (Extend)
- ☆ 5800\*140\*240mm (Folded)
- ☆ Lightweight and durable Aluminum frame
- ☆ High quality canvas upholstery
- ☆ Colors available: Blue, Green, Black and Army Fashion
- ☆ Foldable design for easy carry and storage



**SC-S31 Basket Stretcher**

- ☆ Size: 2160\*610\*190mm
- ☆ N.K.: 20KGS
- ☆ Max loading capacity: 160kgs



**SC-S33 Amulance Stretcher**

- ☆ Size: 1900\*550\*260mm
- ☆ Lightweight but heavy-duty frame with sponge cushion
- ☆ Safety-locking system to keep securit during using
- ☆ Foldabe design saved space and easily transport



**SC-S35 Amulance Stretcher**

- ☆ Size: 1940\*550\*480mm
- ☆ Lightweight and durable Aluminum frame with sponge cushion
- ☆ Adjustable headrest make more comfortable
- ☆ Easy push-handle on both of ends



**SC-C01 History Trolley**

- ☆ Size: 760\*585\*1010mm
- ☆ 42pcs case-history folder
- ☆ 1 bigger Drawer
- ☆ Central column locking system
- ☆ Luxurious 5" castor with brake on the cross



**SC-C03 Medicine Trolley**

- ☆ Size: 730\*690\*1010mm
- ☆ 60pcs medicine boxes (6 layers and 5pcs on double sides)
- ☆ 1pc garbage storage box
- ☆ Marble Top for durable and easily clean
- ☆ 5" castor with central locking system



**SC-C01S History Trolley**

- ☆ 25 layers with a drawer, 3" non-noise castor



**SC-C01D History Trolley (50pcs holder)**

- ☆ 50 layers with a drawer, 4" non-noise castor



**SC-C04A Medicine Trolley**



**SC-C04B Medicine Trolley, Double side**

- ☆ Size: 850\*520\*1010mm
- ☆ 6pcs drawers moveable from both sides
- ☆ 50pcs medicine boxes
- ☆ 2pcs garbage bin with lid and 1pc transparent file case
- ☆ 1pcs sliding side board and 1pc I.V pole with 5 hooks
- ☆ 5" castor with brake on the cross



**SC-C02 Medicine Trolley**

- ☆ Size: 760\*585\*1010mm
- ☆ 42pcs case-history folder
- ☆ 3 bigger Drawer and 6pcs small drawer
- ☆ 1pc garbage bin and plate
- ☆ Central column locking system
- ☆ Equipment with medicine box for different medicine storage
- ☆ Luxurious 5" castor with brake on the cross



**SC-C05 Emergency Trolley**

- ☆ Size: 850\*520\*1010mm
- ☆ 5pcs drawers (2 small, 2 middle and 1 big)
- ☆ 2pcs garbage bin with lid and 1pc transparent file case
- ☆ 1pc I.V. pole and 1pc Tray
- ☆ 5" castor with brake on the cross

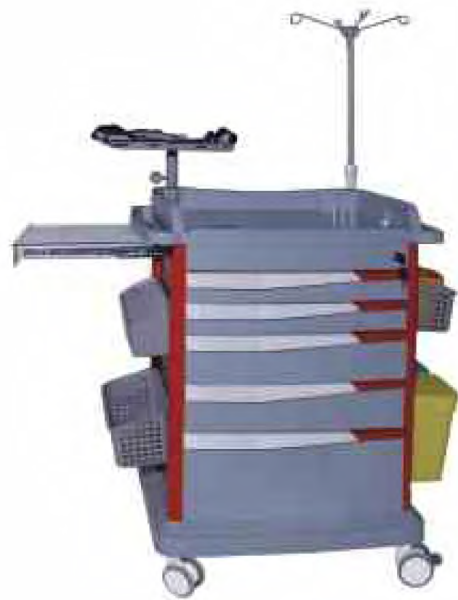

**SC-C06A Emergency Trolley**

- ☆ Specification: 850\*560\*1010mm
- ☆ ABS plastic top board with raised-edge design;
- ☆ Defibrillator shelf, storage box, utility basket,
- ☆ IV pole, Utility basket(inner with needle disposal holder), Dust basket;
- ☆ Oxygen tank holder; CPR board, power outlet&hooks;
- ☆ Centralized lock, 5 drawers(inner with dividers);
- ☆ Aluminum columns;
- ☆ 4 luxurious noiseless casters (two with brakes)



**SC-C06B Emergency Trolley**

- ☆ Specification: 780\*480\*1000mm
- ☆ ABS plastic top board with raised-edge design;
- ☆ Defibrillator shelf, storage box, utility basket,
- ☆ IV pole, Utility basket(inner with needle disposal holder), Dust basket;
- ☆ Oxygen tank holder; CPR board, Power outlet&hooks;
- ☆ 5 drawers(inner with dividers);
- ☆ 4 luxurious noiseless casters (two with brakes);



**SC-C08A Anaesthesia Trolley**

- ☆ High-strength alloy ABS boards
- ☆ Stainless steel guard rail
- ☆ Dust basket, File bin, Needle disposal holder
- ☆ Sliding side shelf
- ☆ Centralized lock
- ☆ Multi bin container
- ☆ 2 ABS drawers& Doors: 1 big, 1 small drawer each inner with partitions can be organized freely into different size units
- ☆ Four luxurious noiseless casters, two with brakes
- ☆ High-quality aluminum columns



**SC-C08B Anaesthesia Trolley**

- ☆ High-strength alloy ABS boards
- ☆ Centralized lock
- ☆ Dust basket, bumper protection Multi bin container
- ☆ Four luxurious noiseless casters, two with brakes
- ☆ High-quality plastic-steel columns 2 doors&2 ABS drawers: 1 small drawer, 1 big drawer each inner with partitions can be organized freely into different size units



**SC-C07A Hand Trolley (2 plate)**



**SC-C07B Hand Trolley (3 plate)**



**SC-C09A Infusion Trolley**

- ☆ One-piece ABS plastic top board with raised-edge design, covered transparent soft plastic glass, with four columns(C means: aluminum columns, D means: plastic -steel coumns.)1 drawer, inside with diciders can be organized easily and freely.IV.pole, dust basket, stainless steel guard rail, luxurious noiseless casters, two with brakes; label cardsfor drawers.



**SC-C09B Infusion Trolley**





**SC-C11 Dress Changing Trolley**  
★ 700\*460\*860mm



**SC-C12 Sector Trolley**  
★ Large: 1550\*460\*865mm  
★ Medium: 1400\*460\*865mm  
★ Small: 1200\*460\*865mm



**SC-VC01 Visitor Chair/Companion Chair**  
★ Steel Frame with powder-coating finish  
★ High density comfortable seat cushion  
★ 2150\*700\*600mm  
★ Removable castor for easily extend and foldable



**SC-C14 Instrument Trolley**  
★ 700\*460\*860mm



**SC-C15 Instrument Trolley**  
★ 700\*460\*860mm



**SC-C16 Instrument Trolley**  
★ Large: 800\*470\*865mm  
★ Medium: 670\*440\*865mm  
★ Small: 600\*420\*865mm



SC-CW02

**SC-CW01/2 Waiting Chair**  
★ Steel frame with chrome finish  
★ Molded backrest with air hole  
★ Seat Width: 670mm  
★ Seat Height: 440mm  
★ Back Height: 360mm  
★ Optional A: 2, 3 and 4 seats available  
★ Optional B: Padded seat and back



SC-CW01



**SC-C20 Anesthesia Trolley**  
★ Large: 550\*480\*860mm  
★ Small: 460\*400\*860mm



**SC-C22 Clean Trolley**  
★ A: Φ550\*800mm  
★ B: 550\*550\*800mm



**SC-C23 Clean Trolley**  
★ 1050\*475\*980mm



**SC-IC01 Infusion Chair**

- ★ Stainless steel Frame with I.V pole
- ★ High density upholstery make the seat more comfortable
- ★ Footstep for conveniently go up and down
- ★ Side holders for bag or bottle loading



**SC-IC04 Reclining Infusion Chair**

- ★ Metal frame with reclining design and I.V Pole
- ★ High density upholstery make the seat more comfortable
- ★ Wide wood armrest conveniently and comfortable to the patient
- ★ One handle-controller for lay down or seat up.



**SC-IC05 Infusion Chair**

- ★ Metal frame was powder-coated
- ★ High density upholstery make the seat more comfortable
- ★ Wide wood armrest conveniently and comfortable to the patient
- ★ One handle-controller for lay down or seat up



**SC-IC09 Infusion Chair**

- ★ Metal frame was powder-coated
- ★ High density upholstery make the seat more comfortable
- ★ Wide wood armrest conveniently and comfortable to the patient
- ★ 2, 3 and 4 seats available



SC-IV01 SC-IV02 SC-IV03

**SC-IV01 I.V. Stand**

- ★ 4 nylon castors provide for a smooth transport and maneuverability.
- ★ Removable hooks make this economy I.V. pole versatile.
- ★ Easily converted to 2 hook or 4 hook with easy to release push-pin.
- ★ Powder-coated steel with weighted base provides strength, durability and reduces risk of tipping

**SC-IV02 I.V. Stand**

- ★ Chrome-plated steel pole provides strength and durability.
- ★ Non-breakable composite 5-leg base and 5 swivel ball bearing casters provide easy, smooth maneuvering on all surfaces.
- ★ Easily converted to 2 hook or 4 hook with easy to release push-pin

**SC-IV03 I.V. Stand**

- ★ Chrome-plated steel pole provides strength and durability.
- ★ Non-breakable composite 5-leg base and 5 swivel ball bearing casters provide easy, smooth maneuvering on all surfaces.
- ★ Easily converted to 2 hook or 4 hook with easy to release push-pin



SC-MIS01 SC-MIS11

**SC-MIS01 Mayo Instrument Stand W/5 castors, Chrome Base**

**SC-MIS02 Mayo Instrument Stand W/5 castors, Nylon Base**

- ★ Castors provide additional mobility and convenience
- ★ Removable stainless steel tray in 490\*340\*25cm
- ★ Tray Height adjust from 736~1117mm with lock

**SC-MIS11 Mayo Instrument Stand, Single post with 2 castors**

**SC-MIS12 Mayo Instrument Stand, Single post with 4 castors**

- ★ Single post with "U" base design provides support and versatility
- ★ Removable stainless steel tray in 490\*340\*25cm
- ★ Tray Height adjust from 810~1270mm with lock
- ★ 2" nylon castor provides additional mobility



SC-MIS21 SC-MIS22

**SC-MIS21 Mayo Instrument Stand, Double post**

- ★ Double post provides added support for use in surgical procedures
- ★ Removable stainless steel tray in 490\*340\*25cm
- ★ Tray Height adjust from 860~1390mm with lock
- ★ 2" nylon castor provides additional mobility

**SC-MIS22 Mayo Instrument Stand**

- ★ Stainless steel frame with knock-down design
- ★ 600\*400mm Stainless steel Tray
- ★ 3" moveable castors
- ★ Size: L600XW400XH950~1300mm



**SC-MIS23 Mayo Instrument Stand**

- ★ Stainless steel frame with knock-down design
- ★ 450\*350mm Stainless steel Tray
- ★ 3" moveable castors
- ★ Size: L450XW350XH950-1300mm



**SC-WS01 Wash Stand, Single**

- ★ Stainless steel frame with knock-down design
- ★ Stainless steel Φ320mm basin
- ★ 3" moveable castors
- ★ Size: L445XW374XH735mm



**SC-WS02 Wash Stand, Double**

- ★ Stainless steel frame with knock-down design
- ★ Double Stainless steel Φ320mm basin
- ★ 3" moveable castors
- ★ Size: L840XW374XH735mm



**SC-W04S Foldable Ward Screen, Stainless Steel**



**SC-W04P Foldable Ward Screen, Power-coating**

- ★ 2, 3 and 4 panels available
- ★ Structure made from non-magnetic Stainless Steel tube
- ★ Folding panels, each 60cm wide
- ★ Fabric washable and flame retardant curtains for each section
- ★ Mobile on twin wheel swivel castors Φ50mm, for easy movement.
- ★ Knockdown Construction.
- ★ 3-folding Dimensions
- ★ Height : 175cm
- ★ Extended Width : 184cm
- ★ 4-folding Dimensions
- ★ Height : 175cm
- ★ Extended Width : 245cm



**SC-W05 Backrest**

- ★ Size: 63\*46\*61cm
- ★ Washable fabric with different colors available
- ★ 5-position adjustable
- ★ Comfortable small pillow



**SC-W05B Backrest**

- ★ Size: 63\*65\*61cm
- ★ Washable fabric with different colors available
- ★ 5-position adjustable
- ★ Comfortable small pillow



**SC-W06 Stepper**

- ★ 1, 2 and 3 steppers available
- ★ Metal frame with powder-coating, can be stainless steel
- ★ Solid pad with rubber cover against slide
- ★ Durable and non-slip rubber tips.



**SC-WS03 Wash Stand, Buckets**

- ★ Stainless steel frame with knock-down design
- ★ Φ230\*370mm Bucket with lid
- ★ Size: L840XW374XH735mm
- ★ Optional: one bucket, castors



**SC-KB01 Kick bucket, 350mm**



**SC-KB02 Kick Bucket, 1.2L**



**SC-DB01 Dust Bin, 8L, 10L, 12L, 20L, 25L**



SC-W07



SC-W08

**SC-W07A Stool W/Plastic Base**

**SC-W07B Stool W/Metal Base**

**SC-W08 Stool W/ Round Base**

- ★ High-density foam with PU leather
- ★ Height adjustable from 500-700mm



**SC-W09 Stool with Backrest**

- ★ Reinforced nylon base with 5 feet
- ★ Mobile on 5 twin wheel-swivel castors  $\Phi 50$  mm
- ★ Gas lift for height adjustment from 490 - 680 mm
- ★ Seat made from imitation leather upholstery with 50 mm thick high density foam padding
- ★ Knock down construction.



**SC-W12 Stool Stainless Steel**



**SC-W20 Pedal Exercise**



**SC-W20B Pedal Exercise (Digital display)**

- ★ Heavy-duty chrome steel frame
- ★ Smooth pedal movement
- ★ Non-slip rubber tips



**SC-OC01**

Oxygen Cart



**SC-OC02**

Oxygen Cart



**SC-OC03**

Oxygen Cart



**SC-OC04**

Oxygen Cart



**SC-AC01 Appliance Cupboard**

- ★ Constructed from Stainless steel
- ★ 2-lock-able glass door
- ★ 6-layer adjustable shelves
- ★ Elegant appearance.
- ★ Knock down construction.
- ★ Dimension: L900\*W400\*H1750mm



**SC-AC02 Appliance Cupboard**

- ★ Constructed from Stainless steel
- ★ 2-lock-able glass door
- ★ 2-lock-able drawers
- ★ 5-layer adjustable shelves
- ★ Elegant appearance.
- ★ Knock down construction.
- ★ Dimension: L900\*W400\*H1750mm



**SC-AC03 Appliance Cupboard**

- ★ Constructed from Stainless steel
- ★ 2-lock-able glass door
- ★ 4-layer adjustable shelves
- ★ Elegant appearance.
- ★ Knock down construction.
- ★ Dimension: L900\*W400\*H1750mm



**SC-AC04 Appliance Cupboard**

- ★ Constructed from enameled steel sheet
- ★ 2-lock-able glass door
- ★ 2-layer adjustable shelves
- ★ Elegant appearance.
- ★ Knock down construction.
- ★ Dimension: L900\*W400\*H1750mm



**SC-AC05 Appliance Cupboard**

- ★ Constructed from enameled steel sheet
- ★ 2-lock-able glass door
- ★ 4-layer adjustable shelves
- ★ Elegant appearance.
- ★ Knock down construction.
- ★ Dimension: L900\*W400\*H1750mm



**SC-AC06 Appliance Cupboard**

- ★ Constructed from enameled steel sheet
- ★ 2-lock-able glass door
- ★ 2-lock-able drawer
- ★ 3-layer adjustable shelves
- ★ Elegant appearance.
- ★ Knock down construction.
- ★ Dimension: L900\*W400\*H1750mm



M1



M3



**M1-M5**

- ☆ Standard Size: 1900\*900\*80mm
- ☆ Half Palm fiber + Half sponge
- ☆ Washable nylon cover

**M6 Alternating Pressure Mattress With Pump**

M6 is recommended for the prevention and treatment of pressure sore stage I and II in long-term and domiciliary therapies. The 9.5cm high cells in Nylon+PVC care particularly comfortable. And the pump can be hung to the end of bed by means of two hooks.

- ☆ Dimensions without flaps (L\*W\*H): 200\*86\*9.5cm
- ☆ Cell height: 9.5cm
- ☆ Nylon color: Jewelry blue
- ☆ Cell and base material: Nylon+PVC, 20cells+1 free spare cell
- ☆ Weight Support: 140kg
- ☆ Test Duration: 24hours
- ☆ Air output: 6-7L/min
- ☆ Warranty: 12months



P4000



M2



M4



M5

**M7 Bubble Mattress With Pump**

M7 is designed for the treatment and prevention of pressure sore stage I in short-term and domiciliary therapies. The mattress in PVC is composed of 7cm high bubble cells, particularly comfortable, it is fixed to the bed by extra flaps on both top and bottom side.

- ☆ Dimensions without flaps (L\*W\*H): 200\*90\*7cm
- ☆ Cell height: 7cm
- ☆ Cell and base material: TW NanYa EN71 Medical-Grade PVC, 130 cells
- ☆ Material thickness: 0.35mm
- ☆ Weight Support: 135kg
- ☆ Test Duration: 24hours
- ☆ Air output: 6-7L/min
- ☆ Warranty: 12months

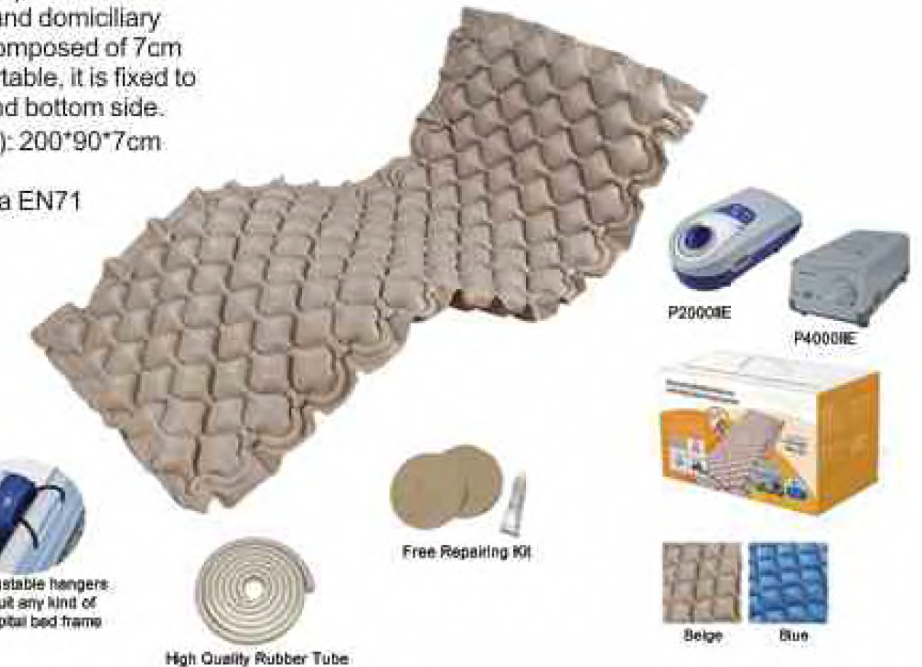

Adjustable hangers to suit any kind of hospital bed frame



High Quality Rubber Tube



Free Repairing Kit



Seige Bub



**SC-BR01**

- Bedrail with Padded Pouch  
Place on the side of bed to help getting up and down in bed, quick and tool free assembly Steel, Chrome-Plated, height adjust
- ☆ Overall Size: 17-21"H \* 20"W \* 7"D
  - ☆ Weight Capacity: 300LB=136KG
  - ☆ Packing size: 52.5\*8\*36cm, 1pc/box
  - ☆ 54.5\*49\*39.5cm, 5pcs/ctn
  - ☆ N.W: 2.1kg

**SC-BR02**

- Adjustable Height Home Bed Assist Handle  
Free tool, With Legs that reach the floor
- ☆ Height Adjustment: 15" - 20"
  - ☆ Rail Dimensions: 32.75" (D) x 19.75" (W) x 13.5-16.5" (H)
  - ☆ Weight Capacity: 250LB=115KG



**SC-BR03**

- Bedrail with Padded Pouch  
Place on the side of bed to help getting up and down in bed, quick and tool free assembly Steel, Powder-coated, height adjust
- ☆ Overall Size: 34-44"H \* 14"W \* 28"D
  - ☆ Weight Capacity: 250LB=115KG
  - ☆ Packing size: 46\*9\*40cm, 1pc/box
  - ☆ 51.5\*43\*48.5cm, 5pcs/ctn
  - ☆ N.W: 2.8kg

## Accessories

### Bed Head&Foot Board/Siderails

## Accessories

### Spare Part/Bed Board



SC-B92A Bed Head/Foot Board, 920mm



SC-B92B Bed Head/Foot Board, 920mm



SC-B92C Bed Head/Foot Board, 920mm



SC-75RS Side Rails



SC-75RM Side Rails



SC-75RL Side Rails



SC-KR01

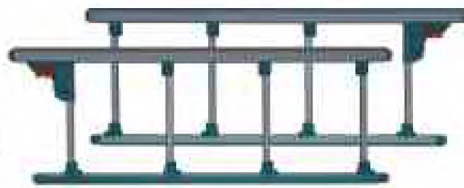

SC-95B



SC-130A

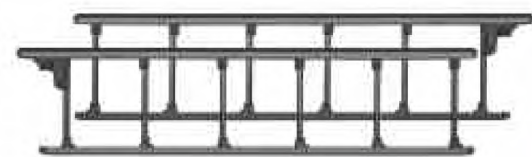

SC-150A

#### Side Rails, A-style

- ☆ Alluminum frame;
- ☆ ABS pushbutton
- ☆ Style :A
- Size: SC-95RA 950mm
- SC-130RA 1300mm
- SC-150RA 1500mm

#### Side Rails, B-style

- ☆ Alluminum frame;
- ☆ ABS pushbutton
- ☆ Style :B
- Size: SC-95RB 950mm
- SC-130RB 1300mm
- SC-150RB 1500mm



SC-B1  
☆ Chassis



SC-B2  
☆ Chassis



SC-B5  
☆ Food Board



SC-B10  
☆ Food Board



SC-B11  
☆ I.V.Pole



SC-B12  
☆ Crank



SC-B13  
☆ Baby Basin



SC-B14  
☆ Case-history Folder



SC-B15  
☆ Monkey Pole



SC-B16  
☆ Comer Bumpers

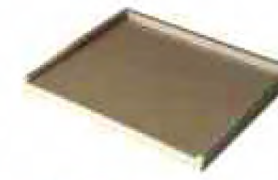

SC-B21  
☆ ABS Top to Cabinet



SC-B22  
☆ Spine Board



SC-B23  
☆ Head Immobilizer



SC-83S  
Soft Connection, 830mm



SC-83M  
Bed Surface, 830mm  
☆ 830\*710mm ☆ 830\*190mm  
☆ 830\*300mm ☆ 830\*630mm



SC-90S  
Soft Connection, 900mm



SC-90M1  
Bed Surface, 900mm  
☆ 900\*600mm ☆ 900\*410mm  
☆ 900\*190mm ☆ 900\*270mm



SC-90M2  
Bed Surface, 900mm  
☆ 900\*710mm ☆ 900\*190mm  
☆ 900\*300mm ☆ 900\*630mm



SC-92M  
Bed Surface, 920mm  
☆ 920\*680mm ☆ 920\*680mm  
☆ 920\*300mm



SC-77M  
Bed Surface, 770mm  
☆ 770\*670mm ☆ 770\*200mm  
☆ 770\*200mm ☆ 770\*370mm