



Medical



2020



Free Your Life

BE FREE
BE EASY
BE YOUR LIFE

Electric wheelchair

D03 D05 D06 D09 D10 D11 D12 D19 D20 DC01 Z01



Carbon Fiber

2020 NEW

P 1-20

Manual wheelchair

S001 S002 S003

P 21-26



2020 NEW

Folding scooter

FDB01 FDB02



2020 NEW

2020 NEW

P 27-30



Dot touch type lithium battery

Manual electric switching

Electric wheelchair

Electric wheelchair



Overall Size



940*630*950 mm

Fold Size



640*320*750 mm

Speed



0-6 km/h

Driving Range



20 km

Capacity



120 kgs

Weight



NW 21 kgs
GW 24 kgs

Gradient



0-8°

front



7"

rear



8"

Motor



24V 180W*2

Battery



24V 6AH * 2 pcs

Charger



24V 2A

Simple locking structure design for easy folding with single hand

Dot touch type lithium battery which is safe and convenient



Electric wheelchair

Product advantage

- Simple touch for folding and unfolding, quick and easy, compact folded size aluminum frame, lightweight and portable
- Alloy frame makes lightweight and easy to carry
- Detachable lithium ion battery for easy to take away, light and safe
- Armrest upward movement design for easy to mount on chair
- Low power consumption, low sound, maintenance free and powerful brushless motors



Electric wheelchair

Optional foot pedal



Overall Size 985*610*935 mm	Fold Size 610*290*810 mm	Speed km/h 0-6 km/h	Driving Range 20 km	Capacity 120 kgs	Weight NW 23.7 kgs GW 26.7 kgs
Gradient 0-8°	front 7"	rear 10"	Motor 24V 180W*2	Battery 24V 6AH * 2 pcs	Charger 24V 2A

- 09**
- 09B** Extra Width
- 09C** Backrest Angle Adjustable through Gas Spring

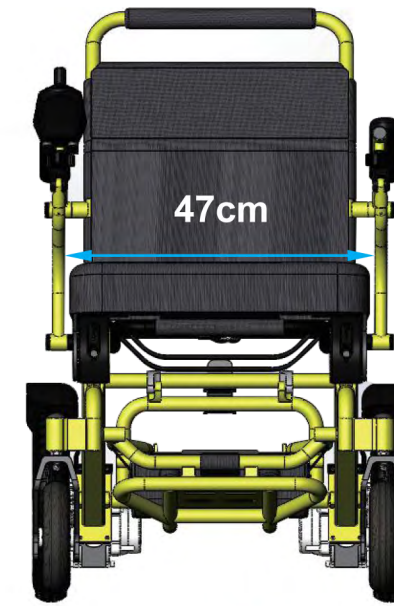

09

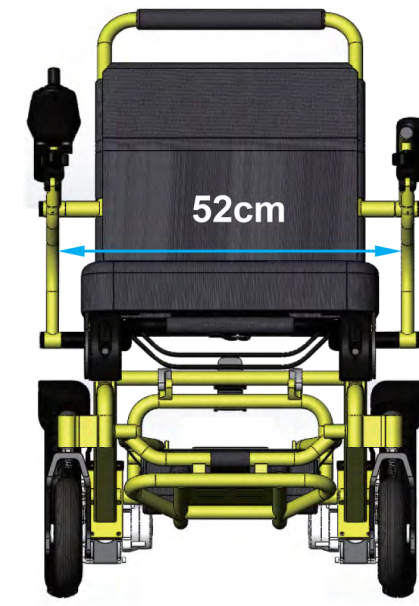

09B

Larger seat width design



Electric wheelchair

Electric wheelchair

Overall Size	Fold Size	Speed	Driving Range	Capacity	Weight
985*600*950 mm	600*355*790 mm	0-6 km/h	25 km	120 kgs	NW 25.1 kgs GW 28 kgs
Gradient	front	rear	Motor	Battery	Charger
0-8°	7"	12.5"	24V 250W*2	24V 6AH * 2 pcs	24V 2A

- Simple touch for folding and unfolding, quick and easy, compact folded size
- Alloy frame makes lightweight and easy to carry

- Detachable lithium ion battery for easy to take away, light and safe
- Armrest upward movement design for easy to mount on chair

10
10A
10B
10C
10D
10BD



Electric wheelchair



Detachable Battery



lithium battery (standard with two pcs 6AH)

Electric wheelchair

Product advantage

- Safe, Comfort and Light
- High strength magnesium alloy frame
- Apart from 24V 14AH standard battery, compatible with large capacity 28AH for longer distance driving



Overall Size



950*645*1040 mm

Fold Size



645*360*810 mm

Speed



0-6 km/h

Driving Range



16-32 km

Capacity



120 kgs

Weight



NW 25.6 kgs
GW 28.4 kgs

Gradient



0-8°

front



8"

rear



12.5"

Motor



24V 250W*2

Battery



24V 7AH * 2 pcs

Charger



24V 2A

10

10A

10B

10C

10D

10BD

Quick and easy battery in and out design

Extra Width (55cm)

Quick and easy battery in and out design. 2 sections backrest angle adjustable.

Backrest angle continuously adjustable

Extra Width (55cm)

11 Neckrest and backrest adjustable

11A



- One touch battery eject new design with anti-theft, quick and easy to remove features
- USD port for battery charge through mobile device
- Ergonomic seat for comfort



Electric wheelchair

Electric wheelchair



11A

Extra Width available

11

Neckrest and backrest adjustable

Extra Width available

Overall Size 985*658*1060 mm	Fold Size 658*355*820 mm	Speed 0-6 km/h	Driving Range 25 km	Capacity 120 kgs	Weight NW 26.8 kgs GW 29.9 kgs
Gradient 0-8°	front 7"	rear 12.5"	Motor 24V 250W*2	Battery 24V 6AH * 2 pcs	Charger 24V 2A

12
12 Extra Width



Product advantage

- Simple touch for folding and unfolding, quick and easy, compact folded size aluminum frame, lightweight and portable
- Alloy frame makes lightweight and easy to carry
- Detachable lithium ion battery for easy to take away, light and safe
- Armrest upward movement design for easy to mount on chair















Electric wheelchair

Electric wheelchair



Battery Removable

<p>Overall Size</p>  <p>1020*670*935 mm</p>	<p>Fold Size</p>  <p>670*370*760 mm</p>	<p>Speed</p>  <p>0-6 km/h</p>	<p>Driving Range</p>  <p>25 km</p>	<p>Capacity</p>  <p>120 kgs</p>	<p>Weight</p>  <p>NW 26.7 kgs GW 29.5 kgs</p>
<p>Gradient</p>  <p>0-8°</p>	<p>front</p>  <p>8"</p>	<p>rear</p>  <p>12.5"</p>	<p>Motor</p>  <p>24V 250W*2</p>	<p>Battery</p>  <p>24V 7AH * 2 pcs</p>	<p>Charger</p>  <p>24V 2A</p>

19
19A Transaxle and rear wheel section detachable



Detachable rear frame set design for easy to carry

Larger wheelbase for better stability



- Equipment with Motion motors and Dynamic controller for smooth and stable driving

- Easy touch button electric fold and unfold
- Ergonomic design provides more comfortable sitting position

Electric wheelchair

Electric wheelchair

<p>Overall Size</p> <p>1140*630*1020 mm</p>	<p>Fold Size</p> <p>630*500*810 mm</p>	<p>Speed</p> <p>0-6 km/h</p>	<p>Driving Range</p> <p>20 km</p>	<p>Capacity</p> <p>120 kgs</p>	<p>Weight</p> <p>NW 36.9 kgs GW 39.9 kgs</p>
<p>Gradient</p> <p>0-8°</p>	<p>front</p> <p>8"</p>	<p>rear</p> <p>12.5"</p>	<p>Motor</p> <p>24V 200W*2</p>	<p>Battery</p> <p>24V 6AH * 2 pcs</p>	<p>Charger</p> <p>24V 2A</p>



NW **22** kgs

Aluminum Alloy

Light composite motor



Electric wheelchair

Electric wheelchair

<p>Overall Size</p> <p>955*670*920 mm</p>	<p>Fold Size</p> <p>670*335*760 mm</p>	<p>Speed</p> <p>0-6 km/h</p>	<p>Driving Range</p> <p>25 km</p>	<p>Capacity</p> <p>120 kgs</p>	<p>Weight</p> <p>NW 22 kgs</p>
<p>Gradient</p> <p>0-8°</p>	<p>front</p> <p>7"</p>	<p>rear</p> <p>8"</p>	<p>Motor</p> <p>24V 250W*2</p>	<p>Battery</p> <p>24V 6AH * 2 pcs</p>	<p>Charger</p> <p>24V 2A</p>

- Aluminum Alloy frame with weight only 22 kgs
- Simple locking structure design for easy folding with single hand

- Brand new design with better look and fashion
- New folding mechanism makes lighter weight and more compact

CO1



NW **18** kgs

Carbon fiber

Light composite motor



Electric wheelchair

Electric wheelchair

Overall Size 955*670*920 mm	Fold Size 670*335*760 mm	Speed 0-6 km/h	Driving Range 25 km	Capacity 120 kgs	Weight NW 18 kgs
Gradient 0-8°	front 7"	rear 8"	Motor 24V 250W*2	Battery 24V 6AH * 2 pcs	Charger 24V 2A

- Carbon fiber frame with weight only 18 kgs
- Brand new design with better look and fashion
- Simple locking structure design for easy folding with single hand
- New folding mechanism makes lighter weight and more compact



Electric wheelchair

Standing & Lying

30 km

Driving Range



Electric wheelchair

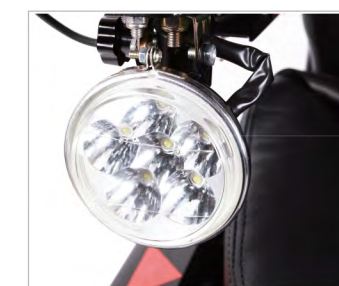

Overall Size 1120*660*1040 mm	Lying And Stanging Size 1700mm	Speed 0-6 km/h	Driving Range 30 km	Capacity 125 kgs	Weight 124 kgs
Gradient 0-8°	front 18"	rear 2.5"	Motor 24V 960W	Battery 24V 20AH * 4 pcs	Charger 24V 2A

- Electric standing for easy to reach higher position
- Equipped with Motion motor and PG controller for smooth and stable driving
- large capacity 24V 24 V for longer distance driving
- Luxury automobile seat for extra comfort



13 kgs



Manual wheelchair

Manual wheelchair

Overall Size 1085*690*920 mm	Fold Size 830*300*770 mm	Seat High 460 mm	Seat Depth 400 mm	Armrest High 220 mm	Battery charger /
Gradient 0-8°	front 7"	rear 24"	Capacity 100kg	Weight 13 kgs	Charger /

- Footrest up and down adjustable Whole unit foldable
- Adjustable backrest

- Front and back non-pneumatic PU tire is anti-puncture and durable.
- Standing hand brake



Manual wheelchair



12 kgs



Manual wheelchair

Overall Length



80 cm

Overall Width



54/56/58/60 cm

Overall Height



75 cm

Fold width



32 cm

Seat Width



36/38/40/42 cm

Seat Depth



38/40/42 cm

Seat Height



39-43 cm

Backrest Height



35-40 mm

Front



4"

Rear



24"

Capacity



100 kgs

Weight



12 kgs

High value-cost sport model

streamlined design

Foldable and easy to carry

22" Quick release tire

NW **5.5** kgs



Manual wheelchair

Manual wheelchair

Overall Size 640*435*830 mm	Fold Size 190*435*535 mm	Seat High 390 mm	Seat Depth 340 mm	Backrest High 350 mm	Battery charger /
Gradient 0-8°	front 3"	rear 5"	Capacity 125 kgs	Weight 5.5 kgs	Charger /



Aviation level Alloy frame which is super light for easy to carry

Very compact folded size allow to be carried into aircraft

DB01

Electric Folding Scooter



Electric Folding Scooter



<p>Overall Size</p>  <p>1050*550*870 mm</p>	<p>Fold Size</p>  <p>480*550*790 mm</p>	<p>Speed</p>  <p>0-6 km/h</p>	<p>Driving Range</p>  <p>25 km</p>	<p>Capacity</p>  <p>120 kg</p>	<p>Weight</p>  <p>NW 26.5 kgs GW 29 kgs</p>
<p>Gradient</p>  <p>0-8°</p>	<p>Front</p>  <p>7"</p>	<p>Rear</p>  <p>8"</p>	<p>Motor</p>  <p>24V 180W</p>	<p>Battery</p>  <p>24V 6AH * 2 pcs</p>	<p>Charger</p>  <p>24V 2A</p>

○ Electric folding and unfolding switch

○ Equipped with Motion motor and PG controller for smooth and stable driving

○ Full Alloy frame for lighter weight

○ Dot touch type lithium battery which is safe and convenient

DB02



Electric Folding Scooter

Electric Folding Scooter



<p>Overall Size</p> <p>980*490*800 mm</p>	<p>Fold Size</p> <p>390*490*720 mm</p>	<p>Speed</p> <p>0-6 km/h</p>	<p>Driving Range</p> <p>25 km</p>	<p>Capacity</p> <p>120 kg</p>	<p>Weight</p> <p>NW 26 kgs GW 28.5 kgs</p>
<p>Gradient</p> <p>0-8°</p>	<p>Front</p> <p>6.5"</p>	<p>Rear</p> <p>7.5"</p>	<p>Motor</p> <p>24V 270W</p>	<p>Battery</p> <p>24V 6AH * 2 pcs</p>	<p>Charger</p> <p>24V 2A</p>

- Electric folding and unfolding switch
- Equipped with Motion motor and PG controller for smooth and stable driving
- Compact folded size due to new design folding mechanism
- Full Alloy frame for lighter weight
- Dot touch type lithium battery which is safe and convenient
- Seat comes with sensor switch in case accidental fault on remote against damage
- Manual folding and unfolding

BE FREE

BE EASY

BE YOUR LIFE

— —
Free Your Life

