

LES NOUVEAUX EXPORTATEURS LIMITED
Office 3,10/F WITTY COMMERCIAL BUILDING,
1A-1L TUNG CHOI STREET,MONGKOK QUARTER
KOWLOON,HONG KONG

Office:+852 8191 1210

Whatsapp&mobile: +63 915 904 4401

www.lesnouveauxexportateurs.fr

<https://www.youtube.com/@lesnouveauxexportateurs2090/videos>

ericcaux@lesnouveauxexportateurs.fr



FURNITURE



Dreamevent

HOTEL & WEDDING

Furniture Manufacture For
Hotel And Banquet

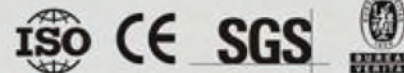

Index

目录



01-10

Chiavari chair series
竹节椅系列



11-18

Plastic chair series
塑料椅系列



19-26

Banquet chair series
宴会椅系列



27-28

Flex back chair series
展背椅系列



29-32

Church chair series
教堂椅系列



33-40

Wood imitated chair series
仿木椅系列



41-42

Leisure chair series
休闲椅系列



43-44

High bar chair series
酒吧椅系列



45-46

kids' chair series
儿童椅系列



47-52

Stainless steel chair series
不锈钢椅系列



53-56

Stainless steel table series
不锈钢桌系列



57-62

Folding table & chair series
折叠桌椅系列



63-70

Booth & sofa series
卡座/沙发椅系列



71-84

Linen series
布罩椅系列



85-94

Table series
宴会餐桌系列



95-107

Other supporting series
宴会配套系列

CHIAVARI CHAIR SERIES 竹节椅系列

HOTEL & WEDDING FURNITURE



9ZJ01 
800 300 410 440 9-11



9ZJ02 
800 300 410 440 9-11



9ZJ03 
800 300 410 440 9-11



9ZJ04 
800 300 410 440 9-11



9ZJ05 
100 300 410 440 9-11



9ZJ06 
100 300 400 400 9-11



9ZJ07 
100 400 400 400 9-11



9ZJ08 
100 400 400 400 9-11



9ZJ09 
100 300 420 430 9-11



9ZJ10 
100 300 420 430 9-11



9ZJ11 
100 300 420 470 5



9ZJ12 
100 300 470 400 5



9ZJ13 
100 300 400 400 5



9ZJ14 
100 420 400 440 5



9ZJ15 
940 300 440 440 9-11



9ZJ16 
800 300 400 440 9-11



9ZJ19 
860 300 400 420 9-11



9ZJ20 
860 370 430 440 9-11



9ZJ21 
800 360 420 440 10-12



9ZJ17 
820 300 450 440 9-11



9ZJ18 
800 300 440 440 9-11



9ZJ22 
840 410 450 450 9-11



9ZJ23 
1020 420 430 480 9-11



9ZJ24 
1000 300 420 470 9-11



9ZJ25 
95 370 400 400 9-11



9ZJ26 
85 375 400 400 9-11



9ZJ27 
100 370 400 400 9-10



9ZJ28 
100 370 400 400 9-10



9ZJ29 
90 375 415 400 9-11



9ZJ30 
90 370 415 400 9-11



9ZJ31 
90 360 440 440 9



9ZJ32 
90 380 415 400 9-11

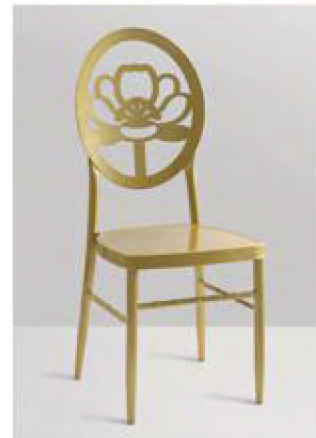

9ZJ33 
90 375 410 405 9-11



9ZJ34 
95 370 420 400 9-11



9ZJ35
606 375 420 430 9-11



9ZJ36
940 380 425 440 9-11



9ZJ37
960 380 425 430 9-11



9ZJ44
890 370 420 440 9-11



9ZJ45
600 380 390 440 9-11



9ZJ46
980 400 400 440 9-11



9ZJ38
990 380 410 430 10-12



9ZJ39
990 375 425 430 10-12



9ZJ40
970 380 420 445 10-12



9ZJ47



9ZJ48



9ZJ49



9ZJ41
950 380 440 460 5



9ZJ42
940 430 460 460 9-11



9ZJ43
935 420 470 460 9-11





Transparent Color



Opaque Color



9SL01
800 370 400 450 10-12



9SL02
800 370 400 450 10-12



9SL03
800 370 400 450 10-12



9SL04
800 370 400 450 10-12



9SL05
940 370 420 450 10-12



9SL06
900 370 420 450 10-12



9SL09
1200 370 450 700 4



9SL10
1200 370 450 700 4



9SL11
1100 360 480 700 4



9SL07
940 370 420 450 10-12



9SL08
940 370 420 450 10-12

Many colors are optional





9SL12
900 500 900 400 5-6



9SL13
900 570 500 400 5-6



9SL18
900 400 500 400 5-6



9SL19
900 500 400 400 5-6



9SL20
810 400 400 400 1



9SL14
900 300 470 400 5-6



9SL15
900 500 400 470 5-6



9SL21



9SL22



9SL16
880 400 510 400 5-6



9SL17
800 400 510 400 5-6



9SL23



9SL24



9SL25
800 300 440 400 10-12



9SL26
940 400 410 400 10-12



9SL27
800 300 410 400 10-12



9SL34
670 430 625 5-10



9SL35
800 525 500 5-10



9SL36
870 520 570 5-10



9SL28
800 400 470 10-12



9SL29
940 400 470 400 10-12



9SL30
970 400 400 450 10-12



9SL37
820 520 420 5-10



9SL38
815 440 415 5-10



9SL39
820 475 430 5-10



9SL31
970 400 400 450 10-12



9SL32
940 400 400 400 10-12



9SL33
970 405 520 450 10-12



9SL40
785 450 400 5-10



9SL41
830 530 465 5-10



9SL42
820 450 400 5-10

BANQUET CHAIR SERIES 宴会椅系列

HOTEL & WEDDING FURNITURE



9YH01 
320 400 520 400 14-16



9YH02 
320 450 520 400 14-16



9YH03 
320 440 520 400 14-16



9YH04 
325 440 500 400 14-16



9YH05 
320 450 515 400 14-16



9YH06 
310 445 510 400 14-16



9YH07 
300 400 520 450 14-16



9YH08 
300 400 520 450 14-16



9YH11 
370 400 520 450 14-16



9YH12 
300 400 520 450 14-16



9YH09 
310 430 500 450 14-16



9YH10 
300 430 500 450 14-16



9YH13 
300 400 510 450 14-16



9YH14 
300 400 515 450 14-16



9YH15 300 455 450 470 14-16



9YH16 310 400 390 450 14-16



9YH17 340 470 390 450 14-16



9YH18 310 470 390 450 14-16



9YH19 300 400 420 440 14-16



9YH20 300 400 390 440 14-16



9YH21 300 400 390 440 14-16



9YH22 370 400 390 440 14-16



9YH23 300 400 390 440 14-16



9YH24 300 400 390 440 14-16



9YH25
100 440 500 400 14-16



9YH26
940 420 515 440 14-16



9YH27
820 400 520 400 14-16



9YH28
100 440 500 400 14-16



9YH29
940 400 500 400 14-16



9YH30
820 440 500 400 14-16



9YH31
805 435 510 400 14-16



9YH32
820 440 500 405 14-16



9YH33
820 440 500 405 14-16



9YH34
820 430 500 400 14-16



9YH35
820 430 500 400 14-16



9YH36
910 430 500 400 14-16



9YH37
800 430 500 400 14-16



9YH38
820 430 500 400 14-16



9YH39
820 450 520 400 14-16



9YH40
600 400 500 400 14-16



9YH41
600 520 450 400 14-16



9YH42
560 440 500 400 14-16



9YH46
915 430 525 450 6



9YH47
600 520 450 450 6



9YH48
600 425 540 400 6



9YH43
665 400 500 405 6



9YH44
640 400 500 400 6



9YH45
600 400 500 400 6



9YH49
675 475 580 475 6



9YH50
600 425 530 400 6



9YH51
600 555 570 475 6



9YH52
910 620 670 400 6



9YH53
910 620 670 400 6



9YH54
600 500 600 400 6

CHURCH CHAIR SERIES 教堂椅系列

HOTEL & WEDDING FURNITURE



Church chair series
教堂椅系列



9JT01 
600 400 540 440 61-0



9JT02 
670 500 590 440 61-0



9JT03 
600 456 500 440 61-0



9JT04 
600 470 540 470 61-0



9JT05 
870 520 500 400 8-9



9JT06 
870 500 500 400 8-9



9JT11 
780 550 510 400 8-7



9JT12 
900 470 510 470 8-9



9JT07 
900 510 540 400 8-9



9JT08 
900 510 540 400 8-9



9JT13 
880 460 540 470 8-9



9JT14 
910 445 510 400 15-17



9JT09 
920 480 540 470 8-9



9JT10 
900 480 520 400 8-9



9JT15 
900 750 250 400 1



9JT16 
900 530 500 470 1



9JT17 
900 750 250 400 1



9FM05 
970 440 500 480 6



9FM06 
960 400 500 480 6



9FM07 
980 480 520 480 6



9FM14 
900 420 500 480



9FM15 
980 450 480 480



9FM16 
900 500 540 480



9FM08 
980 460 480 480 6



9FM09 
1000 480 480 480 6



9FM10 
900 480 480 470 6



9FM17 
985 445 480 480



9FM18 
900 420 480 480



9FM19 
970 400 470 440



9FM11 
980 440 480 480 6



9FM12 
980 440 480 480 6



9FM13 
980 440 480 480 6



9FM20 
980 440 480 480 6



9FM21 
980 440 480 480 6



9FM22 
980 440 480 480 6



9FM05
970 440 500 480 6



9FM06
960 400 500 480 6



9FM07
960 480 520 480 6



9FM14
900 420 500 480



9FM15
980 450 480 480



9FM16
900 500 540 480



9FM08
980 460 480 480 6



9FM09
1000 480 480 480 6



9FM10
900 480 480 470 6



9FM17
885 445 480 480



9FM18
900 420 480 480



9FM19
970 400 470 440



9FM11
900 470 480 500 6



9FM12
945 470 440 480 6



9FM13
960 480 500 480 6



9FM20
770 500 500



9FM21
770 500 500



9FM22
735 540 480



9FM23
900 570 620



9FM24
870 300 630 0



9FM25
940 450 480 480 0



9FM30
800 480 530 480 2



9FM31
570 415 475 480 6



9FM32
620 470 470 0



9FM26
800 460 470 470 6



9FM27
940 435 480 470 6



9FM28
970 450 500 470 6



9FM33
800 570 540 440 1



9FM34
530 475 500 480 6



9FM35
880 480 470 620 6



9FM29
1000 510 615 470 6



9FM36
820 450 480 480 6



9FM37
1000 450 500 480 6



9FM38
990 480 470 470 6



9FM39
640 575 500 450 1



9FM40
600 500 500 450 2



9FM41
600 470 600 450 4



9FM45
900 465 510 450 6



9FM46
600 500 450 470 4



9FM47
1000 550 500 470 4



9FM42
670 480 640 480 1



9FM43
1070 480 500 480 6



9FM44
1000 470 500 480 2



9FM48
700 580 500 470 2



9FM49
670 480 500 470 2



9FM50
1000 550 500 480 2





9XX01
830 405 440



9XX02
840 400 470



9XX07
800 440 440



9XX08
720 400 440



9XX09
850 400 400



9XX03
600 405 465 445



9XX10

Height/高度:
18" : 45cm
24" : 61cm
26" : 66cm
30" : 76cm



9XX04
600 500 480



9XX05
600 500 480



9XX06
680 580 620



9XX11
850 440 440
1100 450 440



9XX12
850 440 440

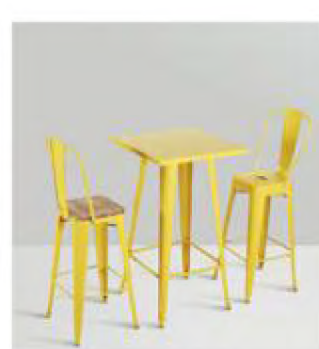

9XX13
1100 450 440



9BY01
1000 380 470 700



9BY02
1170 380 440 700



9BY03
1000 420 500



9BY10
800 480 410



9BY11
800 420 440 700



9BY12
1200 400 480 750



9BY04
1170 410 510 700



9BY05
1150 530 420 700



9BY06
1305 380 500 740



9BT01



9BT02



9BT03



9BT04



9BY07
910 410 450



9BY08
1000 420 500 700



9BY09
1100 420 520 700



9BT05



9BT06



9BT07



9ET01
400 500 500 1



9ET02
800 400 440 500 1



9ET03
700 300 350 500 1



9ET04
520 200 300 300 10



9ET05
510 300 310 330 5



9ET06
800 400 540 500 1



9ET07
690 310 370 380 6



9ET08
610 300 300 320 8



9ET09
640 300 300 350 4



9ET10
690 340 340 320 4



9ET11
625 305 345 325 15



9ET12
625 380 310 320 10



9ET13



9ET14



9ET15



9ET16



9ET17



9ET18

<p>成人</p> <p>700x450x920mm</p>	<p>中学</p> <p>700x450x800mm</p>	<p>小学</p> <p>630x440x750mm</p>	<p>学前班</p> <p>580x410x650mm</p>
<p>大班</p> <p>580x380x600mm</p>	<p>中班</p> <p>520x370x550mm</p>	<p>小班</p> <p>510x350x500mm</p>	<p>托班</p> <p>490x300x450mm</p>

STAINLESS STEEL TABLE & CHAIR SERIES 不锈钢桌椅系列

HOTEL & WEDDING FURNITURE



9BX01
940 440 570 400 2-4



9BX02
830 470 500 440 2-4



9BX03
880 370 410 430 2-4



9BX04
870 400 540 400 2-4



9BX05
880 400 400 400 2-4



9BX06
100 470 500 400 2-4



9BX07
900 470 520 400 2-4



9BX08
900 470 520 400 2-4



9BX15
110 540 600 400 2-4



9BX16
900 440 450 400 2-4



9BX17
900 420 470 400 2-4



9BX09
990 460 480 450 2-4



9BX10
990 470 520 400 2-4



9BX11
900 370 410 400 2-4

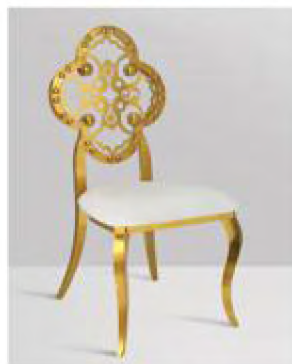

9BX18
1000 470 450 470 2-4



9BX19
940 470 450 470 2-4



9BX20
1180 500 500 400 1



9BX12
940 480 520 470 2-4



9BX13
1100 480 520 470 2-4



9BX14
1100 480 600 520 2-4



9BX21
1100 485 400 400 2-4



9BX22
1070 480 500 470 2-4



9BX23
1000 480 520 470 2-4



98X24
800 440 470 400 2-4



98X25
1100 400 500 470 2-4

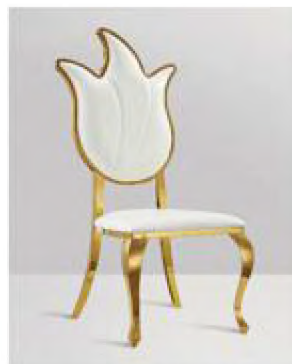

98X26
1000 500 500 470 2-4



98X33
1140 400 510 400 2-4



98X34
1100 400 500 470 2-4



98X35
980 470 600 400 2-4



98X27
1020 400 540 400 2-4



98X28
1110 540 600 400 1



98X29
1000 400 540 400 2-4



98X36
980 300 400 400 2-4



98X37
980 500 500 400 1



98X38
1000 470 600 400 2-4



98X30
1150 400 510 400 2-4



98X31
1040 400 500 470 2-4



98X32
900 400 520 400 2-4



98X39
700 510 400 470 1



98X40
670 380 400 470 2-4



98X41
820 430 400 400 2-4



9BX42



9BX43



9BX50



9BX51



9BX52



9BX44



9BX45



9BX46



9BX53



9BX54



9BX47



9BX48



9BX49



9BX55



9BX56



9BX57



9BX58



9BX63



9BX64



9BX65



9BX59



9BX60



9BX66



9BX67



9BX68



9BX61



9BX62

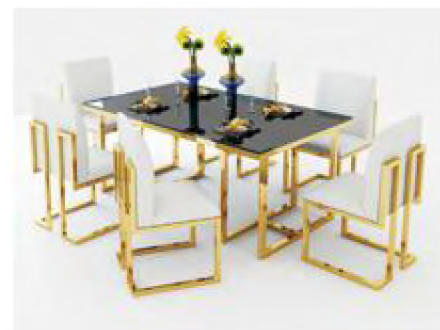

9BX69



9BX70

FOLDING TABLE & CHAIR SERIES 折疊桌椅系列

HOTEL & WEDDING FURNITURE



9ZD01 
 770 500 530



9ZD02 
 775 445 420



9ZD03 
 835 450 450



9ZD04 
 770 460 470



9ZD05 
 785 445 440



9ZD06 
 875 460 530



9ZD07 
 840 445 520



9ZD08 
 870 460 520



9ZD09 
 870 460 520



9ZD10   
 840 490 515



9ZD11   
 840 475 520



9ZD12   
 860 470 530





9ZD19   
 800 400 400



9ZD20   
 400 300 300



9ZD21   
 1130 480 470



9ZD13   
 860 400 520



9ZD14   
 860 470 530



9ZD15    折叠:  
 850 480 350 1000 480



9ZD22
 Dia. 800x1100(H)mm



9ZD23
 Dia. 680x1170(H)mm



9ZD24
 Dia. 600x1080(H)mm





9ZD16   
 875 445 450



9ZD17   
 790 470 400



9ZD18   
 800 400 400





9ZD25 1220(L)×610(W)×740(H)mm



9ZD26 1220(L)×610(W)×740(H)mm



9ZD31 Dia. 1100×740(H)mm
Dia. 1200×740(H)mm
Dia. 1500×740(H)mm
Dia. 1600×740(H)mm
Dia. 1800×740(H)mm
Dia. 2000×740(H)mm



9ZD32 Dia. 1200×740(H)mm
Dia. 1500×740(H)mm
Dia. 1800×740(H)mm



9ZD27 1520(L)×760(W)×740(H)mm
1620(L)×710(W)×740(H)mm
1830(L)×760(W)×740(H)mm
2000(L)×900(W)×740(H)mm
2440(L)×760(W)×740(H)mm



9ZD28 1520(L)×760(W)×740(H)mm
1830(L)×760(W)×740(H)mm
2440(L)×760(W)×740(H)mm



9ZD33 Dia. 600×740(H)mm
Dia. 800×740(H)mm



9ZD34 760(L)×500(W)×350-715(H)mm
660(L)×500(W)×530-690(H)mm



9ZD29 1800(L)×450(W)×740(H)mm



9ZD30 880(L)×880(W)×740(H)mm



9ZD35 1830(L)×250(W)×440(H)mm
1830(L)×280(W)×440(H)mm



9ZD36 T: 1050(L)×640(W)×730(H)mm
C: 845(L)×200(W)×400(H)mm

BOOTH & SOFA SERIES 沙发椅系列

HOTEL & WEDDING FURNITURE



9SF01



9SF02



9SF03



9SF04



9SF05



9SF06



9SF07



9SF08



9SF09



9SF10



9SF15



9SF16



9SF11



9SF12



9SF17



9SF18



9SF13



9SF14



9SF19



9SF20



9SF21

800(W) x 600(D) x 1250(H) mm



9SF22

940(W) x 780(D) x 1780(H) mm



9SF23

1750(W) x 880(D) x 1820(H) mm



9SF30

650(W) x 600(D) x 1400(H) mm



9SF31

650(W) x 600(D) x 1400(H) mm



9SF32

750(W) x 700(D) x 1400(H) mm



9SF24

900(W) x 700(D) x 1780(H) mm



9SF25

650(W) x 660(D) x 1800(H) mm



9SF26

820(W) x 670(D) x 1590(H) mm



9SF33

1180(W) x 600(D) x 1650(H) mm



9SF34

700(W) x 680(D) x 1780(H) mm



9SF35

950(W) x 760(D) x 1700(H) mm



9SF27

630(W) x 540(D) x 1150(H) mm



9SF28

680(W) x 700(D) x 1125(H) mm



9SF29

650(W) x 500(D) x 1220(H) mm



9SF36

680(W) x 680(D) x 1500(H) mm



9SF37

720(W) x 720(D) x 1650(H) mm



9SF38

840(W) x 630(D) x 1720(H) mm



9SF39

1200(W) x 850(D) x 1250(H) mm



9SF40

1750(W) x 850(D) x 1250(H) mm



9SF47

2000(W) x 830(D) x 1130(H) mm



9SF48

1800(W) x 780(D) x 1250(H) mm



9SF41

2200(W) x 850(D) x 1250(H) mm



9SF42

2050(W) x 980(D) x 1380(H) mm



9SF49

1900(W) x 850(D) x 1050(H) mm



9SF50

2200(W) x 800(D) x 1050(H) mm



9SF43

1200(W) x 900(D) x 1500(H) mm



9SF44

1750(W) x 900(D) x 1500(H) mm



9SF51

1680(W) x 850(D) x 1000(H) mm



9SF52

450(W) x 450(D) x 450(H) mm



9SF45

1600(W) x 850(D) x 1200(H) mm



9SF46

2000(W) x 850(D) x 1000(H) mm



9SF53

1200(W) x 450(D) x 450(H) mm



9SF54

1200(W) x 450(D) x 450(H) mm

LINEN
SERIES 布草系列

HOTEL & WEDDING FURNITURE



98C01



98C02



98C03



98C04



98C05



98C06



98C07



98C08



98C13



98C14



98C09



98C10



98C15



98C16



98C11



98C12



98C17



98C18



9BC19



9BC20



9BC21



9BC22



9BC23



9BC24



9BC25



9BC26



9BC27



9BC28



9BC29



9BC30



9BC31



9BC32



9BC33



9BC34



9BC35



9BC40



9BC41



9BC36



9BC37



9BC42



9BC43



9BC38



9BC39



9BC44



9BC45



98C46



98C47



98C48



98C55



98C56



98C57



98C49



98C50



98C51



98C58



98C59



98C60



98C52



98C53



98C54



98C61



98C62



98C63



9BC64



9BC65



9BC66



9BC67



9BC68



9BC69



9BC70



9BC71



9BC72



9BC73



9BC74



9BC75



9BC76



9BC77



9BC78



9BC79



9BC80



9BC81



9BC82



9BC83 Satin



9BC84 Polyester



9BC85 Polyester



9BC86 Cotton



9BC87 Flax



9BC88 Cotton & Polyester



9BC89



9BC90



9BC91



9BC92



9BC93



9BC94



9BC95



9BC96



9BC97



9BC98



9BC99



9BC100



9BC101



9BC102



9BC103



9BC104



9BC105



9BC106



9BC107



9BC108



9BC109



9BC110



9BC111

BANQUET TABLE SERIES 宴会餐桌系列

HOTEL & WEDDING FURNITURE



9CZ01 组合台
(多功能组合桌可按客户大小规格定做)



多功能组合摆设 (参考) The layouts for Multifunction Compound Table(FOR YOUR INFORMATION)

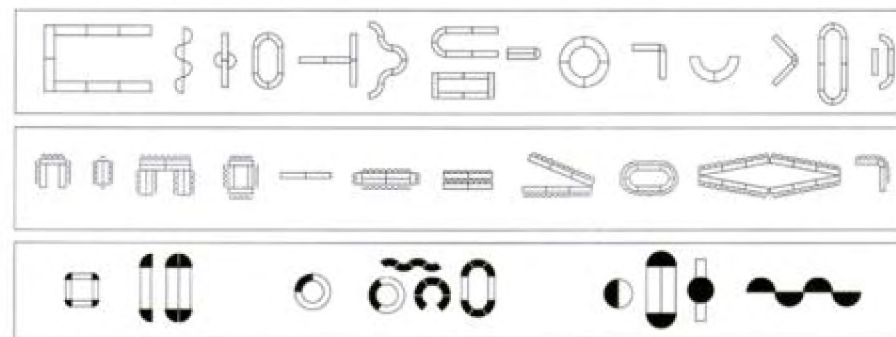

台规格及座位数 (参考) Recommended table size and Capacity

台尺寸
Table size
18"x48"2人, Persons
18"x60"2人, Persons
18"x72"3人, Persons
18"x96"4人, Persons
30"x48"4人, Persons
30"x60"5人, Persons
30"x72"8人, Persons
30"x96"10人, Persons

42"直径dia.4人, Persons
48"直径dia.6人, Persons
54"直径dia.8-9人, Persons
60"直径dia.8-10人, Persons
66"直径dia.10人, Persons
72"直径dia.10-12人, Persons

宴会组合每椅位客人需留21英寸空间。
你的台尺寸计算方式如下:

直径 (英寸) x 21英寸 = 座位数

直径

TO KNOW THE SIZE OF THE BANQUET ROUND TABLE YOU NEED, ASSUME 21" SPACE FOR EACH PERSON. PLEASE USE THE FOLLOWING FORMULA FOR CALCULATION:

DIAMETER (IN) x 21" = SEATING CAPACITY

DI"

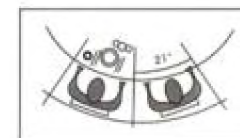

图例说明/Description

- | | | | |
|---------------------|-----------------|--------------|-------|
| ①中心圆台/center | 可座12人/12persons | 1圆组合1table | φ72" |
| ②第二环/second annulus | 可座24人/24persons | 4圆组合4table | φ144" |
| ③第三环/third annulus | 可座36人/36persons | 8圆组合8table | φ216" |
| ④第四环/fourth annulus | 可座48人/48persons | 10圆组合10table | φ288" |
| ⑤第五环/fifth annulus | 可座60人/60persons | 12圆组合12table | φ360" |

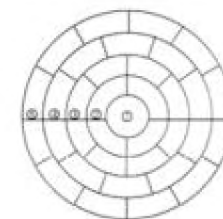



9CZ02
 φ1200×760(H)mm
 φ1500×760(H)mm
 φ1600×760(H)mm
 φ1800×760(H)mm
 φ2000×760(H)mm



9CZ03
 φ2800×760(H)mm
 φ3000×760(H)mm
 φ3200×760(H)mm
 φ3500×760(H)mm



9CZ08
 760(L) X 760(W) X 760(H)mm
 910(W) X 910(D) X 760(H)mm



9CZ09
 760(L) X 760(W) X 760(H)mm
 910(L) X 910(W) X 760(H)mm



9CZ04
 1800(L)×900(W)×760(H)mm
 2000(L)×900(W)×760(H)mm
 2200(L)×900(W)×760(H)mm
 2400(L)×900(W)×760(H)mm



9CZ05
 2139(L)×760(W)×760(H)mm
 2567(L)×915(W)×760(H)mm



9CZ10
 1830(L)×450(W)×760(H)mm
 1830(L)×600(W)×760(H)mm



9CZ11
 1830(L)×450(W)×760(H)mm
 1830(L)×600(W)×760(H)mm
 1830(L)×900(W)×760(H)mm



9CZ06
 φ1200×760(H)mm
 φ1500×760(H)mm
 φ1600×760(H)mm



9CZ07
 φ1200/910(L)×910(W)×760(H)mm
 φ1500/1150(L)×1150(W)×760(H)mm



9CZ12
 φ2400×760(H)mm
 φ2600×760(H)mm
 φ2800×760(H)mm



9CZ13
 φ3000×760(H)mm
 φ3200×760(H)mm
 φ3500×760(H)mm



9CZ14
 φ1200×760(H)mm
 φ1500×760(H)mm
 φ1800×760(H)mm



9CZ15
 φ1200×760(H)mm
 φ1500×760(H)mm
 φ1600×760(H)mm
 φ1800×760(H)mm



9CZ20
 1800(L)×450(W)×760(H)mm
 1800(L)×600(W)×760(H)mm
 1800(L)×760(W)×760(H)mm



9CZ20-1



9CZ16
 φ1200×760(H)mm
 φ1500×760(H)mm
 φ1600×760(H)mm
 φ1800×760(H)mm



9CZ17
 φ1200×760(H)mm
 φ1500×760(H)mm
 φ1600×760(H)mm
 φ1800×760(H)mm



9CZ21
 1800(L)×450(W)×760(H)mm
 1800(L)×600(W)×760(H)mm
 1800(L)×760(W)×760(H)mm



9CZ22
 2000(L)×600(W)×760(H)mm
 2400(L)×1200(W)×760(H)mm



9CZ18
 1800(L)×450(W)×760(H)mm
 1800(L)×600(W)×760(H)mm
 1800(L)×760(W)×760(H)mm



9CZ19
 1800(L)×450(W)×760(H)mm
 1800(L)×600(W)×760(H)mm
 1800(L)×760(W)×760(H)mm



9CZ23
 1800(L)×450(W)×760(H)mm
 1800(L)×600(W)×760(H)mm
 1800(L)×760(W)×760(H)mm



9CZ24
 1800(L)×450(W)×760(H)mm
 1800(L)×600(W)×760(H)mm
 1800(L)×760(W)×760(H)mm





9CZ25 1800(L)×450(W)×760(H)mm
1800(L)×600(W)×760(H)mm
1800(L)×760(W)×760(H)mm



9CZ26 1800(L)×450(W)×760(H)mm
1800(L)×600(W)×760(H)mm
1800(L)×760(W)×760(H)mm



9CZ31



9CZ32



9CZ33



9CZ27 1200(L)×450(W)×760(H)mm
1500(L)×450(W)×760(H)mm
1800(L)×450(W)×760(H)mm



9CZ28 1200(L)×450(W)×760(H)mm
1500(L)×450(W)×760(H)mm
1800(L)×450(W)×760(H)mm



9CZ34



9CZ35



9CZ36



9CZ29



9CZ30



9CZ37



9CZ38



9CZ39



9CZ40



9CZ41



9CZ42



9CZ49



9CZ50



9CZ51



9CZ52



9CZ43



9CZ44



9CZ45



9CZ53



9CZ54



9CZ55



9CZ56



9CZ46



9CZ47



9CZ48



9CZ57



9CZ58



9CZ59



9CZ60



9CZ61



9CZ62



9CZ63



9CZ64



9PT01 活动舞台
Mobile Stage

Size:
1220(W)×2440(L)mm
1830(W)×2440(L)mm
Height:
410/610mm
610/810mm



9PT02 舞池板舞台
Mobile Stage



9PT02 舞台裙

9PT03 舞台斜坡
Ramp

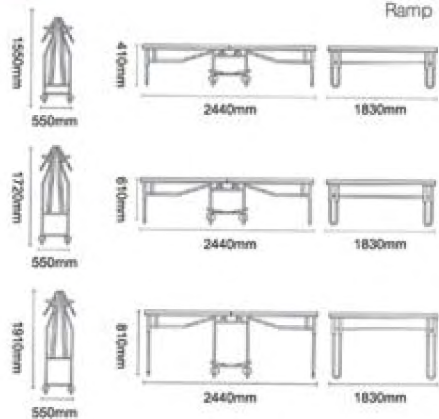

9PT04
980(W)×660(D)×500(H)mm



9PT05
980(W)×910(D)×720(H)mm



9PT06
1075(W)×1230(D)×1720(H)mm



9PT07
910(L)×910(W)mm



9PT07-1
900(L)×100(W)mm
1010(L)×100(W)mm

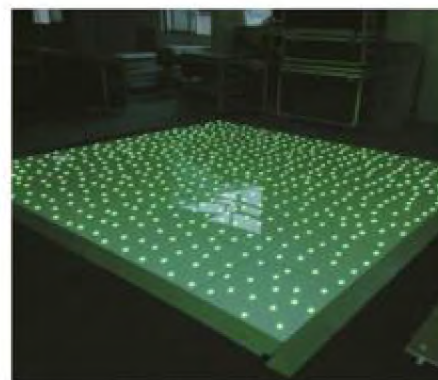

9PT08 500(L)×500(W)mm
600(L)×600(W)mm
600(L)×1200(W)mm



9PT09 910(L)×910(W)mm



9PT10



9PT11



9PT16

519(W)×426(D)×1005-1200(H)mm



9PT17

600(W)×513(D)×1100-1260(H)mm



9PT18

550(W)×495(D)×1195(H)mm



9PT12



9PT19

470(W)×470(D)×1100(H)mm



9PT20

470(W)×470(D)×1160(H)mm



9PT21

600(W)×505(D)×1190(H)mm



9PT13



9PT14



9PT15



9PT22

700(W)×450(D)×1200(H)mm



9PT23

800(W)×500(D)×1205(H)mm



9PT24

600(W)×450(D)×1130(H)mm



9PT25
620(L)×600(W)×1250(H)mm



9PT26
1130(L)×460(W)×1430(H)mm



9PT27
1880(L)×770(W)×980(H)mm



9PT34
945(L)×805(W)×1110(H)mm



9PT35
850(L)×450(W)×1100(H)mm



9PT36
770(L)×470(W)×800(H)mm



9PT28
1300(L)×730(W)×1050(H)mm



9PT29
1850(L)×900(W)×1130(H)mm



9PT30
1850(L)×900(W)×1200(H)mm



9PT37
1400(L)×550(W)×935(H)mm



9PT38
φ400(L)×740(H)mm



9PT39
φ1090×910(W)×750(H)mm



9PT31
1870(L)×920(W)×1130(H)mm



9PT32
1050(L)×610(W)×900(H)mm



9PT33
1050(L)×610(W)×1860(H)mm



9PT40
1400(L)×480(W)×1100(H)mm



9PT41
1100(L)×650(W)×950(H)mm



9PT42
1350(L)×750(W)×1730(H)mm



9PT43 700(L)×500(W)×1440(H)mm
9PT44 654(L)×600(W)×1600(H)mm
9PT45 545(L)×350(W)×1420(H)mm
9PT46 810(L)×600(W)×1217(H)mm



9PT47 890(L)×750(W)×1340(H)mm
9PT48 850(L)×600(W)×1540(H)mm
9PT49 800(L)×700(W)×1300(H)mm
9PT50 1050(L)×700(W)×1450(H)mm



9PT51 φ95×380(H)mm φ95×150(H)mm
9PT52 550(L)×250(W)×1200(H)mm
9PT53 430(L)×340(W)×1390(H)mm
9PT54 280(L)×230(W)×595(H)mm



9PT55 600(L)×465(W)×530(H)mm
9PT56 410(L)×520(W)×580(H)mm
9PT57 660(L)×500(W)×500(H)mm
9PT58 660(L)×500(W)×500(H)mm



9PT59 700(L)×550(W)×700(H)mm
9PT60 600(L)×470(W)×660(H)mm
9PT61 600(L)×445(W)×670(H)mm
9PT62 460(L)×505(W)×800(H)mm



9PT63

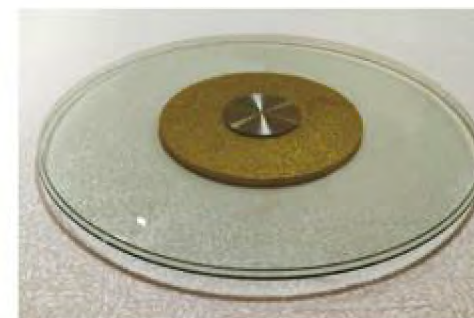

9PT64

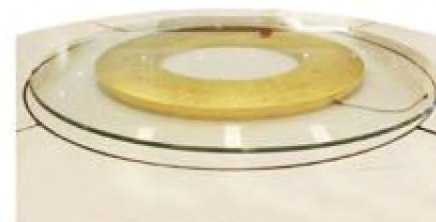

9PT65



9PT66



9PT67
φ1200×760(H)mm



9PT68
φ330×1000(H)mm



9PT69
φ330×910(H)mm



9PT70
φ320×910(H)mm



9PT71
1500(L)mm



9PT72
1500(L)mm



9PT73
490(L)×290(W)×780(H)mm



9PT74
580(L)×500(W)×900(H)mm



9PT75
635(L)×380(W)×920(H)mm



9PT76



9PT77



9PT78



9PT79



9PT80



9PT81



9PT82



9PT83

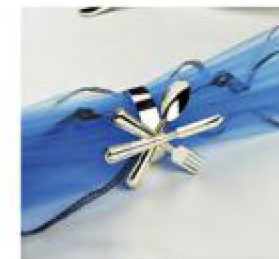

9PT84



9PT85



9PT86



9PT87



9PT88



9PT89



9PT90



9PT91



9PT92



9PT93



9PT94



9PT95



9PT96



9PT97



9PT98



9PT99



9PT100



9PT101



9PT102



9PT103



9PT104



9PT105



9PT106



9PT107



9PT108



9PT109



9PT110



9PT111



9PT112



9PT113



9PT114



9PT115



9PT116



9PT117



9PT118



9PT119
310(L)×300(W)×700(H)mm



9PT120
φ300×650(H)mm



9PT121
300(L)×300(W)×770(H)mm



9PT122
300(L)×300(W)×630(H)mm



9PT123
φ320×680(H)mm



9PT124
310(L)×260(W)×685(H)mm



9PT125
280(L)×220(W)×770(H)mm



9PT126
240(L)×240(W)×620(H)mm