



Steel Structure Expert  
专业钢结构制造商

**GROW UP**  
**YOUR BUSINESS WITH US**



**ONE CHOICE , LONG LIFE TRUST**

一次选择, 终身信任



## **CONTENTS** 目录

- 01 ▶ About us**  
关于我们 01
- 02 ▶ Our service**  
我们的服务 05
- 03 ▶ Main products**  
主营产品 06
- 04 ▶ Projects**  
工程案例 27
- 05 ▶ Partners**  
合作伙伴 37



# COMPANY SHOW

## 公司展示

### Steel structure production lines 钢结构生产线



### Color steel/sandwich panel 彩钢单板/夹芯板生产线



### C/Z type steel production lines C/Z型钢生产线





# OUR SERVICES

我们的服务



## DESIGN 设计

We have an efficient, professional and high-quality team of designers. Team members have at least 15 years of experience in steel structure project design in this industry.

我们拥有一支高效，专业，高素质的设计师队伍。团队成员在该行业中至少有15年的钢结构项目设计经验。

## MANUFACTURING 生产

We have 23 production lines of various types of steel structures and plates, covering the production and processing of all materials in the steel structure construction industry.

我们拥有23条各种类型的钢结构和板材生产线，涵盖了钢结构建筑行业中所有材料的生产加工。



## CONSTRUCTION 建造

We specialize in steel structures and have experienced field personnel who can install projects on a global scale. At the same time, we can also provide technical support for the installation.

我们专业做钢结构，拥有经验丰富的现场人员，可以在全球范围内安装项目。同时，我们也可以为安装提供技术支持。



YOUR BUILDING BEST SOLUTION

# MAIN PRODUCTS

主营产品



STEEL STRUCTURE  
钢结构



WAREHOUSE/WORKSHOP  
仓库/厂房



CONTAINER HOUSE  
集装箱房



PREFAB  
轻钢别墅



COLOR STEEL SHEETS  
彩钢板

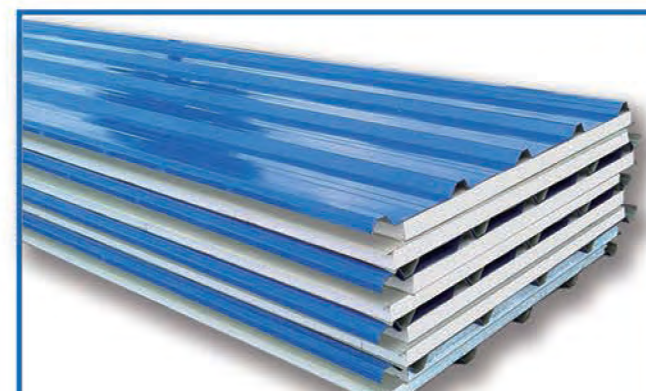

SANDWICH PANELS  
夹芯板



### STEEL STRUCTURE INTRODUCTION

#### 钢结构介绍



Steel structure is a metal structure which is made of structural steel components connect with each other to carry loads and provide full rigidity. Because of the high strength grade of steel, this structure is reliable and requires less raw materials than other types of structure like concrete structure and timber structure. The entire primary members and secondary members are designed and fully fabricated in the factory before shipped to the site for erection. All components are assembled and jointed via nut & bolt connections to cut cost and time.

In modern construction, steel structures is used for almost every type of structure including heavy industrial building, high-rise building, equipment support system, infrastructure, bridge, tower, airport terminal, heavy industrial plant, pipe rack, etc.

钢结构是一种金属结构，由结构钢部件相互连接以承载载荷并提供充分的刚性。由于钢的强度高，这种结构可靠，与其他类型的结构（如混凝土结构和木材结构）相比，所需的原材料更少。所有主要构件和次要构件都是在工厂设计和完全制造的，然后运到现场安装。所有部件通过螺母和螺栓连接进行组装和连接；从而降低了成本和装配时间。

在现代建筑中，钢结构几乎用于所有类型的结构，包括重型工业建筑，高层建筑，设备支撑系统，基础设施，桥梁，塔楼，机场航站楼，重型工业厂房，管架等。

### STEEL STRUCTURE APPLICATION

#### 钢结构应用



Commercial Building  
商业建筑



Infrastructure Building  
公共建筑



Warehouse/Workshop  
仓库/厂房



Farm House  
农场建筑



Hangar  
飞机库



Bridge  
桥梁



Clean/Cold Room  
净化室/冷库



Sports Hall  
运动馆



# PREFAB HOUSE

预制房屋

## PREFAB HOUSE INTRODUCTION

活动房屋介绍



Prefabricated construction is the practice of assembling a variety of components of a structure at a manufacturing site and transporting those sub-assemblies to the location of the construction job-site.

The new type of prefabricated building uses cold-pressed light steel structure and various parts of light-weight material combination house. This kind of building is fast to build, less restricted by the environment, saves labor, and has high quality. It has good thermal insulation, sound insulation, fire prevention, insect prevention, energy saving, earthquake resistance, and moisture resistance. Prefabricated construction is becoming more common, improving in quality and has become available in a variety of budgets.

装配式建筑指预制构件在工地上装配而成的建筑。

新型的装配式建筑采用冷压轻钢结构以及各类轻型材料组合房屋的各个部分，有很好的保温、隔音、防火、防虫、节能、抗震、防潮功能。预制建筑变得越来越普遍，质量得到提高，并且可以在各种预算区间中使用。

## PREFAB HOUSE SHOW

活动房屋展示





# SANDWICH PANEL

夹芯板

## PU SANDWICH PANEL

聚氨酯夹芯板



Polyurethane sandwich panel is a bimetallic, single-metal, non-metal composite sheet made of polyurethane rigid foam as insulation layer. It is usually used in industrial plants, logistics storage, wall and roof enclosure systems for integrated houses.

The polyurethane sandwich panel produced by [ ] Group has many advantages, such as energy saving, heat preservation, flame retardancy, fire prevention, sound insulation, noise reduction, environmental protection, beauty, economy and quick construction. Our company uses raw materials are Huntsman, Shanghai Baosteel, Shandong crown state and other top suppliers of materials. The company has the international leading technical team and R & D team, using the international advanced production line to produce polyurethane wall panel, roof panel, polyurethane polyurethane clean board, polyurethane cold plate, polyurethane side seal rock wool fireproof board, polyurethane glass panels and other side sealing plate.

## APPLICATIONS 应用

Sandwich panels is widely used steel structure warehouse/workshop, fire prevention workshop, activity board room, chicken house, in cold storage room, fresh storage room, various purification rooms, air conditioning room, etc.

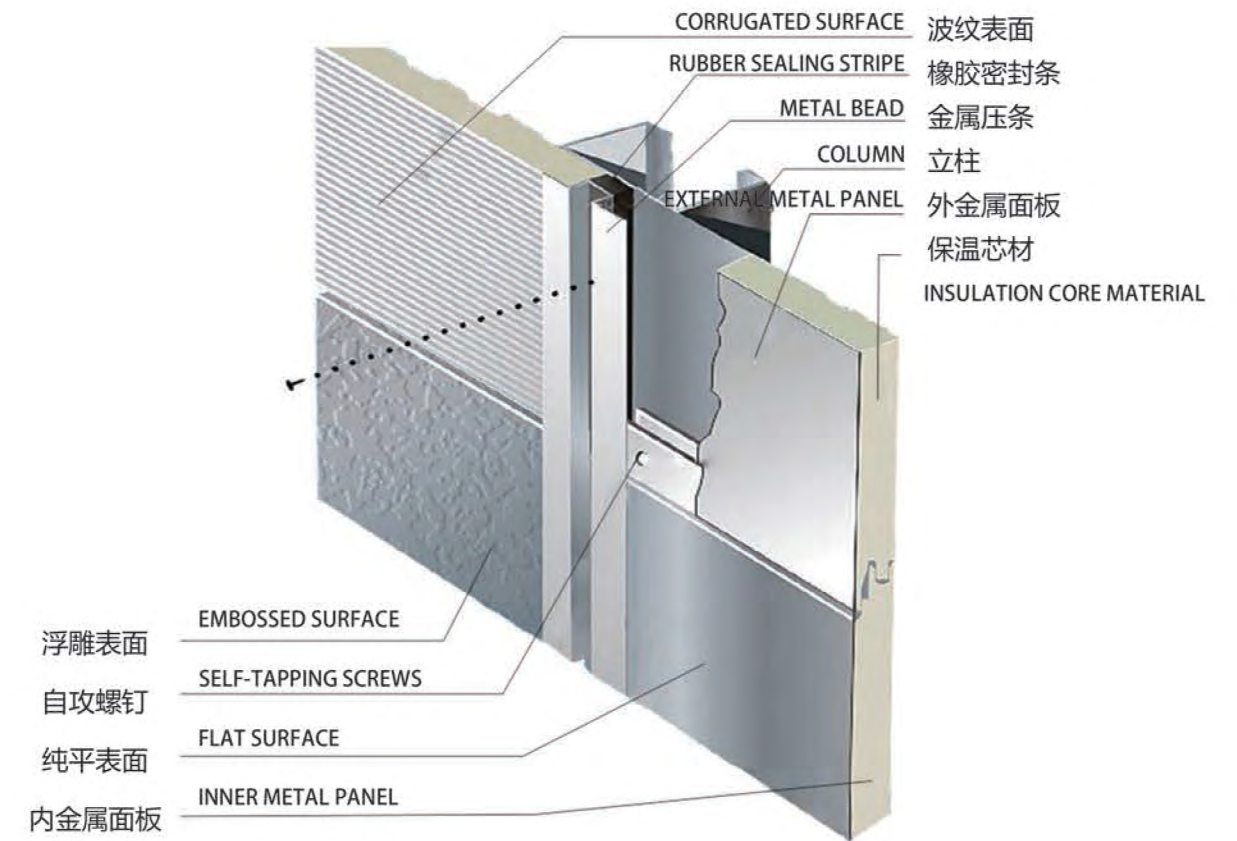

标准名称	STANDARD	PUR	PIR
芯材密度	Core Density	40-45	45-50
闭孔率	Closed cell rate	≥97%	≥97%
导热系数	Thermal Conductivity	≤0.023	≤0.023
耐高低温范围	Heat-resistant range	-55℃-120℃	-50℃-160℃
燃烧性能	Combustion performance	≥D	≥B



# SANDWICH PANEL

## 夹芯板

### ROCK WOOL /GLASS WOOL PANELS

#### 岩棉/玻璃棉板

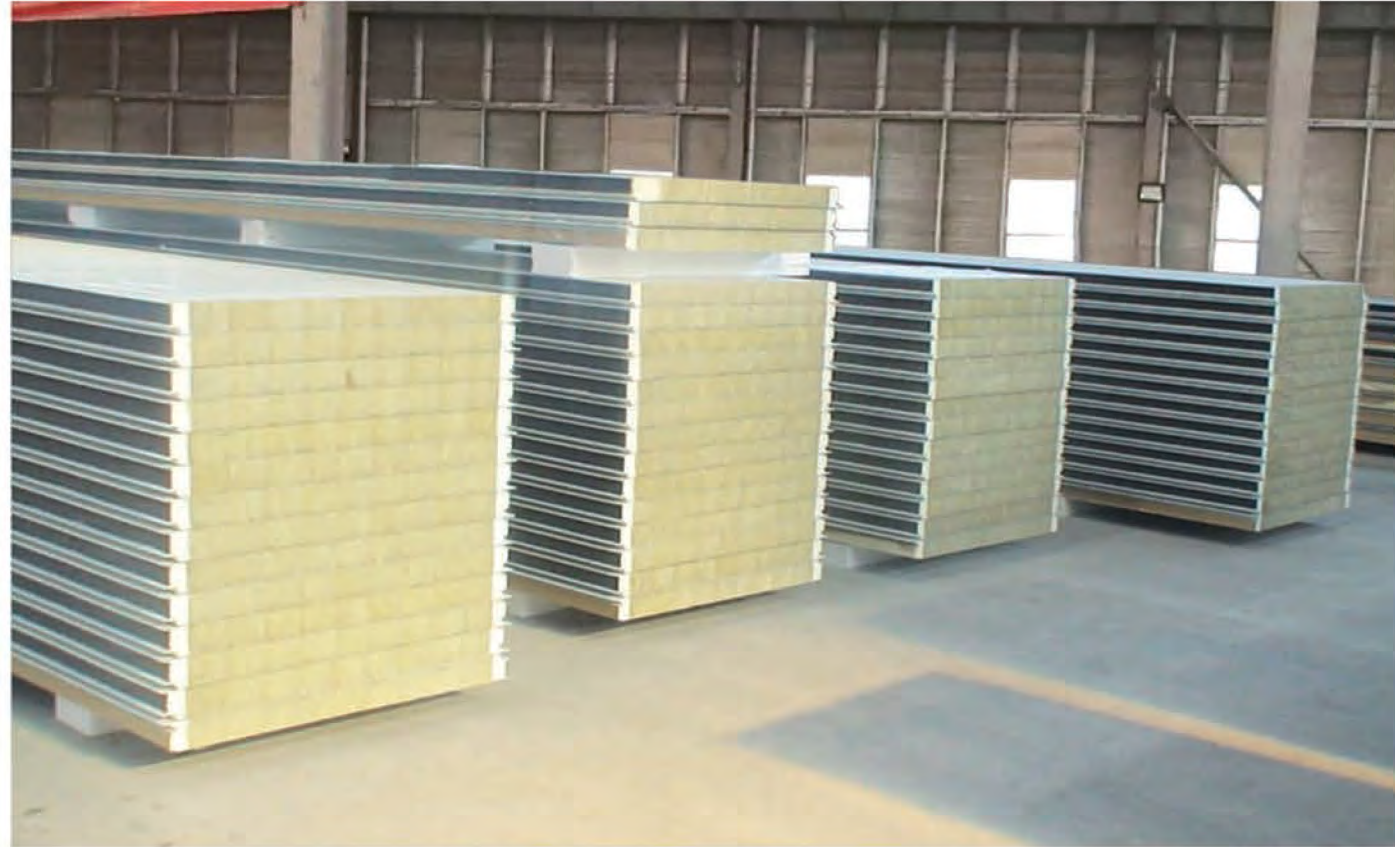

Rock wool sandwich panels have significant effects on fire prevention, thermal insulation, sound absorption and sound insulation.

岩棉夹芯板在防火，保温隔热，吸音隔声等方面有着显著的功效。

### BASIC PARAMETERS 基本参数

标准名称	STANDARD	岩棉 ROCKWOOL	玻璃丝棉 GLASSWOOL
芯材密度	Core Density	80-120kg/m <sup>3</sup>	64kg/m <sup>3</sup>
涂层和镀层	Coating and Plating	PE, HDP, PVDF, SMF / Hot-galvanize, Aluminium Coating	
导热系数	Thermal Conductivity	≤0.046w/m	≤0.042w/(m.k)
隔音系数	Sound Insulation	≥30db	≥30db
阻燃等级	Flammability Rating	A	A

#### Rock wool panel with PU siding

聚氨酯包边岩棉板

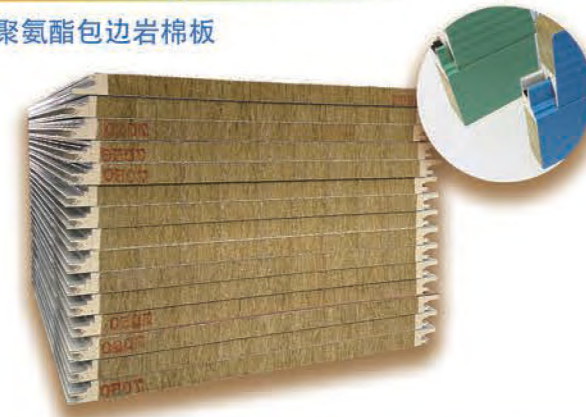

Effective coverage width 有效宽度	1000mm
Profile types 面板效果	Upper plate high wave crest 上波峰 Under the flat plate 下平板
Sheet thickness 彩钢板厚度	Sheet : 0.2mm to 0.8mm
Sheet color 彩钢板颜色	Customer customize 客户自定义
Thickness 芯材厚度	50/75//100/150/200mm

#### Rock wool wall sandwich panel

岩棉夹芯墙板

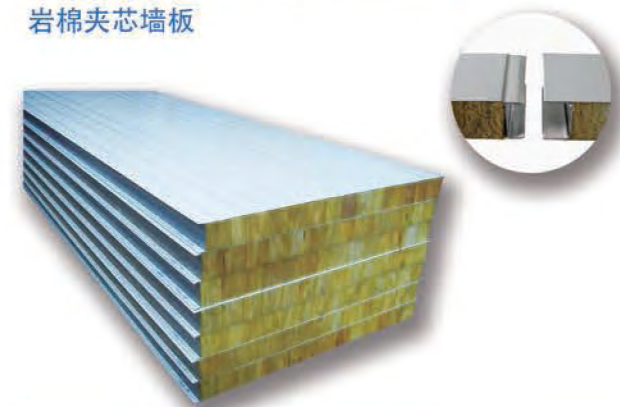

Effective coverage width 有效宽度	950mm/1150mm
Profile types 面板效果	Upper plate high wave crest 上波峰 Under the flat plate 下平板
Sheet thickness 彩钢板厚度	Sheet : 0.2mm to 0.8mm
Sheet color 彩钢板颜色	Customer customize 客户自定义
Thickness 芯材厚度	50/75//100/150/200mm

#### Acoustic Rock wool sandwich panel

岩棉吸音板

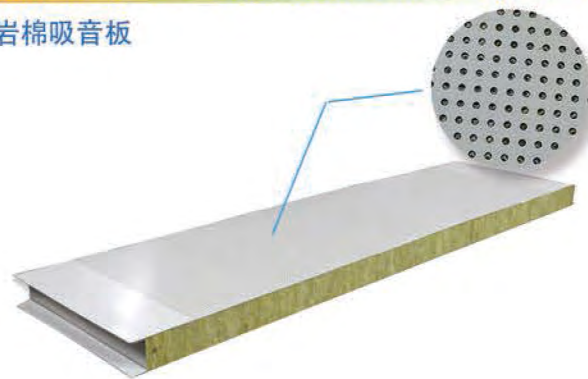

Effective coverage width 有效宽度	950mm/1150mm
Profile types 面板效果	Upper plate high wave crest 上波峰 Under the flat plate 下平板
Sheet thickness 彩钢板厚度	Sheet : 0.2mm to 0.8mm
Sheet color 彩钢板颜色	Customer customize 客户自定义
Thickness 芯材厚度	50/75//100/150/200mm

#### Rock wool oven panel

岩棉烘道板

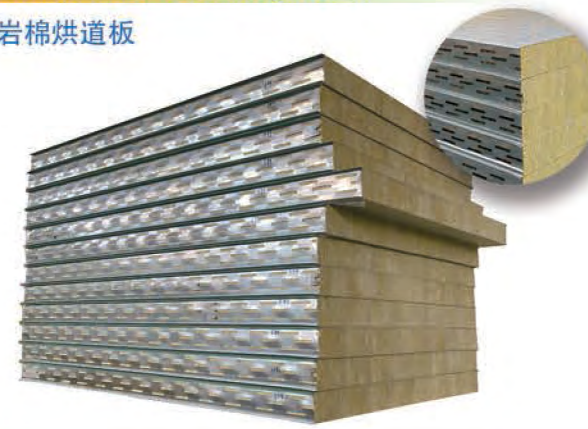

Effective coverage width 有效宽度	950mm/1150mm
Profile types 面板效果	Upper plate high wave crest 上波峰 Under the flat plate 下平板
Sheet thickness 彩钢板厚度	Sheet : 0.2mm to 0.8mm
Sheet color 彩钢板颜色	Customer customize 客户自定义
Thickness 芯材厚度	50/75//100/150/200mm



### PU PUR PIR wall panel

聚氨酯墙板

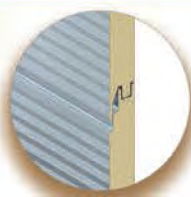
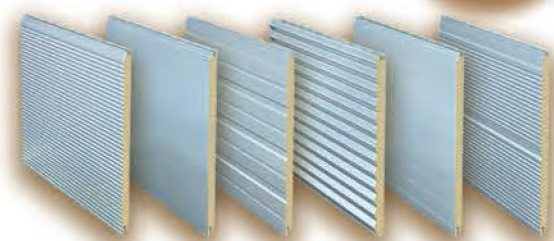

Effective coverage width 有效宽度	1000mm/1m
Profile types 面板效果	Microprofiling/Lined/Plain 小波纹/方波纹/扁平
Color steel plate thickness 彩钢板厚度	0.4mm to 0.8mm
Color of color steel plate 彩钢板颜色	Customer customize/Aluminum plate 客户自定义/铝板
Polyurethane core thickness 聚氨酯芯厚度	50mm/75mm/80mm 100mm/150mm/200mm

### PU PUR PIR roof panel

聚氨酯顶板

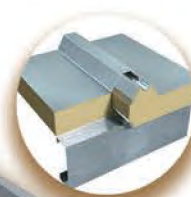
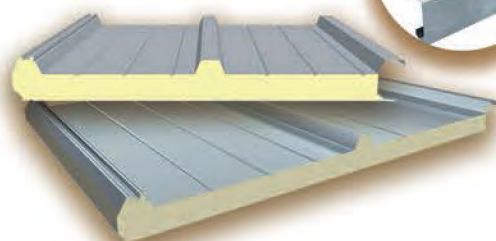

Effective coverage width 有效宽度	1000mm/1m
Profile types 面板效果	3/4 Ribs 外板高波峰
Color steel plate thickness 彩钢板厚度	0.4mm to 0.8mm
Color of color steel plate 彩钢板颜色	Customer customize/Aluminum plate 客户自定义/铝板
Polyurethane core thickness 聚氨酯芯厚度	50mm/75mm/80mm/100mm/150mm

### Polyurethane cold storage panel

聚氨酯冷库板

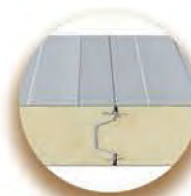

Effective coverage width 有效宽度	1000mm/1120mm
Profile types 面板效果	Lined 方波
Color steel plate thickness 彩钢板厚度	0.4mm to 0.8mm
Color of color steel plate 彩钢板颜色	Customer customize/Aluminum plate 客户自定义/铝板
Polyurethane core thickness 聚氨酯芯厚度	50/75/80/100/120/150/200mm

### Camlock cold room panel

挂钩冷库板



Effective coverage width 有效宽度	960mm/1150mm
Profile types 面板效果	Microprofiling/Plain 小波纹/纯平
Color steel plate thickness 彩钢板厚度	0.4mm to 0.8mm
Color of color steel plate 彩钢板颜色	Customer customize/Aluminum plate 客户自定义/铝板
Polyurethane core thickness 聚氨酯芯厚度	50/75/80/100/150/200mm

### EPS Roof sandwich panel

聚苯乙烯泡沫顶板



Effective coverage width 有效宽度	950mm
Profile types 面板效果	Upper 5 Ribs上波峰 Under Plain 下平板
Sheet thickness 彩钢板厚度	Sheet : 0.2mm to 0.8mm
Sheet color 彩钢板颜色	Customer customize 客户自定义
Thickness 芯材厚度	50/75//100/150/200mm

### EPS Wall sandwich panel

聚苯乙烯泡沫墙板



Male/Female

Effective coverage width 有效宽度	950mm/1150mm
Profile types 面板效果	Upper plate high wave crest 上波峰 Under the flat plate 下平板
Sheet thickness 彩钢板厚度	Sheet : 0.2mm to 0.8mm
Sheet color 彩钢板颜色	Customer customize 客户自定义
Thickness 芯材厚度	50/75//100/150/200mm

### EPS Wall sandwich panel

聚苯乙烯泡沫墙板

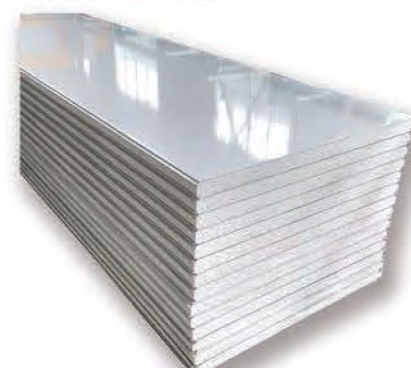

Z-lock

Effective coverage width 有效宽度	950mm/1150mm
Profile types 面板效果	Upper plate high wave crest 上波峰 Under the flat plate 下平板
Sheet thickness 彩钢板厚度	Sheet : 0.35mm to 0.8mm
Sheet color 彩钢板颜色	Customer customize 客户自定义
Thickness 芯材厚度	50/75//100/150/200mm

### Rock wool roof sandwich panel

岩棉夹芯顶板

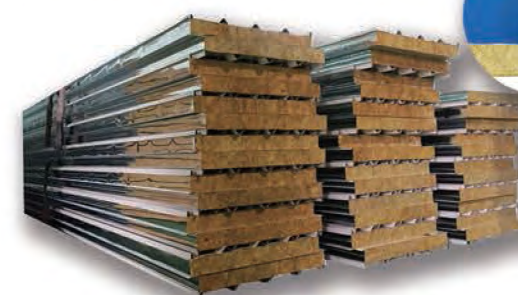

Effective coverage width 有效宽度	950mm
Profile types 面板效果	Upper 5 Ribs上波峰 Under Plain 下平板
Sheet thickness 彩钢板厚度	Sheet : 0.2mm to 0.8mm
Sheet color 彩钢板颜色	Customer customize 客户自定义
Thickness 芯材厚度	50/75//100/150/200mm



# CORRUGATED SHEET

瓦楞板

## COLOR STEEL PLATE/STEEL FLOOR

彩钢板/楼承板



Color steel plate has many advantages such as colorful, rich varieties, complete type plate .

The thickness of the color plate substrate adopted by our company must conform to the national standard thickness, all steel plates are hot-dip galvanized steel plate, the thickness of galvanized is high.

The color steel plate adopted by our company introduces international famous brand which is anti-fade, anti-aging, high temperature resistant special paint, guarantee product quality, the useful life is more 10 years than ordinary color steel plate

彩钢板具有色彩丰富，品种丰富，板型齐全等优点。

我公司采用的彩钢板基材的厚度必须符合国家标准厚度，所有钢板均为热浸镀锌钢板，镀锌厚度较高。

我公司采用的彩钢板引进了国际著名品牌的抗褪色，抗老化，耐高温特种涂料，保证了产品质量，使用寿命比普通彩钢板长10年以上。

### CL-W840 Type Roof sheet

CL-W840 屋顶波形板

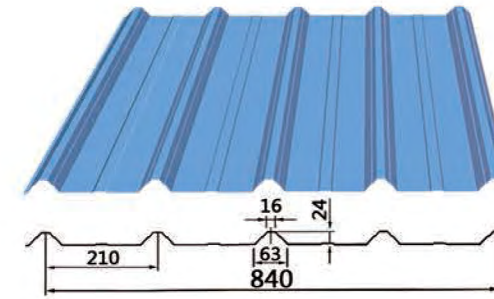

Coverage width 覆盖宽度	840mm	
Sheet thickness 钢板厚度	0.3mm to 0.8mm	
Section inertia(cm <sup>4</sup> /m) 截面惯性	28.00	49.01
Section resistance(cm <sup>3</sup> /m) 截面阻力	15.22	26.49
Purpose 用途	Roofing sheet 屋顶波形板	

### CL-W820 Type Roof sheet

CL-W820 屋顶波形板

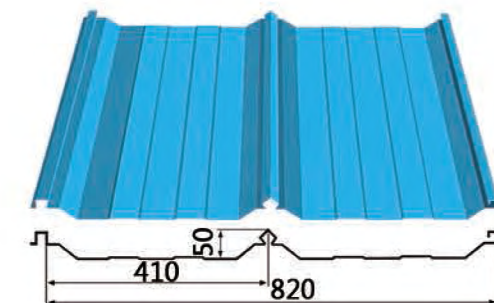

Coverage width 覆盖宽度	820mm	
Sheet thickness 钢板厚度	0.3mm to 0.8mm	
Section inertia(cm <sup>4</sup> /m) 截面惯性	28.00	49.01
Section resistance(cm <sup>3</sup> /m) 截面阻力	15.22	26.49
Purpose 用途	Roofing sheet 屋顶波形板	

### CL-W750 Type Wall sheet

CL-W750 屋顶波形板

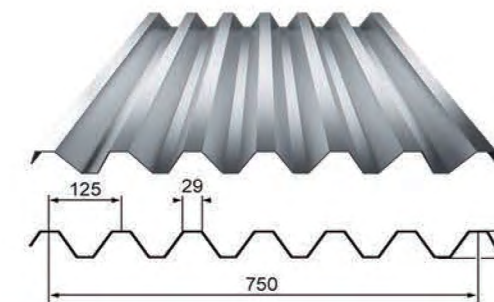

Coverage width 覆盖宽度	750mm	
Sheet thickness 钢板厚度	0.8mm to 1.2mm	
Section inertia(cm <sup>4</sup> /m) 截面惯性	33.91	50.87
Section resistance(cm <sup>3</sup> /m) 截面阻力	12.07	18.91
Purpose 用途	Wall sheet 墙板	

### CL-W900 Type wall sheet

CL-W900 墙板

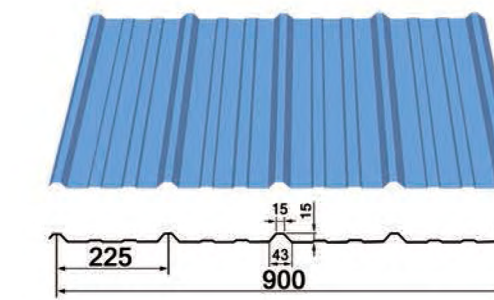

Coverage width 覆盖宽度	900mm	
Sheet thickness 钢板厚度	0.3mm to 0.8mm	
Section inertia(cm <sup>4</sup> /m) 截面惯性	1.39	1.85
Section resistance(cm <sup>3</sup> /m) 截面阻力	1.13	1.49
Purpose 用途	Wall sheet 墙板	



## CL-W850 Type wall sheet

CL-W850 墙板



Coverage width 覆盖宽度	850mm	
Sheet thickness 钢板厚度	0.3mm to 0.8mm	
Section inertia(cm <sup>4</sup> /m) 截面惯性	28.56	38.08
Section resistance(cm <sup>3</sup> /m) 截面阻力	3.42	6.83
Purpose 用途	Roofing/wall sheet 屋顶波形板/墙板	

## CL-W750 Type wall sheet

CL-W750 墙板

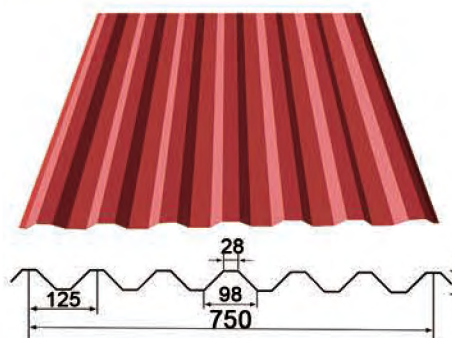

Coverage width 覆盖宽度	750mm	
Sheet thickness 钢板厚度	0.3mm to 0.8mm	
Section inertia(cm <sup>4</sup> /m) 截面惯性	6.92	12.12
Section resistance(cm <sup>3</sup> /m) 截面阻力	3.70	6.13
Purpose 用途	Wall sheet 墙板	

## CL-W688 Type Decking board

CL-W688 楼承板

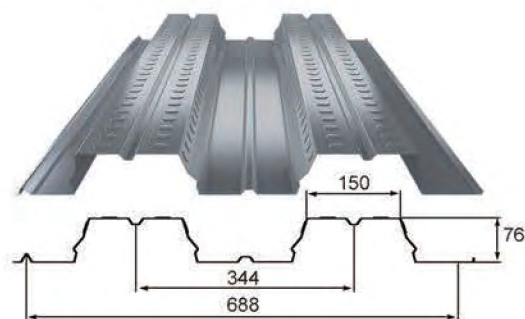

Coverage width 覆盖宽度	688mm	
Sheet thickness 钢板厚度	0.8mm to 1.6mm	
Section inertia(cm <sup>4</sup> /m) 截面惯性	84.14	126.23
Section resistance(cm <sup>3</sup> /m) 截面阻力	20.23	30.20
Purpose 用途	Galvanized steel floor 镀锌楼承板	

## CL-W915 Type Decking board

CL-W915 楼承板

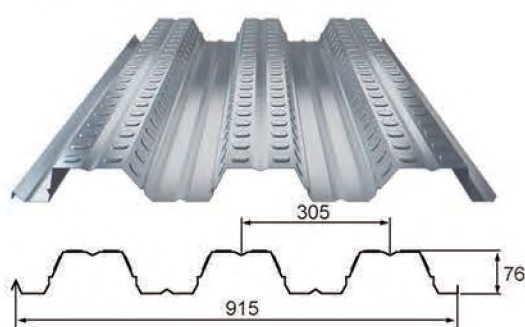

Coverage width 覆盖宽度	915mm	
Sheet thickness 钢板厚度	0.8mm to 1.6mm	
Section inertia(cm <sup>4</sup> /m) 截面惯性	98.41	147.64
Section resistance(cm <sup>3</sup> /m) 截面阻力	24.6	36.73
Purpose 用途	Galvanized steel floor 镀锌楼承板	

## C/Z TYPE STEEL PROFILE

C / Z型钢型材



The size of C-section steel (purlin)							
TYPE	H	B1	B2	C	Thickness(mm)	Hole distance	
C80	80	30	30	20	1.5-2.0		
C100	100	50	50	20	1.5-2.0		
C120	120	50	50	20	1.5-2.0		
C140	140	50	50	20	2.0-2.5	Self	
C160	160	50	50	20	2.0-3.0	adjustable	
C180	180	60	60	20	2.0-3.0		
C200	200	60	60	20	2.0-3.0		
C220	220	70	70	20	2.0-3.0		
C250	250	70	70	20	2.0-3.0		
C300	300	80	80	20	2.0-3.0		

The size of Z-section steel (purlin)							
TYPE	H	B1	B2	C	Thickness(mm)	Hole distance	
Z100	100	50	50	20	1.5-2.0		
Z120	120	50	50	20	1.5-2.0		
Z140	140	50	50	20	1.5-2.0		
Z160	160	50	50	20	2.0-2.5	Self	
Z180	180	60	60	20	2.0-3.0	adjustable	
Z200	200	60	60	20	2.0-3.0		
Z220	220	70	70	20	2.0-3.0		
Z250	250	70	70	20	2.0-3.0		
Z280	280	80	80	20	2.0-3.0		
Z300	300	80	80	20	2.0-3.0		



# MATCHING PRODUCTS

## 配套产品

In addition to steel structure building related products, we also supply cranes, doors and windows and other supporting products to save you time and money.

除了钢结构建筑相关产品外，我们还提供起重机、门窗等配套产品，为您节省时间和金钱。

## CRANE

### 吊车



Double Beam Crane  
双梁起重机



Single Beam Crane  
单梁起重机

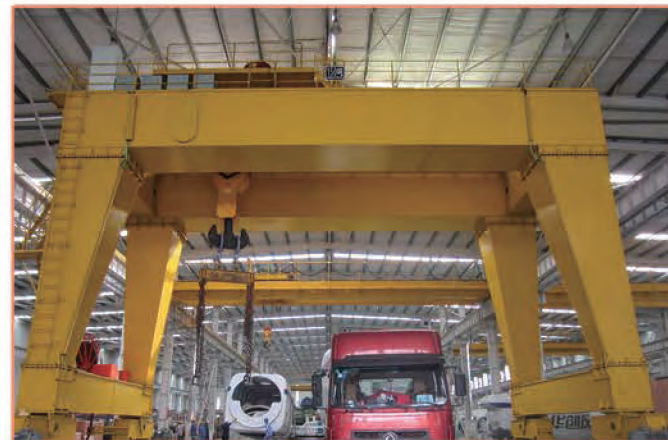

Gantry Crane  
门式起重机



Cantilever  
悬臂机

## DOOR/WINDOW

### 门/窗



Cold Room Door  
冷库门



Clean Room Door  
净化门



Automatic Lifting Door  
自动提升门



Sliding Door  
推拉门



Rolling Shutter Door  
卷帘门



Sandwich Panel Door  
复合板门



Transfer Window  
传递窗



Window Shutter  
百叶窗



Aluminum Alloy Window  
铝合金窗



Plastic Steel Window  
塑钢窗



# AUXILIARY PRODUCT

## 附件产品



self-tapping screw  
自攻钉



rivet  
拉铆钉



waterproof cap  
防水帽



polyurethane glass glue  
聚氨酯玻璃胶



wrap angle accessory  
包口包角附件



ridge tile  
外脊瓦



waterproof eaves  
防水檐

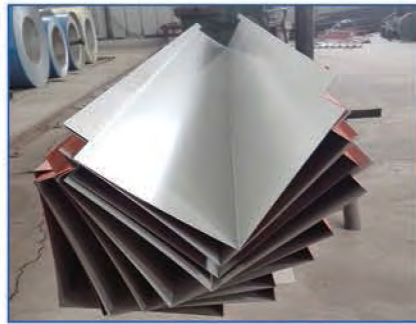

outside corner  
阳角

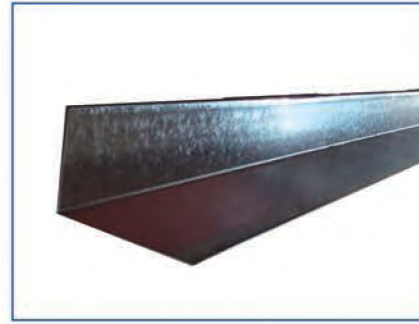

inside corner  
阴角

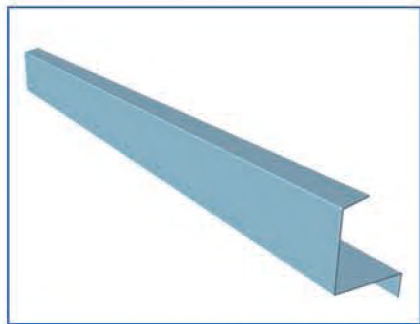

eaves edge  
檐包边



plug  
堵头



door and window edge  
门窗包边

# ALUMINUM PROFILE

## 净化铝型材



75转50夹芯板门料  
Door material



中字铝  
中-shaped aluminum



中字铝吊梁  
中-shaped aluminum hanging beam



双面压线中柱  
Double-sided crimping column

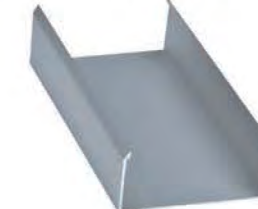

50槽铝  
50 aluminium groove



50固定窗  
50 fixed window



38角铝  
38 angle aluminum



25角铝  
25 angle aluminum



50门包边  
50 door edge



50门边框  
50 door frame



50夹芯板门料 II  
50 door material II



50夹芯板门料 I  
50 door material I



50内圆弧  
50 Inner arc

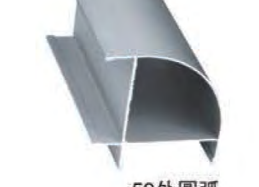

50外圆弧  
50 outer arc



50内圆弧底座  
50 Inner arc base

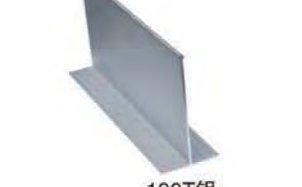

100T铝  
100T aluminium



单面压线中柱  
Single-sided crimping center column

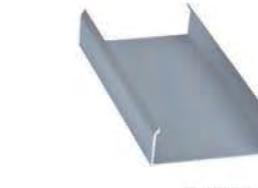

75槽铝  
75 aluminium groove



100槽铝  
100 aluminium groove



固定窗斜压线  
Barocline of fixed window



50工字铝  
50 H-shaped aluminium



固定窗弧形压线  
Curved crimp of fixed window



# PROJECT CASE

## 工程案例



Group steel construction started early, mature technology, obtained the affirmation and recognition of the market in the multi storied steel structure construction field, in recent years the group in the original technical service can be improved, and the global customers more convenient, achieve 100% component factory manufacture, field installation more simple (integrated assembly residential system) allows you to, like building blocks to build houses and buildings, longer service life, using more complete function!

Since we established 17 years, through continuous improvement of the quality system and management system, we have respectively passed the ISO9001:2008 Quality Management System certification and CE-EN1090 certification. Our products are exported to more than 120 countries in the world, and obtained the general customer approval.

ONE CHOICE, LONG TRUST!



### USA Large Commercial Warehouse

Building area: 3200 square meters  
 Amount of steel structure: 105 tons  
 Building type: Steel structure warehouse  
 Contract: We provide calculation, design drawings, deepening drawings, processing and manufacturing, transportation (steel structure, composite panels, doors and windows, bolts, gutter downpipes, etc.)  
 Date of signing: November 20, 2020  
 Shipping deadline: March 1, 2021 to April 15, 2021  
 Shipment Batch: 3 times  
 Completion date: July 24, 2021

### 美国大型商业仓库

建筑面积: 3200平方米  
 钢结构用量: 105吨  
 建筑类型: 钢结构仓库  
 合同: 我方提供计算, 设计图纸, 深化图纸, 加工制造, 运输 (钢构, 复合板, 门窗, 螺栓, 天沟落水管等)  
 签署日期: 2020年11月20日  
 运输截止日期: 2021年3月1日至2021年4月15日  
 发货批次: 3次  
 完成日期: 2021年7月24日



### Thailand Lime Processing Factory

Building area: 2160 square meters  
 Amount of steel structure: 88 tons  
 Building type: steel structure workshop  
 Construction type: materials and on-site guidance for installation (steel structure, color steel plates, doors and windows, high-strength bolts, cranes, water supply and drainage pipes, and other materials and guidance for installation)  
 Date: September 16, 2019  
 Shipping deadline: November 25, 2019 to February 2, 2020  
 Shipment Batch: 1 time  
 Completion date: June 13, 2020

### 泰国石灰加工厂

建筑面积: 2160平方米  
 钢结构用量: 88吨  
 建筑类型: 钢结构车间  
 建筑类型: 材料和现场指导安装 (钢结构, 彩色钢板, 门窗, 高强度螺栓, 起重机, 给排水管等材料和指导安装)  
 签署日期: 2019年9月16日  
 运输截止日期: 2019年11月25日至2020年2月2日  
 发货批次: 1次  
 完成日期: 2020年6月13日





**Australian Furniture Factory**

Building area: 6405 square meters  
 Amount of steel structure: 377 tons  
 Construction type: Steel structure furniture factory  
 Contract: we provide calculations, deepen drawings, processing and manufacturing, transportation  
 Date of signing: September 18, 2018  
 Shipping deadline: December 15, 2018 to January 10, 2019  
 Shipment batch: 2 times  
 Completion Date: May 20, 2019

澳大利亚家具厂  
 建筑面积: 6405平方米  
 钢结构用量: 377吨  
 建筑类型: 钢结构家具厂  
 合同: 我方提供计算, 深化图纸, 加工制造, 运输  
 签署日期: 2018年9月18日  
 运输截止日期: 2018年12月15日至2019年1月10日  
 发货批次: 2次  
 完成日期: 2019年5月20日



**Canda Steel Cow Farm**

Building area: 2100 square meters  
 Steel structure consumption: 110 tons  
 Building type: Steel structure cow shed  
 Contract: Materials and guidance installation (steel structure, composite panels, cattle breeding equipment, high-grade doors and windows, sunshine tiles, high-strength bolts, drainage pipes, accessories and other materials)  
 Signing date: August 1, 2018  
 Deadline for transportation: August 20, 2018 to November 6, 2018  
 Delivery batch: 2 times  
 Completion Date: December 24, 2018

加拿大钢结构养牛场  
 建筑面积: 2100平方米  
 钢结构用量: 110吨  
 建筑类型: 钢结构牛棚  
 合同: 材料和指导安装 (钢结构, 复合板, 养牛设备, 高档门窗, 阳光瓦, 高强度螺栓, 排水管, 附件等材料)  
 签署日期: 2018年8月1日  
 运输截止日期: 2018年8月20日至2018年11月6日  
 发货批次: 2次  
 完成日期: 2018年12月24日



**Philippine Food Processing Factory**

Building area: 5508 square meters  
 Amount of steel structure: 112 tons  
 Construction type: Steel structure food factory  
 Contract: We provide review of customer design drawings, calculation of materials, deepening of drawings, processing and manufacturing, transportation (steel structure, composite panels, doors and windows, bolts, gutter downpipes, etc.)  
 Date of signing: August 28, 2019  
 Shipping deadline: November 15, 2019 to January 10, 2020  
 Shipment Batch: 1 time

菲律宾食品加工厂  
 建筑面积: 5508平方米  
 钢结构用量: 112吨  
 建筑类型: 钢结构食品厂  
 合同: 我方提供审核客户设计图纸, 计算材料, 深化图纸, 加工制造, 运输 (钢结构, 复合板, 门窗, 螺栓, 天沟落水管等)  
 签署日期: 2019年8月28日  
 运输截止日期: 2019年11月15日至2020年1月10日  
 发货批次: 1次



**Costa Rica beverage factory production workshop**

Building area: 560 square meters  
 Steel structure consumption: 30 tons  
 Building type: Steel structure workshop  
 Building type: materials and on-site installation guide (steel structure, colored steel plates, doors and windows, high-strength bolts, water supply and drainage pipes and other materials and installation guide)  
 Signing Date: May 1, 2019  
 Deadline for transportation: May 25, 2019 to August 2, 2019  
 Delivery batch: 2 times  
 Completion Date: October 13, 2019

哥斯达黎加饮料厂生产车间  
 建筑面积: 560平方米  
 钢结构用量: 30吨  
 建筑类型: 钢结构车间  
 建筑类型: 材料和现场指导安装 (钢结构, 彩色钢板, 门窗, 高强度螺栓, 给排水管等材料和指导安装)  
 签署日期: 2019年5月1日  
 运输截止日期: 2019年5月25日至2019年8月2日  
 发货批次: 2次  
 完成日期: 2019年10月13日





**Ghana color steel plate production plant**

Building area: 5208 square meters  
 Steel structure consumption: 152 tons  
 Building type: color steel plate production plant  
 Contract: we are responsible for design drawings, budget, deepening drawings, processing and manufacturing, booking and transportation; (Steel structure frame, skylight, door, window, wall/roof enclosure panel, sunlight tile, bolt, hemming and other full set of materials.)  
 Date of signature: 17 August 2019  
 Shipping deadline: October 9, 2019 to November 10, 2019  
 Shipment batch: 2 times

**加纳彩钢板生产工厂**

建筑面积: 5208平方米  
 钢结构用量: 152吨  
 建筑类型: 彩钢板生产工厂  
 合同: 我方负责设计图纸, 预算, 深化图纸, 加工制造, 订舱运输; (钢结构框架, 天窗, 门, 窗户, 墙/顶围护板材, 阳光瓦, 螺栓, 包边等全套材料  
 签署日期: 2019年8月17日  
 运输截止日期: 2019年10月9日至2019年11月10日  
 发货批次: 2次  
 完成日期: 2020年4月25日



**USA Commercial Cold Storage Warehouse**

Large commercial cold storage in the United States  
 Building area: 4500 square meters  
 Panels amount used: 9500 square meters  
 Building type: cold storage  
 Contract: We provide wall panels, ceiling panels, aluminum accessories, floors, cold storage doors, loading and unloading platforms, compressors, air coolers, copper pipes, etc  
 Date of signature: August 20, 2021  
 Shipping deadline: September 20, 2021 to October 15, 2021  
 Shipping batch: 3 times  
 Completion date: March 24, 2022

**美国大型商业冷库**

建筑面积: 4500平方米  
 板材用量: 9500平方米  
 建筑类型: 冷库  
 合同: 我方提供墙板, 吊顶板, 铝材附件, 地板, 冷库门, 装卸平台, 压缩机, 冷风机, 铜管等  
 签署日期: 2021年8月20日  
 运输截止日期: 2021年9月20日至2021年10月15日  
 发货批次: 3次  
 完成日期: 2022年3月24日



**Fiji Tea Processing Factory**

Building area: 450 square meters, with offices and mezzanine inside  
 Steel structure consumption: 112 tons  
 Building type: Tea processing plant  
 Contract: The customer provides drawings in line with Fiji design standards, and we are responsible for reviewing, improving design drawings, design renderings, deepening drawings, processing and manufacturing  
 Date of signature: 20 November 2019  
 Shipping deadline: January 5, 2020 to January 30, 2020  
 Shipment batch: 2 times

**斐济茶叶加工厂**

建筑面积: 450平方米, 内部有办公室和夹层  
 钢结构用量: 112吨  
 建筑类型: 茶叶加工厂  
 合同: 客户方提供符合斐济设计标准图纸, 我方负责审核, 完善设计图纸, 设计效果图, 深化图纸, 加工制造  
 签署日期: 2019年11月20日  
 运输截止日期: 2020年1月5日至2020年1月30日  
 发货批次: 2次



**Philippine Chicken Farm**

Building area: 1650 square meters \* 3 sets  
 Steel structure dosage: 46 tons \* 3 sets  
 Building type: steel structure chicken house  
 Contract: We provide design scheme, steel structure, wall panel, roof panel, door, accessories, installation drawing guidance to complete the installation  
 Date of signature: January 5, 2022  
 Shipping deadline: March 3, 2022 to April 15, 2022  
 Shipment batch: 2 times  
 Completion date: June 30, 2022

**菲律宾养鸡场**

建筑面积: 1650平方米\*3套  
 钢结构用量: 46吨\*3套  
 建筑类型: 钢结构鸡舍  
 合同: 我方提供设计方案, 钢构, 墙板, 顶板, 门, 附件, 安装图纸指导完成安装  
 签署日期: 2022年1月5日  
 运输截止日期: 2022年3月3日至2022年4月15日  
 发货批次: 2次  
 完成日期: 2022年6月30日





**Gabon TIMBER company Timber processing plant**

Construction Area: 4000 square meters  
 Steel structure dosage: 120T  
 Construction Type: Light steel structure Workshop  
 Contract way: To provide the required materials (steel, color plates, windows, doors, high-strength bolts, etc.)  
 Signing Date: August 2, 2016  
 Transport deadline: August 25, 2016-October 18, 2016  
 Completion Date: November 20, 2016

**加蓬TIMBER公司木材加工厂**

建筑面积: 4000平方米  
 钢结构用量: 120吨  
 建筑类型: 轻钢结构车间  
 合同方式: 提供所需的材料 (钢, 彩钢板, 门窗, 高强度螺栓等)  
 签署日期: 2016年8月2日  
 运输截止日期: 2016年8月25日至2016年10月18日  
 完成日期: 2016年11月20日



**Egyptian ARE group crystalline silicon solar equipment factory**

Construction Area: 15000 sqm  
 Steel structure dosage: 530 tons  
 Construction Type: Steel structure Workshop  
 Contract: Materials and on-site installation (steel structure, color steel plates, windows, doors, high-strength bolts, wire and cable, fire equipment, water supply and drainage pipes and other materials and installation)  
 Signing Date: June 1, 2015  
 Transport deadline: June 20, 2015-August 28, 2015  
 Shipment lot: 4 times  
 Completion Date: May 10, 2016

**埃及ARE集团晶硅太阳能设备厂**

建筑面积: 15000平方米  
 钢结构用量: 530吨  
 建筑类型: 钢结构车间  
 合同: 材料和现场安装 (钢结构, 彩色钢板, 门窗, 高强度螺栓, 电线电缆, 消防设备, 给排水管等材料)和安装)  
 签署日期: 2015年6月1日  
 运输截止日期: 2015年6月20日至2015年8月28日  
 发货批次: 4次  
 完成日期: 2016年5月10日



**Gabon SABIR IMPEX Company Timber processing plant**

Construction Area: 3200 sqm  
 Dosage of Steel Structure: 96 ton  
 Construction Type: Light steel structure Workshop  
 Contract way: To provide the required materials (steel, color plates, windows, doors, high-strength bolts, etc.)  
 Signing Date: September 5, 2016  
 Transport deadline: September 28, 2016-November 28, 2016  
 Completion Date: January 20, 2017

**加蓬SABIR IMPEX公司木材加工厂**

建筑面积: 3200平方米  
 钢结构用量: 96吨  
 建筑类型: 轻钢结构车间  
 合同方式: 提供所需的材料 (钢, 彩钢板, 门窗, 高强度螺栓等)  
 签署日期: 2016年9月5日  
 运输截止日期: 2016年9月28日至2016年11月28日  
 完成日期: 2017年1月20日



**Cameroon Processing Plant and Storage Center**

Construction area: 12336 square meters  
 Steel structure consumption: 456 tons  
 Building Type: Steel Structure Production Workshop  
 Contract: We assign a technical team to Cameroon to survey the site conditions, design drawings, deepen drawings, process and manufacture, book space for transportation; provide one-stop, steel structure, composite panel enclosure structure, parapet, two-story sandwich structure, sky Ditch, rainwater pipes, doors and windows, edging, bolts and other integral materials  
 Date signed: September 10, 2022  
 Completion Date: April 13, 2023

**喀麦隆加工厂和仓储中心**

建筑面积: 12336平方米  
 钢结构用量: 456吨  
 建筑类型: 钢结构生产车间  
 合同: 我方指派技术团队到喀麦隆现场勘测工地状况, 设计图纸, 深化图纸, 加工制造, 订舱运输; 提供一站式, 钢结构, 复合板围护结构, 女儿墙, 二层夹层结构, 天沟, 雨水管, 门窗, 包边, 螺栓等整体材料  
 签署日期: 2022年9月10日  
 完成日期: 2023年4月13日





**Uruguay Production Workshop and Storage Warehouse**

Construction area: 3600 square meters  
 Steel structure consumption: 120 tons  
 Building Type: Steel Structure Warehouse  
 Construction type: materials and on-site guidance for installation (steel structure, colored steel plates, doors and windows, high-strength bolts, cranes, water supply and drainage pipes and other materials and guidance for installation)  
 Date signed: November 13, 2016  
 Shipping deadline: December 5, 2016 to January 15, 2017  
 Shipment batch: 1 time  
 Completion date: March 20, 2017

乌拉圭生产车间和存储仓库  
 建筑面积: 3600平方米  
 钢结构用量: 120吨  
 建筑类型: 钢结构仓库  
 建筑类型: 材料和现场指导安装 (钢结构, 彩色钢板, 门窗, 高强度螺栓, 起重机, 给排水管等材料和指导安装)  
 签署日期: 2016年11月13日  
 运输截止日期: 2016年12月5日至2017年1月15日  
 发货批次: 1次



**Factory room and warehouse of Kosovo X-FORT Company**

Construction area: 5200 sqm  
 Dosage of Steel structure: 208 ton  
 Construction Type: Steel structure Workshop  
 Contract: Materials and on-site installation (steel structure, color steel plate, windows, doors, high-strength bolts, cranes, drainage pipes and other materials and installation)  
 Signing Date: June 5, 2014  
 Transport deadline: June 23, 2014-July 28, 2014  
 Shipment lot: 1 times  
 Completion Date: September 15, 2014

科索沃X-FORT公司的厂房和仓库  
 建筑面积: 5200平方米  
 钢结构用量: 208吨  
 建筑类型: 钢结构车间  
 合同: 材料和现场安装 (钢结构, 彩色钢板, 门窗, 高强度螺栓, 起重机, 排水管等材料 and 安装)  
 签署日期: 2014年6月5日  
 运输截止日期: 2014年6月23日至2014年7月28日  
 发货批次: 1次  
 完成日期: 2014年9月15日



**Angora Beverage Processing Plant**

Construction area: 2448 square meters  
 Steel structure consumption: 78 tons  
 Building Type: Beverage Processing Plant  
 Contract: We are responsible for designing the design drawings of all workshops in the factory area, deepening the drawings, processing and manufacturing, booking and transportation (steel structure, composite panel enclosure structure, sunshine tile, fan, bolts, wrapping and other complete materials)  
 Date signed: June 18, 2017  
 Shipping deadline: September 15, 2017 to October 25, 2017  
 Shipment batch: 2 times  
 Completion date: May 10, 2018

安哥拉饮料加工厂  
 建筑面积: 2448平方米  
 钢结构用量: 78吨  
 建筑类型: 饮料加工厂  
 合同: 我方负责设计厂区内所有厂房设计图纸, 深化图纸, 加工制造, 订舱运输 (钢结构, 复合板围护结构, 阳光瓦, 风机, 螺栓, 包边等全套材料)  
 签署日期: 2017年6月18日  
 运输截止日期: 2017年9月15日至2017年10月25日  
 发货批次: 2次  
 完成日期: 2018年5月10日



**India ASHAPURA Corporation Heavy Steel Plant**

Construction Area: 18000 sqm  
 Steel structure dosage: 720T  
 Type of construction: large heavy steel industrial plant  
 Contract Type: Materials and on-site installation (steel structure, color steel plate, windows, doors, high-strength bolts and other materials and installation construction)  
 Signing Date: December 5, 2015  
 Transport deadline: December 26, 2015-February 18, 2016  
 Shipment lot: 5 times  
 Completion time: June 28, 2016

印度ASHAPURA Corporation重钢厂  
 建筑面积: 18000平方米  
 钢结构用量: 720T  
 建筑类型: 大型重型钢铁工厂  
 合同类型: 材料和现场安装 (钢结构, 彩色钢板, 门窗, 高强度螺栓等材料 and 安装施工)  
 签署日期: 2015年12月5日  
 运输截止日期: 2015年12月26日至2016年2月18日  
 发货批次: 5次  
 完成时间: 2016年6月28日



# CUSTOMERS

## 我们的顾客

Our products have been exported to more than 120 countries in the world, and have been widely recognized.

我们的产品已经出口到世界上120多个国家，并得到了广泛的认可。

Mexico 墨西哥



Georgia 格鲁吉亚



Romania 罗马尼亚



Cameroon 喀麦隆



American 美国



Zimbabwe 津巴布韦



Thailand 泰国



Fiji 斐济



Chile 智利



Philippines 菲律宾



Brazil 巴西



Gabon 加蓬



Australia 澳大利亚



\* The above are only some photos of the company's customers  
\* 以上仅是公司部分顾客照片



# PARTNERS

合作伙伴



# ORDERING FLOW

订货流程

