

Bird Control

	NAME	Heavd Duty Whole SUS304 Bird Spikes		ITEM NO.:	HC1107-U2	
	MATERIAL	Iron Spray (Quality Promise: 3~5 Years For Normal Environment)			177g	
	LENGTH	STANDARD 50cm	EUR TYPE 100cm	USA TYPE 30cm		
	SPIKES FEATURES	QTY 40pcs	HEIGHT 110mm	PROTECT AREA 60mm	DIA 2mm	
	BASE FEATURES	BETWEEN PINS 2.25cm		THICKNESS 1mm	WIDTH 25mm	
	PACKING	Brown Carton <input type="checkbox"/>	With Box+Sticker <input type="checkbox"/>	Gift Box <input type="checkbox"/>	Head Card <input type="checkbox"/>	Blister Card <input type="checkbox"/>
	STANDARD PACKING	60Pcs/Ctn, Measure: 110x31x31cm, G.W/N.W: 18.7/17.7kgs				

	NAME	Whole Stainless Steel Bird Spikes		ITEM NO.:	HC1107-W4	
	MATERIAL	Iron Spray (Quality Promise: 3~5 Years For Normal Environment)			177g	
	LENGTH	STANDARD 50cm	USA TYPE 100cm	USA TYPE 30cm		
	SPIKES FEATURES	QTY 30pcs	HEIGHT 110mm	PROTECT AREA 140mm	DIA 2mm	
	BASE FEATURES	BETWEEN PINS 2.25cm		THICKNESS 1.84mm	WIDTH 25mm	
	PACKING	Brown Carton <input type="checkbox"/>	With Box+Sticker <input type="checkbox"/>	Gift Box <input type="checkbox"/>	Head Card <input type="checkbox"/>	Blister Card <input type="checkbox"/>
	STANDARD PACKING	60Pcs/Ctn, Measure: 110x31x31cm, G.W/N.W: 18.7/17.7kgs				

	NAME	Heavd Duty Whole SUS304 Bird Spikes		ITEM NO.:	HC1109-W4	
	MATERIAL	Iron Spray (Quality Promise: 3~5 Years For Normal Environment)			258g	
	LENGTH	STANDARD 50cm	EUR TYPE 100cm	USA TYPE 30cm		
	SPIKES FEATURES	QTY 40pcs	HEIGHT 110mm	PROTECT AREA 150mm	DIA 2.5mm	
	BASE FEATURES	BETWEEN PINS 2.27cm		THICKNESS 2.5mm	WIDTH 30.5mm	
	PACKING	Brown Carton <input type="checkbox"/>	With Box+Sticker <input type="checkbox"/>	Gift Box <input type="checkbox"/>	Head Card <input type="checkbox"/>	Blister Card <input type="checkbox"/>
	STANDARD PACKING	50Pcs/Ctn, Measure: 110x31x31cm, G.W/N.W: 16.5/15.5kgs				

	NAME	Easy Steel Bird Spikes		ITEM NO.:	HC1109-MGW4S	
	MATERIAL	Iron Spray (Quality Promise: 3~5 Years For Normal Environment)			258g	
	LENGTH	STANDARD 50cm	EUR TYPE 100cm	USA TYPE 30cm		
	SPIKES FEATURES	QTY 40pcs	HEIGHT 110mm	PROTECT AREA 150mm	DIA 2mm	
	BASE FEATURES	BETWEEN PINS 2.27cm		THICKNESS 2.5mm	WIDTH 30.5mm	
	PACKING	Brown Carton <input type="checkbox"/>	With Box+Sticker <input type="checkbox"/>	Gift Box <input type="checkbox"/>	Head Card <input type="checkbox"/>	Blister Card <input type="checkbox"/>
	STANDARD PACKING	50Pcs/Ctn, Measure: 54x31x31cm, G.W/N.W: 16.5/15.5kgs				

	NAME	Easy Steel Bird Spikes		ITEM NO.:	HC1109-MPW4S	
	MATERIAL	Iron Spray (Quality Promise: 3~5 Years For Normal Environment)			258g	
	LENGTH	STANDARD 50cm	EUR TYPE 100cm	USA TYPE 30cm		
	SPIKES FEATURES	QTY 40pcs	HEIGHT 110mm	PROTECT AREA 150mm	DIA 2mm	
	BASE FEATURES	BETWEEN PINS 2.27cm		THICKNESS 2.5mm	WIDTH 30.5mm	
	PACKING	Brown Carton <input type="checkbox"/>	With Box+Sticker <input type="checkbox"/>	Gift Box <input type="checkbox"/>	Head Card <input type="checkbox"/>	Blister Card <input type="checkbox"/>
	STANDARD PACKING	50Pcs/Ctn, Measure: 110x31x31cm, G.W/N.W: 16.5/15.5kgs				



DO IT BY YOUR HANDS





For many years, relying on high-level expertise and the mature technology. teamwork have been rapidly rising in the field of bird-cage & pest control products manufacturing .Depending on science and technology for development,consistently providing the satisfying new products to customers. Recently,we have cooperated with many international well-known enterprises and developed a variety of products for pest control. Meanwhile, we assist many killing insects company from home and abroad in developing new business.

Our company has more than ten years experience of the electrostatic spraying process,making use of the modern management mode,adopting the advanced producing equipment,bringing in various of spot welding,row welding, butt welding,argon arc welding machines,more than 20sets,various types of punchers,15sets,various types of adjustable screw machine,15sets,hydraulic press machine,2sets,bending machine,1set,plate shearing machine,1set.various types of injection molding machine,including upright and horizontal,more than 10sets,electrostatic spraying production line,1set and some other assisted machines.Committing ourselves to the principle of quality first and good after sales, we provide the customers exquisite and novel products.

The company's products are mainly exported to European and American countries,and we have many oversea distributors for our products such as in Japan,Germany,The United Kingdom ,Thailand,America,Canada and so on.Our domestic products are all for export to the domestic or inventory for foreign customers .Quality has been in a top position in the domestic same industry.

Hardware Products Co,Ltd belongs to registered into 100m! in May, 2011. which is a manufacturing enterprise integrating R&D,Manufacturing and Marketing.The company specializes in R&D, producing various of anti-bird products,rodent control products,pet cages,sport equipment & frame and so on.

Industry Co., Limited, was founded in 2006,and officially Industrial Park, China, city

The company owns more than one thousand various types of parrot cages, decorative bird cages, breeding cages and cages for dog, cat & hamster,etc which are best-selling domestically and abroad. Meanwhile,we sell all kinds of live-trap equipment to eliminate the pests,such as anti -bird spikes,bird-expeller,bird scarer balloon,mouse trap,-cat-trap cage,foldable cage,bait station,mouse-sticking board,fly-sticking board,and the equipment to eliminate the cockroach,mosquito and fly,etc.

Our company's goal:
People-oriented,scientific management,initiative,continuous innovation.
The company's development objective:
Ten hard years like a day,Striving to create value.
Welcome old and new customers.

HAIER

BIRD CONTRIL

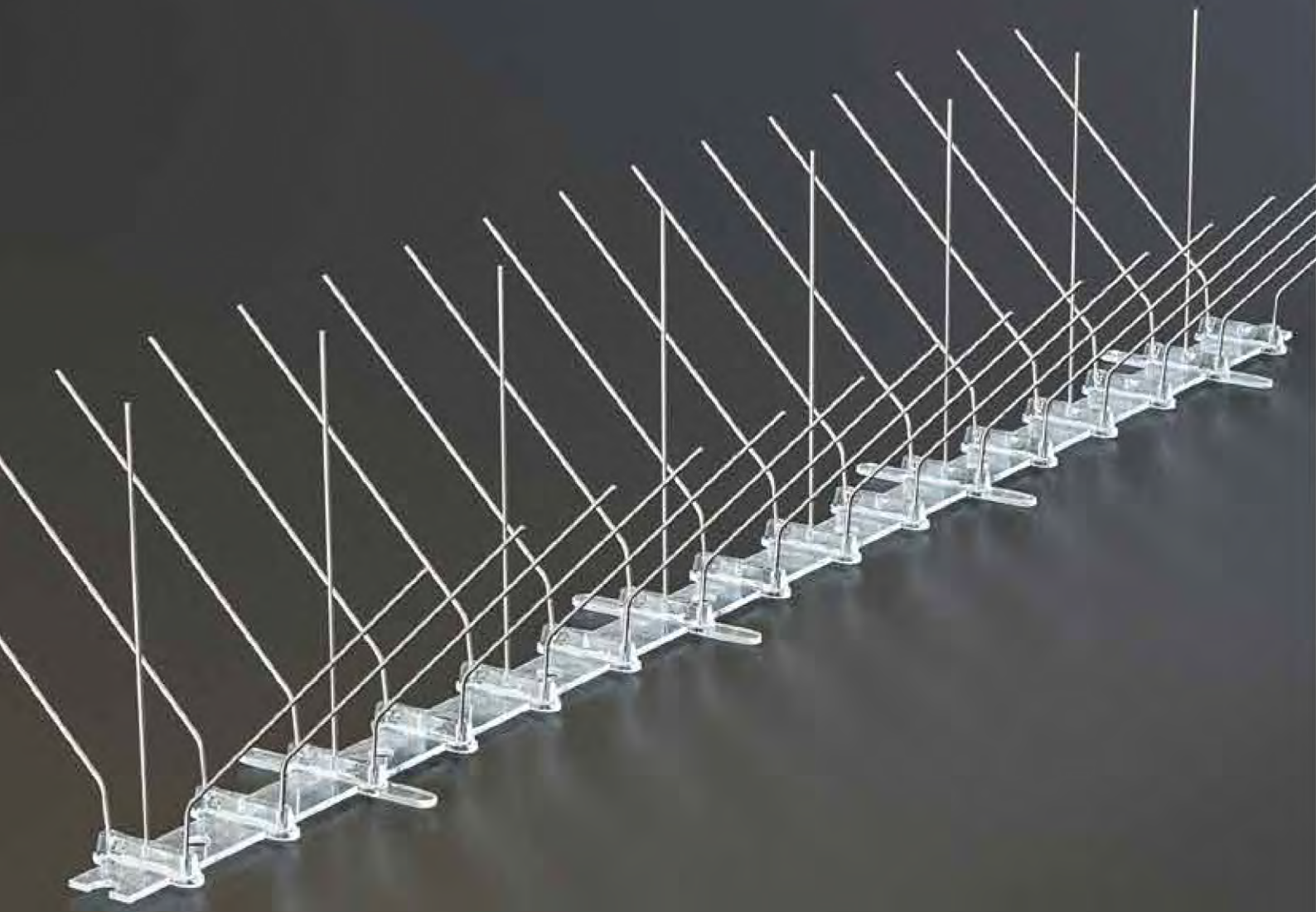

Sole Distributor Applying Bird Control Spikes(Patent: 201120370107.7)

Used For:

- Keeps pets in-stops animals & intruders from jumping fences.
- Stops cats & possums from climbing up trees.
- Prevents birds from destroying TV aerials and other structures.
- Cover all possible landing areas on buildings with Haierc Bird Spikes.

Advantages of Bird Spikes:

- Long lasting,humane,nearly invisible bird control products
- Works from light to heavy bird pressure
- Extremely strong and versatile bird control products
- Easily glued or screwed to any substrate

HC1101Series Technical Features

BASE	UV TeatmentPC	SPECIAL CHOICEN	Normal PC
BASE LENGTH	Normal 50cm	SPECIAL CHOICE25	25cm,30cm(1ft),2ft(60cm)Etc
PIN MATERUAL	NormalSUS304	SPECIAL CHOICE st	SUS430,SUS201,SUS316,Etc
PIN SPECFHICATION	HEIGHT 110mm	DIA 1.3mm	
DISTANCE BETWEEN PINS	2.5cm	BASE THICKNESS 2.1mm	BASE WIDTH 20mm/40mm
NORMAL PACKING	5ply Brown Corugated Cartons(Bulk Packing)		
SPECIAL PACKING	Blister Card	Gift Box	DIY Blister Card White Box With Sticker

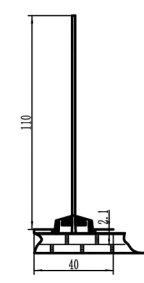

1101-M1

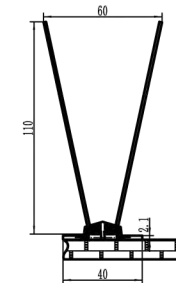

1101-U2

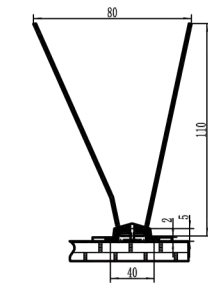

1101-R2

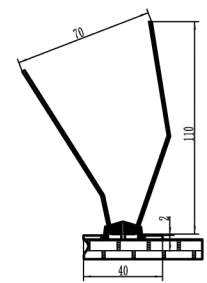

1101-H2

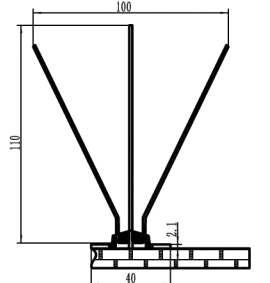

1101-W3

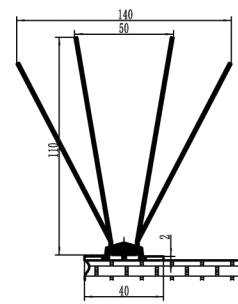

1101-W4

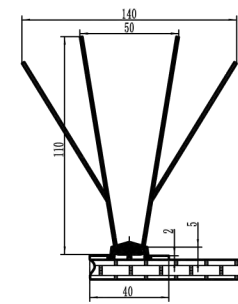

1101-W4S

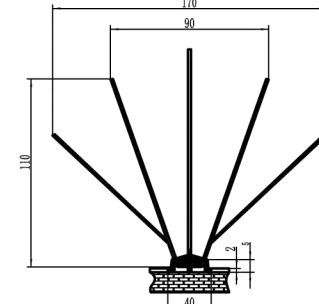

1101-W5

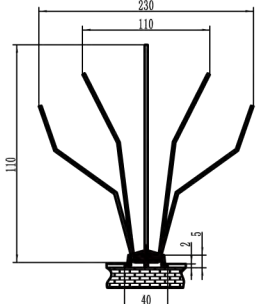

1101-W5S







NAME	T Type Bird Spikes		ITEM NO.:	HC1101-T1
MATERIAL	Polycarbonate(UV)+SUS304 (Quality Promise: 3~5 Years For Normal Environment) 46g			
LENGTH	STANDARD 50cm	USA TYPE 60cm	USA TYPE 30cm	DIY TYPE25cm
SPIKES FEATURES	QTY 20pcs	HEIGHT 110mm	PROTECT AREA 20mm	DIA 1.3mm
BASE FEATURES	BETWEEN PINS 2.5cm		THICKNESS 2.1mm	WIDTH 20/40mm
PACKING	Brown Carton <input type="checkbox"/>	With Box+Sticker <input type="checkbox"/>	Gift Box <input type="checkbox"/>	Head Card <input type="checkbox"/>
STANDARD PACKING	100Pcs/Ctn,Measure:55x33x30cm,G.W/N.W:5.6/4.6kgs			
AMAZON 10 FT PACK	10Pcs/Post Box,12Boxes/Ctn,Box Size:33x7.5x20cm,Measure:63x35x34cm,G.W/N.W:5/4kgs			



NAME	W Type Bird Spikes		ITEM NO.:	HC1101-W3
MATERIAL	Polycarbonate(UV)+SUS304 (Quality Promise: 3~5 Years For Normal Environment) 59g			
LENGTH	STANDARD 50cm	USA TYPE 60cm	USA TYPE 30cm	DIY TYPE25cm
SPIKES FEATURES	QTY 30pcs	HEIGHT 110mm	PROTECT AREA 100mm	DIA 1.3mm
BASE FEATURES	BETWEEN PINS 2.5cm		THICKNESS 2.1mm	WIDTH 20/40mm
PACKING	Brown Carton <input type="checkbox"/>	With Box+Sticker <input type="checkbox"/>	Gift Box <input type="checkbox"/>	Head Card <input type="checkbox"/>
STANDARD PACKING	120Pcs/Ctn, Measure: 55x37x40cm , G.W/N.W:8.1/7.1kgs			
AMAZON 10 FT PACK	10Pcs/Post Box, 12Boxes/Ctn, Box Size:15.5x13.5x33cm,Measure:49x35x57cm G.W/N.W:6/5kgs			



NAME	U Type Bird Spikes		ITEM NO.:	HC1101-U2
MATERIAL	Polycarbonate(UV)+SUS304 (Quality Promise: 3~5 Years For Normal Environment) 48g			
LENGTH	STANDARD 50cm	USA TYPE 60cm	USA TYPE 30cm	DIY TYPE25cm
SPIKES FEATURES	QTY 20pcs	HEIGHT 110mm	PROTECT AREA 60mm	DIA 1.3mm
BASE FEATURES	BETWEEN PINS 2.5cm		THICKNESS 2.1mm	WIDTH 20/40mm
PACKING	Brown Carton <input type="checkbox"/>	With Box+Sticker <input type="checkbox"/>	Gift Box <input type="checkbox"/>	Head Card <input type="checkbox"/>
STANDARD PACKING	100Pcs/Ctn,Measure: 55x33x30cm,G.W/N.W:6/5kgs			
AMAZON 10 FT PACK	10Pcs/Post Box,12Boxes/Ctn, Box Size:33x7.5x20cm,Measure:63x35x34cm,G.W/N.W:5/4kgs			



NAME	W Type Bird Spikes		ITEM NO.:	HC1101-W4
MATERIAL	Polycarbonate(UV)+SUS304 (Quality Promise: 3~5 Years For Normal Environment) 75g			
LENGTH	STANDARD 50cm	USA TYPE 60cm	USA TYPE 30cm	DIY TYPE25cm
SPIKES FEATURES	QTY 40pcs	HEIGHT 110mm	PROTECT AREA 140mm	DIA 1.3mm
BASE FEATURES	BETWEEN PINS 2.5cm		THICKNESS 2.1mm	WIDTH 20/40mm
PACKING	Brown Carton <input type="checkbox"/>	With Box+Sticker <input type="checkbox"/>	Gift Box <input type="checkbox"/>	Head Card <input type="checkbox"/>
STANDARD PACKING	120Pcs/Ctn, Measure:55x39x40cm, G.W/N.W:10/9kgs			
AMAZON 10 FT PACK	10Pcs/Post Box, 12Boxes/Ctn, Box Size:20x13.5x33cm,Measure:63x35x57cm,G.W/N.W:7/6kgs			



NAME	U Type Bird Spikes For Sparrow & Little Bird		ITEM NO.:	HC1101-U2S
MATERIAL	Polycarbonate(UV)+SUS304 (Quality Promise: 3~5 Years For Normal Environment) 71g			
LENGTH	STANDARD 50cm	USA TYPE 60cm	USA TYPE 30cm	DIY TYPE25cm
SPIKES FEATURES	QTY 40pcs	HEIGHT 110mm	PROTECT AREA 60mm	DIA 1.3mm
BASE FEATURES	BETWEEN PINS 2.5cm		THICKNESS 2.1mm	WIDTH 20/40mm
PACKING	Brown Carton <input type="checkbox"/>	With Box+Sticker <input type="checkbox"/>	Gift Box <input type="checkbox"/>	Head Card <input type="checkbox"/>
STANDARD PACKING	100Pcs/Ctn,Measure: 55x33x30cm,G.W/N.W:8.1/7.1kgs			
AMAZON 10 FT PACK	10Pcs/Post Box,12Boxes/Ctn, Box Size:33x7.5x20cm,Measure:63x35x34cm,G.W/N.W:7/6kgs			

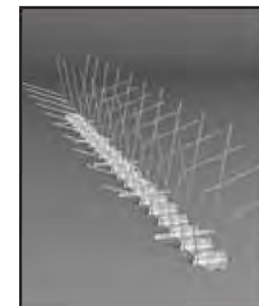

NAME	W Type Bird Spikes		ITEM NO.:	HC1101-W4S
MATERIAL	Polycarbonate(UV)+SUS304 (Quality Promise: 3~5 Years For Normal Environment) 75g			
LENGTH	STANDARD 50cm	USA TYPE 60cm	USA TYPE 30cm	DIY TYPE25cm
SPIKES FEATURES	QTY 40pcs	HEIGHT 110mm	PROTECT AREA 150mm	DIA 1.3mm
BASE FEATURES	BETWEEN PINS 2.5cm		THICKNESS 2.1mm	WIDTH 20/40mm
PACKING	Brown Carton <input type="checkbox"/>	With Box+Sticker <input type="checkbox"/>	Gift Box <input type="checkbox"/>	Head Card <input type="checkbox"/>
STANDARD PACKING	100Pcs/Ctn, Measure:55x39x40cm, G.W/N.W:8.5/7.5kgs			
AMAZON 10 FT PACK	10Pcs/Post Box, 12Boxes/Ctn, Box Size:19.5x13.5x33cm,Measure:61x35x57cm,G.W/N.W:7/6kgs			

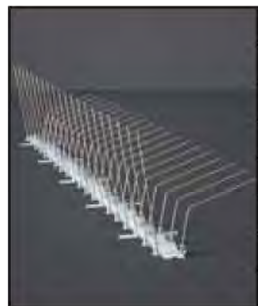

NAME	R Type Bird Spikes		ITEM NO.:	HC1101-R2
MATERIAL	Polycarbonate(UV)+SUS304 (Quality Promise: 3~5 Years For Normal Environment) 48g			
LENGTH	STANDARD 50cm	USA TYPE 60cm	USA TYPE 30cm	DIY TYPE25cm
SPIKES FEATURES	QTY 20pcs	HEIGHT 110mm	PROTECT AREA 80mm	DIA 1.3mm
BASE FEATURES	BETWEEN PINS 2.5cm		THICKNESS 2.1mm	WIDTH 20/40mm
PACKING	Brown Carton <input type="checkbox"/>	With Box+Sticker <input type="checkbox"/>	Gift Box <input type="checkbox"/>	Head Card <input type="checkbox"/>
STANDARD PACKING	100Pcs/Ctn,Measure: 55x40x33cm,G.W/N.W:6/5kgs			
AMAZON 10 FT PACK				



NAME	W Type Bird Spikes		ITEM NO.:	HC1101-W5
MATERIAL	Polycarbonate(UV)+SUS304 (Quality Promise: 3~5 Years For Normal Environment) 83g			
LENGTH	STANDARD 50cm	USA TYPE 60cm	USA TYPE 30cm	DIY TYPE25cm
SPIKES FEATURES	QTY 50pcs	HEIGHT 110mm	PROTECT AREA 170mm	DIA 1.3mm
BASE FEATURES	BETWEEN PINS 2.5cm		THICKNESS 2.1mm	WIDTH 20/40mm
PACKING	Brown Carton <input type="checkbox"/>	With Box+Sticker <input type="checkbox"/>	Gift Box <input type="checkbox"/>	Head Card <input type="checkbox"/>
STANDARD PACKING	120Pcs/Ctn, Measure: 55x39x40cm, G.W/N.W:11/10kgs			
AMAZON 10 FT PACK	10Pcs/Post Box, 12Boxes/Ctn, Box Size:19.5x15x33cm,Measure:62.5x33.5x61.5cm,G.W/N.W:7/6kgs			



NAME	H Type Bird Spikes		ITEM NO.:	HC1101-H2
MATERIAL	Polycarbonate(UV)+SUS304 (Quality Promise: 3~5 Years For Normal Environment) 48g			
LENGTH	STANDARD 50cm	USA TYPE 60cm	USA TYPE 30cm	DIY TYPE25cm
SPIKES FEATURES	QTY 20pcs	HEIGHT 110mm	PROTECT AREA 70mm	DIA 1.3mm
BASE FEATURES	BETWEEN PINS 2.5cm		THICKNESS 2.1mm	WIDTH 20/40mm
PACKING	Brown Carton <input type="checkbox"/>	With Box+Sticker <input type="checkbox"/>	Gift Box <input type="checkbox"/>	Head Card <input type="checkbox"/>
STANDARD PACKING	100Pcs/Ctn,Measure:55x40x33cm,G.W/N.W:6/5kgs			
AMAZON 10 FT PACK				

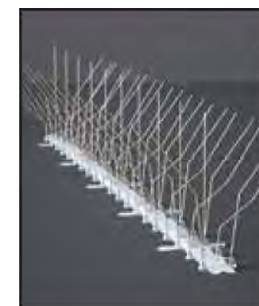

NAME	W Type Bird Spikes		ITEM NO.:	HC1101-W5S
MATERIAL	Polycarbonate(UV)+SUS304 (Quality Promise: 3~5 Years For Normal Environment) 83g			
LENGTH	STANDARD 50cm	USA TYPE 60cm	USA TYPE 30cm	DIY TYPE25cm
SPIKES FEATURES	QTY 50pcs	HEIGHT 110mm	PROTECT AREA 180mm	DIA 1.3mm
BASE FEATURES	BETWEEN PINS 2.5cm		THICKNESS 2.1mm	WIDTH 20/40mm
PACKING	Brown Carton <input type="checkbox"/>	With Box+Sticker <input type="checkbox"/>	Gift Box <input type="checkbox"/>	Head Card <input type="checkbox"/>
STANDARD PACKING	120Pcs/Ctn, Measure: 55x50x40cm, G.W/N.W:11/10kgs			
AMAZON 10 FT PACK	10Pcs/Post Box, 12Boxes/Ctn, Box Size:21x15x33cm,Measure:65x61.5x35.5cm,G.W/N.W:9.5/8.5kgs			





BIRD CONTROL

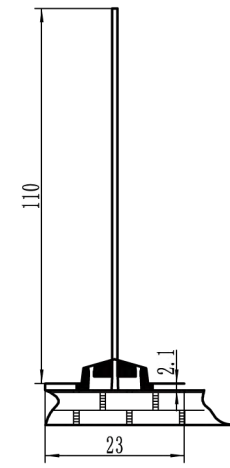

1102-T1

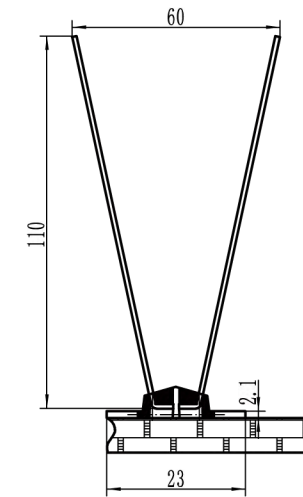

1102-U2

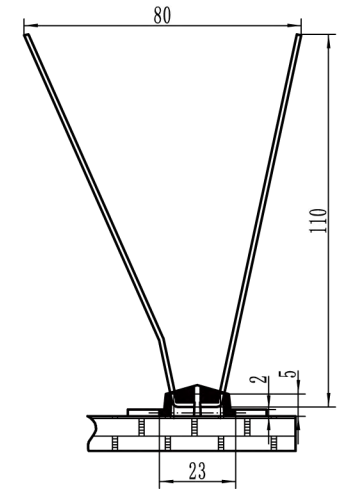

1102-R2

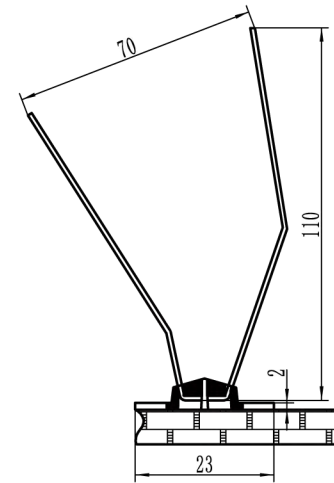

1102-H2

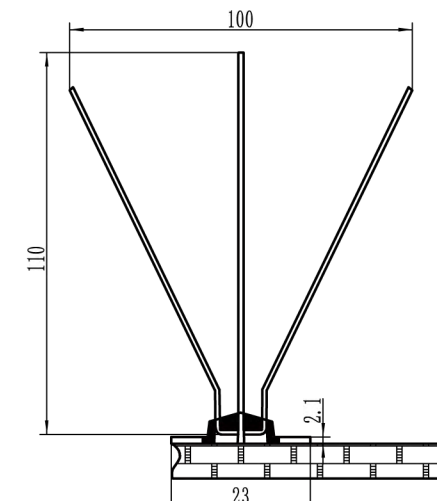

1102-W3

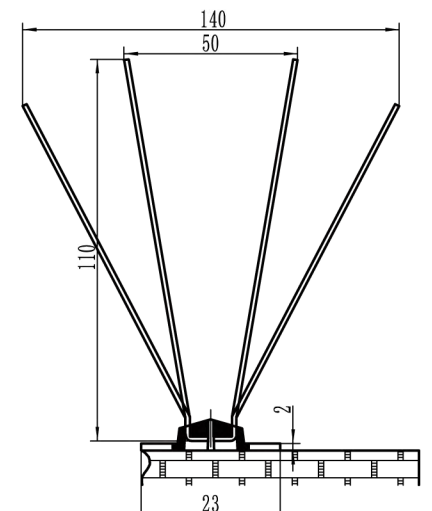

1102-W4

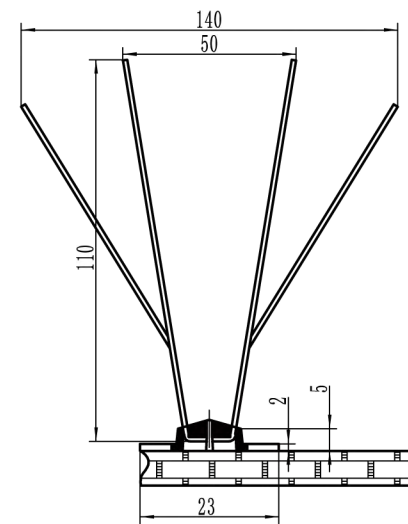

1102-W4S

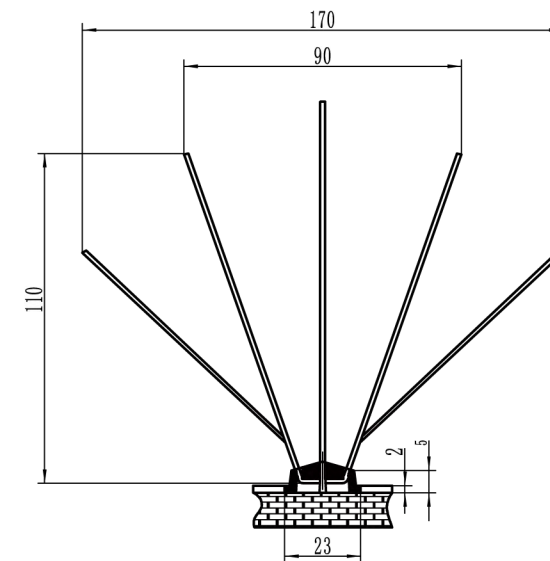

1102-W5

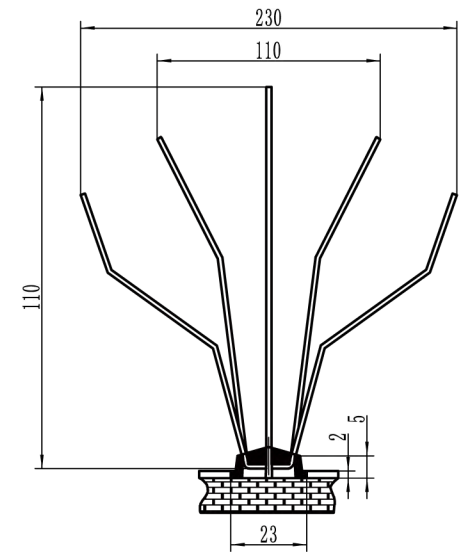

1102-W5S







NAME	EUR Standard Type Bird Spikes		ITEM NO.:	HC1102-M1
MATERIAL	Polycarbonate(UV)+SUS304 (Quality Promise: 3~5 Years For Normal Environment) 52g			
LENGTH	STANDARD 50cm	USA TYPE 60cm	USA TYPE 30cm	DIY TYPE25cm
SPIKES FEATURES	QTY 20pcs	HEIGHT 110mm	PROTECT AREA 20mm	DIA 1.3mm
BASE FEATURES	BETWEEN PINS 2.5cm		THICKNESS 6mm	WIDTH 12/23mm
PACKING	Brown Carton <input type="checkbox"/>	With Box+Sticker <input type="checkbox"/>	Gift Box <input type="checkbox"/>	Head Card <input type="checkbox"/>
STANDARD PACKING	150Pcs/Ctn, Measure:55x46x32cm , G.W/N.W:8.8/7.8kgs			
AMAZON 10 FT PACK	10Pcs/Post Box, 16Boxes/Ctn, Measure:66x39x45cm G.W/N.W:10/9kgs			



NAME	EUR Standard Type Bird Spikes		ITEM NO.:	HC1102-W3
MATERIAL	Polycarbonate(UV)+SUS304 (Quality Promise: 3~5 Years For Normal Environment) 76g			
LENGTH	STANDARD 50cm	USA TYPE 60cm	USA TYPE 30cm	DIY TYPE25cm
SPIKES FEATURES	QTY 40pcs	HEIGHT 110mm	PROTECT AREA 100mm	DIA 1.3mm
BASE FEATURES	BETWEEN PINS 2.5cm		THICKNESS 6mm	WHIDTH 12/23mm
PACKING	Brown Carton <input type="checkbox"/>	With Box+Sticker <input type="checkbox"/>	Gift Box <input type="checkbox"/>	Head Card <input type="checkbox"/>
STANDARD PACKING	100Pcs/Ctn, Measure: 55x42x52m, G.W/N.W:8.6/7.6kgs			
AMAZON 10 FT PACK	10Pcs/Post Box			



NAME	EUR Standard Type Bird Spikes		ITEM NO.:	HC1102-U2
MATERIAL	Polycarbonate(UV)+SUS304 (Quality Promise: 3~5 Years For Normal Environment) 52g			
LENGTH	STANDARD 50cm	USA TYPE 60cm	USA TYPE 30cm	DIY TYPE25cm
SPIKES FEATURES	QTY 20pcs	HEIGHT 110mm	PROTECT AREA 60mm	DIA 1.3mm
BASE FEATURES	BETWEEN PINS 2.5cm		THICKNESS 6mm	WHIDTH 12/23mm
PACKING	Brown Carton <input type="checkbox"/>	With Box+Sticker <input type="checkbox"/>	Gift Box <input type="checkbox"/>	Head Card <input type="checkbox"/>
STANDARD PACKING	100Pcs/Ctn, Measure: 55x53x30cm, G.W/N.W:6.2/5.2kgs			
AMAZON 10 FT PACK	10Pcs/Post Box, 16Boxes/Ctn, Measure:66x39x45cm G.W/N.W:10/9kgs			



NAME	EUR Standard Type Bird Spikes		ITEM NO.:	HC1102-V1
MATERIAL	Polycarbonate(UV)+SUS304 (Quality Promise: 3~5 Years For Normal Environment) 65g			
LENGTH	STANDARD 50cm	USA TYPE 60cm	USA TYPE 30cm	DIY TYPE25cm
SPIKES FEATURES	QTY 30pcs	HEIGHT 110mm	PROTECT AREA 70mm	DIA 1.3mm
BASE FEATURES	BETWEEN PINS 2.5cm		THICKNESS 6mm	WHIDTH 12/23mm
PACKING	Brown Carton <input type="checkbox"/>	With Box+Sticker <input type="checkbox"/>	Gift Box <input type="checkbox"/>	Head Card <input type="checkbox"/>
STANDARD PACKING	100Pcs/Ctn, Measure: 55x42x52cm, G.W/N.W:7.5/6.5kgs			
AMAZON 10 FT PACK	10Pcs/Post Box			



NAME	EUR Standard Type Bird Spikes		ITEM NO.:	HC1102-U2S
MATERIAL	Polycarbonate(UV)+SUS304 (Quality Promise: 3~5 Years For Normal Environment) 72g			
LENGTH	STANDARD 50cm	USA TYPE 60cm	USA TYPE 30cm	DIY TYPE25cm
SPIKES FEATURES	QTY 40pcs	HEIGHT 110mm	PROTECT AREA 60mm	DIA 1.3mm
BASE FEATURES	BETWEEN PINS 2.5cm		THICKNESS 6mm	WHIDTH 12/23mm
PACKING	Brown Carton <input type="checkbox"/>	With Box+Sticker <input type="checkbox"/>	Gift Box <input type="checkbox"/>	Head Card <input type="checkbox"/>
STANDARD PACKING	100Pcs/Ctn, Measure: 55x53x30cm, G.W/N.W:8.2/7.2kgs			
AMAZON 10 FT PACK	10Pcs/Post Box, 16Boxes/Ctn, Measure66x39x45cm G.W/N.W:13/12kgs			



NAME	U Type Bird Spikes		ITEM NO.:	HC1102-V2
MATERIAL	Polycarbonate(UV)+SUS304 (Quality Promise: 3~5 Years For Normal Environment) 76g			
LENGTH	STANDARD 50cm	USA TYPE 60cm	USA TYPE 30cm	DIY TYPE25cm
SPIKES FEATURES	QTY 40pcs	HEIGHT 110mm	PROTECT AREA 100mm	DIA 1.3mm
BASE FEATURES	BETWEEN PINS 2.5cm		THICKNESS 6mm	WHIDTH 12/23mm
PACKING	Brown Carton <input type="checkbox"/>	With Box+Sticker <input type="checkbox"/>	Gift Box <input type="checkbox"/>	Head Card <input type="checkbox"/>
STANDARD PACKING	100Pcs/Ctn, Measure: 55x42x52cm, G.W/N.W:8.6/7.6kgs			
AMAZON 10 FT PACK	10Pcs/Post Box			

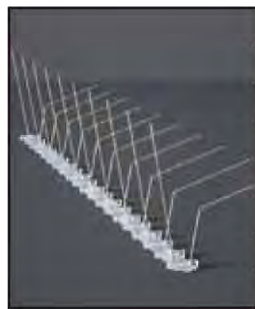

NAME	EUR Standard Type Bird Spikes		ITEM NO.:	HC1102-R2
MATERIAL	Polycarbonate(UV)+SUS304 (Quality Promise: 3~5 Years For Normal Environment) 52g			
LENGTH	STANDARD 50cm	USA TYPE 60cm	USA TYPE 30cm	DIY TYPE25cm
SPIKES FEATURES	QTY 40pcs	HEIGHT 110mm	PROTECT AREA 80mm	DIA 1.3mm
BASE FEATURES	BETWEEN PINS 2.5cm		THICKNESS 6mm	WHIDTH 12/23mm
PACKING	Brown Carton <input type="checkbox"/>	With Box+Sticker <input type="checkbox"/>	Gift Box <input type="checkbox"/>	Head Card <input type="checkbox"/>
STANDARD PACKING	100Pcs/Ctn, Measure: 55x53x30cm, G.W/N.W:6.2/5.2kgs			
AMAZON 10 FT PACK	10Pcs/Post Box, 16Boxes/Ctn, Measure66x39x45cm G.W/N.W:10/9kgs			



NAME	EUR Standard Type Bird Spikes		ITEM NO.:	HC1102-W4
MATERIAL	Polycarbonate(UV)+SUS304 (Quality Promise: 3~5 Years For Normal Environment) 76g			
LENGTH	STANDARD 50cm	USA TYPE 60cm	USA TYPE 30cm	DIY TYPE25cm
SPIKES FEATURES	QTY 40pcs	HEIGHT 110mm	PROTECT AREA 140mm	DIA 1.3mm
BASE FEATURES	BETWEEN PINS 2.5cm		THICKNESS 6mm	WHIDTH 12/23mm
PACKING	Brown Carton <input type="checkbox"/>	With Box+Sticker <input type="checkbox"/>	Gift Box <input type="checkbox"/>	Head Card <input type="checkbox"/>
STANDARD PACKING	100Pcs/Ctn, Measure: 55x39x40cm, G.W/N.W:8.6/7.6kgs			
AMAZON 10 FT PACK	10Pcs/Post Box			

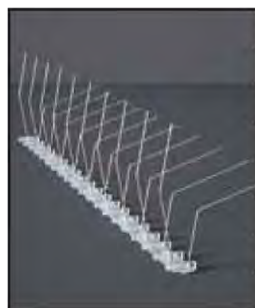

NAME	EUR Standard Type Bird Spikes		ITEM NO.:	HC1102-H2
MATERIAL	Polycarbonate(UV)+SUS304 (Quality Promise: 3~5 Years For Normal Environment) 52g			
LENGTH	STANDARD 50cm	USA TYPE 60cm	USA TYPE 30cm	DIY TYPE25cm
SPIKES FEATURES	QTY 40pcs	HEIGHT 110mm	PROTECT AREA 70mm	DIA 1.3mm
BASE FEATURES	BETWEEN PINS 2.5cm		THICKNESS 6mm	WHIDTH 12/23mm
PACKING	Brown Carton <input type="checkbox"/>	With Box+Sticker <input type="checkbox"/>	Gift Box <input type="checkbox"/>	Head Card <input type="checkbox"/>
STANDARD PACKING	100Pcs/Ctn, Measure: 55x53x30cm, G.W/N.W:6.2/5.2kgs			
AMAZON 10 FT PACK	10Pcs/Post Box, 16Boxes/Ctn, Measure:66x39x45cm G.W/N.W:10/9kgs			

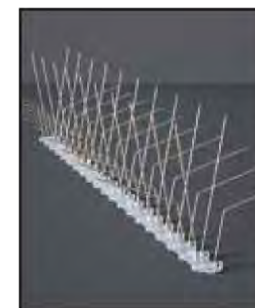

NAME	EUR Standard Type Bird Spikes		ITEM NO.:	HC1102-W4S
MATERIAL	Polycarbonate(UV)+SUS304 (Quality Promise: 3~5 Years For Normal Environment) 76g			
LENGTH	STANDARD 50cm	USA TYPE 60cm	USA TYPE 30cm	DIY TYPE25cm
SPIKES FEATURES	QTY 40pcs	HEIGHT 110mm	PROTECT AREA 150mm	DIA 1.3mm
BASE FEATURES	BETWEEN PINS 2.5cm		THICKNESS 6mm	WHIDTH 12/23mm
PACKING	Brown Carton <input type="checkbox"/>	With Box+Sticker <input type="checkbox"/>	Gift Box <input type="checkbox"/>	Head Card <input type="checkbox"/>
STANDARD PACKING	100Pcs/Ctn, Measure: 55x39x40cm, G.W/N.W:8.6/7.6kgs			
AMAZON 10 FT PACK	10Pcs/Post Box			







NAME	EUR Standard Type Bird Spikes		ITEM NO.:	HC1102-W5
MATERIAL	Polycarbonate(UV)+SUS304 (Quality Promise: 3~5 Years For Normal Environment) 89g			
LENGTH	STANDARD 50cm	USA TYPE 60cm	USA TYPE 30cm	DIY TYPE25cm
SPIKES FEATURES	QTY 50pcs	HEIGHT 110mm	PROTECT AREA 170mm	DIA 1.3mm
BASE FEATURES	BETWEEN PINS 2.5cm		THICKNESS 6mm	WHIDTH 12/23mm
PACKING	Brown Carton <input type="checkbox"/>	With Box+Sticker <input type="checkbox"/>	Gift Box <input type="checkbox"/>	Head Card <input type="checkbox"/>
STANDARD PACKING	100Pcs/Ctn, Measure: 55x50x52cm, G.W/N.W:9.9/8.9kgs			
AMAZON 10 FT PACK	10Pcs/Post Box, 16Boxes/Ctn,Box Size:25x15x35cm, Measure:62.5x62.5x63cm G.W/N.W:15/14kgs			



NAME	Whole Plastic Bird Spikes		ITEM NO.:	HC1118-W3
MATERIAL	Whole Polycarbonate(UV) (Quality Promise: 7~10 Years For Normal Environment) 35g			
LENGTH	STANDARD 25cm			
SPIKES FEATURES	QTY 18pcs	HEIGHT 110mm	PROTECT AREA 150mm	DIA 3mm
BASE FEATURES	BETWEEN PINS 2.5cm		THICKNESS 2.9mm	WIDTH15/26mm
PACKING	Brown Carton <input type="checkbox"/>	With Box+Sticker <input type="checkbox"/>	Gift Box <input type="checkbox"/>	Head Card <input type="checkbox"/>
STANDARD PACKING	120Pcs/Ctn, Measure: 55X29X45cm, G.W/N.W:5.2/4.2kgs			
AMAZON PACK	10Pcs/Post Box,12Boxes/Ctn, Box Size:15x12.5x27.5cm,Measure:48x29.5x52cm G.W/N.W:6/5kgs			



NAME	EUR Standard Type Bird Spikes		ITEM NO.:	HC1102-W5S
MATERIAL	Polycarbonate(UV)+SUS304 (Quality Promise: 3~5 Years For Normal Environment) 101g			
LENGTH	STANDARD 50cm	USA TYPE 60cm	USA TYPE 30cm	DIY TYPE25cm
SPIKES FEATURES	QTY 60pcs	HEIGHT 110mm	PROTECT AREA 180mm	DIA 1.3mm
BASE FEATURES	BETWEEN PINS 2.5cm		THICKNESS 6mm	WHIDTH 12/23mm
PACKING	Brown Carton <input type="checkbox"/>	With Box+Sticker <input type="checkbox"/>	Gift Box <input type="checkbox"/>	Head Card <input type="checkbox"/>
STANDARD PACKING	100pcs/CTN, Measure: 55x55x52cm, G.W/N.W:11.1/10.1kgs			
AMAZON 10 FT PACK	10pcs/Post Box			



NAME	America Standard Type Bird Spikes		ITEM NO.:	HC1108-W3
MATERIAL	Polycarbonate(UV)+SUS304 (Quality Promise: 7~10Years For Normal Environment) 118g			
LENGTH	STANDARD 60cm	EUR TYPE 50cm	USA TYPE 30cm	
SPIKES FEATURES	QTY 48pcs	HEIGHT 110mm	PROTECT AREA 120mm	DIA 1.3mm
BASE FEATURES	BETWEEN PINS 3.6cm		THICKNESS 3.5mm	WIDTH 10/50mm
PACKING	Brown Carton <input type="checkbox"/>	With Box+Sticker <input type="checkbox"/>	Gift Box <input type="checkbox"/>	Head Card <input type="checkbox"/>
STANDARD PACKING	100Pcs/Ctn,Measure: 65X46X62cm G.W/N.W:12.8/11.8kgs			
AMAZON PACK				



NAME	Australia Z Type Bird Spikes		ITEM NO.:	HC1112-V2
MATERIAL	Polycarbonate(UV)+SUS304 (Quality Promise: 3~5 Years For Normal Environment) 95g			
LENGTH	STANDARD 50cm			
SPIKES FEATURES	QTY 40pcs	HEIGHT117mm	PROTECT AREA 123mm	DIA 1.3mm
BASE FEATURES	BETWEEN PINS 2.5cm		THICKNESS 6.6mm	WIDTH 62mm
PACKING	Brown Carton <input type="checkbox"/>	With Box+Sticker <input type="checkbox"/>	Gift Box <input type="checkbox"/>	Head Card <input type="checkbox"/>
STANDARD PACKING	100pcs/CTN, Measure: 55x40x40cm, G.W/N.W:10.5/9.5kgs			



NAME	America Standard Type Bird Spikes		ITEM NO.:	HC1108-W5
MATERIAL	Polycarbonate(UV)+SUS304 (Quality Promise: 7~10Years For Normal Environment) 158g			
LENGTH	STANDARD 60cm	EUR TYPE 50cm	USA TYPE 30cm	
SPIKES FEATURES	QTY 80pcs	HEIGHT 110mm	PROTECT AREA 180mm	DIA 1.3mm
BASE FEATURES	BETWEEN PINS 3.6cm		THICKNESS 3.5mm	WIDTH 10/50mm
PACKING	Brown Carton <input type="checkbox"/>	With Box+Sticker <input type="checkbox"/>	Gift Box <input type="checkbox"/>	Head Card <input type="checkbox"/>
STANDARD PACKING	100Pcs/Ctn, Measure:65x46x62cm G.W/N.W:16.8/15.8kgs			
AMAZON PACK				



NAME	Australia H Type Bird Spikes		ITEM NO.:	HC1111-H2
MATERIAL	Polycarbonate(UV)+SUS304 (Quality Promise: 3~5 Years For Normal Environment) 78g			
LENGTH	STANDARD 50cm			
SPIKES FEATURES	QTY 24pcs	HEIGHT 133mm	PROTECT AREA 160mm	DIA 1.3mm
BASE FEATURES	BETWEEN PINS 2.7cm		THICKNESS 4.9mm	WIDTH 62mm
PACKING	Brown Carton <input type="checkbox"/>	With Box+Sticker <input type="checkbox"/>	Gift Box <input type="checkbox"/>	Head Card <input type="checkbox"/>
STANDARD PACKING	100pcs/CTN, Measure: 55x40x40cm, G.W/N.W:8.8/7.8kgs			



NAME	Australia Standard Type Bird Spikes		ITEM NO.:	HC1104-U2
MATERIAL	Polycarbonate(UV)+SUS304 (Quality Promise: 3~5Years For Normal Environment) 57g			
LENGTH	STANDARD 50cm	USA TYPE 60cm	USA TYPE 30cm	DIY TYPE25cm
SPIKES FEATURES	QTY 20pcs	HEIGHT 110mm	PROTECT AREA 140mm	DIA 1.3mm
BASE FEATURES	BETWEEN PINS 5.0cm		THICKNESS 1.84mm	WIDTH 11/40.5mm
PACKING	Brown Carton <input type="checkbox"/>	With Box+Sticker <input type="checkbox"/>	Gift Box <input type="checkbox"/>	Head Card <input type="checkbox"/>
STANDARD PACKING	120Pcs/Ctn, Measure: 55x40x50cm, G.W/N.W:7.9/6.9kgs			
AMAZON PACK	10Pcs/Post Box			



NAME	Whole Plastic Bird Spikes		ITEM NO.:	HC1116-T3
MATERIAL	Whole Polycarbonate(UV) (Quality Promise: 7~10Years For Normal Environment) 42g			
LENGTH	STANDARD 50cm			
SPIKES FEATURES	QTY 14pcs	HEIGHT 120mm	PROTECT AREA 60mm	DIA2.3/ 7.9mm
BASE FEATURES	BETWEEN PINS 1.5/2.5cm		THICKNESS 4.3mm	WIDTH 20mm
PACKING	Brown Carton <input type="checkbox"/>	With Box+Sticker <input type="checkbox"/>	Gift Box <input type="checkbox"/>	Head Card <input type="checkbox"/>
STANDARD PACKING	120Pcs/Ctn, Measure:55x34x30cm G.W/N.W:6.1/5.1kgs			
AMAZON 10 FT PACK	10Pcs/Post Box			



NAME	Australia Standard Type Bird Spikes		ITEM NO.:	HC1104-U2S
MATERIAL	Polycarbonate(UV)+SUS304 (Quality Promise: 3~5Years For Normal Environment) 81g			
LENGTH	STANDARD 50cm	USA TYPE 60cm	USA TYPE 30cm	DIY TYPE25cm
SPIKES FEATURES	QTY 40pcs	HEIGHT 110mm	PROTECT AREA 150mm	DIA 1.3mm
BASE FEATURES	BETWEEN PINS 2.5cm		THICKNESS 1.84mm	WIDTH 11/40.5mm
PACKING	Brown Carton <input type="checkbox"/>	With Box+Sticker <input type="checkbox"/>	Gift Box <input type="checkbox"/>	Head Card <input type="checkbox"/>
STANDARD PACKING	120Pcs/Ctn, Measure: 55x40x50cm, G.W/N.W:10.8/9.8kgs			
AMAZON PACK	10Pcs/Post Box			







NAME	Australia Standard Type Bird Spikes		ITEM NO.:	HC1104-R2
MATERIAL	Polycarbonate(UV)+SUS304 (Quality Promise: 3~5Years For Normal Environment) 81g			
LENGTH	STANDARD 50cm	USA TYPE 60cm	USA TYPE 30cm	DIY TYPE25cm
SPIKES FEATURES	QTY 40pcs	HEIGHT 110mm	PROTECT AREA 140mm	DIA 1.3mm
BASE FEATURES	BETWEEN PINS 2.5cm		THICKNESS 1.84mm	WIDTH 11/40.5mm
PACKING	Brown Carton <input type="checkbox"/>	With Box+Sticker <input type="checkbox"/>	Gift Box <input type="checkbox"/>	Head Card <input type="checkbox"/>
STANDARD PACKING	120Pcs/Ctn, Measure: 55x40x50cm, G.W/N.W:10.8/9.8kgs			
AMAZON PACK	10Pcs/Post Box, 16Boxes/Ctn, Measure:66x39x45cm G.W/N.W:15/14kgs			



NAME	ECO Whole Stainless Steel Bird Spikes		ITEM NO.:	HC1106-U2
MATERIAL	Whole SUS304 (Quality Promise: 10~15Years For Normal Environment) 65g			
LENGTH	STANDARD 50cm	USA TYPE 60cm	USA TYPE 30cm	
SPIKES FEATURES	QTY 24pcs	HEIGHT 110mm	PROTECT AREA 100mm	DIA 1.3mm
BASE FEATURES	BETWEEN PINS 3.8cm		THICKNESS 2.1mm	WIDTH 26mm
PACKING	Brown Carton <input type="checkbox"/>	With Box+Sticker <input type="checkbox"/>	Gift Box <input type="checkbox"/>	Head Card <input type="checkbox"/>
STANDARD PACKING	100Pcs/Ctn, Measure: 56x42x53cm, G.W/N.W:7.5/6.5kgs			



NAME	Australia Standard Type Bird Spikes		ITEM NO.:	HC1104-W3
MATERIAL	Polycarbonate(UV)+SUS304 (Quality Promise: 3~5Years For Normal Environment) 68g			
LENGTH	STANDARD 50cm	USA TYPE 60cm	USA TYPE 30cm	DIY TYPE25cm
SPIKES FEATURES	QTY 30pcs	HEIGHT 110mm	PROTECT AREA 140mm	DIA 1.3mm
BASE FEATURES	BETWEEN PINS 2.5cm		THICKNESS 1.84mm	WIDTH 11/40.5mm
PACKING	Brown Carton <input type="checkbox"/>	With Box+Sticker <input type="checkbox"/>	Gift Box <input type="checkbox"/>	Head Card <input type="checkbox"/>
STANDARD PACKING	120Pcs/Ctn, Measure: 55x40x55cm, G.W/N.W:9.2/8.2kgs			
AMAZON PACK	10Pcs/Post Box, 12Boxes/Ctn, Box Size:33x15.5x13.5cm, Measure:49x36.5x57cm G.W/N.W:6.5/5.5kgs			



NAME	ECO Whole Stainless Steel Bird Spikes		ITEM NO.:	HC1106-V2
MATERIAL	Whole SUS304 (Quality Promise: 10~15Years For Normal Environment) 65g			
LENGTH	STANDARD 50cm	EUR TYPE 100cm	USA TYPE 30cm	
SPIKES FEATURES	QTY 24 pcs	HEIGHT 110mm	PROTECT AREA100mm	DIA 1.3mm
BASE FEATURES	BETWEEN PINS 3.8cm		THICKNESS 0.5mm	WIDTH 26mm
PACKING	Brown Carton <input type="checkbox"/>	With Box+Sticker <input type="checkbox"/>	Gift Box <input type="checkbox"/>	Head Card <input type="checkbox"/>
STANDARD PACKING	100 Pcs/Ctn, Measure: 56x42x53cm, G.W/N.W:7.5/6.5kgs			
AMAZON 10 FT PACK	10pcs/Post Box			



NAME	Australia Standard Type Bird Spikes		ITEM NO.:	HC1104-W4
MATERIAL	Polycarbonate(UV)+SUS304 (Quality Promise: 3~5Years For Normal Environment) 81g			
LENGTH	STANDARD 50cm	USA TYPE 60cm	USA TYPE 30cm	DIY TYPE25cm
SPIKES FEATURES	QTY 40pcs	HEIGHT 110mm	PROTECT AREA 40mm	DIA 1.3mm
BASE FEATURES	BETWEEN PINS 2.5cm		THICKNESS 1.84mm	WIDTH 11/40.5mm
PACKING	Brown Carton <input type="checkbox"/>	With Box+Sticker <input type="checkbox"/>	Gift Box <input type="checkbox"/>	Head Card <input type="checkbox"/>
STANDARD PACKING	120Pcs/Ctn, Measure: 55x40x55cm, G.W/N.W:10.8/9.8kgs			
AMAZON PACK	10Pcs/Post Box, 16Boxes/Ctn, Measure66x39x45cm G.W/N.W:15/14kgs			



NAME	ECO Whole Stainless Steel Bird Spikes		ITEM NO.:	HC1106-W3
MATERIAL	Whole SUS304 (Quality Promise: 10~15Years For Normal Environment) 81g			
LENGTH	STANDARD 50cm	EUR TYPE 100cm	USA TYPE 30cm	DIY TYPE25cm
SPIKES FEATURES	QTY 36pcs	HEIGHT 110mm	PROTECT AREA 140mm	DIA 1.3mm
BASE FEATURES	BETWEEN PINS 3.8cm		THICKNESS 0.5mm	WIDTH 26mm
PACKING	Brown Carton <input type="checkbox"/>	With Box+Sticker <input type="checkbox"/>	Gift Box <input type="checkbox"/>	Head Card <input type="checkbox"/>
STANDARD PACKING	100Pcs/Ctn, Measure: 55x41x52cm, G.W/N.W:9.1/8.1kgs			
AMAZON 10 FT PACK	10Pcs/Post Box,12Boxes/Ctn, Box Size:15.5x13.5x36.5cm,Measure: 56x48x38cm,G.W/N.W:7.5/6.5kgs			



NAME	Australia Standard Type Bird Spikes		ITEM NO.:	HC1104-W4S
MATERIAL	Polycarbonate(UV)+SUS304 (Quality Promise: 3~5Years For Normal Environment) 81g			
LENGTH	STANDARD 50cm	USA TYPE 60cm	USA TYPE 30cm	DIY TYPE25cm
SPIKES FEATURES	QTY 40pcs	HEIGHT 110mm	PROTECT AREA 140mm	DIA 1.3mm
BASE FEATURES	BETWEEN PINS 2.5cm		THICKNESS 1.84mm	WIDTH 11/40.5mm
PACKING	Brown Carton <input type="checkbox"/>	With Box+Sticker <input type="checkbox"/>	Gift Box <input type="checkbox"/>	Head Card <input type="checkbox"/>
STANDARD PACKING	120Pcs/Ctn, Measure: 55x40x55cm, G.W/N.W:10.8/9.8kgs			
AMAZON PACK	10Pcs/Post Box			



NAME	ECO Whole Stainless Steel Bird Spikes		ITEM NO.:	HC1106-W4
MATERIAL	Whole SUS304 (Quality Promise: 10~15 Years For Normal Environment) 95g			
LENGTH	STANDARD 50cm	EUR TYPE 100cm	USA TYPE 30cm	
SPIKES FEATURES	QTY 40pcs	HEIGHT 110mm	PROTECT AREA 160mm	DIA 1.3mm
BASE FEATURES	BETWEEN PINS 3.8cm		THICKNESS 0.5mm	WIDTH 26mm
PACKING	Brown Carton <input type="checkbox"/>	With Box+Sticker <input type="checkbox"/>	Gift Box <input type="checkbox"/>	Head Card <input type="checkbox"/>
STANDARD PACKING	100 pcs/Ctn, Measure: 55x41x52cm, G.W/N.W:10.5/9.5kgs			
AMAZON 10 FT PACK	10pcs/Post Box			





NAME	Australia Standard Type Bird Spikes		ITEM NO.:	HC1104-W5
MATERIAL	Polycarbonate(UV)+SUS304 (Quality Promise: 3~5 Years For Normal Environment) 92g			
LENGTH	STANDARD 50cm	USA TYPE 60cm	USA TYPE 30cm	DIY TYPE25cm
SPIKES FEATURES	QTY 50pcs	HEIGHT 110mm	PROTECT AREA 150mm	DIA 1.3mm
BASE FEATURES	BETWEEN PINS 2.5cm		THICKNESS 1.84mm	WIDTH 11/40.5mm
PACKING	Brown Carton <input type="checkbox"/>	With Box+Sticker <input type="checkbox"/>	Gift Box <input type="checkbox"/>	Head Card <input type="checkbox"/>
STANDARD PACKING	120Pcs/Ctn, Measure: 55x50x40cm, G.W/N.W:12/11kg			
AMAZON 10 FT PACK	10Pcs/Post Box,12Boxes/Ctn, Box Size:25.5x13.5x33cm,Measure:79x36x57cm G.W/N.W:8.5/7.5kg			



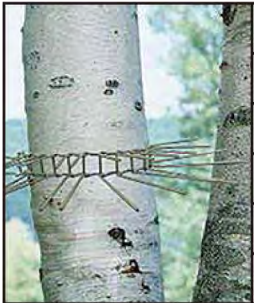

NAME	ECO Whole Stainless Steel Bird Spikes		ITEM NO.:	HC1106-W5
MATERIAL	Whole SUS304 (Quality Promise: 10~15Years For Normal Environment) 95g			
LENGTH	STANDARD 50cm	EUR TYPE 100cm	USA TYPE 30cm	
SPIKES FEATURES	QTY 40pcs	HEIGHT 110mm	PROTECT AREA 170mm	DIA 1.3mm
BASE FEATURES	BETWEEN PINS 2.3cm		THICKNESS 0.5mm	WIDTH 26mm
PACKING	Brown Carton <input type="checkbox"/>	With Box+Sticker <input type="checkbox"/>	Gift Box <input type="checkbox"/>	Head Card <input type="checkbox"/>
STANDARD PACKING	100 Pcs/Ctn, Measure: 55x48x52cm, G.W/N.W:10.5/9.5kgs			
AMAZON 10 FT PACK	10Pcs/Post Box			



	NAME	Step Proof Cat/Wild Animal Spikes	ITEM NO.:	HC1121-H		
	MATERIAL	Steel		400g/bag		
	SPIKES FEATURES	Qty: 40pcs	Hight: 110mm	Protect Area: 150mm	Dia: 2mm	
	PACKING	Bulk Pack <input type="checkbox"/>	White Box+Sticker <input type="checkbox"/>	Gift Box <input type="checkbox"/>	Head Card <input type="checkbox"/>	Blister Card <input type="checkbox"/>
	STANDARD PACKING	20 Pcs/Bag,10Bags/Ctn, Measure: 32X28.5X13cm, G.W/N.W:4.7/4kgs				
	AMAZON PACK	20 Pcs/Bag,10Bags/Ctn, Measure: 32X28.5X13cm, G.W/N.W:4.7/4kgs				

	NAME	Step Proof Cat/Wild Animal Spikes	ITEM NO.:	HC1117-W2
	MATERIAL	PP		60g
	COLOUR	Brown,Faint Yellow,Milk White,Green,Black,White and etc		
	SIZE	48.7x4.2x1.5cm		
	STANDARD PACKING	10Pcs/Box, 12 Boxes/Ctn Box Measure: 50x6.6x5cm, Ctn Measure:54.7x15.8x34cm G.W/N.W:8.68/7.68kg		
	AMAZON PACKING	10Pcs/Box, 12 Boxes/Ctn Box Measure: 50x6.6x5cm,Ctn Measure:54.7x15.8x34cm G.W/N.W:8.68/7.68kg		

	NAME	Step Proof Cat/Wild Animal Spikes	ITEM NO.:	HC1117-V3
	MATERIAL	PP		120g
	COLOUR	Brown,Faint Yellow,Milk White,Green,Black,White and etc		
	SIZE	50x10x2.8cm		
	STANDARD PACKING	4Pcs/box, 12 boxes/Ctn Box Measure: 50.5x10.5x6.3cm, Ctn Measure:54.7x15.8x 34 G.W/N.W:7.96/6.96kg		
	AMAZON PACKING			

	NAME	Step Proof Cat/Wild Animal Spikes	ITEM NO.:	HC1119-T3		
	MATERIAL	PVC		114g		
	SIZE	44x6.6x10.7cm				
	SPIKES FEATURES	QTY 40pcs	Hight: 110mm	Protect Area:150mm	Dia: 2mm	
	PACKING	Brown Carton <input type="checkbox"/>	With Box+Sticker <input type="checkbox"/>	Gift Box <input type="checkbox"/>	Head Card <input type="checkbox"/>	Blister Card <input type="checkbox"/>
	STANDARD PACKING	2pcs/Card, 48pcs/CTN, Measure: 46x41x47cm G.W/N.W:7.6/5.7KGS				
AMAZON PACK	2pcs/Card, 12cards/CTN					

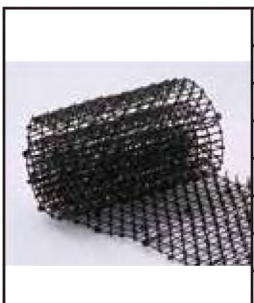
	NAME	Step Proof Cat/Wild Animal Spikes	ITEM NO.:	HC1120-T		
	MATERIAL	PP		70g		
	SIZE	48.5X13.5X27CM				
	LENGTH	48.5CM				
	PACKING	Brown Carton <input type="checkbox"/>	With Box+Sticker <input type="checkbox"/>	Gift Box <input type="checkbox"/>	Head Card <input type="checkbox"/>	Blister Card <input type="checkbox"/>
	STANDARD PACKING	2PCS/Sleeve Pack, 80pcs/CTN, Measure: 56x51x31cm, G.W/N.W:6.2/5.6KGS				
AMAZON PACK	2PCS/Sleeve Pack, 80pcs/CTN, Measure: 56x51x31cm, G.W/N.W:6.2/5.6KGS					

Spider Seagull Repeller

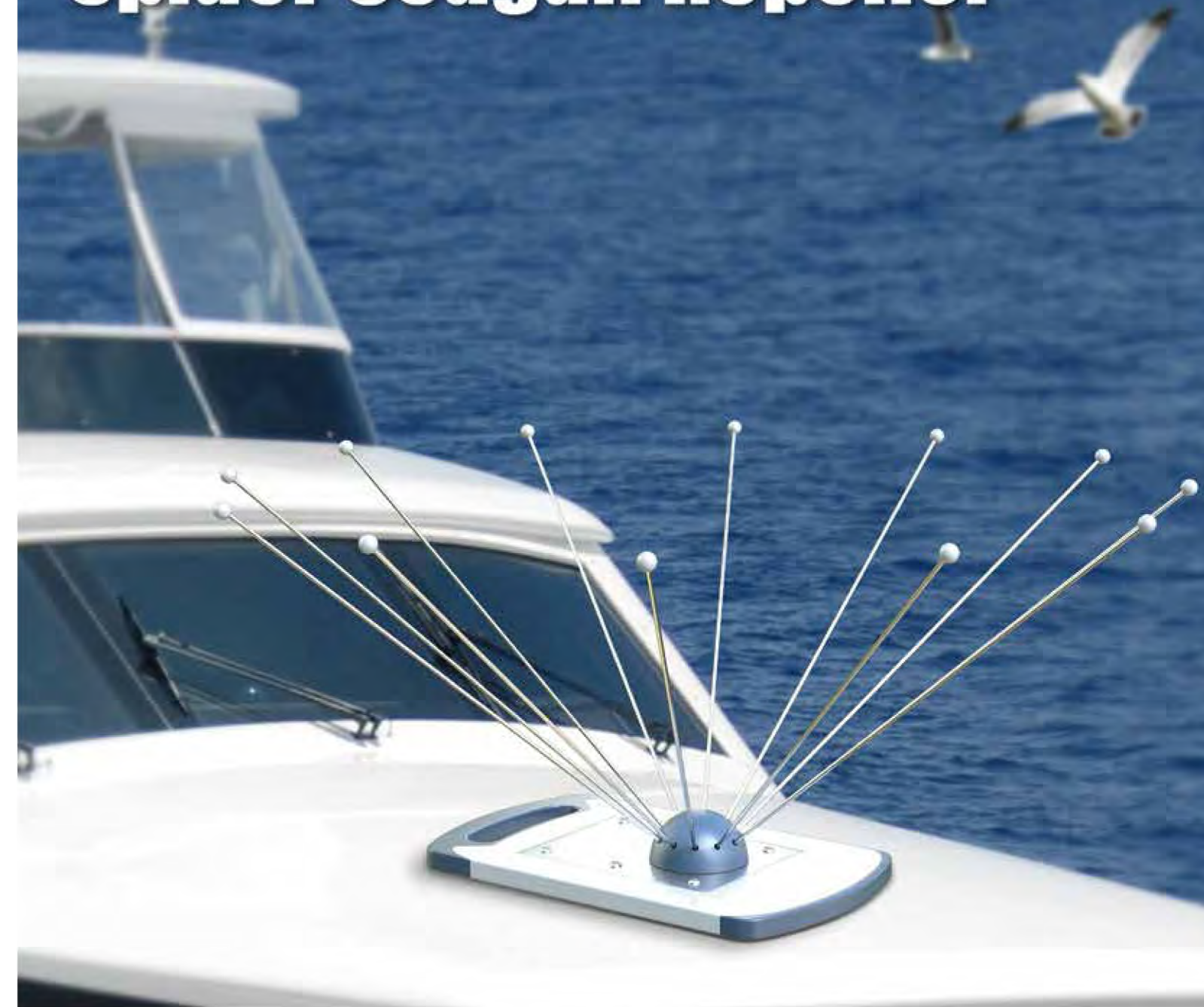

Item NO.	Protect Area Dia For Chose	Packing	Measure	MOQ	Delivery
HC1115-T12	60cm <input type="checkbox"/> 80cm <input type="checkbox"/> 120cm <input type="checkbox"/> 180cm <input type="checkbox"/> 260cm <input type="checkbox"/>	1Pcs/Box	As Per Length	500pcs	50 Days
HC1115-T12B	260x130x9mm	100Pcs/Ctn		500pcs	50 Days



Bird Control

Best Seller Bird Spikes Packing List For Choose

			
HC11001	HC11002	E6000B	S601, S616
			
HC1618 M4, M5, M6, M8	HC1614 Screw Eye Bolt	HC1617 M6, M8	HC1620
			
HC1619 Ferrule Tongs	HC1610 (P7 Rings)	HC1612 (P7) HANDS TOOLS	HC1208 BIRD Wire Spring
			
HC1210 BIRD WIRE	HC1513 Ferrule	HC1611 BIRD NET WIRE	HC1209 BIRD WIRE LOCK
			
HC1615	HC1213	HC11002C	HC1616
			
HC1211	HC1214	HC1215	HC1216



Netting Fruit Protective Net



Bird Control

	NAME	Nylon Bird Proof Netting		ITEM NO.:	HC130903	
	MATERIAL	Nylon	WIRE DIA	0.3mm	COLOUR	Transparent
	MESH SIZE	2.5cm	CUT SHAPE	Diamond		
	ROPE TYPE	Single Wire	KNOT TYPE	Knotted		
	NET SIZE	2x10m, 3x10m, 4X10M, 4.8x10m, 10x10m, 10x20m, 10x50m, 10x100m				
	PACKING	Bulk Pack <input type="checkbox"/>	White Box+Sticker <input type="checkbox"/>	Gift Box <input type="checkbox"/>	Head Card <input type="checkbox"/>	
	STANDARD PACKING	1Pc/Box, 12Boxes/Ctn, Measure: 60.3x30.5x37cm, G.W/N.W: 13.5/12.5kgs				
	USE FOR	Farm, Fruit Trees Or Similar Area				

	NAME	Nylon Bird Proof Netting		ITEM NO.:	HC130904	
	MATERIAL	Nylon	WIRE DIA	0.4mm	COLOUR	Transparent
	MESH SIZE	3.5cm	CUT SHAPE	Diamond		
	ROPE TYPE	Single Wire	KNOT TYPE	Knotted		
	NET SIZE	2x10m, 3x3m, 4x4m, 5x5m, 3x10m, 4X10M, 4.8x10m, 10x10m, 10x20m				
	PACKING	Bulk Pack <input type="checkbox"/>	White Box+Sticker <input type="checkbox"/>	Gift Box <input type="checkbox"/>	Head Card <input type="checkbox"/>	
	STANDARD PACKING	1Pc/Box, 12Boxes/Ctn, Measure: 60.3x30.5x37cm, G.W/N.W: 12.12/11.12kgs				
	USE FOR	Farm, Fruit Trees Or Similar Area				

	NAME	Nylon Bird Proof Netting		ITEM NO.:	HC130906	
	MATERIAL	Nylon	WIRE DIA	0.6mm	COLOUR	Transparent
	MESH SIZE	3.0cm	CUT SHAPE	Diamond		
	ROPE TYPE	Single Wire	KNOT TYPE	Knotted		
	NET SIZE	2x10m, 3x10m, 4X10m, 4.8x10m, 10x10m, 10x20m, 10x50m, 10x100m				
	PACKING	Bulk Pack <input type="checkbox"/>	White Box+Sticker <input type="checkbox"/>	Gift Box <input type="checkbox"/>	Head Card <input type="checkbox"/>	
	STANDARD PACKING	1Pc/Box, 12Boxes/Ctn, Measure: 60.3x30.5x37cm, G.W/N.W: 13/12kgs				
	USE FOR	Farm, Fruit Trees Or Similar Area				

	NAME	Nylon Bird Proof Netting		ITEM NO.:	HC130906S	
	MATERIAL	Nylon	WIRE DIA	0.6mm	COLOUR	Transparent
	MESH SIZE	5.0cm	CUT SHAPE	Diamond		
	ROPE TYPE	Single Wire	KNOT TYPE	Knotted		
	NET SIZE	2x10m, 3x10m, 4X10m, 4.8x10m, 10x10m, 10x20m, 10x50m, 10x100m				
	PACKING	Bulk Pack <input type="checkbox"/>	White Box+Sticker <input type="checkbox"/>	Gift Box <input type="checkbox"/>	Head Card <input type="checkbox"/>	
	STANDARD PACKING	1Pc/Box, 12Boxes/Ctn, Measure: 60.3x30.5x37cm, G.W/N.W: 11/10kgs				
	USE FOR	Farm, Fruit Trees Or Similar Area				

	NAME	Bird Netting Install	ITEM NO.:	HC130900S	
	USE FOR	Install bird netting			



	NAME	Bird Proof Netting		ITEM NO.:	HC1308N50	
	MATERIAL	Polyester	WIRE DIA	1mm	COLOUR	Black
	MESH SIZE	50mm (2")	CUT SHAPE	Diamond	GRAMMAGE	8G/M2
	ROPE TYPE	210D*3ply	KNOT TYPE	Knoted		
	NET SIZE	25x50ft (7.5x15m), 50x50ft (15x15m), 50x100ft (15x30m), 100x100ft (30x30m)				
	PACKING	Bulk Pack <input type="checkbox"/>	White Box+Sticker <input type="checkbox"/>	Gift Box <input type="checkbox"/>	Head Card <input type="checkbox"/>	
	STANDARD PACKING	25x50ft: 1Pc/Box, Size: 14x24x12cm, 24Boxes/Ctn Size: 50x40x50cm, G.W: 20.5kgs				
	USE FOR	Farm, Fruit Trees Or Similar Area				

	NAME	Bird Proof Netting		ITEM NO.:	HC1308N25	
	MATERIAL	Polyester	WIRE DIA	1mm	COLOUR	Black
	MESH SIZE	25mm (1")	CUT SHAPE	Diamond	GRAMMAGE	20G/M2
	ROPE TYPE	210D*3ply	KNOT TYPE	Knoted		
	NET SIZE	25x50ft (7.5x15m), 50x50ft (15x15m), 50x100ft (15x30m), 100x100ft (30x30m)				
	PACKING	Bulk Pack <input type="checkbox"/>	White Box+Sticker <input type="checkbox"/>	Gift Box <input type="checkbox"/>	Head Card <input type="checkbox"/>	
	STANDARD PACKING	25x50ft: 1Pc/Box, Size: 14x24x12cm, 8Boxes/Ctn Size: 50x40x50cm, G.W: 22.5kg				
	USE FOR	Farm, Fruit Trees Or Similar Area				

	NAME	ECO Bird Proof Netting		ITEM NO.:	HC1306	
	MATERIAL	HDPE				
	MESH SIZE	2cm (3/4")	CUT SHAPE	Diamond	GRAMMAGE	22G/M2
	ROPE TYPE	Single Wire	KNOT TYPE	Knoted		
	COLOUR	Black <input type="checkbox"/>	White <input type="checkbox"/>	Green <input type="checkbox"/>	Dark Green <input type="checkbox"/>	
	NET SIZE	2x10m, 3x10m, 4x10m, 4.8x10m, 10x10m, 10x20m, 10x50m, 10x100m				
	PACKING	Bulk Pack <input type="checkbox"/>	White Box+Sticker <input type="checkbox"/>	Gift Box <input type="checkbox"/>	Head Card <input type="checkbox"/>	
	STANDARD PACKING	1Pc/Box, 12Boxes/Ctn, Measure: 60.3x30.5x37cm, G.W/N.W: 13/12kgs				
	USE FOR	Farm, Fruit Trees Or Similar Area				

	NAME	Premium Grade Bird Proof Netting		ITEM NO.:	HC15042-P	
	MATERIAL	PP <input type="checkbox"/>	PP+UV <input type="checkbox"/>	PE <input type="checkbox"/>	PP+UVR <input type="checkbox"/>	
	MESH SIZE	12mm (1/2")	CUT SHAPE	Diamond	GRAMMAGE	30G/M2
	COLOUR	Black <input type="checkbox"/>	White <input type="checkbox"/>	Green <input type="checkbox"/>	Dark Green <input type="checkbox"/>	
	NET SIZE	7x20ft, 7x30ft, 7x60ft, 7.5x65ft, 7x100ft, 14x14ft, 14x30ft, 14x50ft, 14x100ft				
	PACKING	Bulk Pack <input type="checkbox"/>	White Box+Sticker <input type="checkbox"/>	Gift Box <input type="checkbox"/>	Head Card <input type="checkbox"/>	
	STANDARD					
	USE FOR	Farm, Fruit Trees Or Similar Area				

	NAME	Light Weight Grade BIRD NETTING		ITEM NO.:	HC15042-L	
	MATERIAL	PP <input type="checkbox"/>	PP+UV <input type="checkbox"/>	PE <input type="checkbox"/>	PP+UVR <input type="checkbox"/>	
	MESH SIZE	15mm (5/8")	CUT SHAPE	Diamond	GRAMMAGE	8G/M2
	COLOUR	Black <input type="checkbox"/>	White <input type="checkbox"/>	Green <input type="checkbox"/>	Dark Green <input type="checkbox"/>	
	NET SIZE	7x20ft, 7x30ft, 7x60ft, 7.5x65ft, 7x100ft, 14x14ft, 14x30ft, 14x50ft, 14x100ft				
	PACKING	Bulk Pack <input type="checkbox"/>	White Box+Sticker <input type="checkbox"/>	Gift Box <input type="checkbox"/>	Head Card <input type="checkbox"/>	
	STANDARD					
	USE FOR	Farm, Fruit Trees Or Similar Area				

	NAME	Bird Proof Netting		ITEM NO.:	HC13077	
	MATERIAL	Polyethylene				
	MESH SIZE	7x7mm	CUT SHAPE	Diamond		
	ROPE TYPE	Single Rope	KNOT TYPE	Extrude Netting		
	COLOUR	Black <input type="checkbox"/>	White <input type="checkbox"/>	Green <input type="checkbox"/>	Dark Green <input type="checkbox"/>	
	NET SIZE	2x10m, 4x5m, 4x10m, 4x12m, 6.5x33ft, 13x33ft, 6.5x50ft				
	PACKING	Bulk Pack <input type="checkbox"/>	White Box+Sticker <input type="checkbox"/>	Gift Box <input type="checkbox"/>	Head Card <input type="checkbox"/>	
	STANDARD	2X10m: 80Pcs/Ctn, Measure: 42x42x27cm, G.W/N.W: 12.5/11.5kgs 4X10m: 45Pcs/Ctn, Measure: 42x42x32cm, G.W/N.W: 14.5/12.8kgs 4x12m: 30Pcs/Ctn, Measure: 56X38X32cm, G.W/N.W: 11.5/10.8kgs				
	USE FOR	Farm, Fruit Trees Or Similar Area				

	NAME	Bird Proof Netting		ITEM NO.:	HC130710	
	MATERIAL	Polyethylene				
	MESH SIZE	10x10mm	CUT SHAPE	Diamond		
	ROPE TYPE	Single Rope	KNOT TYPE	Extrude Netting		
	COLOUR	Black <input type="checkbox"/>	White <input type="checkbox"/>	Green <input type="checkbox"/>	Dark Green <input type="checkbox"/>	
	NET SIZE	2x10m, 4x5m, 4x10m, 4x12m, 6.5x33ft, 13x33ft, 6.5x50ft				
	PACKING	Bulk Pack <input type="checkbox"/>	White Box+Sticker <input type="checkbox"/>	Gift Box <input type="checkbox"/>	Head Card <input type="checkbox"/>	
	STANDARD	2X10m: 80Pcs/Ctn, Measure: 42x42x27cm, G.W/N.W: 12.5/11.5kgs 4X10m: 45Pcs/Ctn, Measure: 42x42x32cm, G.W/N.W: 14.5/12.8kgs 4x12m: 30Pcs/Ctn, Measure: 56X38X32cm, G.W/N.W: 11.5/10.8kgs				
	USE FOR	Farm, Fruit Trees Or Similar Area				

	NAME	Bird Proof Netting		ITEM NO.:	HC130712	
	MATERIAL	Polyethylene				
	MESH SIZE	12x12 mm	CUT SHAPE	Diamond		
	ROPE TYPE	Single Rope	KNOT TYPE	Extrude Netting		
	COLOUR	Black <input type="checkbox"/>	White <input type="checkbox"/>	Green <input type="checkbox"/>	Dark Green <input type="checkbox"/>	
	NET SIZE	2x10m, 4x5m, 4x10m, 4x12m, 6.5x33ft, 13x33ft, 6.5x50ft				
	PACKING	Bulk Pack <input type="checkbox"/>	White Box+Sticker <input type="checkbox"/>	Gift Box <input type="checkbox"/>	Head Card <input type="checkbox"/>	
	STANDARD	2X10m: 80Pcs/Ctn, Measure: 42x42x27cm, G.W/N.W: 12.5/11.5kgs 4X10m: 45Pcs/Ctn, Measure: 42x42x32cm, G.W/N.W: 14.5/12.8kgs 4x12m: 30Pcs/Ctn, Measure: 56X38X32cm, G.W/N.W: 11.5/10.8kgs				
	USE FOR	Farm, Fruit Trees Or Similar Area				

	NAME	Bird Proof Netting		ITEM NO.:	HC130720	
	MATERIAL	Polyethylene				
	MESH SIZE	20x20mm	CUT SHAPE	Diamond		
	ROPE TYPE	Single Rope	KNOT TYPE	Extrude Netting		
	COLOUR	Black <input type="checkbox"/>	White <input type="checkbox"/>	Green <input type="checkbox"/>	Dark Green <input type="checkbox"/>	
	NET SIZE	2x10m, 4x5m, 4x10m, 4x12m, 6.5x33ft, 13x33ft, 6.5x50ft				
	PACKING	Bulk Pack <input type="checkbox"/>	White Box+Sticker <input type="checkbox"/>	Gift Box <input type="checkbox"/>	Head Card <input type="checkbox"/>	
	STANDARD	2X10m: 80Pcs/Ctn, Measure: 42x42x27cm, G.W/N.W: 12.5/11.5kgs 4X10m: 45Pcs/Ctn, Measure: 42x42x32cm, G.W/N.W: 14.5/12.8kgs 4x12m: 30Pcs/Ctn, Measure: 56X38X32cm, G.W/N.W: 11.5/10.8kgs				
	USE FOR	Farm, Fruit Trees Or Similar Area				



Bird Control

	NAME	Bird Proof Netting		ITEM NO.:	HC1301N20	
	MATERIAL	Polyethylene	WIRE DIA	1mm		
	MESH SIZE	20x20mm	CUT SHAPE	Diamond	GRAMMAGE	60G/M2
	ROPE TYPE	210D*12Ply	KNOT TYPE	Konted		
	COLOUR	Black <input type="checkbox"/>	White <input type="checkbox"/>	Green <input type="checkbox"/>	Dark Green <input type="checkbox"/>	
	NET SIZE	25x50ft (7.5x15m), 50x50ft (15x15m), 50x100ft (15x30m), 100x100ft (30x30m)				
	PACKING	Bulk Pack <input type="checkbox"/>	White Box+Sticker <input type="checkbox"/>	Gift Box <input type="checkbox"/>	Head Card <input type="checkbox"/>	
	STANDARD	25x50ft: 1Pc/Box, 8Boxes/Ctn, Measure: 60x50x40cm, G.W: 25kgs 50x50ft: 1Pc/box, 4Boxes/Ctn, Measure: 60x50x40cm, G.W: 25kgs				
	USE FOR	Farm, Fruit Trees Or Similar Area				

	NAME	Bird Proof Netting		ITEM NO.:	HC1301N50	
	MATERIAL	Polyethylene	WIRE DIA	1mm		
	MESH SIZE	50x50mm	CUT SHAPE	Diamond	GRAMMAGE	21G/M2
	ROPE TYPE	210D*12Ply	KNOT TYPE	Konted		
	COLOUR	Black <input type="checkbox"/>	White <input type="checkbox"/>	Green <input type="checkbox"/>	Dark Green <input type="checkbox"/>	
	NET SIZE	25x50ft (7.5x15m), 50x50ft (15x15m), 50x100ft (15x30m), 100x100ft (30x30m)				
	PACKING	Bulk Pack <input type="checkbox"/>	White Box+Sticker <input type="checkbox"/>	Gift Box <input type="checkbox"/>	Head Card <input type="checkbox"/>	
	STANDARD	25x50ft: 1Pc/Box, 24Boxes/Ctn, Measure: 60x50x40cm, G.W: 25kgs 50x50ft: 1Pc/Box, 12Boxes/Ctn, Measure: 60x50x40cm, G.W: 25kgs				
	USE FOR	Farm, Fruit Trees Or Similar Area				

	NAME	Bird Proof Netting		ITEM NO.:	HC1303N19	
	MATERIAL	HDPE	WIRE DIA	2000D		
	MESH SIZE	19x19m	CUT SHAPE	Foursquare	GRAMMAGE	35G/M2
	ROPE TYPE	2000D*1Ply	KNOT TYPE	Konted		
	COLOUR	Black <input type="checkbox"/>	White <input type="checkbox"/>	Green <input type="checkbox"/>	Dark Green <input type="checkbox"/>	
	NET SIZE	2x10m, 3x10m, 4x5m, 4x10m, 4x12m, 6.5x33ft, 13x33ft, 6.5x50ft				
	PACKING	Bulk Pack <input type="checkbox"/>	White Box+Sticker <input type="checkbox"/>	Gift Box <input type="checkbox"/>	Head Card <input type="checkbox"/>	
	STANDARD					
	USE FOR	Farm, Fruit Trees Or Similar Area				

	NAME	Bird Proof Netting		ITEM NO.:	HC1303N50	
	MATERIAL	HDPE	WIRE DIA	2500D		
	MESH SIZE	50x50m	CUT SHAPE	Foursquare	GRAMMAGE	12G/M2
	ROPE TYPE	2500D*1Ply	KNOT TYPE	Konted		
	COLOUR	Black <input type="checkbox"/>	White <input type="checkbox"/>	Green <input type="checkbox"/>	Dark Green <input type="checkbox"/>	
	NET SIZE	2x10m, 3x10m, 4x5m, 4x10m, 4x12m, 6.5x33ft, 13x33ft, 6.5x50ft				
	PACKING	Bulk Pack <input type="checkbox"/>	White Box+Sticker <input type="checkbox"/>	Gift Box <input type="checkbox"/>	Head Card <input type="checkbox"/>	
	STANDARD					
	USE FOR	Farm, Fruit Trees Or Similar Area				

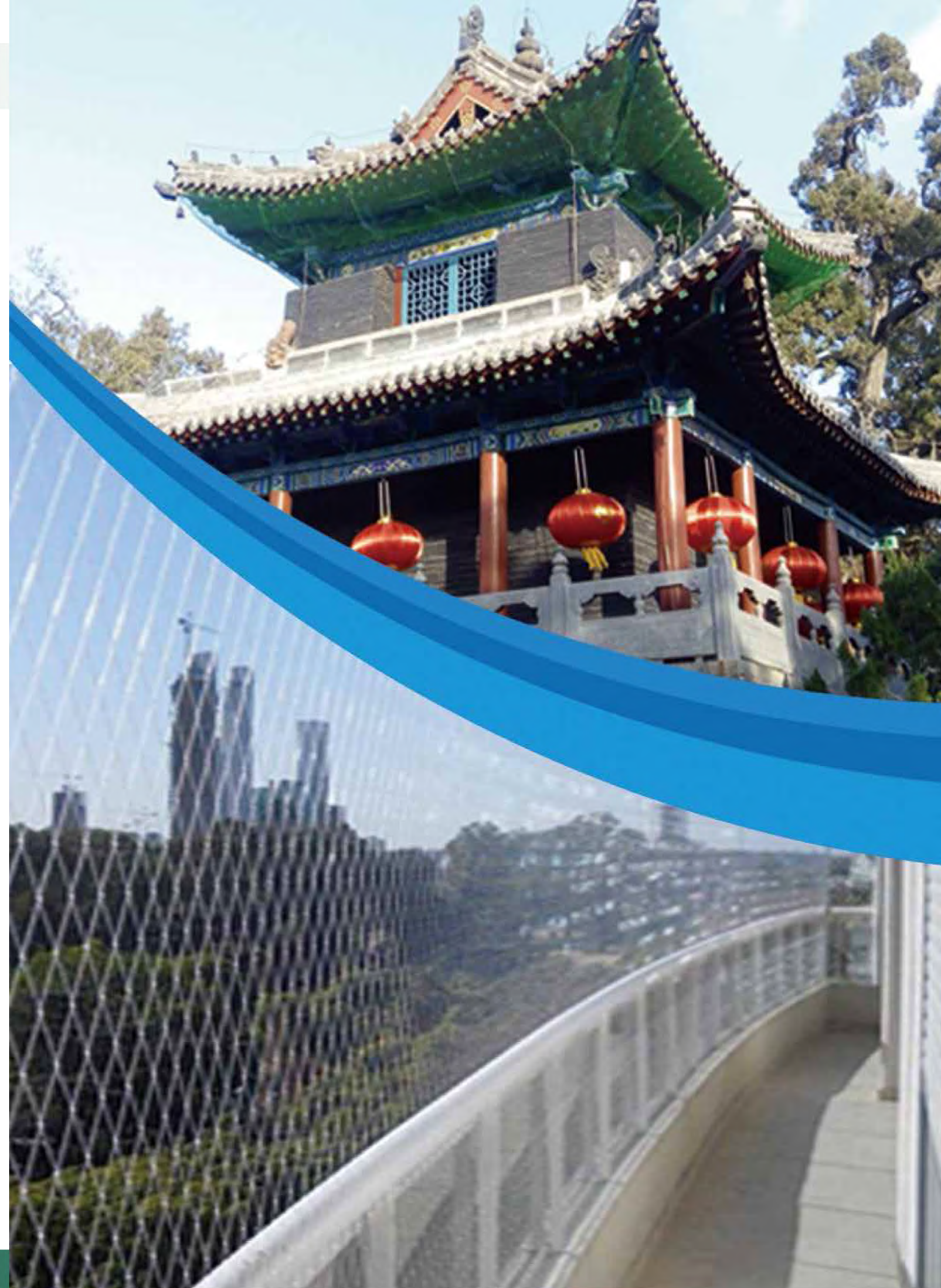





NAME	Bird Proof Netting		ITEM NO.:	HC130119	
MATERIAL	HDPE+UV	WIRE DIA	1.0mm		
MESH SIZE	19x19mm (3/4")	CUT SHAPE	Foursquare	GRAMMAGE	68G/M2
ROPE TYPE	210D*12Ply	KNOT TYPE	Konted		
COLOUR	Black <input type="checkbox"/>	White <input type="checkbox"/>	Green <input type="checkbox"/>	Stone Color <input type="checkbox"/>	
NET SIZE	25x50ft (7.5x15m), 50x50ft (15x15m), 50x100ft (15x30m), 100x100ft (30x30m)				
PACKING	Bulk Pack <input type="checkbox"/>	White Box+Sticker <input type="checkbox"/>	Gift Box <input type="checkbox"/>	Head Card <input type="checkbox"/>	
STANDARD					
USE FOR	Industrial				



NAME	Bird Proof Netting		ITEM NO.:	HC130150	
MATERIAL	HDPE+UV	WIRE DIA	1.0mm		
MESH SIZE	50x50mm (2")	CUT SHAPE	Foursquare	GRAMMAGE	28G/M2
ROPE TYPE	210D*12Ply	KNOT TYPE	Konted		
COLOUR	Black <input type="checkbox"/>	White <input type="checkbox"/>	Green <input type="checkbox"/>	Stone Color <input type="checkbox"/>	
NET SIZE	25x50ft (7.5x15m), 50x50ft (15x15m), 50x100ft (15x30m), 100x100ft (30x30m)				
PACKING	Bulk Pack <input type="checkbox"/>	White Box+Sticker <input type="checkbox"/>	Gift Box <input type="checkbox"/>	Head Card <input type="checkbox"/>	
STANDARD					
USE FOR	Industrial				



NAME	Bird Proof Netting		ITEM NO.:	HC130319	
MATERIAL	HDPE+UV	WIRE DIA	1.0mm		
MESH SIZE	19x19mm (3/4")	CUT SHAPE	Foursquare	GRAMMAGE	35G/M2
ROPE TYPE	2000D*1Ply	KNOT TYPE	Konted		
COLOUR	Black <input type="checkbox"/>	White <input type="checkbox"/>	Green <input type="checkbox"/>	Stone Color <input type="checkbox"/>	
NET SIZE	3x10m, 6x50m, 6x100m				
PACKING	Bulk Pack <input type="checkbox"/>	White Box+Sticker <input type="checkbox"/>	Gift Box <input type="checkbox"/>	Head Card <input type="checkbox"/>	
STANDARD	6x50m: 1Pcs/Ctn, Measure: 2.2x25x25cm, G.W/N.W: 11/10kgs				
USE FOR	Industrial				



NAME	Bird Proof Netting		ITEM NO.:	HC130350	
MATERIAL	HDPE+UV				
MESH SIZE	50x50mm (2")	CUT SHAPE	Foursquare	GRAMMAGE	12G/M2
ROPE TYPE	2500D*1Ply	KNOT TYPE	Konted		
COLOUR	Black <input type="checkbox"/>	White <input type="checkbox"/>	Green <input type="checkbox"/>	Stone Color <input type="checkbox"/>	
NET SIZE	3x10m, 6x50m, 6x100m				
PACKING	Bulk Pack <input type="checkbox"/>	White Box+Sticker <input type="checkbox"/>	Gift Box <input type="checkbox"/>	Head Card <input type="checkbox"/>	
STANDARD	6x50m: 1Pcs/Ctn, Measure: 2.2x25x25cm, G.W/N.W: 11/10kgs				
USE FOR	Industrial				





Problems caused by birds at the airport



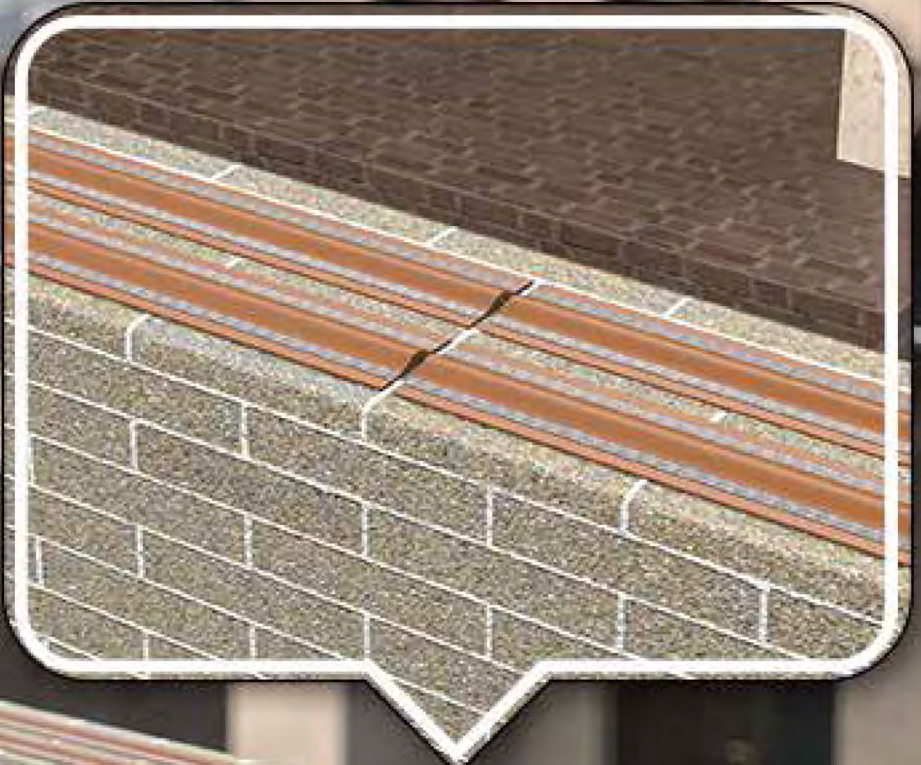

Accidents caused by birds at the airport

Bird Control



	NAME	Bird Control Shock Machine	ITEM NO.:	HC1650
	SIZE	18X11X45cm	WEIGHT	600g
	POWER	230 volts / 50 hz / 2 watts	VOLTAGE VACUM	5000volts
	CONSUMPTION	0.010 A / hour	EFFECTIVE DISTANCE	10km
	POWER OUT	500ohms 0.6joules	DELIVERED POWER	1.2joules
	EXTRA SERVICE	Design For Customer <input type="checkbox"/>	OEM/ODM <input type="checkbox"/>	Develop New Item <input type="checkbox"/>
	STANDARD PACK	30Pcs/Ctn, Measure: 46x37x30cm, G.W/N.W: 22/21kgs		
	USD FOR	Bird Repellent		

	NAME	Bird Control Shock Machine	ITEM NO.:	HC1651
	SIZE	22X10X27.5cm	WEIGHT	2.5kgs
	POWER	230 volts / 50 hz	VOLTAGE VACUM	12000volts
	CONSUMPTION	0.016A / hour	EFFECTIVE DISTANCE	40km
	POWER OUT	500ohms 2joules	DELIVERED POWER	5.5joules
	EXTRA SERVICE	Design For Customer <input type="checkbox"/>	OEM/ODM <input type="checkbox"/>	Develop New Item <input type="checkbox"/>
	STANDARD PACK	4Pcs/Ctn, Measure: 49x25x27cm, G.W/N.W: 12/11kgs		
	USD FOR	Bird Repellent		

	NAME	Bird Control Shock Machine	ITEM NO.:	HC1652
	SIZE	22X10X27.5cm	WEIGHT	2.5KGS
	POWER	230 volts / 50 hz / 2 watts	VOLTAGE VACUM	5000volts
	CONSUMPTION	0.047 A / hour	EFFECTIVE DISTANCE	10km
	POWER OUT	500ohms 4.1joules	DELIVERED POWER	120km
	EXTRA SERVICE	Design For Customer <input type="checkbox"/>	OEM/ODM <input type="checkbox"/>	Develop New Item <input type="checkbox"/>
	STANDARD PACK	4Pcs/Ctn, Measure: 49x25x27cm, G.W/N.W: 12/11kgs		
	USD FOR	Bird Repellent		

	NAME	Easy Bird Control Shock Machine	ITEM NO.:	HC1653
	SIZE	18X11X45cm	WEIGHT	600g
	POWER	12Volts/85ma	VOLTAGE VACUM	8500volts
	CONSUMPTION	0.010 A / hour	EFFECTIVE DISTANCE	10km
	POWER OUT	500ohms 0.6joules	DELIVERED POWER	1.2joules
	EXTRA SERVICE	Design For Customer <input type="checkbox"/>	OEM/ODM <input type="checkbox"/>	Develop New Item <input type="checkbox"/>
	STANDARD PACK	30Pcs/Ctn, Measure: 46*37*30cm, G.W/N.W: 22/21kgs		
	USD FOR	Bird Repellent		

	NAME	Easy Bird Control Shock Machine	ITEM NO.:	HC1654
	SIZE	18X11X45cm	WEIGHT	600g
	POWER	12Volts/85ma	VOLTAGE VACUM	8500volts
	CONSUMPTION	0.010 A / hour	EFFECTIVE DISTANCE	20km
	POWER OUT	500ohms 1.0joules	DELIVERED POWER	1.8joules
	EXTRA SERVICE	Design For Customer <input type="checkbox"/>	OEM/ODM <input type="checkbox"/>	Develop New Item <input type="checkbox"/>
	STANDARD PACK	30Pcs/Ctn, Measure: 46*37*30cm, G.W/N.W: 22/21kgs		
	USD FOR	Bird Repellent		





	NAME	Pro Bird Control Shock Machine	ITEM NO.:	HC1655
	SIZE	29X17X33cm	WEIGHT	2.5kgs
	POWER BY	9 volts or 12 volts or 110-230 volts (Adapter)		
	POWER	230 volts / 50 hz / 2 watts	VOLTAGE VACUM	9500 volts
	CONSUMPTION	0.05~0.11 A / hour	EFFECTIVE DISTANCE	5km
	POWER OUT	500ohms 0.25joules	DELIVERED POWER	1.0joules
	EXTRA SERVICE	Design For Customer <input type="checkbox"/>	OEM/ODM <input type="checkbox"/>	Develop New Item <input type="checkbox"/>
	STANDARD PACK	1Pc/Ctn, Measure: 31X19X35cm, G.W/N.W: 3/2.5kgs		
	USD FOR	Bird Repellent		

	NAME	Pro Bird Control Shock Machine	ITEM NO.:	HC1656
	SIZE	33X24X43cm	WEIGHT	600g
	POWER BY	12 volts or Solar		
	POWER	12 volts or Solar	VOLTAGE VACUM	12000volts
	CONSUMPTION	0.05~0.25 A / hour	EFFECTIVE DISTANCE	40km
	POWER OUT	500ohms 0.5~2.5 joules	DELIVERED POWER	6.2joules
	EXTRA SERVICE	Design For Customer <input type="checkbox"/>	OEM/ODM <input type="checkbox"/>	Develop New Item <input type="checkbox"/>
	STANDARD PACK	1Pcs/Ctn, Measure: 36X25X43.5cm, G.W/N.W: 6/5kgs		
	USD FOR	Bird Repellent		

	NAME	Solar Bird Control Shock Machine	ITEM NO.:	HC1661
	SIZE	27X26X21cm	WEIGHT	4.5 kg
	POWER BY	6 volts		
	POWER	6 volts	VOLTAGE VACUM	8500volts
	CONSUMPTION	40 mA / hour	EFFECTIVE DISTANCE	10km
	POWER OUT	500ohms 0.5joules	DELIVERED POWER	0.6joules
	EXTRA SERVICE	Design For Customer <input type="checkbox"/>	OEM/ODM <input type="checkbox"/>	Develop New Item <input type="checkbox"/>
	STANDARD PACK	1Pcs/Ctn, Measure: 35X26X28cm, G.W/N.W:6/5kgs		
	USD FOR	Bird Repellent		

	NAME	Solar Bird Control Shock Machine	ITEM NO.:	HC1662
	SIZE	20X8.5X7cm	WEIGHT	350g
	POWER BY	Solar Panel 2.4W/Lithium Battery 3.7 volts		
	POWER		VOLTAGE VACUM	6500volts
	CONSUMPTION	20MA / hour	EFFECTIVE DISTANCE	2km
	POWER OUT	500ohms 0.04joules	DELIVERED POWER	0.05joules
	EXTRA SERVICE	Design For Customer <input type="checkbox"/>	OEM/ODM <input type="checkbox"/>	Develop New Item <input type="checkbox"/>
	STANDARD PACK	10Pcs/Ctn, Measure:44.5x22x16cm , G.W/N.W:3.5/2.5kgs		
	USD FOR	Bird Repellent		

	NAME	Bird Shock Tracker	ITEM NO.:	HC1663
	SIZE	Length: 15m Width: 4cm	MATERIALER	PVC 1750g
	WIRE	Stainless Tracker		
	COLOUR	Transparent <input type="checkbox"/>	Red <input type="checkbox"/>	Black <input type="checkbox"/>
	EXTRA SERVICE	Design For Customer <input type="checkbox"/>	OEM/ODM <input type="checkbox"/>	Develop New Item <input type="checkbox"/>
	STANDARD PACK	4Pcs/Ctn, Measure: 30x30x20cm, G.W/N.W: 8/7kgs		
	USD FOR	Bird Repellent		

	NAME	Bird Shock Tracker	ITEM NO.:	HC1664
	SIZE	15m, Thickness: 7.5~3mm Width: 4cm	MATERIALER	PVC 4250g
	WIRE	7*7 Copper Tracker		
	COLOUR	Transparent <input type="checkbox"/>	Red <input type="checkbox"/>	Black <input type="checkbox"/>
	EXTRA SERVICE	Design For Customer <input type="checkbox"/>	OEM/ODM <input type="checkbox"/>	Develop New Item <input type="checkbox"/>
	STANDARD PACK	4Pcs/Ctn, Measure: 30x30x20cm, G.W/N.W: 18/17kgs		
	USD FOR	Bird Repellent		

	NAME	Bird Shock Tracker Fix Parts	ITEM NO.:	HC1665
	SIZE			
	MATERIAL	NYLON66+Stainless		
	EXTRA SERVICE	Design For Customer <input type="checkbox"/>	OEM/ODM <input type="checkbox"/>	Develop New Item <input type="checkbox"/>
	STANDARD PACK			
	USD FOR	Bird Repellent		

	NAME	Bird Shock Tracker Fix Parts	ITEM NO.:	HC1666
	SIZE			
	MATERIAL	NYLON66+Stainless		
	EXTRA SERVICE	Design For Customer <input type="checkbox"/>	OEM/ODM <input type="checkbox"/>	Develop New Item <input type="checkbox"/>
	STANDARD PACK			
	USD FOR	Bird Repellent		

	NAME	Fence Tester	ITEM NO.:	HC1668
	SIZE			
	EXTRA SERVICE	Design For Customer <input type="checkbox"/>	OEM/ODM <input type="checkbox"/>	Develop New Item <input type="checkbox"/>
	STANDARD PACK			
	USD FOR	Bird Repellent		

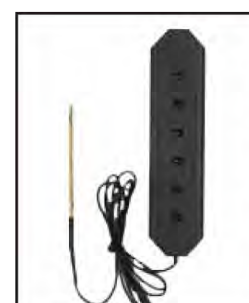
	NAME	Fence Tester	ITEM NO.:	HC1667
	SIZE			
	EXTRA SERVICE	Design For Customer <input type="checkbox"/>	OEM/ODM <input type="checkbox"/>	Develop New Item <input type="checkbox"/>
	STANDARD PACK			
	USD FOR	Bird Repellent		





	NAME	Flying Wing Owl Bird Control	ITEM NO.:	HC15014
	MATERIAL	HDPE Head+Tyvek	445g	
	SIZE	Head: 23x14x24cm, Wing Width: 113x50cm		
	STANDARD PACKING	30Pcs/Ctn, Measure: 63x47x63cm G.W/N.W: 14.35/13.35kgs		
	AMAZON PACK	1Pcs/Box, 6Boxes/Ctn, Measure: 35x31.5x65cm G.W/N.W: 4.9/3.35kgs		
	USE FOR	Farm, Fruit Trees or As an Ornament		

	NAME	Flying Wing Owl Bird Control	ITEM NO.:	HC1603
	MATERIAL	PE	251g	
	SIZE	54x37x9cm		
	STANDARD PACKING	12Pcs/Ctn, Measure: 59x33.5x26.5cm, G.W/N.W: 3.75/3kgs		
	AMAZON PACK	1Pc/Postbox, 6Box/Ctn.		
	USE FOR	Farm, Fruit Trees or As an Ornament		

	NAME	Plastic Owl Bird Control	ITEM NO.:	HC1601F
	MATERIAL	PE	350g	
	SIZE	Head: 40x17x18cm, Wing Width: 113x50cm		
	STANDARD PACKING	6Pcs/Ctn, Measure: 53x48x44cm, G.W/N.W: 2.9/1.9kgs		
	AMAZON PACK	1Pc/Postbox, 6Box/Ctn.		
	USE FOR	Farm, Fruit Trees or As an Ornament		

	NAME	Solar Plastic Owl Bird Control	ITEM NO.:	HC1610
	MATERIAL	PE	328.5g	
	SIZE	16x15x36cm		
	STANDARD PACKING	6Pcs/Ctn, Measure: 50x35x38cm, G.W/N.W: 2.7/1.7kgs		
	AMAZON PACK	1Pc/Postbox, 6Boxes/Ctn.		
	USE FOR	Farm, Fruit Trees or As an Ornament		

	NAME	Plastic Crow For Hunting	ITEM NO.:	HC1616S
	MATERIAL	PE	203g	
	SIZE	S: 38x11x13cm M: 40x12x20cm L: 40x58.8x.5cm		
	STANDARD PACKING	24Pcs/Ctn, Measure: 46x38x59cm, G.W/N.W: 5.6/4.8kgs		
	AMAZON PACK	1Pc/Postbox, 6 Boxes/Ctn.		
	USE FOR	Farm, Fruit Trees or As an Ornament		

	NAME	Head Moveable Plastic Owl Bird Control	ITEM NO.:	HC1602
	MATERIAL	PE	569.5g	
	POWDER FOR SHAKE	Wind		
	SIZE	Head: 16x17x42cm		
	STANDARD PACKING	6Pcs/Ctn, Measure: 58x40x47cm, G.W/N.W: 5/4kgs		
	AMAZON PACK	1Pc/Post Box, 6Boxes/Ctn		
USE FOR	Farm, Fruit Trees or As an Ornament			

	NAME	Head Moveable Plastic Owl Bird Control	ITEM NO.:	HC1611
	MATERIAL	PE	367g	
	POWDER FOR SHAKE	Wind		
	SIZE	50x36x47cm		
	STANDARD PACKING	6Pcs/Ctn, Measure: 63x50x55cm, G.W/N.W: 3.2/2.2kgs		
	AMAZON PACK	1Pc/Post Box, 6Boxes/Ctn		
USE FOR	Farm, Fruit Trees or As an Ornament			

	NAME	Head Moveable Plastic Owl Bird Control	ITEM NO.:	HC1612
	MATERIAL	PE	417g	
	POWDER FOR SHAKE	Wind		
	SIZE	20x16x38cm		
	STANDARD PACKING	1Pcs/Ctn, Measure: 51x43x40cm, G.W/N.W: 3.72/3kgs		
	AMAZON PACK	1Pc/Post Box, 6Boxes/Ctn		
USE FOR	Farm, Fruit Trees or As an Ornament			

	NAME	Head Moveable Plastic Owl Bird Control	ITEM NO.:	HC1614
	MATERIAL	PE	450g	
	POWDER FOR SHAKE	Wind		
	SIZE	19x18x41cm		
	STANDARD PACKING	6Pcs/Ctn, Measure: 56x40x45cm, G.W/N.W: 3.3/2.7KGS		
	AMAZON PACK	1Pc/Post Box, 6Boxes/Ctn		
USE FOR	Farm, Fruit Trees or As an Ornament			

	NAME	Plastic Owl Bird Control	ITEM NO.:	HC1615
	MATERIAL	PE	308g	
	POWDER FOR SHAKE	Wind		
	SIZE	19.5x22x40cm		
	STANDARD PACKING	6Pcs/Ctn, Measure: 60x45.5x42cm, G.W/N.W: 4.3/3.7kgs		
	AMAZON PACK	1Pc/Post Box, 6Boxes/Ctn		
USE FOR	Farm, Fruit Trees or As an Ornament			







BIRD CONTROL



Bird Control

	NAME	Bird Scarer Kite	ITEM NO.:	HC1631	
	SIZE	141x70cm	MATERIAL	Cloth+Flash PVC 111.5g	
	COLOUR	Black			
	PACKING	Bulk Pack <input type="checkbox"/>	White Box+Sticker <input type="checkbox"/>	Gift Box <input type="checkbox"/>	Head Card <input type="checkbox"/>
	EXTRA SERVICE	Design For Customer <input type="checkbox"/>		OEM/ODM <input type="checkbox"/>	Develop New Item <input type="checkbox"/>
	STANDARD	100Pcs/Ctn, Measure: 118x25x25cm , G.W/N.W: 12/11kgs			
	USD FOR	Scare All Kinds of Birds from Your Yard or the Garden			

	NAME	Bird Scarer Kite	ITEM NO.:	HC1632	
	SIZE	141x70cm	MATERIAL	Cloth+Flash PVC 111.5g	
	COLOUR	Black+Red Flash PVC Parts			
	PACKING	Bulk Pack <input type="checkbox"/>	White Box+Sticker <input type="checkbox"/>	Gift Box <input type="checkbox"/>	Head Card <input type="checkbox"/>
	EXTRA SERVICE	Design For Customer <input type="checkbox"/>		OEM/ODM <input type="checkbox"/>	Develop New Item <input type="checkbox"/>
	STANDARD	100Pcs/Ctn, Measure: 118x25x25cm, G.W/N.W: 12/11kgs			
	USD FOR	Scare All Kinds of Birds from Your Yard or the Garden			

	NAME	Bird Scarer Kite	ITEM NO.:	HC1633	
	SIZE	175x85.3cm	MATERIAL	Cloth+Flash PVC 88g	
	COLOUR	Gray			
	PACKING	Bulk Pack <input type="checkbox"/>	White Box+Sticker <input type="checkbox"/>	Gift Box <input type="checkbox"/>	Head Card <input type="checkbox"/>
	EXTRA SERVICE	Design For Customer <input type="checkbox"/>		OEM/ODM <input type="checkbox"/>	Develop New Item <input type="checkbox"/>
	STANDARD	125Pcs/Ctn, Measure: 118x25x25cm, G.W/N.W: 12/11kgs			
	USD FOR	Scare All Kinds of Birds from Your Yard or the Garden			

	NAME	Pro Bird Scarer Kite	ITEM NO.:	HC1634	
	SIZE	223x78cm	MATERIAL	Cloth+Flash PVC 134g	
	COLOUR	Red+Yellow+Red Flash PVC Parts			
	PACKING	Bulk Pack <input type="checkbox"/>	White Box+Sticker <input type="checkbox"/>	Gift Box <input type="checkbox"/>	Head Card <input type="checkbox"/>
	EXTRA SERVICE	Design For Customer <input type="checkbox"/>		OEM/ODM <input type="checkbox"/>	Develop New Item <input type="checkbox"/>
	STANDARD	125Pcs/Ctn, Measure: 118x25x25cm, G.W/N.W: 17.8/16.8kgs			
	USD FOR	Scare All Kinds of Birds from Your Yard or the Garden			

	NAME	Bird Scarer Kite Support	ITEM NO.:	HC1635	
	SIZE	4m	MATERIAL	PVC+ Fiberglass 400g	
	COLOUR	Black			
	PACKING	Bulk Pack <input type="checkbox"/>	White Box+Sticker <input type="checkbox"/>	Gift Box <input type="checkbox"/>	Head Card <input type="checkbox"/>
	EXTRA SERVICE	Design For Customer <input type="checkbox"/>		OEM/ODM <input type="checkbox"/>	Develop New Item <input type="checkbox"/>
	STANDARD	40Pcs/Ctn, Measure: 118x18x18cm, G.W/N.W: 17/16kgs			
	USD FOR	Scare All Kinds of Birds from Your Yard or the Garden			



	NAME	Bird Scarer Ball	ITEM NO.:	HC1604
	SIZE	Perimeter: 60cm	MATERIAL	PVC 0.2mm 120g
	COLOUR	Yellow <input type="checkbox"/> Black <input type="checkbox"/> White <input type="checkbox"/>	QTY PER UNIT	1yellow+1white+1black
	PACKING	Bulk Pack <input type="checkbox"/> White Box+Sticker <input type="checkbox"/>	Gift Box <input type="checkbox"/>	Head Card <input type="checkbox"/>
	EXTRA SERVICE	Design For Customer <input type="checkbox"/>	OEM/ODM <input type="checkbox"/>	Develop New Item <input type="checkbox"/>
	STANDARD	100Pcs/Ctn, 40Sets/Ctn, Measure: 45x44x26cm		
	USD FOR	Scare All Kinds of Birds from Your Yard or the Garden		

	NAME	Bird Repellent Flash Tape	ITEM NO.:	HC1616
	SIZE	2.5cmx100m	MATERIAL	PET 80g
	OTHER LENGTH	15m <input type="checkbox"/> 30m <input type="checkbox"/> 100m <input type="checkbox"/> 150m <input type="checkbox"/>	COLOUR	Red+Sliver
	PACKING	Bulk Pack <input type="checkbox"/> White Box+Sticker <input type="checkbox"/>	Gift Box <input type="checkbox"/>	Head Card <input type="checkbox"/>
	EXTRA SERVICE	Design For Customer <input type="checkbox"/>	OEM/ODM <input type="checkbox"/>	Develop New Item <input type="checkbox"/>
	STANDARD	100Pcs/Ctn, Measure: 34x28x21cm, G.W/N.W: 9.54/8.54kgs		
	USD FOR	Scare All Kinds of Birds from Your Yard or the Garden		

	NAME	Bird Repellent Flash Tape	ITEM NO.:	HC1617
	SIZE	2.5cmx100m	MATERIAL	PET 80g
	OTHER LENGTH	15m <input type="checkbox"/> 30m <input type="checkbox"/> 100m <input type="checkbox"/> 150m <input type="checkbox"/>	COLOUR	Flish Sliver
	PACKING	Bulk Pack <input type="checkbox"/> White Box+Sticker <input type="checkbox"/>	Gift Box <input type="checkbox"/>	Head Card <input type="checkbox"/>
	EXTRA SERVICE	Design For Customer <input type="checkbox"/>	OEM/ODM <input type="checkbox"/>	Develop New Item <input type="checkbox"/>
	STANDARD	100Pcs/Ctn, Measure: 34x28x21cm, G.W/N.W: 9.54/8.54kgs		
	USD FOR	Scare All Kinds of Birds from Your Yard or the Garden		

	NAME	Bird Repellent Flash Tape	ITEM NO.:	HC1618
	SIZE	5cmx30m	MATERIAL	PET 160g
	OTHER LENGTH	15m <input type="checkbox"/> 30m <input type="checkbox"/> 100m <input type="checkbox"/> 150m <input type="checkbox"/>	COLOUR	Flish Sliver
	PACKING	Bulk Pack <input type="checkbox"/> White Box+Sticker <input type="checkbox"/>	Gift Box <input type="checkbox"/>	Head Card <input type="checkbox"/>
	EXTRA SERVICE	Design For Customer <input type="checkbox"/>	OEM/ODM <input type="checkbox"/>	Develop New Item <input type="checkbox"/>
	STANDARD	50Pcs/Ctn, Measure: 34x28x21cm, G.W/N.W: 9/8kgs		
	USD FOR	Scare All Kinds of Birds from Your Yard or the Garden		

	NAME	Bird Scarer	ITEM NO.:	HC16122
	SIZE	48x15cm	MATERIAL	Stainless Steel 280g
	COLOUR	Sliver		
	PACKING	Bulk Pack <input type="checkbox"/> White Box+Sticker <input type="checkbox"/>	Gift Box <input type="checkbox"/>	Head Card <input type="checkbox"/>
	EXTRA SERVICE	Design For Customer <input type="checkbox"/>	OEM/ODM <input type="checkbox"/>	Develop New Item <input type="checkbox"/>
	STANDARD	20Pcs/Ctn, Measure: 50x25x40cm, G.W/N.W: 15/14kgs		
	USD FOR	Scare All Kinds of Birds from Your Yard or the Garden		

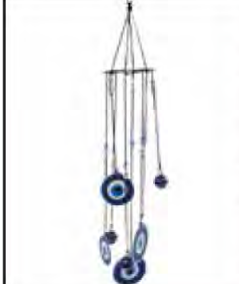
	NAME	Bird Scarer	ITEM NO.:	HC1601
	SIZE	43x9.5cm	MATERIAL	Stainless Steel 251g
	COLOUR	Sliver		
	PACKING	Bulk Pack <input type="checkbox"/> White Box+Sticker <input type="checkbox"/>	Gift Box <input type="checkbox"/>	Head Card <input type="checkbox"/>
	EXTRA SERVICE	Design For Customer <input type="checkbox"/>	OEM/ODM <input type="checkbox"/>	Develop New Item <input type="checkbox"/>
	STANDARD	1Pc/Box, 20Box/Ctn, Measure: 15.5x15.5x3.5cm, G.W/N.W: 6.5/5.5kgs		
	USD FOR	Scare All Kinds of Birds from Your Yard or the Garden		

	NAME	Bird Scarer	ITEM NO.:	HC1605S
	SIZE	30CM	MATERIAL	Acrylic 11.5g
	COLOUR	Sliver	QTY PER UNIT	Any qty
	PACKING	Bulk Pack <input type="checkbox"/> White Box+Sticker <input type="checkbox"/>	Gift Box <input type="checkbox"/>	Head Card <input type="checkbox"/>
	EXTRA SERVICE	Design For Customer <input type="checkbox"/>	OEM/ODM <input type="checkbox"/>	Develop New Item <input type="checkbox"/>
	STANDARD	640Pcs/Ctn, Measure: 43x18x17cm, G.W/N.W: 8.4/7.4kgs		
	USD FOR	Scare All Kinds of Birds from Your Yard or the Garden		

	NAME	Bird Scarer Ball	ITEM NO.:	HC1605
	SIZE	30CM <input type="checkbox"/> 40CM <input type="checkbox"/> 50CM <input checked="" type="checkbox"/> 70CM <input type="checkbox"/>	MATERIAL	Acrylic 22g
	COLOUR	Sliver <input type="checkbox"/> Red <input type="checkbox"/> Green <input type="checkbox"/> Blonde <input type="checkbox"/>	QTY PER UNIT	Any Qty
	PACKING	Bulk Pack <input type="checkbox"/> White Box+Sticker <input type="checkbox"/>	Gift Box <input type="checkbox"/>	Head Card <input type="checkbox"/>
	EXTRA SERVICE	Design For Customer <input type="checkbox"/>	OEM/ODM <input type="checkbox"/>	Develop New Item <input type="checkbox"/>
	STANDARD	500Pcs/Ctn, Measure: 50x45x45cm, G.W/N.W: 12/11kgs		
	USD FOR	Scare All Kinds of Birds from Your Yard or the Garden		

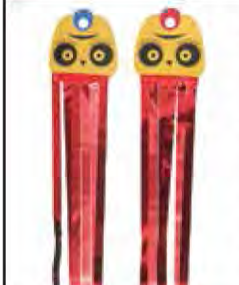
	NAME	Bird Scarer	ITEM NO.:	HC1637
	SIZE	21x19cm Length: 60cm	MATERIAL	PVC+PET Flash Tape 32.5g
	COLOUR	Yellow+Red+Sliver Flash		
	PACKING	Bulk Pack <input type="checkbox"/> White Box+Sticker <input type="checkbox"/>	Gift Box <input type="checkbox"/>	Head Card <input type="checkbox"/>
	EXTRA SERVICE	Design For Customer <input type="checkbox"/>	OEM/ODM <input type="checkbox"/>	Develop New Item <input type="checkbox"/>
	STANDARD	100Pcs/Bag, 10Bags/Inner Box, 20Boxes/Ctn, Measure: 35x25x30cm G.W: 4/3.25kgs		
	USD FOR	Scare All Kinds of Birds from Your Yard or the Garden		

	NAME	Bird Scarer	ITEM NO.:	HC1621
	SIZE	29x14.5cm	MATERIALE	PVC 19g
	COLOUR	Flash Sliver		
	PACKING	Bulk Pack <input type="checkbox"/> White Box+Sticker <input type="checkbox"/>	Gift Box <input type="checkbox"/>	Head Card <input type="checkbox"/>
	EXTRA SERVICE	Design For Customer <input type="checkbox"/>	OEM/ODM <input type="checkbox"/>	Develop New Item <input type="checkbox"/>
	STANDARD	2Pcs/Bag, 100Bags/Ctn, Measure: 55x30x30cm, G.W/N.W: 4.8/3.8kgs		
	USD FOR	Scare All Kinds of Birds from Your Yard or the Garden		





	NAME	Bird Repellent Flash Owl	ITEM NO.:	HC1623
	SIZE	28.4x14.6cm	MATERIAL	PVC 19g
	COLOUR	Flash Sliver		
	PACKING	Bulk Pack <input type="checkbox"/> White Box+Sticker <input type="checkbox"/>	Gift Box <input type="checkbox"/>	Head Card <input type="checkbox"/>
	EXTRA SERVICE	Design For Customer <input type="checkbox"/>	OEM/ODM <input type="checkbox"/>	Develop New Item <input type="checkbox"/>
	STANDARD	2Pcs/Bag, 100Bags/Ctn, Measure: 30x22x30cm, G.W/N.W: 4.8/3.8kgs		
	USD FOR	Scare All Kinds of Birds from Your Yard or the Garden		

	NAME	Bird Repellent Flash Owl	ITEM NO.:	HC1624
	SIZE	39.7x21.4cm	MATERIAL	PVC 50g
	COLOUR	Flash Sliver		
	PACKING	Bulk Pack <input type="checkbox"/> White Box+Sticker <input type="checkbox"/>	Gift Box <input type="checkbox"/>	Head Card <input type="checkbox"/>
	EXTRA SERVICE	Design For Customer <input type="checkbox"/>	OEM/ODM <input type="checkbox"/>	Develop New Item <input type="checkbox"/>
	STANDARD	2Pcs/Bag, 100Bags/Ctn, Measure: 42x25x30cm, G.W/N.W: 11/10kgs		
	USD FOR	Scare All Kinds of Birds from Your Yard or the Garden		

	NAME	Bird Repellent Flash Eagle	ITEM NO.:	HC1625
	SIZE	40x22cm	MATERIAL	PVC 30g
	COLOUR	Flash Sliver		
	PACKING	Bulk Pack <input type="checkbox"/> White Box+Sticker <input type="checkbox"/>	Gift Box <input type="checkbox"/>	Head Card <input type="checkbox"/>
	EXTRA SERVICE	Design For Customer <input type="checkbox"/>	OEM/ODM <input type="checkbox"/>	Develop New Item <input type="checkbox"/>
	STANDARD	2Pcs/Bag, 100Bags/Ctn, Measure: 42x42x30cm, G.W/N.W: 7/6kgs		
	USD FOR	Scare All Kinds of Birds from Your Yard or the Garden		

	NAME	Bird Repellent Flash	ITEM NO.:	HC1626
	SIZE	13x8.3cm	MATERIAL	PVC 7.5g
	COLOUR	Flash Sliver		
	PACKING	Bulk Pack <input type="checkbox"/> White Box+Sticker <input type="checkbox"/>	Gift Box <input type="checkbox"/>	Head Card <input type="checkbox"/>
	EXTRA SERVICE	Design For Customer <input type="checkbox"/>	OEM/ODM <input type="checkbox"/>	Develop New Item <input type="checkbox"/>
	STANDARD	500Pcs/Ctn, Measure: 40x30x20cm, G.W/N.W: 4.75/3.75kgs		
	USD FOR	Scare All Kinds of Birds from Your Yard or the Garden		

	NAME	Bird Repellent Flash Eyes	ITEM NO.:	HC1626S
	SIZE	13x8.3cm	MATERIAL	PVC 22.5g
	COLOUR	Flash Sliver		
	PACKING	Bulk Pack <input type="checkbox"/> White Box+Sticker <input type="checkbox"/>	Gift Box <input type="checkbox"/>	Head Card <input type="checkbox"/>
	EXTRA SERVICE	Design For Customer <input type="checkbox"/>	OEM/ODM <input type="checkbox"/>	Develop New Item <input type="checkbox"/>
	STANDARD	200Pcs/Ctn, Measure: 40x30x20cm, G.W/N.W:5.5/4.5kgs		
	USD FOR	Scare All Kinds of Birds from Your Yard or the Garden		

	NAME	Bird Repellent Cat	ITEM NO.:	HC1627
	SIZE	25.5x17cm, 25.6x16cm, 26.5x15cm	MATERIAL	PVC <input type="checkbox"/> Steel <input type="checkbox"/>
	COLOUR	Flash Sliver		228g
	PACKING	Bulk Pack <input type="checkbox"/> White Box+Sticker <input type="checkbox"/>	Gift Box <input type="checkbox"/>	Head Card <input type="checkbox"/>
	EXTRA SERVICE	Design For Customer <input type="checkbox"/>	OEM/ODM <input type="checkbox"/>	Develop New Item <input type="checkbox"/>
	STANDARD	2Pcs/bag, 20Bags/Ctn, Measure: 44.5x20x20cm, G.W/N.W:10/9.2kg		
	USD FOR	Scare All Kinds of Birds from Your Yard or the Garden		

	NAME	Bird Repellent Flash Face	ITEM NO.:	HC1628
	SIZE	10.5x8.5cm	MATERIAL	PVC 7g
	COLOUR	Flash Sliver		
	PACKING	Bulk Pack <input type="checkbox"/> White Box+Sticker <input type="checkbox"/>	Gift Box <input type="checkbox"/>	Head Card <input type="checkbox"/>
	EXTRA SERVICE	Design For Customer <input type="checkbox"/>	OEM/ODM <input type="checkbox"/>	Develop New Item <input type="checkbox"/>
	STANDARD	4Pcs/Bag, 120Bags/Ctn, Measure: 36x25x27cm, G.W/N.W:4.5/3.5kgs		
	USD FOR	Scare All Kinds of Birds from Your Yard or the Garden		

	NAME	Bird Repellent Flash Windmill	ITEM NO.:	HC1629
	SIZE	19x47.5cm	MATERIAL	PVC 22g
	COLOUR	Flash Sliver		
	PACKING	Bulk Pack <input type="checkbox"/> White Box+Sticker <input type="checkbox"/>	Gift Box <input type="checkbox"/>	Head Card <input type="checkbox"/>
	EXTRA SERVICE	Design For Customer <input type="checkbox"/>	OEM/ODM <input type="checkbox"/>	Develop New Item <input type="checkbox"/>
	STANDARD	8Pcs/Bag, 20Bags/Ctn, Measure: 35x24x32cm, G.W/N.W: 4.6/3.6kgs		
	USD FOR	Scare All Kinds of Birds from Your Yard or the Garden		

	NAME	Bird Repellent Flash Windmill	ITEM NO.:	HC1629S
	SIZE	19x47.5cm	MATERIAL	PVC 22g
	COLOUR	Gradient Ramp Color		
	PACKING	Bulk Pack <input type="checkbox"/> White Box+Sticker <input type="checkbox"/>	Gift Box <input type="checkbox"/>	Head Card <input type="checkbox"/>
	EXTRA SERVICE	Design For Customer <input type="checkbox"/>	OEM/ODM <input type="checkbox"/>	Develop New Item <input type="checkbox"/>
	STANDARD	8Pcs/Bag, 20Bags/Ctn, Measure: 35x24x32cm, G.W/N.W: 4.6/3.6kgs		
	USD FOR	Scare All Kinds of Birds from Your Yard or the Garden		

	NAME	Bird Repellent Flash Face	ITEM NO.:	HC1630
	SIZE	φ10cm	MATERIAL	Stainless Steel 39.5g
	COLOUR	Sliver Mirror		
	PACKING	Bulk Pack <input type="checkbox"/> White Box+Sticker <input type="checkbox"/>	Gift Box <input type="checkbox"/>	Head Card <input type="checkbox"/>
	EXTRA SERVICE	Design For Customer <input type="checkbox"/>	OEM/ODM <input type="checkbox"/>	Develop New Item <input type="checkbox"/>
	STANDARD	8Pcs/Set, 50Sets/Ctn, Measure: 27x21x20cm, G.W/N.W: 12.2/11.2kgs		
	USD FOR	Scare All Kinds of Birds from Your Yard or the Garden		



ANTI-BIRD COLLISION GLASS WINDOWS STICKER





	NAME	Glass Windows Bird Proof Sticker		ITEM NO	HC1636
	SIZE	215x307mm		MATERIAL	PVC 82.5g
	COLOUR	Black			
	PACKING	Bulk Pack <input type="checkbox"/>	White Box+Sticker <input type="checkbox"/>	Gift Box <input type="checkbox"/>	Head Card <input type="checkbox"/>
	EXTRA SERVICE	Design For Customer <input type="checkbox"/>	OEM/ODM <input type="checkbox"/>	Develop New Item <input type="checkbox"/>	
	STANDARD				
	USD FOR	Scare All Kinds of Birds from Your Yard or the Garden			

BIRDCONTRIL



	NAME	Pro Bird Control Shock Machine	ITEM NO.:	HC1701	
	SIZE	18.5x13.5x9cm	MATERIAL	ABS+IC	
	INPUT VOLTAGE	Battery			
	PACKING	Bulk Pack <input type="checkbox"/>	White Box+Sticker <input type="checkbox"/>	Gift Box <input type="checkbox"/>	Head Card <input type="checkbox"/>
	EXTRA SERVICE	Design For Customer <input type="checkbox"/>	OEM/ODM <input type="checkbox"/>	Develop New Item <input type="checkbox"/>	
	STANDARD	20Pcs/Ctn, Measure: 53.5x52.5x52.5cm, G.W/N.W: 19/18kgs			
	USD FOR	Scare All Kinds of Birds from Your Yard or the Garden			

	NAME	Pro Bird Control Shock Machine	ITEM NO.:	HC1702	
	SIZE	15.5x23x10 cm 900 g	MATERIAL	ABS+IC	
	INPUT VOLTAGE	12 volts Or Solar Panels			
	PACKING	Bulk Pack <input type="checkbox"/>	White Box+Sticker <input type="checkbox"/>	Gift Box <input type="checkbox"/>	Head Card <input type="checkbox"/>
	EXTRA SERVICE	Design For Customer <input type="checkbox"/>	OEM/ODM <input type="checkbox"/>	Develop New Item <input type="checkbox"/>	
	STANDARD	20Pcs/Ctn, Measure: 56x32.5x55cm, G.W/N.W: 23/20kgs			
	USD FOR	Scare All Kinds of Birds from Your Yard or the Garden			

	NAME	Pro Bird Control Shock Machine	ITEM NO.:	HC1704	
	SIZE	23x23x13 cm	MATERIAL	ABS+IC	
	COLOUR	12 volts Or Solar Panels			
	PACKING	Bulk Pack <input type="checkbox"/>	White Box+Sticker <input type="checkbox"/>	Gift Box <input type="checkbox"/>	Head Card <input type="checkbox"/>
	EXTRA SERVICE	Design For Customer <input type="checkbox"/>	OEM/ODM <input type="checkbox"/>	Develop New Item <input type="checkbox"/>	
	STANDARD	20Pcs/Ctn, Measure: 47x30.5x33cm, G.W/N.W: 8.5/7.5kgs			
	USD FOR	*4-Speaker System-Includes 4 Independent Speakers With 100 Ft. Of Wire Each			

	NAME	Pro Bird Control Shock Machine	ITEM NO.:	HC1705	
	SIZE	23x23x13 Cm	MATERIAL	ABS+IC	
	INPUT VOLTAGE	12 Volts Or Solar Panels			
	PACKING	Bulk Pack <input type="checkbox"/>	White Box+Sticker <input type="checkbox"/>	Gift Box <input type="checkbox"/>	Head Card <input type="checkbox"/>
	EXTRA SERVICE	Design For Customer <input type="checkbox"/>	OEM/ODM <input type="checkbox"/>	Develop New Item <input type="checkbox"/>	
	STANDARD	2pcs/ctn, Measure: 47x30.5x33cm, G.W/n.w: 8.5/7.5kgs			
	USD FOR	*4-speaker System-includes 4 Independent Speakers With 100 Ft. Of Wire Each			

	NAME	Pro Bird Control Shock Machine	ITEM NO.:	HC1706	
	SIZE	23x23x13cm	MATERIAL	ABS+IC	
	INPUT VOLTAGE	12 volts Or Solar Panels			
	PACKING	Bulk Pack <input type="checkbox"/>	White Box+Sticker <input type="checkbox"/>	Gift Box <input type="checkbox"/>	Head Card <input type="checkbox"/>
	EXTRA SERVICE	Design For Customer <input type="checkbox"/>	OEM/ODM <input type="checkbox"/>	Develop New Item <input type="checkbox"/>	
	STANDARD	20Pcs/Ctn, Measure: 48x48x42.5cm, G.W/N.W: 8.5/7.5kgs			
	USD FOR				

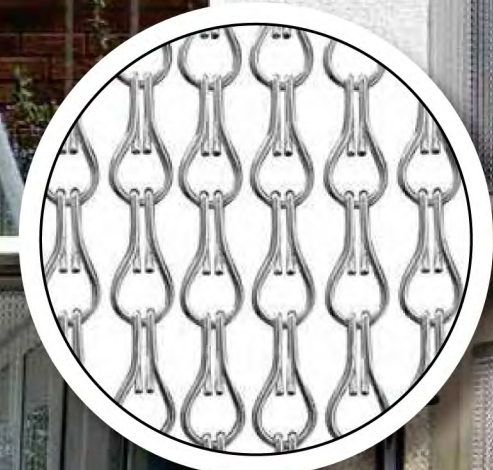

NAME	Aluminium Curtain Screen	ITEM NO	HC5528A
SIZE	90X210CM (1.6mm)	MATERIAL	Aluminium
EXTRA SERVICE	Design For Customer <input type="checkbox"/>	OEM/ODM <input type="checkbox"/>	Develop New Item <input type="checkbox"/>
PACKING	Bulk Pack <input type="checkbox"/>	White Box+Sticker <input type="checkbox"/>	Gift Box <input type="checkbox"/>
STANDARD	125Pcs/Ctn, Measure:118x25x25cm , G.W/N.W:12/11kgs		



ANTI CAT NETWORK

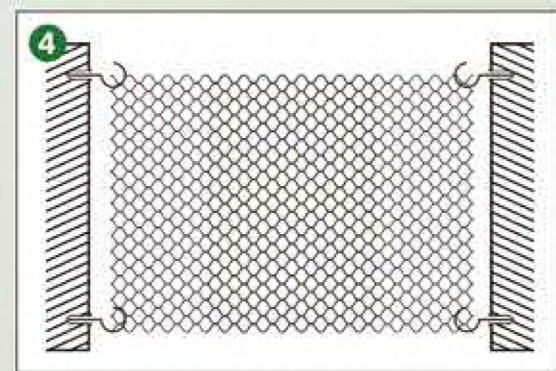
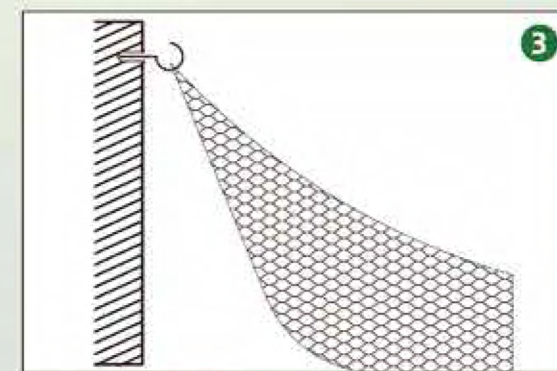
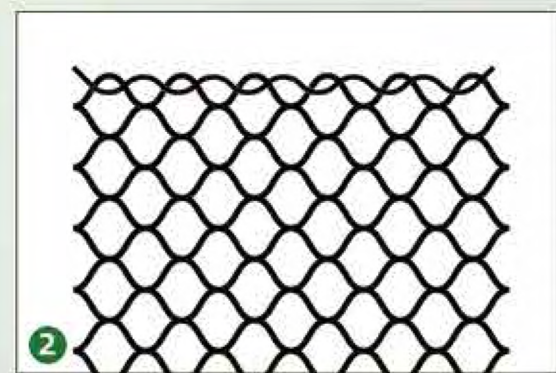
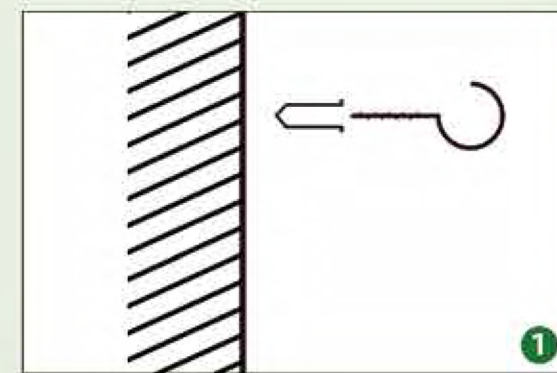





	NAME	Normal Mist Bird Net		ITEM NO.:	HC1401-N	
	MATERIAL	Nylon	CUT SHAPE	70d*2Ply <input type="checkbox"/>	110d*2Ply <input type="checkbox"/>	
	MESH SIZE	16mm (3/5")	POCKETS	3pocket <input type="checkbox"/>	4pocket <input type="checkbox"/>	
	ROPE TYPE	2Ply	KNOT TYPE	Knotted	COLOUR	Black <input type="checkbox"/>
	NET SIZE	2.1x6m, 2.1x9m, 2.1x12m, 2.1x15m, 3x6m, 3x9m, 3x12m, 3x15m				
	PACKING	Bulk Pack <input type="checkbox"/>	White Box+Sticker <input type="checkbox"/>	Gift Box <input type="checkbox"/>	Head Card <input type="checkbox"/>	
	STANDARD PACKING	3x6m: 100Pcs/Ctn, Measure: 50x50x50cm, G.W/N.W: 18/17kgs				
	USE FOR	Bird Banding Department For Bird Study				

	NAME	Pro Bird Banding Mist Bird Net		ITEM NO.:	HC1401-P	
	MATERIAL	Nylon	CUT SHAPE	70d*2Ply <input type="checkbox"/>	110d*2Ply <input type="checkbox"/>	
	MESH SIZE	16mm (3/5")	POCKETS	3pocket <input type="checkbox"/>	4pocket <input type="checkbox"/>	
	ROPE TYPE	2Ply	KNOT TYPE	Knotted	COLOUR	Black <input type="checkbox"/>
	NET SIZE	2.1x6m, 2.1x9m, 2.1x12m, 2.1x15m, 3x6m, 3x9m, 3x12m, 3x15m				
	PACKING	Bulk Pack <input type="checkbox"/>	White Box+Sticker <input type="checkbox"/>	Gift Box <input type="checkbox"/>	Head Card <input type="checkbox"/>	
	STANDARD PACKING	3x6m: 100Pcs/Ctn, Measure: 50x50x50cm, G.W/N.W: 18/17kgs				
	USE FOR	Bird Banding Department For Bird Study				

	NAME	Foldable Pigeon Trap		ITEM NO.:	HC1607	
	MATERIAL	Steel Wire 6800g	WIRE DIA	2.4mm	MESH SIZE	5x5cm
	SIZE	95x60x32cm				
	COLOUR	Sliver <input type="checkbox"/>	White <input type="checkbox"/>	Green <input type="checkbox"/>		
	PACKING	1Pc/Ctn, Size: 62.5x3.5x98.5cm G.W/N.W: 7.8/6.8kgs				
	USE FOR	Catch Wild Birds				

	NAME	Pigeon Trap		ITEM NO.:	HC1607-S	
	MATERIAL	Steel Wire 1280g	WIRE DIA	2.4mm	MESH SIZE	5x5cm
	SIZE	30x30x30cm				
	COLOUR	Sliver <input type="checkbox"/>	White <input type="checkbox"/>	Green <input type="checkbox"/>		
	PACKING	Bulk Pack <input type="checkbox"/>				
	STANDARD	1Pcs/Ctn, Measure: 35x35x33.5cm, G.W/N.W: 2/1.28kgs				
USE FOR	Catch Birds					

	NAME	Pigeon Trap		ITEM NO.:	HC1608	
	MATERIAL	HDPE 257g	WIRE DIA	2.4mm	MESH SIZE	5x5cm
	SIZE	7cm, 9cm, 13cm, 16cm, 28cm				
	PACKING	Bulk Pack <input type="checkbox"/>	white Box+Sticker <input type="checkbox"/>	Gift Box <input type="checkbox"/>	Head Card <input type="checkbox"/>	
	STANDARD	100Pc/Ctn, G.W/N.W: 26.7/25.7kgs				
	USE FOR	Catch Wild Birds				

Advantages of our Bird Wire:

- Long lasting, humane, nearly invisible bird control products
- Many models for different people's hobby
- Easily screwed to any substrate
- Low cost with professional design



HC1201 Bird Coil

Material: Dia 1.3mm 304SUS
Length: 7.5m
Dia: Outdia: 10cm

HC1201S
Bird Coil Install Base
Spe: SUS304sheet.
3pcs/Set



Install Pictures

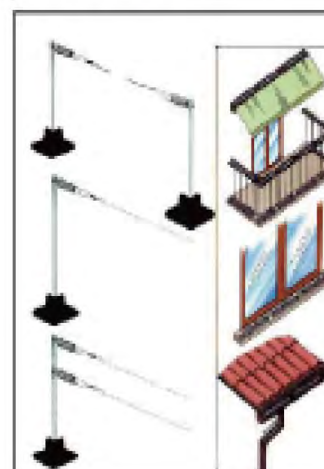

HC1202 Bird Wire

Base: can be Nylon or Stainless and either the Stainless Sheet
Length: 50cm, 60cm, 80cm, 100cm, 120cm, 150cm for chose

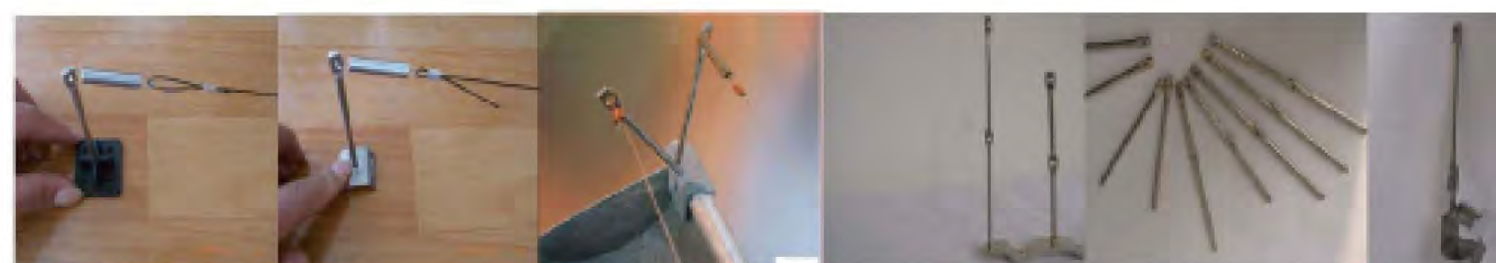
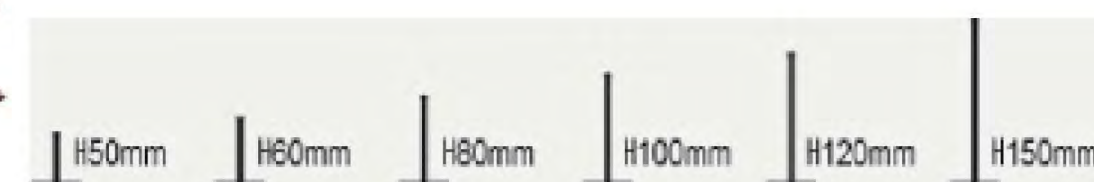

HC1202	HC1203	HC1204	HC1205	HC1206	HC1207
Nylon Base Supporter	Metal Base Supporter	Nylon Base Supporter	Metal Base Supporter	All Kinds Supporter	Supporter



Description:

Super resistance to external attack, can place snaptrap inside, can detect mouse density.

Place and fix the station at a level ground slightly higher than the surrounding area and without any gaps to the wall base.

Suitable for places with large impact of external forces, such as parking lots.

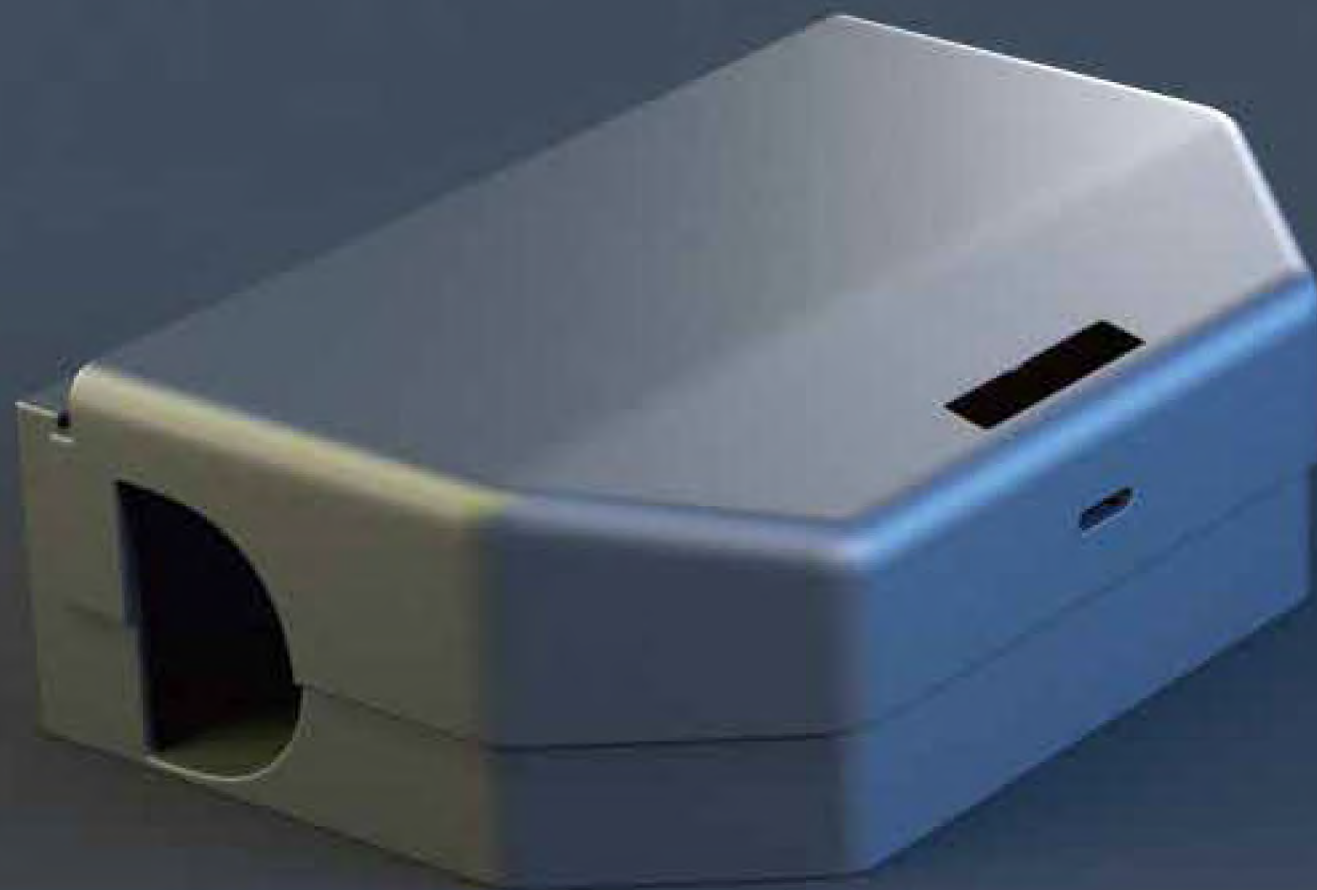

HC16228

HC2101



Description:

Raised design on lid with locks on it, inside there is detachable independent casting slot.

Fix the plastic board directly on the wall, and install the rat bait station on the wall base without gaps;

Place and install the station at a level ground slightly higher than the surrounding area where rodents often move.





Rodent Control

	NAME	ECO Rodent Bait Station	ITEM NO.:	HC2101
	SIZE	23x19x9.5cm	MATERIAL	Durable PP 408g
	ACCESSORY PARTS	Key <input type="checkbox"/>	Wall Parts <input type="checkbox"/>	Steel Bar <input type="checkbox"/>
	EXTRA SERVICE	Design For Customer <input type="checkbox"/>	OEM/ODM <input type="checkbox"/>	Develop New Item <input type="checkbox"/>
	PACKING	Bulk Pack <input type="checkbox"/>	White Box+Sticker <input type="checkbox"/>	Gift Box <input type="checkbox"/>
	STANDARD	20Pcs/Ctn, Measure: 46x38x48cm, G.W/N.W: 9.05/8.05kgs		
	USE FOR	For Put Rodenticide, Also Can Be As The Protect Cover Of The Snap Traps ,To Protect The Pets And The Children For PCO Guys And House Use		

	NAME	Easy Rodent Bait Station	ITEM NO.:	HC2114
	SIZE	30x12x10.3cm	MATERIAL	Durable PP
	ACCESSORY PARTS	Key <input type="checkbox"/>	Wall Parts <input type="checkbox"/>	Steel Bar <input type="checkbox"/>
	EXTRA SERVICE	Design For Customer <input type="checkbox"/>	OEM/ODM <input type="checkbox"/>	Develop New Item <input type="checkbox"/>
	PACKING	Bulk Pack <input type="checkbox"/>	White Box+Sticker <input type="checkbox"/>	Gift Box <input type="checkbox"/>
	STANDARD	24Pcs/Ctn, Measure: 53X32X55cm, G.W/N.W: 6/5kgs		
	USE FOR	For Put Rodenticide, Also Can Be As The Protect Cover Of The Snap Traps ,To Protect The Pets And The Children For PCO Guys And House Use		

	NAME	ECO Rodent Bait Station	ITEM NO.:	HC2102
	SIZE	21.5x17.5x9.3CM	MATERIAL	Durable PP 400g
	ACCESSORY PARTS	Key <input type="checkbox"/>	Wall Parts <input type="checkbox"/>	Steel Bar <input type="checkbox"/>
	EXTRA SERVICE	Design For Customer <input type="checkbox"/>	OEM/ODM <input type="checkbox"/>	Develop New Item <input type="checkbox"/>
	PACKING	Bulk Pack <input type="checkbox"/>	White Box+Sticker <input type="checkbox"/>	Gift Box <input type="checkbox"/>
	STANDARD	20Pcs/Ctn, Measure: 46x38x48cm, G.W/N.W: 9.0/8.0kgs		
	USE FOR	For Put Rodenticide, Also Can Be As The Protect Cover Of The Snap Traps ,To Protect The Pets And The Children For PCO Guys And House Use		

	NAME	Easy Rodent Bait Station	ITEM NO.:	HC2114P
	SIZE	30.5x10.4x10.2cm	MATERIAL	Durable PP 300g
	ACCESSORY PARTS	Key <input type="checkbox"/>	Wall Parts <input type="checkbox"/>	Steel Bar <input type="checkbox"/>
	EXTRA SERVICE	Design For Customer <input type="checkbox"/>	OEM/ODM <input type="checkbox"/>	Develop New Item <input type="checkbox"/>
	PACKING	Bulk Pack <input type="checkbox"/>	White Box+Sticker <input type="checkbox"/>	Gift Box <input type="checkbox"/>
	STANDARD	20Pcs/Ctn, Measure: 54x32x42cm, G.W/N.W: 7.0/6.0kgs		
	USE FOR	For Put Rodenticide, Also Can Be As The Protect Cover Of The Snap Traps ,To Protect The Pets And The Children For PCO Guys And House Use		

	NAME	Rodent Bait Station	ITEM NO.:	HC2103
	SIZE	33x20x10cm	MATERIAL	Heavy Duty PP 600g
	ACCESSORY PARTS	Key <input type="checkbox"/>	Wall Parts <input type="checkbox"/>	Steel Bar <input type="checkbox"/>
	EXTRA SERVICE	Design For Customer <input type="checkbox"/>	OEM/ODM <input type="checkbox"/>	Develop New Item <input type="checkbox"/>
	PACKING	Bulk Pack <input type="checkbox"/>	White Box+Sticker <input type="checkbox"/>	Gift Box <input type="checkbox"/>
	STANDARD	10Pcs/Ctn, Measure: 56x36x44cm, G.W/N.W: 7/6kgs		
	USE FOR	For Put Rodenticide, Also Can Be As The Protect Cover Of The Snap Traps ,To Protect The Pets And The Children For PCO Guys And House Use		

	NAME	Easy Rodent Bait Station	ITEM NO.:	HC2118
	SIZE	34.2x23.2x11.2cm	MATERIAL	Heavy Duty PP 800g
	ACCESSORY PARTS	Key <input type="checkbox"/>	Wall Parts <input type="checkbox"/>	Steel Bar <input type="checkbox"/>
	EXTRA SERVICE	Design For Customer <input type="checkbox"/>	OEM/ODM <input type="checkbox"/>	Develop New Item <input type="checkbox"/>
	PACKING	Bulk Pack <input type="checkbox"/>	White Box+Sticker <input type="checkbox"/>	Gift Box <input type="checkbox"/>
	STANDARD	20Pcs/Ctn, Measure: 58.5X36.5X49.5cm, G.W/N.W:17/16kgs		
	USE FOR	For Put Rodenticide, Also Can Be As The Protect Cover Of The Snap Traps ,To Protect The Pets And The Children For PCO Guys And House Use		

	NAME	Waterproof Rodent Bait Station	ITEM NO.:	HC16228/HC2128
	SIZE	33x23.5x11cm	MATERIAL	Durable PP 710g
	ACCESSORY PARTS	Key <input type="checkbox"/>	Wall Parts <input type="checkbox"/>	Steel Bar <input type="checkbox"/>
	EXTRA SERVICE	Design For Customer <input type="checkbox"/>	OEM/ODM <input type="checkbox"/>	Develop New Item <input type="checkbox"/>
	PACKING	Bulk Pack <input type="checkbox"/>	White Box+Sticker <input type="checkbox"/>	Gift Box <input type="checkbox"/>
	STANDARD	10Pcs/Ctn,Measure:55.5x35x50cm G.W/N.W: 8.1/7.1kgs		
	USE FOR	For Put Rodenticide, Also Can Be As The Protect Cover Of The Snap Traps ,To Protect The Pets And The Children For PCO Guys And House Use		

	NAME	Locked-Multi Use Stainless Bait Station	ITEM NO.:	HC2114L
	SIZE	41.7X8.8X9CM	MATERIAL	SUS201/Galvanized Steel
	ACCESSORY PARTS	Key <input type="checkbox"/> Lock <input type="checkbox"/>	Wall Parts <input type="checkbox"/>	Steel Bar <input type="checkbox"/>
	EXTRA SERVICE	Design For Customer <input type="checkbox"/>	OEM/ODM <input type="checkbox"/>	Develop New Item <input type="checkbox"/>
	PACKING	Bulk Pack <input type="checkbox"/>	White Box+Sticker <input type="checkbox"/>	Gift Box <input type="checkbox"/>
	STANDARD	20Pcs/Ctn, Measure: 48x45x43cm		
	USE FOR	Multi Use Stainless Bait Station-Snap Trap Cover-Gule Board Cover For Put Rodenticide, Also Can Be As The Protect Cover Of The Snap Traps		

	NAME	Easy Rodent Bait Station	ITEM NO.:	HC16228S/HC2128S
	SIZE	24.8x19x11cm	MATERIAL	Durable PP 460g
	ACCESSORY PARTS	Key <input type="checkbox"/>	Wall Parts <input type="checkbox"/>	Steel Bar <input type="checkbox"/>
	EXTRA SERVICE	Design For Customer <input type="checkbox"/>	OEM/ODM <input type="checkbox"/>	Develop New Item <input type="checkbox"/>
	PACKING	Bulk Pack <input type="checkbox"/>	White Box+Sticker <input type="checkbox"/>	Gift Box <input type="checkbox"/>
	STANDARD	20Pcs/Ctn, Measure: 51.5x39.5x58.5cm, G.W/N.W: 10.2/9.2kgs		
	USE FOR	For Put Rodenticide, Also Can Be As The Protect Cover Of The Snap Traps ,To Protect The Pets And The Children For PCO Guys And House Use		

	NAME	Locked-Multi Use Stainless Bait Station	ITEM NO.:	HC2114S
	SIZE	25.5X10.5X10.2CM	MATERIAL	SUS201/Galvanized Steel
	ACCESSORY PARTS	Key <input type="checkbox"/> Lock <input type="checkbox"/>	Wall Parts <input type="checkbox"/>	Steel Bar <input type="checkbox"/>
	EXTRA SERVICE	Design For Customer <input type="checkbox"/>	OEM/ODM <input type="checkbox"/>	Develop New Item <input type="checkbox"/>
	PACKING	Bulk Pack <input type="checkbox"/>	White Box+Sticker <input type="checkbox"/>	Gift Box <input type="checkbox"/>
	STANDARD	12Pcs/Ctn, Measure: 56X43X50CM		
	USE FOR	Multi Use Stainless Bait Station-Snap Trap Cover-Gule Board Cover For Put Rodenticide, Also Can Be As The Protect Cover Of The Snap Traps		

2114-2114s做海报-整页





Rodent Control

	NAME	Easy Mouse Bait Station	ITEM NO.:	HC2105
	SIZE	12.7x9.6x4cm	MATERIAL	Durable PP 65g
	ACCESSORY PARTS	Key <input type="checkbox"/>		Steel Bar <input type="checkbox"/>
	EXTRA SERVICE	Design For Customer <input type="checkbox"/>	OEM/ODM <input type="checkbox"/>	Develop New Item <input type="checkbox"/>
	PACKING	Bulk Pack <input type="checkbox"/>	White Box+Sticker <input type="checkbox"/>	Gift Box <input type="checkbox"/>
	STANDARD	60Pcs/Ctn Measure: 50x41x35cm, G.W/N.W:5.2/4.2kgs		
	USE FOR	For Put Rodenticide, Also Can Be As The Protect Cover Of The Snap Traps ,To Protect The Pets And The Children For PCO Guys And House Use		

	NAME	Easy Rat Bait Station	ITEM NO.:	HC2120
	SIZE	26.5x17.5x11cm	MATERIAL	PP 500g
	ACCESSORY PARTS	Key <input type="checkbox"/>	Wall Parts <input type="checkbox"/>	Steel Bar <input type="checkbox"/>
	EXTRA SERVICE	Design For Customer <input type="checkbox"/>	OEM/ODM <input type="checkbox"/>	Develop New Item <input type="checkbox"/>
	PACKING	Bulk Pack <input type="checkbox"/>	White Box+Sticker <input type="checkbox"/>	Gift Box <input type="checkbox"/>
	STANDARD	20Pcs/Ctn,Measure:55x37x49cm, G.W/N.W: 11/10kgs		
	USE FOR	For Put Rodenticide, Also Can Be As The Protect Cover Of The Snap Traps ,To Protect The Pets And The Children For PCO Guys And House Use		

	NAME	Easy Mouse Bait Station	ITEM NO.:	HC2107
	SIZE	31x14.2x11.2cm	MATERIAL	Durable PP 435 g
	ACCESSORY PARTS	Key <input type="checkbox"/>	Wall Parts <input type="checkbox"/>	Steel Bar <input type="checkbox"/>
	EXTRA SERVICE	Design For Customer <input type="checkbox"/>	OEM/ODM <input type="checkbox"/>	Develop New Item <input type="checkbox"/>
	PACKING	Bulk Pack <input type="checkbox"/>	White Box+Sticker <input type="checkbox"/>	Gift Box <input type="checkbox"/>
	STANDARD	10Pcs/Ctn, Measure: 58x30.5x33CM, G.W/N.W:5.35/4.35kgs		
	USE FOR	For Put Rodenticide, Also Can Be As The Protect Cover Of The Snap Traps ,To Protect The Pets And The Children For PCO Guys And House Use		

	NAME	Easy Mouse Bait Station	ITEM NO.:	HC2112
	SIZE	13.4x9.7x3.2cm	MATERIAL	PP 55g
	ACCESSORY PARTS	Key <input type="checkbox"/>	Wall Parts <input type="checkbox"/>	Steel Bar <input type="checkbox"/>
	EXTRA SERVICE	Design For Customer <input type="checkbox"/>	OEM/ODM <input type="checkbox"/>	Develop New Item <input type="checkbox"/>
	PACKING	Bulk Pack <input type="checkbox"/>	White Box+Sticker <input type="checkbox"/>	Gift Box <input type="checkbox"/>
	STANDARD	144Pcs/Ctn,Measure: 44x44x35cm, G.W/N.W:9/8kgs		
	USE FOR	For Put Rodenticide, Also Can Be As The Protect Cover Of The Snap Traps ,To Protect The Pets And The Children For PCO Guys And House Use		

	NAME	Easy Mouse Bait Station	ITEM NO.:	HC2106
	SIZE	15x11.5x5.5cm	MATERIAL	PS 40g
	ACCESSORY PARTS	Key <input type="checkbox"/>	Wall Parts <input type="checkbox"/>	Steel Bar <input type="checkbox"/>
	EXTRA SERVICE	Design For Customer <input type="checkbox"/>	OEM/ODM <input type="checkbox"/>	Develop New Item <input type="checkbox"/>
	PACKING	Bulk Pack <input type="checkbox"/>	White Box+Sticker <input type="checkbox"/>	Gift Box <input type="checkbox"/>
	STANDARD	180Pcs/Ctn, Measure:41x47x32cm, G.W/N.W:8.2/7.2kgs		
	USE FOR	For Put Rodenticide, Also Can Be As The Protect Cover Of The Snap Traps ,To Protect The Pets And The Children For PCO Guys And House Use		

	NAME	Easy Mouse Bait Station With Trap	ITEM NO.:	HC2115
	SIZE	21.5x19x9.5cm	MATERIAL	PP 260g
	ACCESSORY PARTS	Key <input type="checkbox"/>	Wall Parts <input type="checkbox"/>	Steel Bar <input type="checkbox"/>
	EXTRA SERVICE	Design For Customer <input type="checkbox"/>	OEM/ODM <input type="checkbox"/>	Develop New Item <input type="checkbox"/>
	PACKING	Bulk Pack <input type="checkbox"/>	White Box+Sticker <input type="checkbox"/>	Gift Box <input type="checkbox"/>
	STANDARD	25Pcs/Ctn, Measure: 61.5x55x40.5cm, G.W/N.W:7.5/6.5kgs		
	USE FOR	For Put Rodenticide, Also Can Be As The Protect Cover Of The Snap Traps ,To Protect The Pets And The Children For PCO Guys And House Use		

	NAME	Steel Bait Station	ITEM NO.:	HC2117
	SIZE	40x12x11.5cm	MATERIAL	Steel 800g
	ACCESSORY PARTS	Key <input type="checkbox"/>	Wall Parts <input type="checkbox"/>	Steel Bar <input type="checkbox"/>
	EXTRA SERVICE	Design For Customer <input type="checkbox"/>	OEM/ODM <input type="checkbox"/>	Develop New Item <input type="checkbox"/>
	PACKING	Bulk Pack <input type="checkbox"/>	White Box+Sticker <input type="checkbox"/>	Gift Box <input type="checkbox"/>
	STANDARD	4Pcs/Ctn, Measure: 43x41x24cm, G.W/N.W: 4.2/3.2kgs		
	USE FOR	For Put Rodenticide, Also Can Be As The Protect Cover Of The Snap Traps ,To Protect The Pets And The Children For PCO Guys And House Use		

	NAME	Easy Mouse Bait Station	ITEM NO.:	HC2116
	SIZE	22.5x18.1x9.5CM	MATERIAL	PP 450g
	ACCESSORY PARTS	Key <input type="checkbox"/>	Wall Parts <input type="checkbox"/>	Steel Bar <input type="checkbox"/>
	EXTRA SERVICE	Design For Customer <input type="checkbox"/>	OEM/ODM <input type="checkbox"/>	Develop New Item <input type="checkbox"/>
	PACKING	Bulk Pack <input type="checkbox"/>	White Box+Sticker <input type="checkbox"/>	Gift Box <input type="checkbox"/>
	STANDARD	12Pcs/Ctn, Measure: 47x39x31cm, G.W/N.W:6.4/5.4kgs		
	USE FOR	For Put Rodenticide, Also Can Be As The Protect Cover Of The Snap Traps ,To Protect The Pets And The Children For PCO Guys And House Use		

	NAME	Easy Mouse Bait Station With Trap	ITEM NO.:	HC2119
	SIZE	15x11.5x6.5cm	MATERIAL	Durable PP 140g
	ACCESSORY PARTS	Key <input type="checkbox"/>	Wall Parts <input type="checkbox"/>	Steel Bar <input type="checkbox"/>
	EXTRA SERVICE	Design For Customer <input type="checkbox"/>	OEM/ODM <input type="checkbox"/>	Develop New Item <input type="checkbox"/>
	PACKING	Bulk Pack <input type="checkbox"/>	White Box+Sticker <input type="checkbox"/>	Gift Box <input type="checkbox"/>
	STANDARD	40Pcs/Ctn,Measure: 36.5x17x50cm, G.W/N.W.: 6.6/5.6kgs		
	USE FOR	For Put Rodenticide, Also Can Be As The Protect Cover Of The Snap Traps ,To Protect The Pets And The Children For PCO Guys And House Use		

	NAME	Electric Rodent Kill Box	ITEM NO.:	HC2125
	SIZE	16x8.3x4.2cm	MATERIAL	ABS 200g
	ACCESSORY PARTS	6V (battery AA*4)	TIME	Around 24 hours auto power-off
	EXTRA SERVICE	Design For Customer <input type="checkbox"/>	OEM/ODM <input type="checkbox"/>	Develop New Item <input type="checkbox"/>
	PACKING	Bulk Pack <input type="checkbox"/>	White Box+Sticker <input type="checkbox"/>	Gift Box <input type="checkbox"/>
	STANDARD	1Pcs/Box,30Boxes/Ctn, Measure: 54.5x28x21.5cm, G.W/N.W:7/6 kgs		
	USE FOR	Catching Mouse		





	NAME	Plastic Rat Snap Trap	ITEM NO.:	HC2201
	SIZE	14x7.5cm	MATERIAL	ABS 100g
	EXTRA SERVICE	Design For Customer <input type="checkbox"/>	OEM/ODM <input type="checkbox"/>	Develop New Item <input type="checkbox"/>
	PACKING	Bulk Pack <input type="checkbox"/>	Head Card <input type="checkbox"/>	Blister Card <input type="checkbox"/>
	STANDARD	80Pcs/Ctn, Measure:42X23X42cm, G.W/N.W:8.5/8kgs		
	USE FOR	Catching Mouse		

	NAME	Plastic Rat Snap Trap	ITEM NO.:	HC2208
	SIZE	12.5x5.7x7.0cm	MATERIAL	ABS
	EXTRA SERVICE	Design For Customer <input type="checkbox"/>	OEM/ODM <input type="checkbox"/>	Develop New Item <input type="checkbox"/>
	PACKING	Bulk Pack <input type="checkbox"/>	Head Card <input type="checkbox"/>	Blister Card <input type="checkbox"/>
	STANDARD			
	USE FOR	Catching Mouse		

	NAME	Plastic Rat Snap Trap	ITEM NO.:	HC2202
	SIZE	11.4x5cm	MATERIAL	ABS 50g
	EXTRA SERVICE	Design For Customer <input type="checkbox"/>	OEM/ODM <input type="checkbox"/>	Develop New Item <input type="checkbox"/>
	PACKING	Bulk Pack <input type="checkbox"/>	Head Card <input type="checkbox"/>	Blister Card <input type="checkbox"/>
	STANDARD	162Pcs/Ctn, Measure:40x37x30cm, G.W/N.W:9.1/8.1kgs		
	USE FOR	Catching Mouse		

	NAME	Plastic Rat Snap Trap	ITEM NO.:	HC2211
	SIZE	9.7x4.5x4.5cm	MATERIAL	ABS 30g
	EXTRA SERVICE	Design For Customer <input type="checkbox"/>	OEM/ODM <input type="checkbox"/>	Develop New Item <input type="checkbox"/>
	PACKING	Bulk Pack <input type="checkbox"/>	Head Card <input type="checkbox"/>	Blister Card <input type="checkbox"/>
	STANDARD	72Pcs/Ctn, Measure: 40x32x32cm, G.W/N.W:2.8/2.2kgs		
	USE FOR	Catching Mouse		

	NAME	Mini Plastic Rat Snap Trap	ITEM NO.:	HC2202S
	SIZE	9.7x4.7cm	MATERIAL	ABS 40g
	EXTRA SERVICE	Design For Customer <input type="checkbox"/>	OEM/ODM <input type="checkbox"/>	Develop New Item <input type="checkbox"/>
	PACKING	Bulk Pack <input type="checkbox"/>	Head Card <input type="checkbox"/>	Blister Card <input type="checkbox"/>
	STANDARD	200Pc/Bilster, Measure:41X37X22cm, G.W/N.W:8.6/8kgs		
	USE FOR	Catching Mouse		

	NAME	Plastic Rat Snap Trap	ITEM NO.:	HC2212
	SIZE	14.5x7.0x7.0cm	MATERIAL	ABS 70g
	EXTRA SERVICE	Design For Customer <input type="checkbox"/>	OEM/ODM <input type="checkbox"/>	Develop New Item <input type="checkbox"/>
	PACKING	Bulk Pack <input type="checkbox"/>	Head Card <input type="checkbox"/>	Blister Card <input type="checkbox"/>
	STANDARD	72Pcs/Ctn, Measure: 47x49x40cm, G.W/N.W:6/5kgs		
	USE FOR	Catching Mouse		

	NAME	Plastic Rat Snap Trap	ITEM NO.:	HC2205
	SIZE	10.5x4.7x5.5cm	MATERIAL	ABS 50g
	EXTRA SERVICE	Design For Customer <input type="checkbox"/>	OEM/ODM <input type="checkbox"/>	Develop New Item <input type="checkbox"/>
	PACKING	Bulk Pack <input type="checkbox"/>	Head Card <input type="checkbox"/>	Blister Card <input type="checkbox"/>
	STANDARD	24Pcs/Inner Box , 16Boxes/Ctn, Measure:56x43x40cm, G.W/N.W:20/19kgs		
	USE FOR	Catching Mouse		

	NAME	Rat Snap Trap	ITEM NO.:	HC2214
	SIZE	17.0x9.0cm	MATERIAL	Metal 190g
	EXTRA SERVICE	Design For Customer <input type="checkbox"/>	OEM/ODM <input type="checkbox"/>	Develop New Item <input type="checkbox"/>
	PACKING	Bulk Pack <input type="checkbox"/>	Head Card <input type="checkbox"/>	Blister Card <input type="checkbox"/>
	STANDARD	40Pcs/Ctn,Measure:47x32x28cm,G.W/N.W:8.4/7.4kgs		
	USE FOR	Catching Mouse		

	NAME	Plastic Rat Snap Trap	ITEM NO.:	HC 2206
	SIZE	14x7.5x7cm	MATERIAL	ABS 107g
	EXTRA SERVICE	Design For Customer <input type="checkbox"/>	OEM/ODM <input type="checkbox"/>	Develop New Item <input type="checkbox"/>
	PACKING	Bulk Pack <input type="checkbox"/>	Head Card <input type="checkbox"/>	Blister Card <input type="checkbox"/>
	STANDARD	100Pcs/Ctn, Measure: 50X37X34cm, G.W/N.W:12.7/11.5kgs		
	USE FOR	Catching Mouse		

	NAME	Wooded Mouse Snap Trap	ITEM NO.:	HC2215DS
	SIZE	9.8X4.8X0.65cm	MATERIAL	Wooden 30g
	EXTRA SERVICE	Design For Customer <input type="checkbox"/>	OEM/ODM <input type="checkbox"/>	Develop New Item <input type="checkbox"/>
	PACKING	Bulk Pack <input type="checkbox"/>	Head Card <input type="checkbox"/>	Blister Card <input type="checkbox"/>
	STANDARD	1Pc/Card,72Cards/Ctn,21x16x10cm,GW/NW:3.16/2.16kgs		
	USE FOR	Catching Mouse		





	NAME	Wooden Mouse Snap Trap	ITEM NO.:	HC2217
	SIZE	9.8x4.8x0.65cm	MATERIAL	Wooden 30g
	EXTRA SERVICE	Design For Customer <input type="checkbox"/>	OEM/ODM <input type="checkbox"/>	Develop New Item <input type="checkbox"/>
	PACKING	Bulk Pack <input type="checkbox"/>	Head Card <input type="checkbox"/>	Blister Card <input type="checkbox"/>
	STANDARD	1Pc/Card,72Cards/Ctn,21x16x10cm,GW/NW:3.16/2.16kgs		
	USE FOR	Catching Mouse		

	NAME	Mini Plastic Mouse Tunnel	ITEM NO.:	HC2216S
	SIZE	16.5x4.0x4.0cm	MATERIAL	PP 40g
	EXTRA SERVICE	Design For Customer <input type="checkbox"/>	OEM/ODM <input type="checkbox"/>	Develop New Item <input type="checkbox"/>
	PACKING	Bulk Pack <input type="checkbox"/>	Head Card <input type="checkbox"/>	Blister Card <input type="checkbox"/>
	STANDARD	80Pcs/Ctn,Measure:44x36x18cm,4.14/3.44kgs		
	USE FOR	Catching Mouse		

	NAME	Wooden Mouse Snap Trap	ITEM NO.:	HC2215DL
	SIZE	17.5x8.2x0.3cm	MATERIAL	Wooden 110g
	EXTRA SERVICE	Design For Customer <input type="checkbox"/>	OEM/ODM <input type="checkbox"/>	Develop New Item <input type="checkbox"/>
	PACKING	Bulk Pack <input type="checkbox"/>	Head Card <input type="checkbox"/>	Blister Card <input type="checkbox"/>
	STANDARD	1Pc/Card,72Cards/Ctn,Measure:73x28x37cm,G.W/N.W:10.4/9.4kgs		
	USE FOR	Catching Mouse		

	NAME	Plastic Mouse Tunnel	ITEM NO.:	HC2216
	SIZE	24.5x6.5x6.0cm	MATERIAL	PP 130g
	EXTRA SERVICE	Design For Customer <input type="checkbox"/>	OEM/ODM <input type="checkbox"/>	Develop New Item <input type="checkbox"/>
	PACKING	Bulk Pack <input type="checkbox"/>	Head Card <input type="checkbox"/>	Blister Card <input type="checkbox"/>
	STANDARD	24Pcs/Ctn,Measure: 52x30x21.5cm, G.W/N.W:3.9/3.1kgs		
	USE FOR	Catching Mouse		

	NAME	Wooden Mouse Snap Trap	ITEM NO.:	HC2217B
	SIZE	17.5x8.2x3cm	MATERIAL	Wooden 135g
	EXTRA SERVICE	Design For Customer <input type="checkbox"/>	OEM/ODM <input type="checkbox"/>	Develop New Item <input type="checkbox"/>
	PACKING	Bulk Pack <input type="checkbox"/>	Head Card <input type="checkbox"/>	Blister Card <input type="checkbox"/>
	STANDARD	1Pc/Card,72Cards/Ctn,Measure:73x28x37cm,G.W/N.W:11/10kgs		
	USE FOR	Catching Mouse		

	NAME	Plastic Mouse Tunnel	ITEM NO.:	HC2221
	SIZE	31.5x7.5x7.5cm	MATERIAL	ABS 191g
	EXTRA SERVICE	Design For Customer <input type="checkbox"/>	OEM/ODM <input type="checkbox"/>	Develop New Item <input type="checkbox"/>
	PACKING	Bulk Pack <input type="checkbox"/>	Head Card <input type="checkbox"/>	Blister Card <input type="checkbox"/>
	STANDARD	24Pcs/ctn,Measure:46.5x33x31.5cm,G.W/N.W:5.6/4.6kgs		
	USE FOR	Catching Mouse		

	NAME	Wooden Mouse Snap Trap	ITEM NO.:	HC2219
	SIZE	17.5x8.2x1.0cm	MATERIAL	Wooden 150g
	EXTRA SERVICE	Design For Customer <input type="checkbox"/>	OEM/ODM <input type="checkbox"/>	Develop New Item <input type="checkbox"/>
	PACKING	Bulk Pack <input type="checkbox"/>	Head Card <input type="checkbox"/>	Blister Card <input type="checkbox"/>
	STANDARD	1Pc/Card,72Cards/Ctn,Measure:73x28x37cm,G.W/N.W:12.5/11.5kgs		
	USE FOR	Catching Mouse		

	NAME	Plastic Mouse Trap	ITEM NO.:	HC2224S
	SIZE	17.5x6.2x6.4cm	MATERIAL	ABS 130g
	EXTRA SERVICE	Design For Customer <input type="checkbox"/>	OEM/ODM <input type="checkbox"/>	Develop New Item <input type="checkbox"/>
	PACKING	Bulk Pack <input type="checkbox"/>	Head Card <input type="checkbox"/>	Blister Card <input type="checkbox"/>
	STANDARD	48Pcs/Ctn,Measure:39x35.5x27cm,G.W/N.W:7.07/6.07kgs		
	USE FOR	Catching Mouse		

	NAME	Super Strong Rat Snap Trap	ITEM NO.:	HC2220
	SIZE	19X8.9X9cm	MATERIAL	ABS 220g
	EXTRA SERVICE	Design For Customer <input type="checkbox"/>	OEM/ODM <input type="checkbox"/>	Develop New Item <input type="checkbox"/>
	PACKING	Bulk Pack <input type="checkbox"/>	Head Card <input type="checkbox"/>	Blister Card <input type="checkbox"/>
	STANDARD	48Pcs/Ctn, Measure: 55x39.5x37.5cm, G.W/N.W:11.9/10.9kgs		
	USE FOR	Catching Mouse		

	NAME	Plastic Mouse Trap	ITEM NO.:	HC2224L
	SIZE	24x8x9.2cm	MATERIAL	ABS 261g
	EXTRA SERVICE	Design For Customer <input type="checkbox"/>	OEM/ODM <input type="checkbox"/>	Develop New Item <input type="checkbox"/>
	PACKING	Bulk Pack <input type="checkbox"/>	Head Card <input type="checkbox"/>	Blister Card <input type="checkbox"/>
	STANDARD	48Pcs/ctn,Measure:49.5x49.5x37.5cm,g.w/n.w:13.5/12.5kgs		
	USE FOR	Catching Mouse		





	NAME	Copper Foil Tape 1inch		ITEM NO.:	HC2903-1inch
	SIZE	1INCH X 66 FT		MATERIAL	Copper
	PACKING	Bulk Pack <input type="checkbox"/>	White Box+Sticker <input type="checkbox"/>	Gift Box <input type="checkbox"/>	Display Box <input type="checkbox"/>
	STANDARD				

	NAME	Copper Foil Tape 2inch		ITEM NO.:	HC2903-2inch
	SIZE	2INCH X 33 FT		MATERIAL	Copper
	PACKING	Bulk Pack <input type="checkbox"/>	White Box+Sticker <input type="checkbox"/>	Gift Box <input type="checkbox"/>	Display Box <input type="checkbox"/>
	STANDARD				





Copper Mesh Rat Mouse Mice Bat Control

A photograph showing three rolls of copper mesh on a teal background. One roll is standing upright, another is partially unrolled, and a third is lying flat, showing the fine texture of the mesh.

Rodent Control

	NAME	Cooper Mesh	ITEM NO.:	HC14004-20FT
	SIZE	4' X20ft	MATERIAL	Cooper 160g
	PACKING	Bulk Pack <input type="checkbox"/> White Box+Sticker <input type="checkbox"/>	Gift Box <input type="checkbox"/>	Display Box <input type="checkbox"/>
	STANDARD	90Pcs/Ctn, Measure: 45x45x47cm, G.W/N.W:15.92/14.92kgs		

	NAME	Cooper Mesh	ITEM NO.:	HC14004-30FT
	SIZE	4' X30ft	MATERIAL	Cooper 240g
	PACKING	Bulk Pack <input type="checkbox"/> White Box+Sticker <input type="checkbox"/>	Gift Box <input type="checkbox"/>	Display Box <input type="checkbox"/>
	STANDARD	60Pcs/Ctn, Measure: 45x45x47cm, G.W/N.W:15.94/14.94kgs		

	NAME	Cooper Mesh	ITEM NO.:	HC14004-50FT
	SIZE	4' X50ft	MATERIAL	Cooper 400g
	PACKING	Bulk Pack <input type="checkbox"/> White Box+Sticker <input type="checkbox"/>	Gift Box <input type="checkbox"/>	Display Box <input type="checkbox"/>
	STANDARD	36Pcs/Ctn, Measure: 45x45x47cm, G.W/N.W:15.88/14.88kgs		

	NAME	Cooper Mesh	ITEM NO.:	HC14004-100FT
	SIZE	4' X100ft	MATERIAL	Cooper 800g
	PACKING	Bulk Pack <input type="checkbox"/> White Box+Sticker <input type="checkbox"/>	Gift Box <input type="checkbox"/>	Display Box <input type="checkbox"/>
	STANDARD	16Pcs/Ctn, Measure: 45x45x47cm, G.W/N.W:14.16/13.16kgs		
	USE FOR	Pest Control - Easily Cut, Shaped And Installed. This Copper Mesh Can Be Used To Block Holes Of Any Shape And Size.Simply Cut a Piece Off And Either Secure Over The Gap Or Stuff The Hole Tightly .Using An Ordinary Scissors Or Knife. It Is Designed To Stuff All Kinds Of Openings To Stop Pests,Bugs,Mouses,Snails,Insects,Rodents And Other Similar Unwanted Animals. Works Great To Seal Weep Holes And Around Plumbing, Cracked Tubes, A/C, Vents And Other Places Where Rodents And Pests Enter.		

	NAME	EASY MOLE/VOLE /GOPHER TRAP	ITEM NO	HC2902
	SIZE	4" X5ft	MATERIAL	Stainless steel wool with polyfibres
	PACKING	Bulk Pack <input type="checkbox"/> White Box+Sticker <input type="checkbox"/>	Gift Box <input type="checkbox"/>	Display Box <input type="checkbox"/>
	USE FOR	Pest Control - Easily Cut, Shaped And Installed. This Copper Mesh Can Be Used To Block Holes Of Any Shape And Size.Simply Cut a Piece Off And Either Secure Over The Gap Or Stuff The Hole Tightly .Using An Ordinary Scissors Or Knife. It Is Designed To Stuff All Kinds Of Openings To Stop Pests,Bugs,Mouses,Snails,Insects,Rodents And Other Similar Unwanted Animals. Works Great To Seal Weep Holes And Around Plumbing, Cracked Tubes, a/c, Vents And Other Places Where Rodents And Pests Enter.		

	NAME	Mouse Glue Traps	ITEM NO.:	HC2301
	SIZE	14x22cm	UNIT QTY	3Pcs/Card
	GLUE WEIGHT			
	MATERIAL	400g/M ² Paper+8g Glue	61g	
	PACKING	Bulk Pack <input type="checkbox"/> white Box+Sticker <input type="checkbox"/>	Gift Box <input type="checkbox"/>	Display Box <input type="checkbox"/>
	STANDARD	3Pcs/Bag,160Bags/Ctn,Measure: 41x31.7x25.5cm, G.W/N.W:15.85/14.85kgs		
	USE FOR	Catch/Stick All Kinds Of Rat,Mouse and Other Similar Small Animals		

	NAME	Mouse Glue Traps	ITEM NO.:	HC2302
	SIZE	13X28CM	UNIT QTY	2Pcs/Card
	MATERIAL	400g/M ² Paper+10g Glue	87g	
	PACKING	Bulk Pack <input type="checkbox"/> white Box+Sticker <input type="checkbox"/>	Gift Box <input type="checkbox"/>	Display Box <input type="checkbox"/>
	STANDARD	2 Pcs/Bag,100Bags/Ctn, Measure: 44x29x15cm, G.W/N.W:18.4/17.4kgs		
	USE FOR	Catch/Stick All Kinds Of Rat,Mouse and Other Similar Small Animals		

	NAME	Mouse Glue Traps	ITEM NO.:	HC2303
	SIZE	16.5x21.5cm		
	MATERIAL	1000g/M ² Paper+25g Glue	132.5g	
	PACKING	Bulk Pack <input type="checkbox"/> white Box+Sticker <input type="checkbox"/>	Gift Box <input type="checkbox"/>	Display Box <input type="checkbox"/>
	STANDARD	100Pcs/Ctn, Measure: 44x35x23cm, G.W/N.W:13/12kgs		
	USE FOR	Catch/Stick All Kinds Of Rat,Mouse and Other Similar Small Animals		

	NAME	Easy Mouse Glue Traps	ITEM NO.:	HC2315
	SIZE	14x22cm		
	MATERIAL	400g/M ² Paper+15g Glue	25g	
	PACKING	Bulk Pack <input type="checkbox"/> white Box+Sticker <input type="checkbox"/>	Gift Box <input type="checkbox"/>	DISPLAY BOX <input type="checkbox"/>
	STANDARD			
	USE FOR	Catch/Stick All Kinds Of Rat,Mouse and Other Similar Small Animals		

	NAME	Pro Rodent Glue Board Trap	ITEM NO.:	HC2307
	SIZE	13.5x25cm		
	MATERIAL	PVC Tray+35g Glue	176g	
	PACKING	Bulk Pack <input type="checkbox"/> white Box+Sticker <input type="checkbox"/>	Gift Box <input type="checkbox"/>	Display Box <input type="checkbox"/>
	STANDARD	2Pcs/Box,48Boxes/Ctn, Measure: 53x30x34cm,G.W/N.W:18/17kgs		
	USE FOR	Catch/Stick All Kinds Of Rat,Mouse and Other Similar Small Animals		





	NAME	Pro Rodent Glue Board Trap	ITEM NO.:	HC2308	
	SIZE	17X22cm			
	MATERIAL	1200g/M ² Paper+35g Glue 265 g			
	PACKING	Bulk Pack <input type="checkbox"/>	white Box+Sticker <input type="checkbox"/>	Gift Box <input type="checkbox"/>	Display Box <input type="checkbox"/>
	STANDARD	100Pcs/Ctn, Measure: 45x36x24cm, G.W/N.W:27.5/26.5kgs			
	USE FOR	Catch/Stick All Kinds Of Rat,Mouse and Other Similar Small Animals			

	NAME	PRO RODENT GLUE BOARD TRAP	ITEM NO.:	HC2309	
	SIZE	17X22CM			
	MATERIAL	1200g/M ² Paper+40g Glue 140g			
	PACKING	Bulk Pack <input type="checkbox"/>	white Box+Sticker <input type="checkbox"/>	Gift Box <input type="checkbox"/>	Display Box <input type="checkbox"/>
	STANDARD	100Pcs/Ctn, Measure: 45x36x24cm, G.W/N.W:15/14kgs			
	USE FOR	Catch/Stick All Kinds Of Rat,Mouse and Other Similar Small Animals			

	NAME	Pro Rodent Glue Board Trap	ITEM NO.:	HC2310	
	SIZE	17x22cm			
	MATERIAL	1000g/M ² Paper+20g Glue 140g			
	PACKING	Bulk Pack <input type="checkbox"/>	white Box+Sticker <input type="checkbox"/>	Gift Box <input type="checkbox"/>	Display Box <input type="checkbox"/>
	STANDARD	100Pcs/Ctn, Measure: 45x36x24cm, G.W/N.W:15/14kgs			
	USE FOR	Catch/Stick All Kinds Of Rat,Mouse and Other Similar Small Animals			

	NAME	Pro Rodent Glue Board Trap	ITEM NO.:	HC2311	
	SIZE	17x22cm			
	MATERIAL	1200g/M ² Paper+25g Glue 140g			
	PACKING	Bulk Pack <input type="checkbox"/>	white Box+Sticker <input type="checkbox"/>	Gift Box <input type="checkbox"/>	Display Box <input type="checkbox"/>
	STANDARD	100Pcs/Ctn, Measure: 45x36x24cm, G.W/N.W:15/140kgs			
	USE FOR	Catch/Stick All Kinds Of Rat,Mouse and Other Similar Small Animals			

	NAME	Pro PCO Glue Trap	ITEM NO.:	HC2312	
	SIZE	17x22cm			
	MATERIAL	1200g/M ² Paper+45g Glue 140g			
	PACKING	Bulk Pack <input type="checkbox"/>	white Box+Sticker <input type="checkbox"/>	Gift Box <input type="checkbox"/>	Display Box <input type="checkbox"/>
	STANDARD	100Pcs/Ctn, Measure: 45x36x24cm, G.W/N.W:15/14kgs			
	USE FOR	Catch/Stick All Kinds Of Rat,Mouse and Other Similar Small Animals			

	NAME	PCO Glue Trapp Protect Cover	ITEM NO.:	HC230001-P	
	SIZE	22x10x10cm			
	MATERIAL	PP 392g			
	PACKING	Bulk Pack <input type="checkbox"/>	white Box+Sticker <input type="checkbox"/>	Gift Box <input type="checkbox"/>	Display Box <input type="checkbox"/>
	STANDARD	20Pcs/Ctn, Measure: 51.5x41.5x25cm, G.W/N.W:9.1/8.1kgs			
	USE FOR	Protect The Glue Traps And Also Make The Glue Trap Become A Tunnel			

	NAME	PCO Glue Trapp Protect Cover	ITEM NO.:	HC230001-PL	
	SIZE	33x10x10cm			
	MATERIAL	PP 588g			
	PACKING	Bulk Pack <input type="checkbox"/>	white Box+Sticker <input type="checkbox"/>	Gift Box <input type="checkbox"/>	Display Box <input type="checkbox"/>
	STANDARD	16Pcs/Ctn, Measure: 51.5x41.5x25cm, G.W/N.W:9.1/8.1kgs			
	USE FOR	Protect The Glue Traps And Also Make The Glue Trap Become A Tunnel			

	NAME	PCO Glue Trapp Protect Cover	ITEM NO.:	HC2108-A	
	SIZE	23x10x10cm			
	MATERIAL	GALVANIZED SHEET 500g			
	PACKING	Bulk Pack <input type="checkbox"/>	white Box+Sticker <input type="checkbox"/>	Gift Box <input type="checkbox"/>	Display Box <input type="checkbox"/>
	STANDARD	30Pcs/Ctn, Measure: 51.5x41.5x25cm, G.W/N.W:9.1/8.1kgs			
	USE FOR	Protect The Glue Traps And Also Make The Glue Trap Become A Tunnel			

	NAME	PCO Glue Trapp Protect Cover	ITEM NO.:	HC23001-DS	
	SIZE	22x10x10cm			
	MATERIAL	GALVANIZED SHEET 415.5g			
	PACKING	Bulk Pack <input type="checkbox"/>	white Box+Sticker <input type="checkbox"/>	Gift Box <input type="checkbox"/>	Display Box <input type="checkbox"/>
	STANDARD	48Pcs/Ctn, Measure: 51.5x41.5x25cm, G.W/N.W:9.1/8.1kgs			
	USE FOR	Protect The Glue Traps And Also Make The Glue Trap Become A Tunnel			

	NAME	PCO Glue Trapp Protect Cover	ITEM NO.:	HC23001-S	
	SIZE	22.2x11.6x10cm			
	MATERIAL	GALVANIZED SHEET 356g			
	PACKING	Bulk Pack <input type="checkbox"/>	white Box+Sticker <input type="checkbox"/>	Gift Box <input type="checkbox"/>	Display Box <input type="checkbox"/>
	STANDARD	50Pcs/Ctn, Measure: 51.5x41.5x25cm, G.W/N.W:9.1/8.1kgs			
	USE FOR	Protect The Glue Traps And Also Make The Glue Trap Become A Tunnel			





RODENT CONTROL





Rodent Control

	NAME	Easy Mole/Vole /Gopher Trap			ITEM NO.:	HC2401	
	MATERIAL	Steel				145.5g	
	SIZE	19x11x9cm					
	SURFACE	Galvanizing <input type="checkbox"/>	Powder Coating <input type="checkbox"/>	Electrophoretic Paint <input type="checkbox"/>			
	COLOR	Sliver <input type="checkbox"/>	Black <input type="checkbox"/>	Golden <input type="checkbox"/>	Green <input type="checkbox"/>		
	PACKING	Bulk Pack <input type="checkbox"/>	White Box+Sticker <input type="checkbox"/>	Gift Box <input type="checkbox"/>	Head Card <input type="checkbox"/>		
	STANDARD	50Pcs/Ctn, Measure: 48x35x33cm, G.W/N.W: 8/7kgs					
	USE FOR	Catch The Wild Vole, Gopher, Mole And Similar Animals					

	NAME	Easy Mole/Vole /Gopher Trap			ITEM NO.:	HC2407	
	MATERIAL	Steel				150g	
	SIZE	17x9x7cm					
	SURFACE	Galvanizing <input type="checkbox"/>	Powder Coating <input type="checkbox"/>	Electrophoretic Paint <input type="checkbox"/>			
	COLOR	Sliver <input type="checkbox"/>	Black <input type="checkbox"/>	Golden <input type="checkbox"/>	Green <input type="checkbox"/>		
	PACKING	Bulk Pack <input type="checkbox"/>	White Box+Sticker <input type="checkbox"/>	Gift Box <input type="checkbox"/>	Head Card <input type="checkbox"/>		
	STANDARD	50Pcs/Ctn, Measure: 48x35x33cm, G.W/N.W: 8.5/7.5kgs					
	USE FOR	Catch The Wild Vole, Gopher, Mole And Similar Animals					

	NAME	Easy Mole/Vole /Gopher Trap			ITEM NO.:	HC2403	
	MATERIAL	Steel				240g	
	SIZE	14x12x6cm					
	SURFACE	Galvanizing <input type="checkbox"/>	Powder Coating <input type="checkbox"/>	Electrophoretic Paint <input type="checkbox"/>			
	COLOR	Sliver <input type="checkbox"/>	Black <input type="checkbox"/>	Golden <input type="checkbox"/>	Green <input type="checkbox"/>		
	PACKING	Bulk Pack <input type="checkbox"/>	White Box+Sticker <input type="checkbox"/>	Gift Box <input type="checkbox"/>	Head Card <input type="checkbox"/>		
	STANDARD	50Pcs/Ctn, Measure: 43x36x23.5cm, G.W/N.W: 13/12kgs					
	USE FOR	Catch The Wild Vole, Gopher, Mole And Similar Animals					

	NAME	Easy Mole/Vole /Gopher Trap			ITEM NO.:	HC2408	
	MATERIAL	Steel				73g	
	SIZE	17x9x7cm					
	SURFACE	Galvanizing <input type="checkbox"/>	Powder Coating <input type="checkbox"/>	Electrophoretic Paint <input type="checkbox"/>			
	COLOR	Sliver <input type="checkbox"/>	Black <input type="checkbox"/>	Golden <input type="checkbox"/>	Green <input type="checkbox"/>		
	PACKING	Bulk Pack <input type="checkbox"/>	White Box+Sticker <input type="checkbox"/>	Gift Box <input type="checkbox"/>	Head Card <input type="checkbox"/>		
	STANDARD	180Pcs/Ctn, Measure: 43x33.5x24cm, G.W/N.W:14.14/13.14kgs					
	USE FOR	Catch The Wild Vole, Gopher, Mole And Similar Animals					

	NAME	Easy Mole/Vole /Gopher Trap			ITEM NO.:	HC2404	
	MATERIAL	Steel				290g	
	SIZE	21x12x15cm					
	SURFACE	Galvanizing <input type="checkbox"/>	Powder Coating <input type="checkbox"/>	Electrophoretic Paint <input type="checkbox"/>			
	COLOR	Sliver <input type="checkbox"/>	Black <input type="checkbox"/>	Golden <input type="checkbox"/>	Green <input type="checkbox"/>		
	PACKING	Bulk Pack <input type="checkbox"/>	White Box+Sticker <input type="checkbox"/>	Gift Box <input type="checkbox"/>	Head Card <input type="checkbox"/>		
	STANDARD	40Pcs/Ctn, Measure: 41x32x38cm, G.W/N.W: 12.6/11.6kgs					
	USE FOR	Catch The Wild Vole, Gopher, Mole And Similar Animals					

	NAME	Easy Mole/Vole /Gopher Trap			ITEM NO.:	HC2409	
	MATERIAL	Steel				82g	
	SIZE	20x8x6cm					
	SURFACE	Galvanizing <input type="checkbox"/>	Powder Coating <input type="checkbox"/>	Electrophoretic Paint <input type="checkbox"/>			
	COLOR	Sliver <input type="checkbox"/>	Black <input type="checkbox"/>	Golden <input type="checkbox"/>	Green <input type="checkbox"/>		
	PACKING	Bulk Pack <input type="checkbox"/>	White Box+Sticker <input type="checkbox"/>	Gift Box <input type="checkbox"/>	Head Card <input type="checkbox"/>		
	STANDARD	100Pcs/Ctn, Measure: 36x26x21cm, G.W/N.W:9.2/8.2kgs					
	USE FOR	Catch The Wild Vole, Gopher, Mole And Similar Animals					

	NAME	Easy Mole/Vole /Gopher Trap			ITEM NO.:	HC2405	
	MATERIAL	Steel				350g	
	SIZE	21x12x15cm					
	SURFACE	Galvanizing <input type="checkbox"/>	Powder Coating <input type="checkbox"/>	Electrophoretic Paint <input type="checkbox"/>			
	COLOR	Sliver <input type="checkbox"/>	Black <input type="checkbox"/>	Golden <input type="checkbox"/>	Green <input type="checkbox"/>		
	PACKING	Bulk Pack <input type="checkbox"/>	White Box+Sticker <input type="checkbox"/>	Gift Box <input type="checkbox"/>	Head Card <input type="checkbox"/>		
	STANDARD	20Pcs/Ctn, Measure: 39x25x26 cm, G.W/N.W: 7.7/7kgs					
	USE FOR	Catch The Wild Vole, Gopher, Mole And Similar Animals					

	NAME	Easy Mole/Vole /Gopher Trap			ITEM NO.:	HC2410	
	MATERIAL	Steel				57g	
	SIZE	14x12x6cm					
	SURFACE	Galvanizing <input type="checkbox"/>	Powder Coating <input type="checkbox"/>	Electrophoretic Paint <input type="checkbox"/>			
	COLOR	Sliver <input type="checkbox"/>	Black <input type="checkbox"/>	Golden <input type="checkbox"/>	Green <input type="checkbox"/>		
	PACKING	Bulk Pack <input type="checkbox"/>	White Box+Sticker <input type="checkbox"/>	Gift Box <input type="checkbox"/>	Head Card <input type="checkbox"/>		
	STANDARD	100Pcs/Ctn, Measure: 36x26x21cm, G.W/N.W:6.7/5.7kgs					
	USE FOR	Catch The Wild Vole, Gopher, Mole And Similar Animals					

	NAME	Easy Mole/Vole /Gopher Trap			ITEM NO.:	HC2406	
	MATERIAL	Steel				125g	
	SIZE	15x9x7.5cm					
	SURFACE	Galvanizing <input type="checkbox"/>	Powder Coating <input type="checkbox"/>	Electrophoretic Paint <input type="checkbox"/>			
	COLOR	Sliver <input type="checkbox"/>	Black <input type="checkbox"/>	Golden <input type="checkbox"/>	Green <input type="checkbox"/>		
	PACKING	Bulk Pack <input type="checkbox"/>	White Box+Sticker <input type="checkbox"/>	Gift Box <input type="checkbox"/>	Head Card <input type="checkbox"/>		
	STANDARD	25Pcs/Ctn, Measure: 41.5x35x18cm, G.W/N.W: 3.8/3.2kgs					
	USE FOR	Catch The Wild Vole, Gopher, Mole And Similar Animals					

	NAME	Easy Mole/Vole /Gopher Trap			ITEM NO.:	HC2411	
	MATERIAL	Steel				76g	
	SIZE	21x12x15cm					
	SURFACE	Galvanizing <input type="checkbox"/>	Powder Coating <input type="checkbox"/>	Electrophoretic Paint <input type="checkbox"/>			
	COLOR	Sliver <input type="checkbox"/>	Black <input type="checkbox"/>	Golden <input type="checkbox"/>	Green <input type="checkbox"/>		
	PACKING	Bulk Pack <input type="checkbox"/>	White Box+Sticker <input type="checkbox"/>	Gift Box <input type="checkbox"/>	Head Card <input type="checkbox"/>		
	STANDARD	100Pcs/Ctn, Measure: 36x26x21cm, G.W/N.W:8.6/7.6kgs					
	USE FOR	Catch The Wild Vole, Gopher, Mole And Similar Animals					





Rodent Control

	NAME	Easy Mole/Vole /Gopher Trap		ITEM NO.:	HC2416
	MATERIAL	Steel	1250g	SIZE	30x15x20cm
	EXTRA SERVICE	OEM/ODM <input type="checkbox"/>	Design For Customer <input type="checkbox"/>	Develop New Item <input type="checkbox"/>	
	SURFACE	Galvanizing <input type="checkbox"/>	Powder Coating <input type="checkbox"/>	Electrophoretic Paint <input type="checkbox"/>	
	COLOR	Sliver <input type="checkbox"/>	Black <input type="checkbox"/>	Golden <input type="checkbox"/>	Green <input type="checkbox"/>
	PACKING	Bulk Pack <input type="checkbox"/>	White Box+Sticker <input type="checkbox"/>	Gift Box <input type="checkbox"/>	Head Card <input type="checkbox"/>
	STANDARD	1Pc/Box, 12Pcs/Ctn, Measure: 46.5x31.5x62.5cm, G.W/N.W:15/14kgs			
	USE FOR	Catch The Wild Vole, Gopher, Mole And Similar Animals			

	NAME	Easy Mole/Vole /Gopher Trap		ITEM NO.:	HC2418
	MATERIAL	Steel	1070g	SIZE	30X15X20CM
	EXTRA SERVICE	OEM/ODM <input type="checkbox"/>	Design For Customer <input type="checkbox"/>	Develop New Item <input type="checkbox"/>	
	SURFACE	Galvanizing <input type="checkbox"/>	Powder Coating <input type="checkbox"/>	Electrophoretic Paint <input type="checkbox"/>	
	COLOR	Sliver <input type="checkbox"/>	Black <input type="checkbox"/>	Golden <input type="checkbox"/>	Green <input type="checkbox"/>
	PACKING	Bulk Pack <input type="checkbox"/>	white Box+Sticker <input type="checkbox"/>	Gift Box <input type="checkbox"/>	Head Card <input type="checkbox"/>
	STANDARD	1Pc/Box, 12Pcs/Ctn, Measure: 46.5X31.5X62.5cm, G.W/N.W:15/14kgs			
	USE FOR	Catch The Wild Vole, Gopher, Mole And Similar Animals			

	NAME	Easy Mole/Vole /Gopher Trap		ITEM NO.:	HC2416B
	MATERIAL	Steel	1250g	SIZE	30x15x20cm
	EXTRA SERVICE	OEM/ODM <input type="checkbox"/>	Design For Customer <input type="checkbox"/>	Develop New Item <input type="checkbox"/>	
	SURFACE	Galvanizing <input type="checkbox"/>	Powder Coating <input type="checkbox"/>	Electrophoretic Paint <input type="checkbox"/>	
	COLOR	Sliver <input type="checkbox"/>	Black <input type="checkbox"/>	Golden <input type="checkbox"/>	Green <input type="checkbox"/>
	PACKING	Bulk Pack <input type="checkbox"/>	White Box+Sticker <input type="checkbox"/>	Gift Box <input type="checkbox"/>	Head Card <input type="checkbox"/>
	STANDARD	1Pc/Box, 12Pcs/Ctn, Measure: 46.5x31.5x62.5cm, G.W/N.W:15/14kgs			
	USE FOR	Catch The Wild Vole, Gopher, Mole And Similar Animals			

	NAME	Easy Mole/Vole /Gopher Trap		ITEM NO.:	HC2418S
	MATERIAL	Steel	1200g	SIZE	30X15X20CM
	EXTRA SERVICE	OEM/ODM <input type="checkbox"/>	Design For Customer <input type="checkbox"/>	Develop New Item <input type="checkbox"/>	
	SURFACE	Galvanizing <input type="checkbox"/>	Powder Coating <input type="checkbox"/>	Electrophoretic Paint <input type="checkbox"/>	
	COLOR	Sliver <input type="checkbox"/>	Black <input type="checkbox"/>	Golden <input type="checkbox"/>	Green <input type="checkbox"/>
	PACKING	Bulk Pack <input type="checkbox"/>	White Box+Sticker <input type="checkbox"/>	Gift Box <input type="checkbox"/>	Head Card <input type="checkbox"/>
	STANDARD	1Pc/Box, 12Pcs/Ctn, Measure: 46.5X31.5X62.5cm, G.W/N.W:16/15kgs			
	USE FOR	Catch The Wild Vole, Gopher, Mole And Similar Animals			

	NAME	Easy Mole/Vole /Gopher Trap		ITEM NO.:	HC2417
	MATERIAL	Steel	1190g	SIZE	30x15x20cm
	EXTRA SERVICE	OEM/ODM <input type="checkbox"/>	Design For Customer <input type="checkbox"/>	Develop New Item <input type="checkbox"/>	
	SURFACE	Galvanizing <input type="checkbox"/>	Powder Coating <input type="checkbox"/>	Electrophoretic Paint <input type="checkbox"/>	
	COLOR	Sliver <input type="checkbox"/>	Black <input type="checkbox"/>	Golden <input type="checkbox"/>	Green <input type="checkbox"/>
	PACKING	Bulk Pack <input type="checkbox"/>	White Box+Sticker <input type="checkbox"/>	Gift Box <input type="checkbox"/>	Head Card <input type="checkbox"/>
	STANDARD	1Pc/Box, 12Pcs/Ctn, Measure: 46.5x31.5x62.5cm, G.W/N.W:16/15kgs			
	USE FOR	Catch The Wild Vole, Gopher, Mole And Similar Animals			

	NAME	Easy Mole/Vole /Gopher Trap		ITEM NO.:	HC2415
	MATERIAL	PP+Steel		SIZE	116g
	EXTRA SERVICE	OEM/ODM <input type="checkbox"/>	Design For Customer <input type="checkbox"/>	Develop New Item <input type="checkbox"/>	
	COLOR	Sliver <input type="checkbox"/>	Black <input type="checkbox"/>	Golden <input type="checkbox"/>	Green <input type="checkbox"/>
	PACKING	Bulk Pack <input type="checkbox"/>	White Box+Sticker <input type="checkbox"/>	Gift Box <input type="checkbox"/>	Head Card <input type="checkbox"/>
	STANDARD	100Pcs/Ctn, Measure:62x24x32.5cm, G.W/N.W:12.6/11.6kgs			
	USE FOR	Catch The Wild Vole, Gopher, Mole And Similar Animals			

	NAME	Easy Mole/Vole /Gopher Trap		ITEM NO.:	HC2417S
	MATERIAL	Steel	1190g	SIZE	30x15x20cm
	EXTRA SERVICE	OEM/ODM <input type="checkbox"/>	Design For Customer <input type="checkbox"/>	Develop New Item <input type="checkbox"/>	
	SURFACE	Galvanizing <input type="checkbox"/>	Powder Coating <input type="checkbox"/>	Electrophoretic Paint <input type="checkbox"/>	
	COLOR	Sliver <input type="checkbox"/>	Black <input type="checkbox"/>	Golden <input type="checkbox"/>	Green <input type="checkbox"/>
	PACKING	Bulk Pack <input type="checkbox"/>	white Box+Sticker <input type="checkbox"/>	Gift Box <input type="checkbox"/>	Head Card <input type="checkbox"/>
	STANDARD	1Pc/Box, 12Pcs/Ctn, Measure: 46.5x31.5x62.5cm, G.W/N.W:/16/15kgs			
	USE FOR	Catch The Wild Vole, Gopher, Mole And Similar Animals			

	NAME	Easy Mole/Vole /Gopher Trap		ITEM NO.:	HC2415S
	MATERIAL	PP+Steel		SIZE	108g
	EXTRA SERVICE	OEM/ODM <input type="checkbox"/>	Design For Customer <input type="checkbox"/>	Develop New Item <input type="checkbox"/>	
	COLOR	Sliver <input type="checkbox"/>	Black <input type="checkbox"/>	Golden <input type="checkbox"/>	Green <input type="checkbox"/>
	PACKING	Bulk Pack <input type="checkbox"/>	white Box+Sticker <input type="checkbox"/>	Gift Box <input type="checkbox"/>	Head Card <input type="checkbox"/>
	STANDARD	100Pcs/Ctn, Measure: 52x52x27 cm, G.W/N.W:			
	USE FOR	Catch The Wild Vole, Gopher, Mole And Similar Animals			

	NAME	Easy Mole/Vole /Gopher Trap		ITEM NO.:	HC2420
	MATERIAL	Steel		SIZE	40x13x4cm
	EXTRA SERVICE	OEM/ODM <input type="checkbox"/>	Design For Customer <input type="checkbox"/>	Develop New Item <input type="checkbox"/>	
	SURFACE	Galvanizing <input type="checkbox"/>	Powder Coating <input type="checkbox"/>	Electrophoretic Paint <input type="checkbox"/>	
	COLOR	Sliver <input type="checkbox"/>	Black <input type="checkbox"/>	Golden <input type="checkbox"/>	Green <input type="checkbox"/>
	PACKING	Bulk Pack <input type="checkbox"/>	White Box+Sticker <input type="checkbox"/>	Gift Box <input type="checkbox"/>	Head Card <input type="checkbox"/>
	STANDARD				
	USE FOR	Catch The Wild Vole, Gopher, Mole And Similar Animals			

	NAME	Easy Mole/Vole /Gopher Trap		ITEM NO.:	HC2420S
	MATERIAL	Steel		SIZE	40x13x4cm
	EXTRA SERVICE	OEM/ODM <input type="checkbox"/>	Design For Customer <input type="checkbox"/>	Develop New Item <input type="checkbox"/>	
	SURFACE	Galvanizing <input type="checkbox"/>	Powder Coating <input type="checkbox"/>	Electrophoretic Paint <input type="checkbox"/>	
	COLOR	Sliver <input type="checkbox"/>	Black <input type="checkbox"/>	Golden <input type="checkbox"/>	Green <input type="checkbox"/>
	PACKING	Bulk Pack <input type="checkbox"/>	White Box+Sticker <input type="checkbox"/>	Gift Box <input type="checkbox"/>	Head Card <input type="checkbox"/>
	STANDARD				
	USE FOR	Catch The Wild Vole, Gopher, Mole And Similar Animals			



104.5mm



400mm

170mm



名称	视窗连续捕鼠器 (增高款)	型号	2501P	颜色	银色
材质	镀锌板	尺寸	400x170x104.5	包装	12个/箱
优势	此款连续捕鼠器经过改良，箱体加高·洞口加大，可以捕捉大小老鼠，更有效率				

4.6cm



16.2cm

HC2501L

6cm



16.2cm

HC2501D

10.4cm





17cm

HC2501P

Rodent Control

	NAME	Pro Multi Catch Mousetrap	ITEM NO.:	HC2501L	
	MATERIAL	Galvanized Sheet 560g	THICKNESS	0.4MM	
	SIZE	26.2x16.2x6cm			
	SURFACE	Galvanizing <input type="checkbox"/>	Powder Coating <input type="checkbox"/>	Electrophoretic Paint <input type="checkbox"/>	
	COLOR	Sliver <input type="checkbox"/>	Black <input type="checkbox"/>	Golden <input type="checkbox"/>	Green <input type="checkbox"/>
	PACKING	Bulk Pack <input type="checkbox"/>	White Box+Sticker <input type="checkbox"/>	Gift Box <input type="checkbox"/>	Head Card <input type="checkbox"/>
	STANDARD	20Pcs/Ctn, Measure: 54x33x33cm, G.W/N.W: 12.2/11.2kgs			
	USE FOR	Catch Mouse			

	NAME	Pro Multi Catch Mousetrap	ITEM NO.:	HC2502	
	MATERIAL	Galvanized Sheet 580g	THICKNESS	0.4MM	
	SIZE	26.2x16.2x6cm			
	SURFACE	Galvanizing <input type="checkbox"/>	Powder Coating <input type="checkbox"/>	Electrophoretic Paint <input type="checkbox"/>	
	COLOR	Sliver <input type="checkbox"/>	Black <input type="checkbox"/>	Golden <input type="checkbox"/>	Green <input type="checkbox"/>
	PACKING	Bulk Pack <input type="checkbox"/>	White Box+Sticker <input type="checkbox"/>	Gift Box <input type="checkbox"/>	Head Card <input type="checkbox"/>
	STANDARD	20Pcs/Ctn, Measure: 54x33x33cm, G.W/N.W: 12.6/11.6kgs			
	USE FOR	Catch Mouse			

	NAME	Pro Multi Catch Mousetrap	ITEM NO.:	HC2504	
	MATERIAL	Galvanized Sheet 457g	THICKNESS	0.4MM	
	SIZE	26.5x17x4.7cm			
	SURFACE	Galvanizing <input type="checkbox"/>	Powder Coating <input type="checkbox"/>	Electrophoretic Paint <input type="checkbox"/>	
	COLOR	Sliver <input type="checkbox"/>	Black <input type="checkbox"/>	Golden <input type="checkbox"/>	Green <input type="checkbox"/>
	PACKING	Bulk Pack <input type="checkbox"/>	White Box+Sticker <input type="checkbox"/>	Gift Box <input type="checkbox"/>	Head Card <input type="checkbox"/>
	STANDARD	20pcs/CTN, Measure: 55x36x26.5cm, G.W/N.W: 10.2/9.2kgs			
	USE FOR	Catch Mouse			

	NAME	Pro Multi Catch Rattrap	ITEM NO.:	HC2501D	
	MATERIAL	Galvanized Sheet 900g	THICKNESS	0.4MM	
	SIZE	36.3x16.1x6.1cm			
	SURFACE	Galvanizing <input type="checkbox"/>	Powder Coating <input type="checkbox"/>	Electrophoretic Paint <input type="checkbox"/>	
	COLOR	Sliver <input type="checkbox"/>	Black <input type="checkbox"/>	Golden <input type="checkbox"/>	Green <input type="checkbox"/>
	PACKING	Bulk Pack <input type="checkbox"/>	White Box+Sticker <input type="checkbox"/>	Gift Box <input type="checkbox"/>	Head Card <input type="checkbox"/>
	STANDARD	12Pcs/Ctn, Measure: 45.5X34.5X38CM, G.W/N.W:11.8/10.8kgs			
	USE FOR	Catch Mouse			

	NAME	Pro Multi Catch Mousetrap	ITEM NO.:	HC2501P	
	MATERIAL	Galvanized Sheet 1900g	THICKNESS	0.4MM	
	SIZE	400x170x104.5mm			
	SURFACE	Galvanizing <input type="checkbox"/>	Powder Coating <input type="checkbox"/>	Electrophoretic Paint <input type="checkbox"/>	
	COLOR	Sliver <input type="checkbox"/>	Black <input type="checkbox"/>	Golden <input type="checkbox"/>	Green <input type="checkbox"/>
	PACKING	Bulk Pack <input type="checkbox"/>	White Box+Sticker <input type="checkbox"/>	Gift Box <input type="checkbox"/>	Head Card <input type="checkbox"/>
	STANDARD	12Pcs/Ctn, Measure: 56x43x50cm, G.W/N.W: 12/11kgs			
	USE FOR	Catch Mouse			

	NAME	Multi Catch Mousetrap	ITEM NO.:	HC2506	
	MATERIAL	Galvanized Sheet 1230g	THICKNESS	0.4MM	
	SIZE	21.3x20.3x14cm			
	SURFACE	Galvanizing <input type="checkbox"/>	Powder Coating <input type="checkbox"/>	Electrophoretic Paint <input type="checkbox"/>	
	COLOR	Sliver <input type="checkbox"/>	Black <input type="checkbox"/>	Golden <input type="checkbox"/>	Green <input type="checkbox"/>
	PACKING	Bulk Pack <input type="checkbox"/>	White Box+Sticker <input type="checkbox"/>	Gift Box <input type="checkbox"/>	Head Card <input type="checkbox"/>
	STANDARD	1Pc/Box,4Boxes/Ctn, Measure:52x44x17cm, G.W/N.W:7/6kgs			
	USE FOR	Catch Mouse			

	NAME	Japan Spring Rat/Mouse Trap Cage	ITEM NO.:	HC2601	
	MATERIAL	Steel Wire	WIRE DIA	MESH SIZE	
	SIZE	B:33x18x13cm, Wire Dia: 2.0mm ,960g M:22.5x14.5x10cm, Wire Dia: 1.6mm ,330g			
	SURFACE	Galvanizing <input type="checkbox"/>	Powder Coating <input type="checkbox"/>	Electrophoretic Paint <input type="checkbox"/>	
	COLOR	Sliver <input type="checkbox"/>	Black <input type="checkbox"/>	Golden <input type="checkbox"/>	Green <input type="checkbox"/>
	PACKING	Bulk Pack <input type="checkbox"/>	White Box+Sticker <input type="checkbox"/>	Gift Box <input type="checkbox"/>	Head Card <input type="checkbox"/>
	STANDARD	B:16Pcs/Ctn, Measure: 70x39x55cm, G.W/N.W:16.36/15.36kgs ; M:40pcs/Ctn, Measure: 76.5x46.5x45cm, G.W/N.W:14.2/13.2kgs			
	USE FOR	Catch Mouse			

	NAME	Top Enter Rat/Mouse Trap Cage	ITEM NO.:	HC2602	
	MATERIAL	Steel Wire	MESH SIZE	1/4"	
	SIZE	B: 31x16.5x15.5cm,1.6mm <input type="checkbox"/> 0.8kg M: 21x14.5x8.5cm,0.6mm <input type="checkbox"/> 0.4kg			
	SURFACE	Galvanizing <input type="checkbox"/>	Powder Coating <input type="checkbox"/>	Electrophoretic Paint <input type="checkbox"/>	
	COLOR	Sliver <input type="checkbox"/>	Black <input type="checkbox"/>	Golden <input type="checkbox"/>	Green <input type="checkbox"/>
	PACKING	Bulk Pack <input type="checkbox"/>	White Box+Sticker <input type="checkbox"/>	Gift Box <input type="checkbox"/>	Head Card <input type="checkbox"/>
	STANDARD	2602M:40Pcs/Ctn, Measure: 64x45x40cm, G.W/N.W: 17/16kgs ; 2602B:16Pcs/Ctn, Measure: 65x33x35cm,G.W/N.W:14/13kgs			
	USE FOR	Catch Mouse			

	NAME	Pro Single Door Mouse/Rat Trap Cage	ITEM NO.:	HC2601S	
	MATERIAL	steel 550g	Wire Dia: 1.0mm	MESH SIZE	
	SIZE	33x13x11cm			
	SURFACE	Galvanizing <input type="checkbox"/>	Powder Coating <input type="checkbox"/>	Electrophoretic Paint <input type="checkbox"/>	
	COLOR	Sliver <input type="checkbox"/>	Black <input type="checkbox"/>	Golden <input type="checkbox"/>	Green <input type="checkbox"/>
	PACKING	Bulk Pack <input type="checkbox"/>	White Box+Sticker <input type="checkbox"/>	Gift Box <input type="checkbox"/>	Head Card <input type="checkbox"/>
	STANDARD	20Pcs/Ctn, Measure: 68x36x48cm,G.W/N.W:12/11kgs			
	USE FOR	Catch Mouse			

	NAME	Pro Double Door Mouse/Rat Trap Cage	ITEM NO.:	HC2601D	
	MATERIAL	Steel 680g	Wire Dia: 1.0mm	MESH SIZE	
	SIZE	42x13x11.4cm			
	SURFACE	Galvanizing <input type="checkbox"/>	Powder Coating <input type="checkbox"/>	Electrophoretic Paint <input type="checkbox"/>	
	COLOR	Sliver <input type="checkbox"/>	Black <input type="checkbox"/>	Golden <input type="checkbox"/>	Green <input type="checkbox"/>
	PACKING	Bulk Pack <input type="checkbox"/>	White Box+Sticker <input type="checkbox"/>	Gift Box <input type="checkbox"/>	Head Card <input type="checkbox"/>
	STANDARD	18Pcs/Ctn, Measure: 81.5x46x39.5cm,G.W/N.W:13.24/12.24kgs			
	USE FOR	Catch Mouse			





Rodent Control

















	NAME	Multi Catch Rodent Trap			ITEM NO.:	HC2608
	MATERIAL	Steel 530g	Wire Dia	1.7mm	MESH SIZE	3x3cm
	SIZE	41x23.3x16.4cm				
	SURFACE	Galvanizing <input type="checkbox"/>	Powder Coating <input type="checkbox"/>	Electrophoretic Paint <input type="checkbox"/>		
	COLOR	Sliver <input type="checkbox"/>	Black <input type="checkbox"/>	Golden <input type="checkbox"/>	Green <input type="checkbox"/>	
	PACKING	Bulk Pack <input type="checkbox"/>	WHITE BOX+STICKER <input type="checkbox"/>	Gift Box <input type="checkbox"/>	Head Card <input type="checkbox"/>	
	STANDARD	6Pcs/Ctn, Measure: 46x41.5x55.5cm, G.W/N.W: 4.18/3.18kgs				
	USE FOR	Catch Mouse				

	NAME	Multi Catch Rodent Trap			ITEM NO.:	HC2608C
	MATERIAL	Steel 1080g	Wire Dia	1.7mm	MESH SIZE	3x3cm
	SIZE	40X21X18.5cm				
	SURFACE	Galvanizing <input type="checkbox"/>	Powder Coating <input type="checkbox"/>	Electrophoretic Paint <input type="checkbox"/>		
	COLOR	Sliver <input type="checkbox"/>	Black <input type="checkbox"/>	Golden <input type="checkbox"/>	Green <input type="checkbox"/>	
	PACKING	Bulk Pack <input type="checkbox"/>	White Box+Sticker <input type="checkbox"/>	Gift Box <input type="checkbox"/>	Head Card <input type="checkbox"/>	
	STANDARD	6Pcs/Ctn, Measure: 46x41.5x55.5cm, G.W/N.W: 7/6kgs				
	USE FOR	Catch Mouse				

	NAME	Squirrel/Wild Cat Trap Cage			ITEM NO.:	HC2610
	MATERIAL	STEEL 2500g	Wire Dia	2.4MM	MESH SIZE	30x30mm
	SIZE	50X18X18CM				
	SURFACE	Galvanizing <input type="checkbox"/>	Powder Coating <input type="checkbox"/>	Electrophoretic Paint <input type="checkbox"/>		
	COLOR	Sliver <input type="checkbox"/>	Black <input type="checkbox"/>	Golden <input type="checkbox"/>	Green <input type="checkbox"/>	
	PACKING	Bulk Pack <input type="checkbox"/>	white Box+Sticker <input type="checkbox"/>	Gift Box <input type="checkbox"/>	Head Card <input type="checkbox"/>	
	STANDARD	1Pc/Ctn, Measure: 55.5x23.5x23.5cm, G.W/N.W: 3.1/2.5kgs				
	USE FOR	Catch Squirrel and Wild Cat				

	NAME	Multi Catch Rodent Trap			ITEM NO.:	HC2615
	MATERIAL	Steel wire 790g	Wire Dia	2.0mm	MESH SIZE	
	SIZE	36.2x18x16.3cm				
	SURFACE	Galvanizing <input type="checkbox"/>	Powder Coating <input type="checkbox"/>	Electrophoretic Paint <input type="checkbox"/>		
	COLOR	Sliver <input type="checkbox"/>	Black <input type="checkbox"/>	Golden <input type="checkbox"/>	Green <input type="checkbox"/>	
	PACKING	Bulk Pack <input type="checkbox"/>	White Box+Sticker <input type="checkbox"/>	Gift Box <input type="checkbox"/>	Head Card <input type="checkbox"/>	
	STANDARD	6Pcs/Ctn, Measure: 51.5x38.2x38cm, G.W/N.W: 5.8/4.8kgs				
	USE FOR	Catch Mouse				

	NAME	Squirrel/Wild Cat Trap Cage			ITEM NO.:	HC2616
	MATERIAL	Steel 1230g	WIRE DIA	2.0mm	MESH SIZE	1x2inch
	SIZE	41.5x15.5x16.5cm				
	SURFACE	Galvanizing <input type="checkbox"/>	Powder Coating <input type="checkbox"/>	Electrophoretic Paint <input type="checkbox"/>		
	COLOR	Sliver <input type="checkbox"/>	Black <input type="checkbox"/>	Golden <input type="checkbox"/>	Green <input type="checkbox"/>	
	PACKING	Bulk Pack <input type="checkbox"/>	White Box+Sticker <input type="checkbox"/>	Gift Box <input type="checkbox"/>	Head Card <input type="checkbox"/>	
	STANDARD	6Pcs/Ctn, Measure: 48.5x43.5x35cm, G.W/N.W: 8.38/7.38kgs				
	USE FOR	Catch Mouse				

			
HC2421	HC2422	HC2418	HC2423
			
HC2424	HC2419	HC2412	HC2413
			
HC2708	HC2414	HC2417	HC2425
			
HC2704	HC2426	HC2427	HC2428



Wild Animal Control

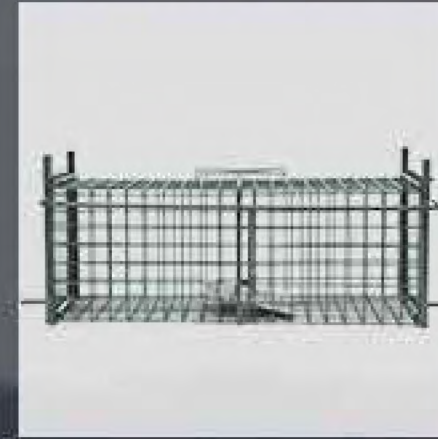

Single door foldable animal trap cage



Single door foldable animal trap cage

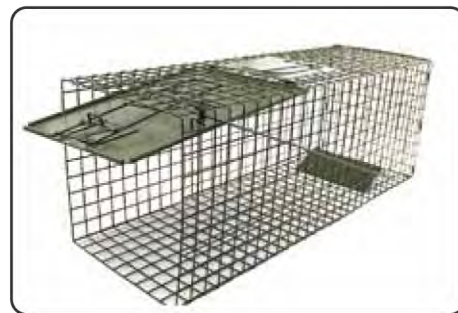

Double door foldable animal trap cage



Double door foldable animal trap cage



	NAME	Sigle Door Wilde Animal Trap Cage		ITEM NO.:	HC2607
	MATERIAL	Steel Wire 4500g	Wire Dia 2.4mm	MESH SIZE	30x30mm
	SIZE	75x26x30cm			
	SURFACE	Galvanizing <input type="checkbox"/>	Powder Coating <input type="checkbox"/>	Electrophoretic Paint <input type="checkbox"/>	
	COLOR	Sliver <input type="checkbox"/>	Black <input type="checkbox"/>	Golden <input type="checkbox"/>	Green <input type="checkbox"/>
	PACKING	Bulk Pack <input type="checkbox"/>	White Box+Sticker <input type="checkbox"/>	Gift Box <input type="checkbox"/>	Head Card <input type="checkbox"/>
	STANDARD	1Pc/Ctn, Measure: 78x30x35cm, G.W/N.W: 5.5/4.5kgs			
	USE FOR	Catch Wild Animals			

	NAME	Foldable Wilde Animal Trap Cage		ITEM NO.:	HC2609
	MATERIAL	Steel Wire	Wire Dia 2.4mm	MESH SIZE	30x30mm
	SIZE	60x17x20cm <input type="checkbox"/> 75x26x30cm <input type="checkbox"/> 100x26x30 <input type="checkbox"/> 120x26x30cm <input type="checkbox"/> 150x26x30cm <input type="checkbox"/> 150x30x40cm <input type="checkbox"/> 160x50x55cm <input type="checkbox"/>			
	SURFACE	Galvanizing <input type="checkbox"/>	Powder Coating <input type="checkbox"/>	Electrophoretic Paint <input type="checkbox"/>	
	COLOR	Sliver <input type="checkbox"/>	Black <input type="checkbox"/>	Golden <input type="checkbox"/>	Green <input type="checkbox"/>
	PACKING	Bulk Pack <input type="checkbox"/>	White Box+Sticker <input type="checkbox"/>	Gift Box <input type="checkbox"/>	Head Card <input type="checkbox"/>
	STANDARD	1Pc/Ctn			
	USE FOR	Catch Wild Animals			

	NAME	Sigle Door Wilde Animal Trap Cage		ITEM NO.:	HC2611
	MATERIAL	Steel Wire 4500g	Wire Dia 2.4mm	MESH SIZE	30x30mm
	SIZE	75x26x30cm			
	SURFACE	Galvanizing <input type="checkbox"/>	Powder Coating <input type="checkbox"/>	Electrophoretic Paint <input type="checkbox"/>	
	COLOR	Sliver <input type="checkbox"/>	Black <input type="checkbox"/>	Golden <input type="checkbox"/>	Green <input type="checkbox"/>
	PACKING	Bulk Pack <input type="checkbox"/>	White Box+Sticker <input type="checkbox"/>	Gift Box <input type="checkbox"/>	Head Card <input type="checkbox"/>
	STANDARD	1Pc/Ctn, Measure: 78x30x35cm, G.W/N.W: 5.5/4.5kgs			
	USE FOR	Catch Wild Animals			

	NAME	Double Door Wilde Animal Trap Cage		ITEM NO.:	HC2610S
	MATERIAL	Steel wire	Wire Dia 2.4mm	MESH SIZE	30x30mm
	SIZE	60x17x20cm <input type="checkbox"/> 50x18x18cm <input type="checkbox"/>			
	SURFACE	Galvanizing <input type="checkbox"/>	Powder Coating <input type="checkbox"/>	Electrophoretic Paint <input type="checkbox"/>	
	COLOR	Sliver <input type="checkbox"/>	Black <input type="checkbox"/>	Golden <input type="checkbox"/>	Green <input type="checkbox"/>
	PACKING	Bulk Pack <input type="checkbox"/>	white Box+Sticker <input type="checkbox"/>	Gift Box <input type="checkbox"/>	Head Card <input type="checkbox"/>
	STANDARD	1Pc/Ctn, Measure: 65.5x22.5x25.5cm			
	USE FOR	Catch Wild Animals			

	NAME	Foldable Wilde Animal Trap Cage		ITEM NO.:	HC2613
	MATERIAL	Steel Wire	Wire Dia 2.4mm	MESH SIZE	30x30mm
	SIZE	75x26x30cm <input type="checkbox"/> 100x26x30cm <input type="checkbox"/> 120x26x30cm <input type="checkbox"/> 150x26x30cm <input type="checkbox"/> 150x30x40cm <input type="checkbox"/> 160x50x55cm <input type="checkbox"/>			
	SURFACE	Galvanizing <input type="checkbox"/>	Powder Coating <input type="checkbox"/>	Electrophoretic Paint <input type="checkbox"/>	
	COLOR	Sliver <input type="checkbox"/>	Black <input type="checkbox"/>	Golden <input type="checkbox"/>	Green <input type="checkbox"/>
	PACKING	Bulk Pack <input type="checkbox"/>	White Box+Sticker <input type="checkbox"/>	Gift Box <input type="checkbox"/>	Head Card <input type="checkbox"/>
	STANDARD	1Pc/Ctn			
	USE FOR	Catch wild animals			





	NAME	Pro Stronger Wilde Animal Trap Cage		ITEM NO.:	HC2614S
	MATERIAL	Steel Wire	WIRE DIA 2.4mm	MESH SIZE	30x30mm
	SIZE	46x14x13cm		TYPE	Standard <input type="checkbox"/> Foldable <input type="checkbox"/>
	SURFACE	Galvanizing <input type="checkbox"/>	Powder Coating <input type="checkbox"/>	Electrophoretic Paint <input type="checkbox"/>	
	COLOR	Sliver <input type="checkbox"/>	Black <input type="checkbox"/>	Golden <input type="checkbox"/>	Green <input type="checkbox"/>
	PACKING	Bulk Pack <input type="checkbox"/>	White Box+Sticker <input type="checkbox"/>	Gift Box <input type="checkbox"/>	Head Card <input type="checkbox"/>
	STANDARD	1Pc/Ctn Measure: 48x16x15 cm			
	USE FOR	Catch Wild Animals			

	NAME	Pro Stronger Wilde Animal Trap Cage		ITEM NO.:	HC2614M
	MATERIAL	Steel Wire	WIRE DIA 2.4mm	MESH SIZE	2.5x2.5cm
	SIZE	S: 62x20x21.5cm 2620g F:66x25x25cm		TYPE	Standard <input type="checkbox"/> Foldable <input type="checkbox"/>
	SURFACE	Galvanizing <input type="checkbox"/>	Powder Coating <input type="checkbox"/>	Electrophoretic Paint <input type="checkbox"/>	
	COLOR	Sliver <input type="checkbox"/>	Black <input type="checkbox"/>	Golden <input type="checkbox"/>	Green <input type="checkbox"/>
	PACKING	Bulk Pack <input type="checkbox"/>	White Box+Sticker <input type="checkbox"/>	Gift Box <input type="checkbox"/>	Head Card <input type="checkbox"/>
	STANDARD	1Pcs/Ctn, Measure: 65x23x24.5cm , G.W/N.W:3.12/2.62kgs			
	USE FOR	Catch Wild Animals			

	NAME	Pro Stronger Wilde Animal Trap Cage		ITEM NO.:	HC2614L
	MATERIAL	Steel Wire	WIRE DIA 2.4mm	MESH SIZE	2.9x2.8cm
	SIZE	S: 83x30x30cm 4300g F:78x30x32cm 4800g		TYPE	STANDARD <input type="checkbox"/> FOLDABLE <input type="checkbox"/>
	SURFACE	Galvanizing <input type="checkbox"/>	Powder Coating <input type="checkbox"/>	Electrophoretic Paint <input type="checkbox"/>	
	COLOR	Sliver <input type="checkbox"/>	Black <input type="checkbox"/>	Golden <input type="checkbox"/>	Green <input type="checkbox"/>
	PACKING	Bulk Pack <input type="checkbox"/>	White Box+Sticker <input type="checkbox"/>	Gift Box <input type="checkbox"/>	Head Card <input type="checkbox"/>
	STANDARD	S:1Pc/Ctn, Measure: 85x32x32cm , G.W/N.W:4.8/4.3kgs F:1Pc/Ctn, Measure: 93.5x31x9cm , G.W/N.W:5.3/4.8kgs			
	USE FOR	Catch Wild Animals			

	NAME	Pro Stronger Wilde Animal Trap Cage		ITEM NO.:	HC2615M
	MATERIAL	Steel Wire 3000g	WIRE DIA 2.4mm	MESH SIZE	2.5x2.5cm
	SIZE	66x25x25cm		TYPE	STANDARD <input type="checkbox"/> FOLDABLE <input type="checkbox"/>
	SURFACE	Galvanizing <input type="checkbox"/>	Powder Coating <input type="checkbox"/>	Electrophoretic Paint <input type="checkbox"/>	
	COLOR	Sliver <input type="checkbox"/>	Black <input type="checkbox"/>	Golden <input type="checkbox"/>	Green <input type="checkbox"/>
	PACKING	Bulk Pack <input type="checkbox"/>	White Box+Sticker <input type="checkbox"/>	Gift Box <input type="checkbox"/>	Head Card <input type="checkbox"/>
	STANDARD	1Pc/Ctn, Measure: 77x25x8.5cm , G.W/N.W:3.5/3kgs			
	USE FOR	Catch Wild Animals			

	NAME	Pro Stronger Wilde Animal Trap Cage		ITEM NO.:	HC2615L
	MATERIAL	Steel Wire 4500g	Wire Dia 2.4mm	MESH SIZE	2.9x2.8cm
	SIZE	78x30x32cm		TYPE	STANDARD <input type="checkbox"/> FOLDABLE <input type="checkbox"/>
	SURFACE	Galvanizing <input type="checkbox"/>	Powder Coating <input type="checkbox"/>	Electrophoretic Paint <input type="checkbox"/>	
	COLOR	Sliver <input type="checkbox"/>	Black <input type="checkbox"/>	Golden <input type="checkbox"/>	Green <input type="checkbox"/>
	PACKING	Bulk Pack <input type="checkbox"/>	White Box+Sticker <input type="checkbox"/>	Gift Box <input type="checkbox"/>	Head Card <input type="checkbox"/>
	STANDARD	1Pc/Ctn Measure: 93.5x31x9cm , G.W/N.W:5/4.5kgs			
	USE FOR	Catch Wild Animals			

	NAME	Easy Spring Leg Trap		ITEM NO.:	HC2701
	MATERIAL	Steel Sheet+Spring			120g
	SIZE	110x110x70mm			
	SURFACE	Galvanizing <input type="checkbox"/>	Powder Coating <input type="checkbox"/>	Electrophoretic Paint <input type="checkbox"/>	
	COLOR	Sliver <input type="checkbox"/>	Black <input type="checkbox"/>	Golden <input type="checkbox"/>	Green <input type="checkbox"/>
	PACKING	Bulk Pack <input type="checkbox"/>	White Box+Sticker <input type="checkbox"/>	Gift Box <input type="checkbox"/>	Head Card <input type="checkbox"/>
	STANDARD	100Pcs/Ctn, Measure: 33x28x24.5cm, G.W/N.W: 14.65/13.65kgs			
	USE FOR	Catch The Wild Vole, Gopher, Mole And Similar Animals			

	NAME	Easy Spring Leg Trap		ITEM NO.:	HC2702M4
	MATERIAL	Steel Sheet+Spring			340g
	SIZE	110x110x75mm			
	SURFACE	Galvanizing <input type="checkbox"/>	Powder Coating <input type="checkbox"/>	Electrophoretic Paint <input type="checkbox"/>	
	COLOR	Sliver <input type="checkbox"/>	Black <input type="checkbox"/>	Golden <input type="checkbox"/>	Green <input type="checkbox"/>
	PACKING	Bulk Pack <input type="checkbox"/>	White Box+Sticker <input type="checkbox"/>	Gift Box <input type="checkbox"/>	Head Card <input type="checkbox"/>
	STANDARD	12Pcs/Ctn, Measure: 40.5x25x9.5, G.W/N.W:5.08/4.08kgs			
	USE FOR	Catch The Wild Vole, Gopher, Mole And Similar Animals			

	NAME	Pro Spring Leg Trap		ITEM NO.:	HC2702M6
	MATERIAL	Steel Sheet+Spring			660g
	SIZE	150x150x100mm			
	SURFACE	Galvanizing <input type="checkbox"/>	Powder Coating <input type="checkbox"/>	Electrophoretic Paint <input type="checkbox"/>	
	COLOR	Sliver <input type="checkbox"/>	Black <input type="checkbox"/>	Golden <input type="checkbox"/>	Green <input type="checkbox"/>
	PACKING	Bulk Pack <input type="checkbox"/>	White Box+Sticker <input type="checkbox"/>	Gift Box <input type="checkbox"/>	Head Card <input type="checkbox"/>
	STANDARD	12Pcs/Ctn			
	USE FOR	Catch The Wild Vole, Gopher, Mole And Similar Animals			

	NAME	Pro Spring Leg Trap		ITEM NO.:	HC2702M6S
	MATERIAL	Steel Sheet+Spring			674g
	SIZE	150x150x100mm			
	SURFACE	Galvanizing <input type="checkbox"/>	Powder Coating <input type="checkbox"/>	Electrophoretic Paint <input type="checkbox"/>	
	COLOR	Sliver <input type="checkbox"/>	Black <input type="checkbox"/>	Golden <input type="checkbox"/>	Green <input type="checkbox"/>
	PACKING	Bulk Pack <input type="checkbox"/>	White Box+Sticker <input type="checkbox"/>	Gift Box <input type="checkbox"/>	Head Card <input type="checkbox"/>
	STANDARD	12Pcs/Ctn			
	USE FOR	Catch The Wild Vole, Gopher, Mole And Similar Animals			

	NAME	Pro Spring Leg Trap		ITEM NO.:	HC2702M8
	MATERIAL	Steel Sheet+Spring			990g
	SIZE	165x140x115mm			
	SURFACE	Galvanizing <input type="checkbox"/>	Powder Coating <input type="checkbox"/>	Electrophoretic Paint <input type="checkbox"/>	
	COLOR	Sliver <input type="checkbox"/>	Black <input type="checkbox"/>	Golden <input type="checkbox"/>	Green <input type="checkbox"/>
	PACKING	Bulk Pack <input type="checkbox"/>	White Box+Sticker <input type="checkbox"/>	Gift Box <input type="checkbox"/>	Head Card <input type="checkbox"/>
	STANDARD	12Pcs/Ctn			
	USE FOR	Catch The Wild Vole, Gopher, Mole And Similar Animals			





Animal Control

	NAME	Pro Spring Leg Trap			ITEM NO.:	HC2702M8S1
	MATERIAL	Steel Sheet+Spring				970g
	SIZE	165x140x115mm				
	SURFACE	Galvanizing <input type="checkbox"/>	Powder Coating <input type="checkbox"/>	Electrophoretic Paint <input type="checkbox"/>		
	COLOR	Sliver <input type="checkbox"/>	Black <input type="checkbox"/>	Golden <input type="checkbox"/>	Green <input type="checkbox"/>	
	PACKING	Bulk Pack <input type="checkbox"/>	White Box+Sticker <input type="checkbox"/>	Gift Box <input type="checkbox"/>	Head Card <input type="checkbox"/>	
	STANDARD	12Pcs/Ctn				
	USE FOR	Catch The Wild Vole, Gopher, Mole And Similar Animals				

	NAME	X Super Strong Spring Leg Trap			ITEM NO.:	HC2715M8
	MATERIAL	Steel Sheet+Spring				2330g
	SIZE	33x33cm				
	SURFACE	Galvanizing <input type="checkbox"/>	Powder Coating <input type="checkbox"/>	Electrophoretic Paint <input type="checkbox"/>		
	COLOR	Sliver <input type="checkbox"/>	Black <input type="checkbox"/>	Golden <input type="checkbox"/>	Green <input type="checkbox"/>	
	PACKING	Bulk Pack <input type="checkbox"/>	White Box+Sticker <input type="checkbox"/>	Gift Box <input type="checkbox"/>	Head Card <input type="checkbox"/>	
	STANDARD	8Pcs/Ctn, Measure: 63x33x33cm, G.W/N.W:19.64/18.64kgs				
	USE FOR	Catch The Wild Vole, Gopher, Mole And Similar Animals				

	NAME	Pro Spring Leg Trap			ITEM NO.:	HC2702M8S2
	MATERIAL	Steel Sheet+Spring				970g
	SIZE	165x140x115mm				
	SURFACE	Galvanizing <input type="checkbox"/>	Powder Coating <input type="checkbox"/>	Electrophoretic Paint <input type="checkbox"/>		
	COLOR	Sliver <input type="checkbox"/>	Black <input type="checkbox"/>	Golden <input type="checkbox"/>	Green <input type="checkbox"/>	
	PACKING	Bulk Pack <input type="checkbox"/>	White Box+Sticker <input type="checkbox"/>	Gift Box <input type="checkbox"/>	Head Card <input type="checkbox"/>	
	STANDARD	12Pcs/Ctn				
	USE FOR	Catch The Wild Vole, Gopher, Mole And Similar Animals				

	NAME	Spring Leg Trap Setting Tools			ITEM NO.:	HC2715T
	MATERIAL	Steel Sheet				
	SIZE	10x600mm				
	SURFACE	Galvanizing <input type="checkbox"/>	Powder Coating <input type="checkbox"/>	Electrophoretic Paint <input type="checkbox"/>		
	COLOR	Sliver <input type="checkbox"/>	Black <input type="checkbox"/>	Golden <input type="checkbox"/>	Green <input type="checkbox"/>	
	PACKING	Bulk Pack <input type="checkbox"/>	White Box+Sticker <input type="checkbox"/>	Gift Box <input type="checkbox"/>	Head Card <input type="checkbox"/>	
	STANDARD					
	USE FOR					

	NAME	X Spring Leg Trap			ITEM NO.:	HC2715M4
	MATERIAL	Steel Sheet+Spring				300g
	SIZE	13x13cm				
	SURFACE	Galvanizing <input type="checkbox"/>	Powder Coating <input type="checkbox"/>	Electrophoretic Paint <input type="checkbox"/>		
	COLOR	Sliver <input type="checkbox"/>	Black <input type="checkbox"/>	Golden <input type="checkbox"/>	Green <input type="checkbox"/>	
	PACKING	Bulk Pack <input type="checkbox"/>	White Box+Sticker <input type="checkbox"/>	Gift Box <input type="checkbox"/>	Head Card <input type="checkbox"/>	
	STANDARD	42Pcs/Ctn, Measure: 63x33x33cm, G.W/N.W:13.6/12.6kgs				
	USE FOR	Catch the wild vole, gopher, mole and similar animals				

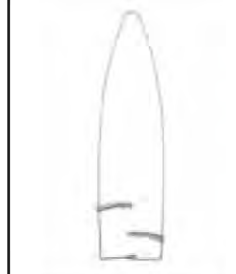
	NAME	Farm Animal Tools			ITEM NO.:	HC2717
	MATERIAL	Steel Sheet+Spring				
	SIZE					
	SURFACE	Galvanizing <input type="checkbox"/>	Powder Coating <input type="checkbox"/>	Electrophoretic Paint <input type="checkbox"/>		
	COLOR	Sliver <input type="checkbox"/>	Black <input type="checkbox"/>	Golden <input type="checkbox"/>	Green <input type="checkbox"/>	
	PACKING	Bulk Pack <input type="checkbox"/>	White Box+Sticker <input type="checkbox"/>	Gift Box <input type="checkbox"/>	Head Card <input type="checkbox"/>	
	STANDARD					
	USE FOR	Catch The Wild Vole, Gopher, Mole And Similar Animals				

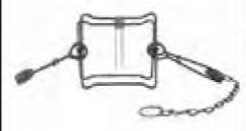
	NAME	X Spring Leg Trap			ITEM NO.:	HC2715M4S
	MATERIAL	Steel Sheet+Spring				370g
	SIZE	13x13cm				
	SURFACE	Galvanizing <input type="checkbox"/>	POWDER COATING <input type="checkbox"/>	ELECTROPHORETIC PAINT <input type="checkbox"/>		
	COLOR	Sliver <input type="checkbox"/>	BLACK <input type="checkbox"/>	GOLDEN <input type="checkbox"/>	GREEN <input type="checkbox"/>	
	PACKING	Bulk Pack <input type="checkbox"/>	WHITE BOX+STICKER <input type="checkbox"/>	GIFT BOX <input type="checkbox"/>	HEAD CARD <input type="checkbox"/>	
	STANDARD	42Pcs/Ctn, Measure: 63x33x33cm, G.W/N.W:16.54/15.54kgs				
	USE FOR	Catch The Wild Vole, Gopher, Mole And Similar Animals				

	NAME	Trap Setting Tools			ITEM NO.:	HC2718
	MATERIAL	Steel Sheet+Mesh				400g
	SIZE	S: 25.7x21x6.5CM <input type="checkbox"/> M: <input type="checkbox"/> L: <input type="checkbox"/>				
	SURFACE	Galvanizing <input type="checkbox"/>	Powder Coating <input type="checkbox"/>	Electrophoretic Paint <input type="checkbox"/>		
	COLOR	Sliver <input type="checkbox"/>	Black <input type="checkbox"/>	Golden <input type="checkbox"/>	Green <input type="checkbox"/>	
	PACKING	Bulk Pack <input type="checkbox"/>	White Box+Sticker <input type="checkbox"/>	Gift Box <input type="checkbox"/>	Head Card <input type="checkbox"/>	
	STANDARD	24Pcs/Ctn, Measure: 29.5x24.5x29.5cm, G.W/N.W:10.6/9.6kgs				
	USE FOR	Use With The Mole Trap				

	NAME	X Spring Leg Trap			ITEM NO.:	HC2715M6
	MATERIAL	Steel Sheet+Spring				1030g
	SIZE	22x22cm				
	SURFACE	Galvanizing <input type="checkbox"/>	Powder Coating <input type="checkbox"/>	Electrophoretic Paint <input type="checkbox"/>		
	COLOR	Sliver <input type="checkbox"/>	Black <input type="checkbox"/>	Golden <input type="checkbox"/>	Green <input type="checkbox"/>	
	PACKING	Bulk Pack <input type="checkbox"/>	White Box+Sticker <input type="checkbox"/>	Gift Box <input type="checkbox"/>	Head Card <input type="checkbox"/>	
	STANDARD	20Pcs/Ctn, Measure: 63x33x33cm, G.W/N.W:21.6/20.6 kgs				
	USE FOR	Catch The Wild Vole, Gopher, Mole And Similar Animals				

	NAME	Easy Mole/Vole /Gopher Trap			ITEM NO.:	HC2719
	MATERIAL	Steel Sheet+Spring				
	SIZE	Ask customers requested				
	SURFACE	Galvanizing <input type="checkbox"/>	Powder Coating <input type="checkbox"/>	Electrophoretic Paint <input type="checkbox"/>		
	COLOR	Sliver <input type="checkbox"/>	Black <input type="checkbox"/>	Golden <input type="checkbox"/>	Green <input type="checkbox"/>	
	PACKING	Bulk Pack <input type="checkbox"/>	White Box+Sticker <input type="checkbox"/>	Gift Box <input type="checkbox"/>	Head Card <input type="checkbox"/>	
	STANDARD					
	USE FOR	Catch the wild vole, gopher, mole and similar animals				



Simple and easy to operate

Flexible trigger, Just hold the trigger in your hand and catch the animals at a long distance.

Advanced material

High quality polishing treatment let it fit very well to human's hands , make it more comfortable to use.

Easy to store

The shape is just a stick and It can be made to the foldable . You can also hang it on a hook or on a nail or anywhere you prefer.





Reptile Control

	NAME	Pro Snake Control Tong		ITEM NO.:	HC3101
	SIZE	24", 30", 40", 42", 47", 52", 72"		MATERIAL	Aluminium
	EXTRA SERVICE	OEM/ODM <input type="checkbox"/>	Design For Customer <input type="checkbox"/>	Develop New Item <input type="checkbox"/>	
	SURFACE	Galvanizing <input type="checkbox"/>	Powder Coating <input type="checkbox"/>	Electrophoretic Paint <input type="checkbox"/>	
	COLOR	Sliver <input type="checkbox"/>	Red <input type="checkbox"/>	Blue <input type="checkbox"/>	Sliver <input type="checkbox"/>
	PACKING	Bulk Pack <input type="checkbox"/>	White Box+Sticker <input type="checkbox"/>	Gift Box <input type="checkbox"/>	Head Card <input type="checkbox"/>
	STANDARD	52":20Pcs/Ctn,Measure:147x25x18cm,G.W./N.W:14.6/13.6kgs			
	USE FOR	Catch Snake			

	NAME	Easy Snake Control Tong		ITEM NO.:	HC3105
	SIZE	24", 30", 40", 42", 47", 52", 72"		MATERIAL	Stainless Steel
	SURFACE	Galvanizing <input type="checkbox"/>	Powder Coating <input type="checkbox"/>	Electrophoretic Paint <input type="checkbox"/>	
	COLOR	Sliver <input type="checkbox"/>	Red <input type="checkbox"/>	Blue <input type="checkbox"/>	Sliver <input type="checkbox"/>
	PACKING	Bulk Pack <input type="checkbox"/>	White Box+Sticker <input type="checkbox"/>	Gift Box <input type="checkbox"/>	Head Card <input type="checkbox"/>
	STANDARD	52":20Pcs/Ctn,147x25x18cm,G.W./N.W.:14.6/13.6kgs			

	NAME	Pro Snake Control Tong		ITEM NO.:	HC3102
	SIZE	24", 30", 40", 42", 47", 52", 72"		MATERIAL	Aluminium
	EXTRA SERVICE	OEM/ODM <input type="checkbox"/>	Design For Customer <input type="checkbox"/>	Develop New Item <input type="checkbox"/>	
	SURFACE	Galvanizing <input type="checkbox"/>	Powder Coating <input type="checkbox"/>	Electrophoretic Paint <input type="checkbox"/>	
	COLOR	Sliver <input type="checkbox"/>	Red <input type="checkbox"/>	Blue <input type="checkbox"/>	Sliver <input type="checkbox"/>
	PACKING	Bulk Pack <input type="checkbox"/>	White Box+Sticker <input type="checkbox"/>	Gift Box <input type="checkbox"/>	Head Card <input type="checkbox"/>
	STANDARD	52":20Pcs/Ctn,Measure:147x25x18cm,G.W./N.W:14.6/13.6kgs			
	USE FOR	Catch Snake			

	NAME	Easy Foldable Snake Control Tong		ITEM NO.:	HC3105F
	SIZE	24", 30", 40", 42", 47", 52", 72"		MATERIAL	Stainless Steel
	SURFACE	Galvanizing <input type="checkbox"/>	Powder Coating <input type="checkbox"/>	Electrophoretic Paint <input type="checkbox"/>	
	COLOR	Sliver <input type="checkbox"/>	Red <input type="checkbox"/>	Blue <input type="checkbox"/>	Sliver <input type="checkbox"/>
	PACKING	Bulk Pack <input type="checkbox"/>	White Box+Sticker <input type="checkbox"/>	Gift Box <input type="checkbox"/>	Head Card <input type="checkbox"/>
	STANDARD	52":20Pcs/Ctn,147x25x18cm,G.W./N.W.:14.6/13.6kgs			

	NAME	Foldable Small Animal Control Tong		ITEM NO.:	HC3101F
	SIZE	24", 30", 40", 42", 47", 52", 72"		MATERIAL	Aluminium
	EXTRA SERVICE	OEM/ODM <input type="checkbox"/>	Design For Customer <input type="checkbox"/>	Develop New Item <input type="checkbox"/>	
	SURFACE	Galvanizing <input type="checkbox"/>	Powder Coating <input type="checkbox"/>	Electrophoretic Paint <input type="checkbox"/>	
	COLOR	Sliver <input type="checkbox"/>	Red <input type="checkbox"/>	Blue <input type="checkbox"/>	Sliver <input type="checkbox"/>
	PACKING	Bulk Pack <input type="checkbox"/>	White Box+Sticker <input type="checkbox"/>	Gift Box <input type="checkbox"/>	Head Card <input type="checkbox"/>
	STANDARD	52":20Pcs/Ctn,Measure:147x25x18cm,G.W./N.W:14.6/13.6kgs			
	USE FOR	Catch Snake			

	NAME	Small Animal Control Tong		ITEM NO.:	HC2707
	SIZE	24", 30", 40", 42", 47", 52", 72"		MATERIAL	Steel+Stainless
	SURFACE	Galvanizing <input type="checkbox"/>	Powder Coating <input type="checkbox"/>	Electrophoretic Paint <input type="checkbox"/>	
	COLOR	Sliver <input type="checkbox"/>	Red <input type="checkbox"/>	Blue <input type="checkbox"/>	Sliver <input type="checkbox"/>
	PACKING	Bulk Pack <input type="checkbox"/>	White Box+Sticker <input type="checkbox"/>	Gift Box <input type="checkbox"/>	Head Card <input type="checkbox"/>
	STANDARD	52":20Pcs/Ctn			
	USE FOR	Catch Snake			

	NAME	Snake Control Tong		ITEM NO.:	HC3102F
	SIZE	24", 30", 40", 42", 47", 52", 72"		MATERIAL	Aluminium
	EXTRA SERVICE	OEM/ODM <input type="checkbox"/>	Design For Customer <input type="checkbox"/>	Develop New Item <input type="checkbox"/>	
	SURFACE	Galvanizing <input type="checkbox"/>	Powder Coating <input type="checkbox"/>	Electrophoretic Paint <input type="checkbox"/>	
	COLOR	Sliver <input type="checkbox"/>	Red <input type="checkbox"/>	Blue <input type="checkbox"/>	Sliver <input type="checkbox"/>
	PACKING	Bulk Pack <input type="checkbox"/>	White Box+Sticker <input type="checkbox"/>	Gift Box <input type="checkbox"/>	Head Card <input type="checkbox"/>
	STANDARD	52":1Pc/Bundle,30Bundles/Ctn,Measure:69x58x31.5cm,G.W/N.W:23/22kgs			
	USE FOR	Catch Snake			

	NAME	Small Animal Control Tong		ITEM NO.:	HC3106
	SIZE	24", 30", 40", 42", 47", 52", 72"		MATERIAL	Aluminium
	SURFACE	Galvanizing <input type="checkbox"/>	Powder Coating <input type="checkbox"/>	Electrophoretic Paint <input type="checkbox"/>	
	COLOR	Sliver <input type="checkbox"/>	Red <input type="checkbox"/>	Blue <input type="checkbox"/>	Sliver <input type="checkbox"/>
	PACKING	Bulk Pack <input type="checkbox"/>	White Box+Sticker <input type="checkbox"/>	Gift Box <input type="checkbox"/>	Head Card <input type="checkbox"/>
	STANDARD	52":20Pcs/Ctn			
	USE FOR	Catch Small Animals			

	NAME	Easy Snake Control Tong		ITEM NO.:	HC3104
	SIZE	24", 30", 40", 42", 47", 52", 72"		MATERIAL	Aluminium
	EXTRA SERVICE	OEM/ODM <input type="checkbox"/>	Design For Customer <input type="checkbox"/>	Develop New Item <input type="checkbox"/>	
	SURFACE	Galvanizing <input type="checkbox"/>	Powder Coating <input type="checkbox"/>	Electrophoretic Paint <input type="checkbox"/>	
	COLOR	Sliver <input type="checkbox"/>	Red <input type="checkbox"/>	Blue <input type="checkbox"/>	
	PACKING	Bulk Pack <input type="checkbox"/>	White Box+Sticker <input type="checkbox"/>	Gift Box <input type="checkbox"/>	
	STANDARD	52":20Pcs/Ctn,Measure:147x25x18cm,G.W./N.W:14.6/13.6kgs			
	USE FOR	Catch Snake			

	NAME	FOLDABLE SMALL ANIMAL CONTROL TONGS		ITEM NO.:	HC3106F
	SIZE	24", 30", 40", 42", 47", 52", 72"		MATERIAL	Aluminium
	SURFACE	GALVANIZING <input type="checkbox"/>	Powder Coating <input type="checkbox"/>	Electrophoretic Paint <input type="checkbox"/>	
	COLOR	SLIVER <input type="checkbox"/>	Red <input type="checkbox"/>	Blue <input type="checkbox"/>	Sliver <input type="checkbox"/>
	PACKING	BULK PACK <input type="checkbox"/>	White Box+Sticker <input type="checkbox"/>	Gift Box <input type="checkbox"/>	Head Card <input type="checkbox"/>
	STANDARD	52":			
	USE FOR	Catch Small Animals			





	NAME	Snail/Slug Trap			ITEM NO.:	HC3201
	SIZE	12x12x10cm			MATERIAL	PP 83g
	ATTRACTION BAIT	Beer				
	COLOR	Sliver <input type="checkbox"/>	Red <input type="checkbox"/>	Blue <input type="checkbox"/>	Sliver <input type="checkbox"/>	
	PACKING	Bulk Pack <input type="checkbox"/>	White Box+Sticker <input type="checkbox"/>	Gift Box <input type="checkbox"/>	Head Card <input type="checkbox"/>	
	STANDARD	2Pcs/Box,12Boxes/CTN, Measure: 41.5x27x24cm, G.W/N.W:3.3/2.3kgs				
	USE FOR	Catch Snail, Effective And Easy To Use,No Chemicals---No Poisons,Durable, Reusable				

	NAME	Snail/Slug Trap			ITEM NO.:	HC3201
	SIZE	12x12x10cm			MATERIAL	PP 83g
	ATTRACTION BAIT	Beer				
	COLOR	Sliver <input type="checkbox"/>	Red <input type="checkbox"/>	Blue <input type="checkbox"/>	Sliver <input type="checkbox"/>	
	PACKING	Bulk Pack <input type="checkbox"/>	White Box+Sticker <input type="checkbox"/>	Gift Box <input type="checkbox"/>	Head Card <input type="checkbox"/>	
	STANDARD	2Pcs/Box,12Boxes/CTN, Measure: 41.5x27x24cm, G.W/N.W:3.3/2.3kgs				
	USE FOR	Catch Snail, Effective And Easy To Use,No Chemicals---No Poisons,Durable, Reusable				

	NAME	Snail/Slug Trap			ITEM NO.:	HC3202
	SIZE	11.5x10cm			MATERIAL	PP 42.5g
	ATTRACTION BAIT	Beer				
	COLOR	Sliver <input type="checkbox"/>	Red <input type="checkbox"/>	Blue <input type="checkbox"/>	Sliver <input type="checkbox"/>	
	PACKING	Bulk Pack <input type="checkbox"/>	White Box+Sticker <input type="checkbox"/>	Gift Box <input type="checkbox"/>	Head Card <input type="checkbox"/>	
	STANDARD	2Pcs/Box,12Boxes/CTN, Measure: 41.5x27x24cm, G.W/N.W:2.5/1.5kgs				
	USE FOR	Catch Snail, Effective And Easy To Use,No Chemicals---No Poisons,Durable, Reusable				

	NAME	Snail/Slug Trap			ITEM NO.:	HC3202
	SIZE	11.5x10cm			MATERIAL	PP 42.5g
	ATTRACTION BAIT	Beer				
	COLOR	Sliver <input type="checkbox"/>	Red <input type="checkbox"/>	Blue <input type="checkbox"/>	Sliver <input type="checkbox"/>	
	PACKING	Bulk Pack <input type="checkbox"/>	White Box+Sticker <input type="checkbox"/>	Gift Box <input type="checkbox"/>	Head Card <input type="checkbox"/>	
	STANDARD	2Pcs/Box,12Boxes/CTN, Measure: 41.5x27x24cm, G.W/N.W:2.5/1.5kgs				
	USE FOR	Catch Snail, Effective And Easy To Use,No Chemicals---No Poisons,Durable, Reusable				

	NAME	Insect Monitor			ITEM NO.:	HC3203
	SIZE	16x15cm			MATERIAL	ABS 116g
	COLOR	Sliver <input type="checkbox"/>	Red <input type="checkbox"/>	Blue <input type="checkbox"/>	Sliver <input type="checkbox"/>	
	PACKING	Bulk Pack <input type="checkbox"/>	White Box+Sticker <input type="checkbox"/>	Gift Box <input type="checkbox"/>	Head Card <input type="checkbox"/>	
	STANDARD	1Pc/Set,30Pcs/Ctn, Measure:59x42x45cm, G.W/N.W: 9.3/8.3kgs				
	USE FOR	Safely Catch And Remove: Spiders, Roaches, Scorpions, Flies, Crickets, Stink Bugs, Millipedes, Centipedes, Wasps, Yellow Jackets, Bees, Moths And MoreInsects				

	NAME	Insect Monitor			ITEM NO.:	HC3203
	SIZE	16x15cm			MATERIAL	ABS 116g
	COLOR	Sliver <input type="checkbox"/>	Red <input type="checkbox"/>	Blue <input type="checkbox"/>	Sliver <input type="checkbox"/>	
	PACKING	Bulk Pack <input type="checkbox"/>	White Box+Sticker <input type="checkbox"/>	Gift Box <input type="checkbox"/>	Head Card <input type="checkbox"/>	
	STANDARD	1Pc/Set,30Pcs/Ctn, Measure:59x42x45cm, G.W/N.W: 9.3/8.3kgs				
	USE FOR	Safely Catch And Remove: Spiders, Roaches, Scorpions, Flies, Crickets, Stink Bugs, Millipedes, Centipedes, Wasps, Yellow Jackets, Bees, Moths And MoreInsects				

	NAME	Insect Monitor			ITEM NO.:	HC3204
	SIZE	14x7x10cm			MATERIAL	ABS 117g
	COLOR	Sliver <input type="checkbox"/>	Red <input type="checkbox"/>	Blue <input type="checkbox"/>	Sliver <input type="checkbox"/>	
	PACKING	Bulk Pack <input type="checkbox"/>	White Box+Sticker <input type="checkbox"/>	Gift Box <input type="checkbox"/>	Head Card <input type="checkbox"/>	
	STANDARD	1Pc/Set,30Pcs/Ctn, Measure:44x31x30cm, G.W/N.W: 4.5/3.5kgs				
	USE FOR	Safely Catch And Remove: Spiders, Roaches, Scorpions, Flies, Crickets, Stink Bugs, Millipedes, Centipedes, Wasps, Yellow Jackets, Bees, Moths And MoreInsects				

	NAME	Insect Monitor			ITEM NO.:	HC3204
	SIZE	14x7x10cm			MATERIAL	ABS 117g
	COLOR	Sliver <input type="checkbox"/>	Red <input type="checkbox"/>	Blue <input type="checkbox"/>	Sliver <input type="checkbox"/>	
	PACKING	Bulk Pack <input type="checkbox"/>	White Box+Sticker <input type="checkbox"/>	Gift Box <input type="checkbox"/>	Head Card <input type="checkbox"/>	
	STANDARD	1Pc/Set,30Pcs/Ctn, Measure:44x31x30cm, G.W/N.W: 4.5/3.5kgs				
	USE FOR	Safely Catch And Remove: Spiders, Roaches, Scorpions, Flies, Crickets, Stink Bugs, Millipedes, Centipedes, Wasps, Yellow Jackets, Bees, Moths And MoreInsects				

	NAME	Insect Catch Toogs			ITEM NO.:	HC3205
	SIZE	65x13.5x6cm			MATERIAL	ABS 250g
	COLOR	Sliver <input type="checkbox"/>	Red <input type="checkbox"/>	Blue <input type="checkbox"/>	Sliver <input type="checkbox"/>	
	PACKING	Bulk Pack <input type="checkbox"/>	White Box+Sticker <input type="checkbox"/>	Gift Box <input type="checkbox"/>	Head Card <input type="checkbox"/>	
	STANDARD	40Pcs/CTN, Measure: 73x34x47cm, G.W/N.W: 5/4kgs				
	USE FOR	Safely Catch And Remove: Spiders, Roaches, Scorpions, Flies, Crickets, Stink Bugs, Millipedes, Centipedes, Wasps, Yellow Jackets, Bees, Moths And MoreInsects				

	NAME	Insect Catch Toogs			ITEM NO.:	HC3205
	SIZE	65x13.5x6cm			MATERIAL	ABS 250g
	COLOR	Sliver <input type="checkbox"/>	Red <input type="checkbox"/>	Blue <input type="checkbox"/>	Sliver <input type="checkbox"/>	
	PACKING	Bulk Pack <input type="checkbox"/>	White Box+Sticker <input type="checkbox"/>	Gift Box <input type="checkbox"/>	Head Card <input type="checkbox"/>	
	STANDARD	40Pcs/CTN, Measure: 73x34x47cm, G.W/N.W: 5/4kgs				
	USE FOR	Safely Catch And Remove: Spiders, Roaches, Scorpions, Flies, Crickets, Stink Bugs, Millipedes, Centipedes, Wasps, Yellow Jackets, Bees, Moths And MoreInsects				







HC2119





HC2117





	NAME	Flies/Insect Trap Lamp	ITEM NO.:	HC5104
	SIZE	475.5x250x62mm	MATERIAL	Iron spraying <input type="checkbox"/> Stainless Steel <input type="checkbox"/>
	POWER	110V/240V 33W(2x15W)	CABLE TYPE	H05 RN 3X0.75M2,1.2M
	PLUG TYPE		COVE AREA	100M ²
	EXTRA SERVICE	Design For Customer <input type="checkbox"/>	OEM/ODM <input type="checkbox"/>	Develop New Item <input type="checkbox"/>
	STANDARD	1Pc/Box,4Boxes/Ctn		
	USE FOR	Suitable for manyplaces,for kinds of pests,safe and effective		

	NAME	Flies/Insect Trap Lamp	ITEM NO.:	HC5108
	SIZE	475.5x250x62mm	MATERIAL	Coated steel <input type="checkbox"/> Stainless Steel <input type="checkbox"/>
	POWER	110V/240V 33W(2x15W)	CABLE TYPE	H05 RN 3X0.75M2,1.2M
	PLUG TYPE		COVE AREA	100M ²
	EXTRA SERVICE	Design For Customer <input type="checkbox"/>	OEM/ODM <input type="checkbox"/>	Develop New Item <input type="checkbox"/>
	STANDARD	1Pc/Box,4Boxes/Ctn		
	USE FOR	Suitable for manyplaces,for kinds of pests,safe and effective		

	NAME	Flies/Insect Trap Lamp	ITEM NO.:	HC5105
	SIZE	475.5x250x62mm	MATERIAL	Coated steel <input type="checkbox"/> Stainless Steel <input type="checkbox"/>
	POWER	110V/240V 33W(2x15W)	CABLE TYPE	H05 RN 3X0.75M2,1.2M
	PLUG TYPE		COVE AREA	100M ²
	EXTRA SERVICE	Design For Customer <input type="checkbox"/>	OEM/ODM <input type="checkbox"/>	Develop New Item <input type="checkbox"/>
	STANDARD	1Pc/Box,4Boxes/Ctn		
	USE FOR	Suitable for manyplaces,for kinds of pests,safe and effective		

	NAME	Flies/Insect Trap Lamp	ITEM NO.:	HC5108S
	SIZE	480x195x220mm	MATERIAL	Coated steel <input type="checkbox"/> Stainless Steel <input type="checkbox"/>
	POWER	110V/240V 33W(2x15W)	CABLE TYPE	H05 RN 3X0.75M2,1.2M
	PLUG TYPE		COVE AREA	100M ²
	EXTRA SERVICE	Design For Customer <input type="checkbox"/>	OEM/ODM <input type="checkbox"/>	Develop New Item <input type="checkbox"/>
	STANDARD	1Pc/Box,4Boxes/Ctn		
	USE FOR	Suitable for manyplaces,for kinds of pests,safe and effective		

	NAME	Flies/Insect Trap Lamp	ITEM NO.:	HC5106
	SIZE	475.5x250x62mm	MATERIAL	Coated steel <input type="checkbox"/> Stainless Steel <input type="checkbox"/>
	POWER	110V/240V 33W(2x15W)	CABLE TYPE	H05 RN 3X0.75M2,1.2M
	PLUG TYPE		COVE AREA	100M ²
	EXTRA SERVICE	Design For Customer <input type="checkbox"/>	OEM/ODM <input type="checkbox"/>	Develop New Item <input type="checkbox"/>
	STANDARD	1Pc/Box,4Boxes/Ctn		
	USE FOR	Suitable for manyplaces,for kinds of pests,safe and effective		

	NAME	Flies/Insect Trap Lamp	ITEM NO.:	HC5110
	SIZE	480x195x220mm	MATERIAL	Coated steel <input type="checkbox"/> Stainless Steel <input type="checkbox"/>
	POWER	110V/240V 33W(2x15W)	CABLE TYPE	H05 RN 3X0.75M2,1.2M
	PLUG TYPE		COVE AREA	100M ²
	EXTRA SERVICE	Design For Customer <input type="checkbox"/>	OEM/ODM <input type="checkbox"/>	Develop New Item <input type="checkbox"/>
	STANDARD	1Pc/Box,4Boxes/Ctn		
	USE FOR	Suitable for manyplaces,for kinds of pests,safe and effective		

	NAME	Flies/insect Trap Lamp	ITEM NO.:	HC5107
	SIZE	475.5x250x62mm	MATERIAL	Coated steel <input type="checkbox"/> Stainless Steel <input type="checkbox"/>
	POWER	110V/240V 33W(2x15W)	CABLE TYPE	H05 RN 3X0.75M2,1.2M
	PLUG TYPE		COVE AREA	100M ²
	EXTRA SERVICE	Design For Customer <input type="checkbox"/>	OEM/ODM <input type="checkbox"/>	Develop New Item <input type="checkbox"/>
	STANDARD	1Pc/Box,4Boxes/Ctn		
	USE FOR	Suitable for manyplaces,for kinds of pests,safe and effective		

	NAME	Flies/Insect Trap Lamp	ITEM NO.:	HC5111
	SIZE	480x120x220mm	MATERIAL	Coated steel <input type="checkbox"/> Stainless Steel <input type="checkbox"/>
	POWER	110V/240V 33W(2x15W)	CABLE TYPE	H05 RN 3X0.75M2,1.2M
	PLUG TYPE		COVE AREA	100M ²
	EXTRA SERVICE	Design For Customer <input type="checkbox"/>	OEM/ODM <input type="checkbox"/>	Develop New Item <input type="checkbox"/>
	STANDARD	1Pc/Box,4Boxes/Ctn		
	USE FOR	Suitable for manyplaces,for kinds of pests,safe and effective		

	NAME	Flies/Insect Trap Lamp	ITEM NO.:	HC5107S
	SIZE	475.5x250x62mm	MATERIAL	Coated steel <input type="checkbox"/> Stainless Steel <input type="checkbox"/>
	POWER	110V/240V 33W(2x15W)	CABLE TYPE	H05 RN 3X0.75M2,1.2M
	PLUG TYPE		COVE AREA	100M ²
	EXTRA SERVICE	Design For Customer <input type="checkbox"/>	OEM/ODM <input type="checkbox"/>	Develop New Item <input type="checkbox"/>
	STANDARD	1Pc/Box,4Boxes/Ctn		
	USE FOR	Suitable for manyplaces,for kinds of pests,safe and effective		

	NAME	Flies/Insect Trap Lamp	ITEM NO.:	HC5112
	SIZE	475x180x145mm	MATERIAL	Coated steel <input type="checkbox"/> Stainless Steel <input type="checkbox"/>
	POWER	110V/240V 33W(2x15W)	CABLE TYPE	H05 RN 3X0.75M2,1.2M
	PLUG TYPE		COVE AREA	100M ²
	EXTRA SERVICE	Design For Customer <input type="checkbox"/>	OEM/ODM <input type="checkbox"/>	Develop New Item <input type="checkbox"/>
	STANDARD	1Pc/Box,4Boxes/Ctn		
	USE FOR	Suitable for manyplaces,for kinds of pests,safe and effective		







	NAME	Flies/Insect Trap Lamp	ITEM NO.:	HC5115
	SIZE	575.5x250x62mm	MATERIAL	Coated steel <input type="checkbox"/> Stainless Steel <input type="checkbox"/>
	POWER	110V/240V 33W(2x15W)	CABLE TYPE	H05 RN 3X0.75M2,1.2M
	PLUG TYPE		COVE AREA	100M ²
	EXTRA SERVICE	Design For Customer <input type="checkbox"/>	OEM/ODM	Develop New Item <input type="checkbox"/>
	STANDARD	1Pc/Box,4Boxes/Ctn		
	USE FOR	Suitable for manyplaces,for kinds of pests,safe and effective		

	NAME	Flies/Insect Trap Lamp	ITEM NO.:	HC5116
	SIZE	230x100x310mm	MATERIAL	Iron spraying <input type="checkbox"/> Stainless Steel <input type="checkbox"/>
	POWER	110V/240V 33W(2x15W)	CABLE TYPE	H05 RN 3X0.75M2,1.2M
	PLUG TYPE		COVE AREA	100M ²
	EXTRA SERVICE	Design For Customer <input type="checkbox"/>	OEM/ODM	Develop New Item <input type="checkbox"/>
	STANDARD	1Pc/Box,4Boxes/Ctn		
	USE FOR	Suitable for manyplaces,for kinds of pests,safe and effective		

	NAME	Flies/Insect Trap Lamp	ITEM NO.:	HC5117
	SIZE	475.5x250x62mm	MATERIAL	Coated steel <input type="checkbox"/> Stainless Steel <input type="checkbox"/>
	POWER	110V/240V 33W(2x15W)	CABLE TYPE	H05 RN 3X0.75M2,1.2M
	PLUG TYPE		COVE AREA	100M ²
	EXTRA SERVICE	Design For Customer <input type="checkbox"/>	OEM/ODM	Develop New Item <input type="checkbox"/>
	STANDARD	1Pc/Box,4Boxes/Ctn		
	USE FOR	Suitable for manyplaces,for kinds of pests,safe and effective		

	NAME	Flies/insect Trap Lamp	ITEM NO.:	HC5118
	SIZE	475.5x250x62mm	MATERIAL	Coated steel <input type="checkbox"/> Stainless Steel <input type="checkbox"/>
	POWER	110V/240V 33W(2x15W)	CABLE TYPE	H05 RN 3X0.75M2,1.2M
	PLUG TYPE		COVE AREA	100M ²
	EXTRA SERVICE	Design For Customer <input type="checkbox"/>	OEM/ODM	Develop New Item <input type="checkbox"/>
	STANDARD	1Pc/Box,4Boxes/Ctn		
	USE FOR	Suitable for manyplaces,for kinds of pests,safe and effective		

	NAME	Flies/Insect Trap Lamp	ITEM NO.:	HC5105P
	SIZE	475.5x250x62mm	MATERIAL	Coated steel <input type="checkbox"/> Stainless Steel <input type="checkbox"/>
	POWER	110V/240V 33W(2x15W)	CABLE TYPE	H05 RN 3X0.75M2,1.2M
	PLUG TYPE		COVE AREA	100M ²
	EXTRA SERVICE	Design For Customer <input type="checkbox"/>	OEM/ODM	Develop New Item <input type="checkbox"/>
	STANDARD	1Pc/Box,4Boxes/Ctn		
	USE FOR	Suitable for manyplaces,for kinds of pests,safe and effective		

	NAME	Flies/Insect Glue Trap/Mosquito	ITEM NO.:	HC4612
	SIZE	260x110x26mm	MATERIAL	PP 116g
	POWER	3.7V Rechargeable	CABLE TYPE	USB
	PLUG TYPE	USB	COVE AREA	20m ²
	EXTRA SERVICE	Design For Customer <input type="checkbox"/>	OEM/ODM	Develop New Item <input type="checkbox"/>
	STANDARD			
	USE FOR	Catch files ,mosquitoes,etc		

	NAME	Flea Lamp/Bed Bug Trap	ITEM NO.:	HC4614
	SIZE	Φ220x90mm	MATERIAL	PP 246g
	POWER	220V	CABLE TYPE	18AwgX2C
	PLUG TYPE		COVE AREA	
	EXTRA SERVICE	Design For Customer <input type="checkbox"/>	OEM/ODM	Develop New Item <input type="checkbox"/>
	STANDARD	One Trap with 15 ticker+ 2bulb		
	USE FOR	Catch fleas, can be placed in the kennel		

	NAME	Flea Lamp(LED)/Bed Bug Trap	ITEM NO.:	HC4614S
	SIZE	Φ220x90mm	MATERIAL	PP 246g
	POWER	3.7V	CABLE TYPE	
	PLUG TYPE		COVE AREA	
	EXTRA SERVICE	Design For Customer <input type="checkbox"/>	OEM/ODM	Develop New Item <input type="checkbox"/>
	STANDARD	One Trap with 1 sticker		
	USE FOR	Catch fleas, can be placed in the kennel		

	NAME	Flea Lamp/Bed Bug Trap	ITEM NO.:	HC4615
	SIZE	Φ230x90mm	MATERIAL	PP 265g
	POWER	220V	CABLE TYPE	
	PLUG TYPE	USB	COVE AREA	40m ²
	EXTRA SERVICE	Design For Customer <input type="checkbox"/>	OEM/ODM	Develop New Item <input type="checkbox"/>
	STANDARD			
	USE FOR	Catch fleas, can be placed in the kennel		

	NAME	Flea Lamp(LED)/Bed Bug Trap	ITEM NO.:	HC4615S
	SIZE	Φ23 v0x90mm	MATERIAL	PP 246g
	POWER	3.7V	CABLE TYPE	
	PLUG TYPE		COVE AREA	
	EXTRA SERVICE	Design For Customer <input type="checkbox"/>	OEM/ODM	Develop New Item <input type="checkbox"/>
	STANDARD			
	USE FOR	Catch fleas, can be placed in the kennel		





Insect control



Insect Control

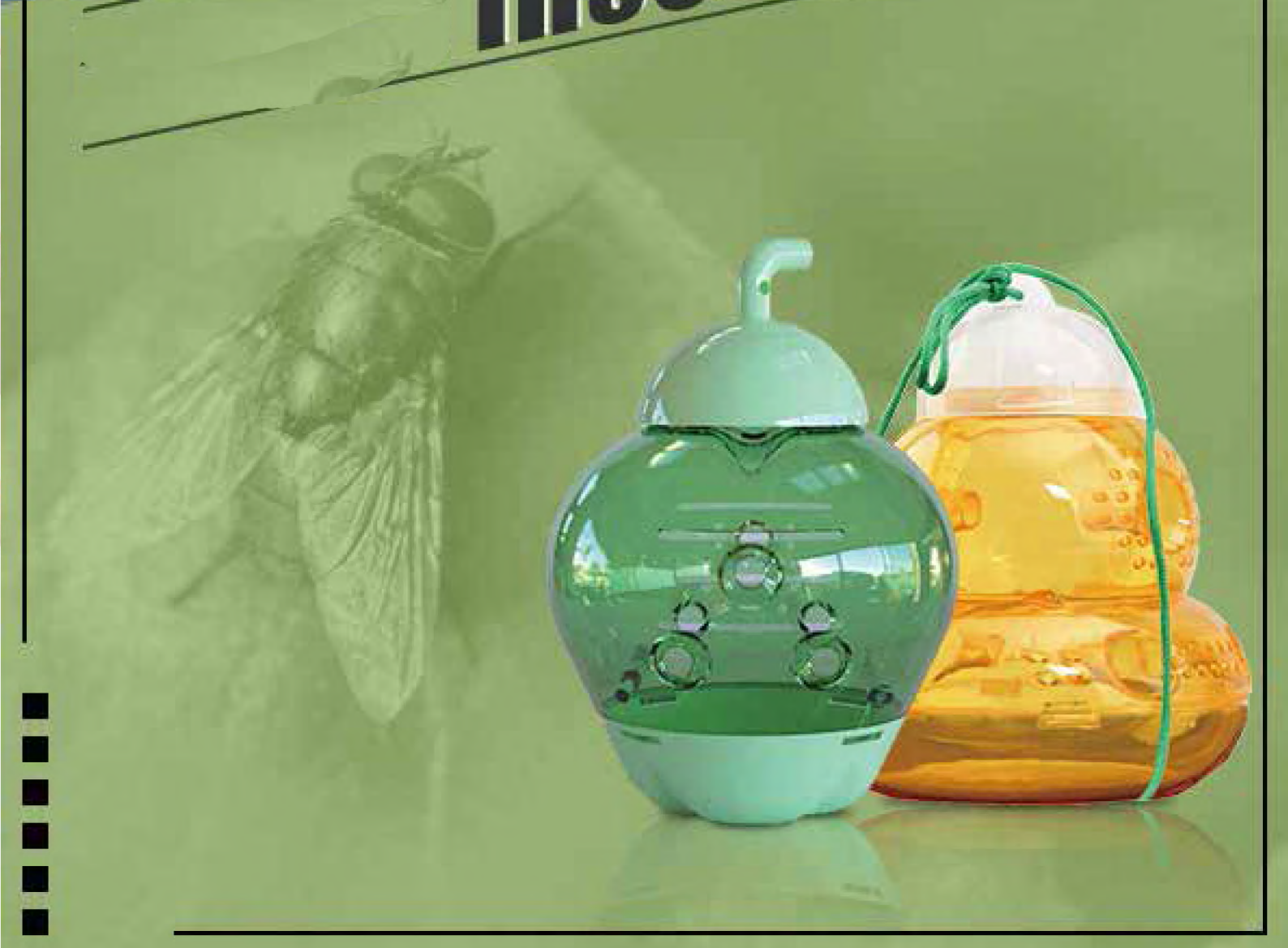



Insect control





Insect Control

	NAME	Easy Flies Trap Bag	ITEM NO.:	HC4215N1
	SIZE	S: 21x21cm <input type="checkbox"/> 40.5g	B: 21x28cm <input type="checkbox"/>	L: 21x40cm <input type="checkbox"/>
	MATERIAL	PP+PET	Attraction Bait <input type="checkbox"/>	Lifting Rope <input type="checkbox"/>
	OEM/ODM	Factory Brand Design <input type="checkbox"/>	No Brand Design <input type="checkbox"/>	Customer Own Design <input type="checkbox"/>
	EXTRA SERVICE	Design For Customer <input type="checkbox"/>	Suggestions <input type="checkbox"/>	Develop New Item <input type="checkbox"/>
	PACKING	Bulk Pack <input type="checkbox"/>	White Box+sticker <input type="checkbox"/>	Gift Box <input type="checkbox"/>
	STANDARD	100Pcs/Ctn, Measure: 53x39x35cm, G.W/N.W:6/5kgs		
	USE FOR	Catching Flies, Safe And Non-Toxic, Easy To Use And Sanitary.		

	NAME	Haierc Flies Trap Bag	ITEM NO.:	HC4215S
	SIZE	S: 21x21cm <input type="checkbox"/> 40.5g	B: 21x28cm <input type="checkbox"/>	L: 21x40cm <input type="checkbox"/>
	MATERIAL	PP+PET	Attraction Bait <input type="checkbox"/>	Lifting Rope <input type="checkbox"/>
	OEM/ODM	Factory Brand Design <input type="checkbox"/>	No Brand Design <input type="checkbox"/>	Customer Own Design <input type="checkbox"/>
	EXTRA SERVICE	Design For Customer <input type="checkbox"/>	Suggestions <input type="checkbox"/>	Develop New Item <input type="checkbox"/>
	PACKING	Bulk Pack <input type="checkbox"/>	White Box+sticker <input type="checkbox"/>	Gift Box <input type="checkbox"/>
	STANDARD	100Pcs/Ctn, Measure: 53x39x35cm, G.W/N.W:6/5kgs		
	USE FOR	Catching Flies, Safe And Non-Toxic, Easy To Use And Sanitary.		

	NAME	Haierc Bigger Flies Trap Bag	ITEM NO.:	HC4215B
	SIZE	S: 21x21cm <input type="checkbox"/> 60g	B: 21x28cm <input type="checkbox"/>	L: 21x40cm <input type="checkbox"/>
	MATERIAL	PP+PET	ATTRACTION BAIT <input type="checkbox"/>	LIFTING ROPE <input type="checkbox"/>
	OEM/ODM	Factory Brand Design <input type="checkbox"/>	No Brand Design <input type="checkbox"/>	Customer Own Design <input type="checkbox"/>
	EXTRA SERVICE	Design For Customer <input type="checkbox"/>	Suggestions <input type="checkbox"/>	Develop New Item <input type="checkbox"/>
	PACKING	Bulk Pack <input type="checkbox"/>	White Box+sticker <input type="checkbox"/>	Gift Box <input type="checkbox"/>
	STANDARD	100Pcs/Ctn, Measure: 53x39x35cm, G.W/N.W:7/6kgs		
	USE FOR	Catching Flies, Safe And Non-Toxic, Easy To Use And Sanitary.		

	NAME	Haierc TV Flies Trap Bag	ITEM NO.:	HC4242
	SIZE	20x32cm 148g		
	MATERIAL	PP+PET	attraction Bait <input type="checkbox"/>	Lifting Rope <input type="checkbox"/>
	OEM/ODM	Factory Brand Design <input type="checkbox"/>	No Brand Design <input type="checkbox"/>	Customer Own Design <input type="checkbox"/>
	EXTRA SERVICE	Design For Customer <input type="checkbox"/>	Suggestions <input type="checkbox"/>	Develop New Item <input type="checkbox"/>
	PACKING	Bulk Pack <input type="checkbox"/>	White Box+sticker <input type="checkbox"/>	Gift Box <input type="checkbox"/>
	STANDARD	100Pcs/Ctn, Measure: 50x25x25cm, G.W/N.W:16/15kgs		
	USE FOR	Catching Flies, Safe And Non-Toxic, Easy To Use And Sanitary.		

	NAME	Pro Haierc Flies Trap Bag	ITEM NO.:	HC4245
	SIZE	S: 21x21cm <input type="checkbox"/> 40.5g	B: 21x28cm <input type="checkbox"/>	L: 21x40cm <input type="checkbox"/>
	MATERIAL	PP+PET	Attraction Bait <input type="checkbox"/>	Lifting Rope <input type="checkbox"/>
	OEM/ODM	Factory Brand Design <input type="checkbox"/>	No Brand Design <input type="checkbox"/>	Customer Own Design <input type="checkbox"/>
	EXTRA SERVICE	Design For Customer <input type="checkbox"/>	Suggestions <input type="checkbox"/>	Develop New Item <input type="checkbox"/>
	PACKING	Bulk Pack <input type="checkbox"/>	White Box+sticker <input type="checkbox"/>	Gift Box <input type="checkbox"/>
	STANDARD	100Pcs/Ctn, Measure: 53x39x35cm, G.W/N.W:6/5kgs		
	USE FOR	Catching Flies, Safe And Non-Toxic, Easy To Use And Sanitary.		





	NAME	Pro Haierc Flies Trap Bag	ITEM NO.:	HC4243
	SIZE	S: 21x21cm <input type="checkbox"/>	B: 21x28cm <input type="checkbox"/>	L: 21x40cm 142g
	MATERIAL	PP+PET	Attraction Bait <input type="checkbox"/>	Lifting Rope <input type="checkbox"/>
	OEM/ODM	Factory Brand Design <input type="checkbox"/>	No Brand Design <input type="checkbox"/>	Customer Own Design <input type="checkbox"/>
	EXTRA SERVICE	Design For Customer <input type="checkbox"/>	Suggestions <input type="checkbox"/>	Develop New Item <input type="checkbox"/>
	PACKING	Bulk Pack <input type="checkbox"/>	White Box+sticker <input type="checkbox"/>	Gift Box <input type="checkbox"/>
	STANDARD	50Pcs/Ctn, Measure:54.5x36.5x58.5cm, G.W/N.W:8.1/7.1kgs		
	USE FOR	Catching Flies, Safe And Non-toxic, Easy To Use, Effective.		

	NAME	Fly Trap Bottle	ITEM NO.:	HC4239
	SIZE	S: <input type="checkbox"/> Φ8x24cm 76.5g	L: Φ12x28cm	
	MATERIAL	PP+PET	Attraction Bait <input type="checkbox"/>	Lifting Rope <input type="checkbox"/>
	OEM/ODM	Factory Brand Design <input type="checkbox"/>	No Brand Design <input type="checkbox"/>	Customer Own Design <input type="checkbox"/>
	EXTRA SERVICE	Design For Customer <input type="checkbox"/>	Suggestions <input type="checkbox"/>	Develop New Item <input type="checkbox"/>
	PACKING	Bulk Pack <input type="checkbox"/>	White Box+sticker <input type="checkbox"/>	Gift Box <input type="checkbox"/>
	STANDARD	20Pcs/Ctn, Measure:48.5x38.5x23.5cm, G.W/N.W:2/1.5kgs		
	USE FOR	Orchard, Greenhouse, Farm Field, Forest, Fruit Garden		

	NAME	Easy Flies Trap Bag	ITEM NO.:	HC4215N2
	SIZE	S: 21x21cm <input type="checkbox"/> 40.5g	B: 21x28cm <input type="checkbox"/>	L: 21x40cm
	MATERIAL	PP+PET	Attraction Bait <input type="checkbox"/>	Lifting Rope <input type="checkbox"/>
	OEM/ODM	Factory Brand Design <input type="checkbox"/>	No Brand Design <input type="checkbox"/>	Customer Own Design <input type="checkbox"/>
	EXTRA SERVICE	Design For Customer <input type="checkbox"/>	Suggestions <input type="checkbox"/>	Develop New Item <input type="checkbox"/>
	PACKING	Bulk Pack <input type="checkbox"/>	White Box+sticker <input type="checkbox"/>	Gift Box <input type="checkbox"/>
	STANDARD	100Pcs/Ctn, Measure: 53x39x35cm, G.W/N.W:6/5kgs		
	USE FOR	Catching Flies, Safe And Non-toxic, Easy To Use, Effective.		

	NAME	Pro Fly Trap Bottle	ITEM NO.:	HC4238
	SIZE	S: <input type="checkbox"/> Φ7.5x24.5cm 97g	L: <input type="checkbox"/> Φ12x30cm 137g	
	MATERIAL	PP+PET	Attraction Bait <input type="checkbox"/>	Lifting Rope <input type="checkbox"/>
	OEM/ODM	Factory Brand Design <input type="checkbox"/>	No Brand Design <input type="checkbox"/>	Customer Own Design <input type="checkbox"/>
	EXTRA SERVICE	Design For Customer <input type="checkbox"/>	Suggestions <input type="checkbox"/>	Develop New Item <input type="checkbox"/>
	PACKING	Bulk Pack <input type="checkbox"/>	White Box+sticker <input type="checkbox"/>	Gift Box <input type="checkbox"/>
	STANDARD	162Pcs/Ctn, Measure:83x54x60 cm, G.W/N.W:17.16/16.16kgs(Φ7.5x24.5cm)		
	USE FOR	Attracts Flies, Fruit Flies, Reusable, Easy To Use, Eco-friendly		

	NAME	Easy Flies Trap Bag	ITEM NO.:	HC4215N3
	SIZE	S: 21x21cm <input type="checkbox"/> 40.5g	B: 21x28cm <input type="checkbox"/>	L: 21x40cm
	MATERIAL	PP+PET	Attraction Bait <input type="checkbox"/>	Lifting Rope <input type="checkbox"/>
	OEM/ODM	Factory Brand Design <input type="checkbox"/>	No Brand Design <input type="checkbox"/>	Customer Own Design <input type="checkbox"/>
	EXTRA SERVICE	Design For Customer <input type="checkbox"/>	Suggestions <input type="checkbox"/>	Develop New Item <input type="checkbox"/>
	PACKING	Bulk Pack <input type="checkbox"/>	White Box+sticker <input type="checkbox"/>	Gift Box <input type="checkbox"/>
	STANDARD	100Pcs/Ctn, Measure: 53x39x35cm, G.W/N.W:6/5kgs		
	USE FOR	Catching Flies, Safe And Non-toxic, Easy To Use, Effective.		

	NAME	Fly Trap Bottle	ITEM NO.:	HC4237
	SIZE	S: <input type="checkbox"/> Φ8x20cm 66g	L: <input type="checkbox"/> Φ12x28cm 118g	
	MATERIAL	PP+PET	Attraction Bait <input type="checkbox"/>	Lifting Rope <input type="checkbox"/>
	OEM/ODM	Factory Brand Design <input type="checkbox"/>	No Brand Design <input type="checkbox"/>	Customer Own Design <input type="checkbox"/>
	EXTRA SERVICE	Design For Customer <input type="checkbox"/>	Suggestions <input type="checkbox"/>	Develop New Item <input type="checkbox"/>
	PACKING	Bulk Pack <input type="checkbox"/>	White Box+sticker <input type="checkbox"/>	Gift Box <input type="checkbox"/>
	STANDARD	100Pcs/CTN, Measure:87.5x44.5x38cm, G.W/N.W:9.5/8kgs (Φ8x20cm)		
	USE FOR	Attracts Flies, Reusable, Easy To Use		

	NAME	Japan Beetle Trap	ITEM NO.:	HC4241
	SIZE	10x28cm		
	MATERIAL	PP+PET	attraction Bait <input type="checkbox"/>	Lifting Rope <input type="checkbox"/>
	OEM/ODM	Factory Brand Design <input type="checkbox"/>	No Brand Design <input type="checkbox"/>	Customer Own Design <input type="checkbox"/>
	EXTRA SERVICE	Design For Customer <input type="checkbox"/>	Suggestions <input type="checkbox"/>	Develop New Item <input type="checkbox"/>
	PACKING	Bulk Pack <input type="checkbox"/>	White Box+sticker <input type="checkbox"/>	Gift Box <input type="checkbox"/>
	STANDARD	100Pcs/Ctn, Measure: 53x39x 35cm, G.W/N.W:5/4kgs		
	USE FOR	Catching Flies, Safe And Non-toxic, Easy To Use, Effective.		

	NAME	Pro Fly Trap Bottle	ITEM NO.:	HC4236
	SIZE	Φ9x23cm		
	MATERIAL	PP+PET	attraction Bait <input type="checkbox"/>	Lifting Rope <input type="checkbox"/>
	OEM/ODM	Factory Brand Design <input type="checkbox"/>	No Brand Design <input type="checkbox"/>	Customer Own Design <input type="checkbox"/>
	EXTRA SERVICE	Design For Customer <input type="checkbox"/>	Suggestions <input type="checkbox"/>	Develop New Item <input type="checkbox"/>
	PACKING	Bulk Pack <input type="checkbox"/>	White Box+sticker <input type="checkbox"/>	Gift Box <input type="checkbox"/>
	STANDARD	40pcs/CTN, Measure:50x40x60cm, G.W/N.W:7.7/6.7kgs		
	USE FOR	Attracts Flies, Reusable, Easy To Use, Big Cap Make It Water Proof.		

	NAME	Horsefly Trap Machine	ITEM NO.:	HC4240
	SIZE	19x120cm		
	MATERIAL	PVC+STEEL+PP	attraction Bait <input type="checkbox"/>	Lifting Rope <input type="checkbox"/>
	OEM/ODM	Factory Brand Design <input type="checkbox"/>	No Brand Design <input type="checkbox"/>	Customer Own Design <input type="checkbox"/>
	EXTRA SERVICE	Design For Customer <input type="checkbox"/>	Suggestions <input type="checkbox"/>	Develop New Item <input type="checkbox"/>
	PACKING	Bulk Pack <input type="checkbox"/>	White Box+sticker <input type="checkbox"/>	Gift Box <input type="checkbox"/>
	STANDARD			
	USE FOR	Catching Horsefly, Safe And Non-toxic, Easy To Use, Effective.		

	NAME	Pro Fly Trap Bottle	ITEM NO.:	HC4235
	SIZE	23.5x15.5cm 103g		
	MATERIAL	PP+PET	attraction Bait <input type="checkbox"/>	Lifting Rope <input type="checkbox"/>
	OEM/ODM	Factory Brand Design <input type="checkbox"/>	No Brand Design <input type="checkbox"/>	Customer Own Design <input type="checkbox"/>
	EXTRA SERVICE	Design For Customer <input type="checkbox"/>	Suggestions <input type="checkbox"/>	Develop New Item <input type="checkbox"/>
	PACKING	Bulk Pack <input type="checkbox"/>	White Box+sticker <input type="checkbox"/>	Gift Box <input type="checkbox"/>
	STANDARD	24Pcs/CTN, Measure:46x24x34cm, G.W3/N.W:3/2.5kgs		
	USE FOR	Attracts Flies, Modern Design, Reusable, Easy To Use		





	NAME	Yellow Jacket/Wasp Trap Bag	ITEM NO.:	HC4702
	SIZE	S: 21x21cm <input type="checkbox"/> 40.5g	B: 21x28cm <input type="checkbox"/>	L: 21x40cm <input type="checkbox"/>
	MATERIAL	PP+PET	Attraction Bait <input type="checkbox"/>	Lifting Rope <input type="checkbox"/>
	OEM/ODM	Factory Brand Design <input type="checkbox"/>	No Brand Design <input type="checkbox"/>	Customer Own Design <input type="checkbox"/>
	EXTRA SERVICE	Design For Customer <input type="checkbox"/>	Suggestions <input type="checkbox"/>	Develop New Item <input type="checkbox"/>
	PACKING	Bulk Pack <input type="checkbox"/>	White Box+sticker <input type="checkbox"/>	Gift Box <input type="checkbox"/>
	STANDARD	100pcs/Ctn, Measure: 53x39x35cm, G.W/N.W:6/5kgs		
	USE FOR	1, Put Water Inside After Two or Three Days It Will Start To Attract The Wasp 2, Or Add Orange Juice Directly To Catch Wasp		

	NAME	New Yellow Jacket/Wasp Trap	ITEM NO.:	HC4705
	SIZE	15.5x12.5x12.5cm		
	MATERIAL	PP+PET 190/box	Attraction Bait <input type="checkbox"/>	Lifting Rope <input type="checkbox"/>
	OEM/ODM	Factory Brand Design <input type="checkbox"/>	No Brand Design <input type="checkbox"/>	Customer Own Design <input type="checkbox"/>
	EXTRA SERVICE	Design For Customer <input type="checkbox"/>	Suggestions <input type="checkbox"/>	Develop New Item <input type="checkbox"/>
	PACKING	Bulk Pack <input type="checkbox"/>	White Box+Sticker <input type="checkbox"/>	Gift Box <input type="checkbox"/>
	STANDARD	1Pc/Box,48Box/Ctn, Measure: 56x56x40.5cm, G.W/N.W:10.12/9.12kgs		
	USE FOR	Catch Bees, Flies, Hornets, Mosquitoes.Lightweight,Multiple Entry, Waterproof		

	NAME	Yellow Jacket/Wasp Trap Bag	ITEM NO.:	HC4702S
	SIZE	S: 21x21cm <input type="checkbox"/> 40.5g	B: 21x28cm <input type="checkbox"/>	L: 21x40cm <input type="checkbox"/>
	MATERIAL	PP+PET	Attraction Bait <input type="checkbox"/>	Lifting Rope <input type="checkbox"/>
	OEM/ODM	Factory Brand Design <input type="checkbox"/>	No Brand Design <input type="checkbox"/>	Customer Own Design <input type="checkbox"/>
	EXTRA SERVICE	Design For Customer <input type="checkbox"/>	Suggestions <input type="checkbox"/>	Develop New Item <input type="checkbox"/>
	PACKING	Bulk Pack <input type="checkbox"/>	White Box+sticker <input type="checkbox"/>	Gift Box <input type="checkbox"/>
	STANDARD	100Pcs/Ctn, Measure: 53x39x35cm, G.W/N.W:6/5kgs		
	USE FOR	1, Put Water Inside After Two or Three Days It Will Start To Attract The Wasp 2, Or Add Orange Juice Directly To Catch Wasp		

	NAME	Yellow Jacket/Wasp Trap	ITEM NO.:	HC4706
	SIZE	15.5x12.5x12.5cm		
	MATERIAL	PP+PET 180g /box	Attraction Bait <input type="checkbox"/>	Lifting Rope <input type="checkbox"/>
	OEM/ODM	Factory Brand Design <input type="checkbox"/>	No Brand Design <input type="checkbox"/>	Customer Own Design <input type="checkbox"/>
	EXTRA SERVICE	Design For Customer <input type="checkbox"/>	Suggestions <input type="checkbox"/>	Develop New Item <input type="checkbox"/>
	PACKING	Bulk Pack <input type="checkbox"/>	White Box+Sticker <input type="checkbox"/>	Gift Box <input type="checkbox"/>
	STANDARD	48pcs/CTN, Measure: 56x56x40.5cm, G.W/N.W:9.64/8.64kgs		
	USE FOR	Catch Bees, Flies, Hornets, Mosquitoes.Lightweight,Multiple Entry, Waterproof		

	NAME	Bee & Wasp & Moth Trap	ITEM NO.:	HC4203
	SIZE	Φ16×22cm		
	MATERIAL	PP+PET 233g	attraction Bait <input type="checkbox"/>	Lifting Rope <input type="checkbox"/>
	OEM/ODM	Factory Brand Design <input type="checkbox"/>	No Brand Design <input type="checkbox"/>	Customer Own Design <input type="checkbox"/>
	EXTRA SERVICE	Design For Customer <input type="checkbox"/>	Suggestions <input type="checkbox"/>	Develop New Item <input type="checkbox"/>
	PACKING	Bulk Pack <input type="checkbox"/>	White Box+sticker <input type="checkbox"/>	Gift Box <input type="checkbox"/>
	STANDARD	25Pcs/Ctn Measure:62.5x34x32.5cm, G.W/N.W:7/6kgs		
	USE FOR	Add Orange Juice Directly. To catch wasp		

	NAME	Solar Yellow Jacket/Wasp Trap	ITEM NO.:	HC4704S
	SIZE	Φ9x13.5cm		
	MATERIAL	PVC+STEEL+PP 100g	Attraction Bait <input type="checkbox"/>	Lifting Rope <input type="checkbox"/>
	OEM/ODM	Factory Brand Design <input type="checkbox"/>	No Brand Design <input type="checkbox"/>	Customer Own Design <input type="checkbox"/>
	EXTRA SERVICE	Design For Customer <input type="checkbox"/>	Suggestions <input type="checkbox"/>	Develop New Item <input type="checkbox"/>
	PACKING	Bulk Pack <input type="checkbox"/>	white Box+Sticker <input type="checkbox"/>	Gift Box <input type="checkbox"/>
	STANDARD	2Pcs/Box, 24Pcs/Ctn, Measure:40.5x31x30cm, G.W/N.W:3.8/3.1kgs		
	USE FOR	A device powered by solar energy, attracting bees,wasp effectively By adding some juice,beer etc into the device, the pests can be trapped better		

	NAME	Bee & Wasp & Moth Trap	ITEM NO.:	HC4203S
	SIZE	Φ16×32cm		
	MATERIAL	PP+PET	attraction Bait <input type="checkbox"/>	Lifting Rope <input type="checkbox"/>
	OEM/ODM	Factory Brand Design <input type="checkbox"/>	No Brand Design <input type="checkbox"/>	Customer Own Design <input type="checkbox"/>
	EXTRA SERVICE	Design For Customer <input type="checkbox"/>	Suggestions <input type="checkbox"/>	Develop New Item <input type="checkbox"/>
	PACKING	Bulk Pack <input type="checkbox"/>	White Box+sticker <input type="checkbox"/>	Gift Box <input type="checkbox"/>
	STANDARD	25Pcs/Ctn Measure:62.5x34x32.5cm, G.W/N.W:8.1/7.1kgs		
	USE FOR	Add Orange Juice directly. To catch wasp		

	NAME	Yellow Jacket/Wasp Proof Nest	ITEM NO.:	HC4707
	SIZE	21x28cm		
	MATERIAL	Oil Paper 28g		
	OEM/ODM	Factory Brand Design <input type="checkbox"/>	No Brand Design <input type="checkbox"/>	Customer Own Design <input type="checkbox"/>
	EXTRA SERVICE	Design For Customer <input type="checkbox"/>	Suggestions <input type="checkbox"/>	Develop New Item <input type="checkbox"/>
	PACKING	Bulk Pack <input type="checkbox"/>	white Box+Sticker <input type="checkbox"/>	Gift Box <input type="checkbox"/>
	STANDARD	500Pcs/Ctn, Measure: 45x45x45cm G.W/N.W:15/14kgs		
	USE FOR	Expelling wasps,Effective Visual Deterrent,Non-Toxic, Chemical -Free,Easy To Deploy,Perfect No-Kill		

	NAME	Yellow Jacket/Wasp Trap	ITEM NO.:	HC4704
	SIZE	Φ9x13.5cm		
	MATERIAL	P+PET 68g		
	OEM/ODM	Factory Brand Design <input type="checkbox"/>	No Brand Design <input type="checkbox"/>	Customer Own Design <input type="checkbox"/>
	EXTRA SERVICE	Design For Customer <input type="checkbox"/>	Suggestions <input type="checkbox"/>	Develop New Item <input type="checkbox"/>
	PACKING	Bulk Pack <input type="checkbox"/>	White Box+sticker <input type="checkbox"/>	Gift Box <input type="checkbox"/>
	STANDARD	2Pcs/White Box,24Pcs/Ctn, Measure:40.5x31x30cm, G.W/N.W:3.2/2.5kgs		
	USE FOR	Add Orange Juice directly. To catch wasp		

	NAME	Yellow Jacket/Wasp Proof Nest	ITEM NO.:	HC4708
	SIZE	21x28cm		
	MATERIAL	Special Cloth		
	OEM/ODM	Factory Brand Design <input type="checkbox"/>	No Brand Design <input type="checkbox"/>	Customer Own Design <input type="checkbox"/>
	EXTRA SERVICE	Design For Customer <input type="checkbox"/>	Suggestions <input type="checkbox"/>	Develop New Item <input type="checkbox"/>
	PACKING	Bulk Pack <input type="checkbox"/>	white Box+Sticker <input type="checkbox"/>	Gift Box <input type="checkbox"/>
	STANDARD	1Pc/Box,120Box/Ctn, Measure:43x44x39cm		
	USE FOR	Expelling Wasps,Effective Visual Deterrent,Non-Toxic, Chemical -Free,Easy To Deploy,Perfect No-Kill		





	NAME	Fly Trap Bottle	ITEM NO.:	HC4216
	SIZE	Φ8x24CM 93g		
	MATERIAL	PP+PET	attraction Bait <input type="checkbox"/>	Lifting Rope <input type="checkbox"/>
	OEM/ODM	Factory Brand Design <input type="checkbox"/>	No Brand Design <input type="checkbox"/>	Customer Own Design <input type="checkbox"/>
	EXTRA SERVICE	Design For Customer <input type="checkbox"/>	Suggestions <input type="checkbox"/>	Develop New Item <input type="checkbox"/>
	PACKING	Bulk Pack <input type="checkbox"/>	White Box+sticker <input type="checkbox"/>	Gift Box <input type="checkbox"/>
	STANDARD	20Pcs/Ctn, Measure:48.5x38.5x23.5cm, G.W/N.W:2.5/2kgs		
	USE FOR	For Mass Trapping Bactrocera Cucurbitae (Melon Fly), Bactrocera Dorsalis (Oriental Fruit Fly), etc. Used In Orchard, Greenhouse, Farm Field, Forest, Fruit Garden		

 Bottle not included	NAME	Fly Trap Bottle	ITEM NO.:	HC4231
	SIZE			
	MATERIAL	PP+PET	attraction Bait <input type="checkbox"/>	Lifting Rope <input type="checkbox"/>
	OEM/ODM	Factory Brand Design <input type="checkbox"/>	No Brand Design <input type="checkbox"/>	Customer Own Design <input type="checkbox"/>
	EXTRA SERVICE	Design For Customer <input type="checkbox"/>	Suggestions <input type="checkbox"/>	Develop New Item <input type="checkbox"/>
	PACKING	Bulk Pack <input type="checkbox"/>	White Box+sticker <input type="checkbox"/>	Gift Box <input type="checkbox"/>
	STANDARD			
	USE FOR			

	NAME	Fruit Fly Trap	ITEM NO.:	HC4232
	SIZE	8x12cm		
	MATERIAL	PP+PET	attraction Bait <input type="checkbox"/>	Lifting Rope <input type="checkbox"/>
	OEM/ODM	Factory Brand Design <input type="checkbox"/>	No Brand Design <input type="checkbox"/>	Customer Own Design <input type="checkbox"/>
	EXTRA SERVICE	Design For Customer <input type="checkbox"/>	Suggestions <input type="checkbox"/>	Develop New Item <input type="checkbox"/>
	PACKING	Bulk Pack <input type="checkbox"/>	White Box+sticker <input type="checkbox"/>	Gift Box <input type="checkbox"/>
	STANDARD			
	USE FOR			

	NAME	Industry Fly Trap Box	ITEM NO.:	HC4234
	SIZE	39x51.5cm		
	MATERIAL	ABS+AL+PP	attraction Bait <input type="checkbox"/>	Lifting Rope <input type="checkbox"/>
	OEM/ODM	Factory Brand Design <input type="checkbox"/>	No Brand Design <input type="checkbox"/>	Customer Own Design <input type="checkbox"/>
	EXTRA SERVICE	Design For Customer <input type="checkbox"/>	Suggestions <input type="checkbox"/>	Develop New Item <input type="checkbox"/>
	PACKING	Bulk Pack <input type="checkbox"/>	White Box+sticker <input type="checkbox"/>	Gift Box <input type="checkbox"/>
	STANDARD			
	USE FOR			

	NAME	Fly Trap Attraction Bait	ITEM NO.:	HC4401	
	MATERIAL	Natural Food Grade Material			
	WEIGHT	8g, 15g, 25g, 30g, 40g, 60g for choose			
	PACKING	Bulk Pack <input type="checkbox"/>	white Box+sticker <input type="checkbox"/>	Gift Box <input type="checkbox"/>	Head Card <input type="checkbox"/>
	STANDARD				
	USE FOR	Strong Attraction, Good Palatability, Easy To Use And Harmless To Human, Animals And Environment.			

	NAME	Fly Trap Attraction Bait	ITEM NO.:	HC4402	
	MATERIAL	Natural Food Grade Material			
	WEIGHT	200g, 1000g, 2.5kgs			
	PACKING	Bulk Pack <input type="checkbox"/>	white Box+sticker <input type="checkbox"/>	Gift Box <input type="checkbox"/>	Head Card <input type="checkbox"/>
	STANDARD				
	USE FOR	Strong Attraction, Good Palatability, Easy To Use And Harmless To Human, Animals And Environment.			

	NAME	Fruit Fly Trap Attraction Bait	ITEM NO.:	HC4403	
	MATERIAL	Natural Food Grade Material			
	WEIGHT	60ml, 1000ml for choose			
	PACKING	Bulk Pack <input type="checkbox"/>	white Box+sticker <input type="checkbox"/>	Gift Box <input type="checkbox"/>	Head Card <input type="checkbox"/>
	STANDARD				
	USE FOR	Strong Attraction, Easy To Use And Harmless To Human, Animals And Environment.			

	NAME	Yellow Jacket Attraction Bait	ITEM NO.:	HC4404	
	MATERIAL	Natural Food Grade Material			
	WEIGHT	8g, 15g, 25g, 30g, 40g, 60g for choose			
	PACKING	Bulk Pack <input type="checkbox"/>	white Box+sticker <input type="checkbox"/>	Gift Box <input type="checkbox"/>	Head Card <input type="checkbox"/>
	STANDARD				
	USE FOR	Strong Attraction, Good Palatability, Easy To Use And Harmless To Human, Animals And Environment.			

	NAME	Wasp Attraction Bait	ITEM NO.:	HC4405	
	MATERIAL	Natural Food Grade Material			
	WEIGHT	8g, 15g, 25g, 30g, 40g, 60g for choose			
	PACKING	Bulk Pack <input type="checkbox"/>	white Box+sticker <input type="checkbox"/>	Gift Box <input type="checkbox"/>	Head Card <input type="checkbox"/>
	STANDARD				
	USE FOR	Strong Attraction, Good Palatability, Easy To Use And Harmless To Human, Animals And Environment.			

	NAME	Roach/Cockroach Attraction Bait	ITEM NO.:	HC4406	
	MATERIAL	Natural Food Grade Material			
	WEIGHT	8g, 15g, 25g, 30g, 40g, 60g for choose			
	PACKING	Bulk Pack <input type="checkbox"/>	white Box+sticker <input type="checkbox"/>	Gift Box <input type="checkbox"/>	Head Card <input type="checkbox"/>
	STANDARD				
	USE FOR	Strong Attraction, Good Palatability, Easy To Use And Harmless To Human, Animals And Environment.			



Powerful Pheromones

Category	Name Of Pests	Lure Type	Packing Specification	Matching Bug Catcher
Storage Sanitation	Tobacco Armour	Rubber Head/blister	20 Grains/bag 1 Grain Of Bag	Tobacco Armour Catcher
	Tobacco Pimples	Rubber Head	20 Grains/bag	Tobacco Nightworm Trap
	India Pantry Moth	Rubber Head	20 Grains/bag	Pantry Moth Trap
	Clothes Moths	Rubber Head	20 Grains/bag	Clothes Moth Trap
	The Fly	Solid	1 Part /bag	Fly Catcher
	The Cockroach		1 Part /bag	Cockroach Bug Trap
	Orchard Class	Orange Fruit Fly	Pe Bottle / The Paper	20 / Bag 10 / Bag
Apple Mot		Rubber Head	20 Grains/bag	Triangle Trap/boat Type Trap
Pear Worm		Rubber Head	20 Grains/bag	Triangle Trap/boat Type Trap
Peach Fruit Worm		Rubber Head	20 Grains/bag	Triangle Trap/boat Type Trap
Peach Borer Moth		Rubber Head	20 Grains/bag	Triangle Trap/boat Type Trap
Tea Garden Class	Tea Leafhoppers	Rubber Head	50 Grains/ Bag	Fly Trap
	Spiny Whitefly	Rubber Head	50 Grains/ Bag	Triangle Trap/boat Type Trap
	Tea Caterpillar	Rubber Head	20 Grains/ Bag	Triangle Trap/boat Type Trap
	Black Poison Moth Of Tea	Rubber Head	20 Grains/ Bag	Triangle Trap/boat Type Trap
	Tea Geometrid	Rubber Head	20 Grains/ Bag	Triangle Trap/boat Type Trap
	Tea Leaf Roller	Rubber Head	20 Grains/ Bag	Triangle Trap/boat Type Trap

Classi	Name Of Pests	Lure core type	Packing	Matching bug catcher
Vegetable Tobacco Field	Residual Mosquito	Pvc Capillary/rubber Head	10strip/bag 20 Grains/bag	Moth Universal Trap (Red Hole)
	Beet Armyworm	Pvc Capillary/rubber Head	10strip/bag 20 Grains/bag	Moth Universal Bug Trap Blue Hole
	Diamondback Moth	Pvc Capillary/rubber Head	10strip/bag 20 Grains/bag	Triangle Trap/boat Type Trap
	Thrips	Pvc Capillary	10strip/bag	Special Trap Board
	Whitefly	Pvc Capillary	10strip/bag	Trap Board
	Striped Flea Beetle	Pvc Capillary	50strip/bag	Special Trap Board
Rice Grain	Melon Fly	Pe Bottle/the Paper	10piece/bag 20 Pieces/bag	Fly Trap
	Black Cutworm	Pvc Capillary/rubber Head	10strip/bag 20 Grains/bag	Triangle Trap/boat Type Trap
	Oriental Tobacco Budworm	Pvc Capillary/rubber Head	10strip/bag 20 Grains/bag	Triangle Trap/boat Type Trap
	Corn Earworm	Pvc Capillary/rubber Head	10strip/bag 20 Grains/bag	Triangle Trap/boat Type Trap
Garden Class	Soybean Worm	Pvc Capillary	10strip/bag	Boat Type Trap
	Tomato Leafminer	Rubber Head	20 Grains/bag	Triangle Trap/boat Type Trap
	Asiatic Corn Borer	Pvc Capillary/rubber Head	10strip/bag 20 Grains/bag	Triangle Trap/boat Type Trap
	Bean Pod Borer	Pvc Capillary	10strip/bag	Triangle Trap/boat Type Trap
	Leaf Flies	Rubber Head	20 Grains/bag	Trap Board
	Striped Rice Borer	Pvc Capillary/rubber Head	10strip/bag 20 Grains/bag	Inverted Cone Trap/boat Type Trap
	Rice Leaf Roller	Pvc Capillary/rubber Head	10strip/bag 20 Grains/bag	Inverted Cone Trap/boat Type Trap
	Yellow Rice Borer	Pvc Capillary/rubber Head	10strip/bag 20 Grains/bag	Inverted Cone Trap/boat Type Trap
	Sweet Potato Weevil	Rubber Head	20 Grains/bag	Barrel Trap
Red Brown Armour	Cotton Core	5strip/bag	Traps	
Long-horned Beetle	Bags	2strip/bag	Traps	



Fruit Fly Trap



Fruit Fly Trap

Insect Control

	NAME	Fruit Fly Monitor With Bait	ITEM NO.:	HC4501
	SIZE	44x21mm		
	MATERIAL	PP+PET	Attraction Bait <input type="checkbox"/>	
	OEM/ODM	Factory Brand Design <input type="checkbox"/>	No Brand Design <input type="checkbox"/>	Customer Own Design <input type="checkbox"/>
	EXTRA SERVICE	Design For Customer <input type="checkbox"/>	Suggestions <input type="checkbox"/>	Develop New Item <input type="checkbox"/>
	PACKING	Bulk Pack <input type="checkbox"/>	White Box+sticker <input type="checkbox"/>	Gift Box <input type="checkbox"/>
	STANDARD			
	USE FOR	Strong Attraction, Good Palatability, Easy To Use And Harmless To Human, Animals And Environment.		

	NAME	Fruit Fly Monitor With Bait	ITEM NO.:	HC4502
	SIZE	44x21mm		
	MATERIAL	PP+PET	Attraction Bait <input type="checkbox"/>	
	OEM/ODM	Factory Brand Design <input type="checkbox"/>	No Brand Design <input type="checkbox"/>	Customer Own Design <input type="checkbox"/>
	EXTRA SERVICE	Design For Customer <input type="checkbox"/>	Suggestions <input type="checkbox"/>	Develop New Item <input type="checkbox"/>
	PACKING	Bulk Pack <input type="checkbox"/>	White Box+sticker <input type="checkbox"/>	Gift Box <input type="checkbox"/>
	STANDARD			
	USE FOR	Strong Attraction, Good Palatability, Easy To Use And Harmless To Human, Animals And Environment.		

	NAME	Fruit Fly Monitor With Bait	ITEM NO.:	HC4503
	SIZE	44x21mm		
	MATERIAL	PP+PET	Attraction Bait <input type="checkbox"/>	
	OEM/ODM	Factory Brand Design <input type="checkbox"/>	No Brand Design <input type="checkbox"/>	Customer Own Design <input type="checkbox"/>
	EXTRA SERVICE	Design For Customer <input type="checkbox"/>	Suggestions <input type="checkbox"/>	Develop New Item <input type="checkbox"/>
	PACKING	Bulk Pack <input type="checkbox"/>	White Box+sticker <input type="checkbox"/>	Gift Box <input type="checkbox"/>
	STANDARD			
	USE FOR	Strong Attraction, Good Palatability, Easy To Use And Harmless To Human, Animals And Environment.		

	NAME	Fruit Fly Monitor With Bait	ITEM NO.:	HC4504
	SIZE	44x21mm		
	MATERIAL	PP+PET	Attraction Bait <input type="checkbox"/>	
	OEM/ODM	Factory Brand Design <input type="checkbox"/>	No Brand Design <input type="checkbox"/>	Customer Own Design <input type="checkbox"/>
	EXTRA SERVICE	Design For Customer <input type="checkbox"/>	Suggestions <input type="checkbox"/>	Develop New Item <input type="checkbox"/>
	PACKING	Bulk Pack <input type="checkbox"/>	White Box+sticker <input type="checkbox"/>	Gift Box <input type="checkbox"/>
	STANDARD			
	USE FOR	Strong Attraction, Good Palatability, Easy To Use And Harmless To Human, Animals And Environment.		

	NAME	Fruit Fly Trap	ITEM NO.:	HC4505
	SIZE	11x11x16cm		
	MATERIAL		Attraction Bait <input type="checkbox"/>	
	OEM/ODM	Factory Brand Design <input type="checkbox"/>	No Brand Design <input type="checkbox"/>	Customer Own Design <input type="checkbox"/>
	EXTRA SERVICE	Design For Customer <input type="checkbox"/>	Suggestions <input type="checkbox"/>	Develop New Item <input type="checkbox"/>
	PACKING	Bulk Pack <input type="checkbox"/>	white Box+Sticker <input type="checkbox"/>	Gift Box <input type="checkbox"/>
	STANDARD	Pcs/Ctn, Measure: 纸箱尺寸, G.W/N.W:		
	USE FOR			



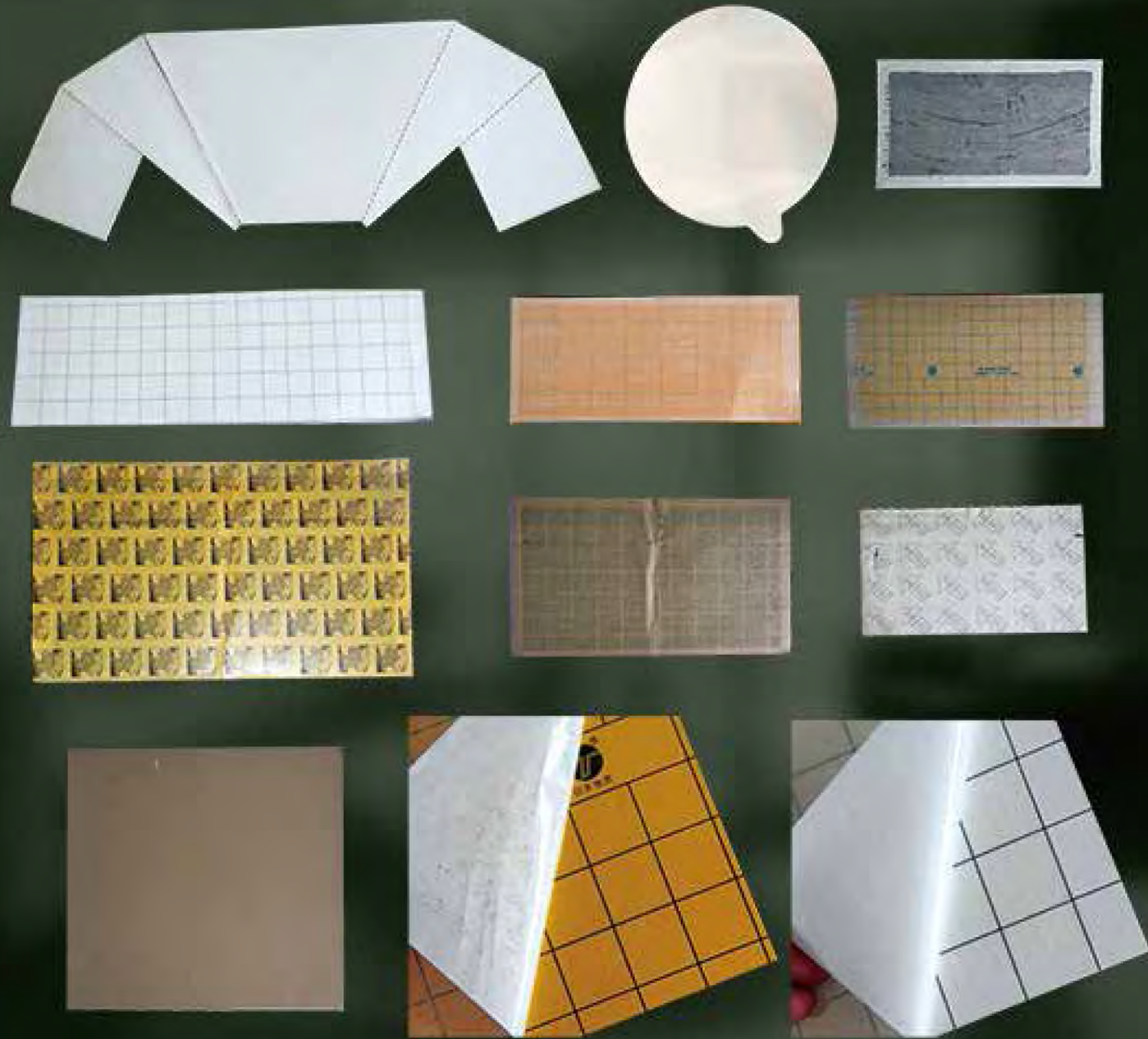

Insetc Light Sticker





Insect Control

	NAME	Fly Glue Trap	ITEM NO.:	HC4102	
	SIZE	12x12cm	MATERIAL	Paper+Glue	
	GLUE WEIGHT	80g/m ²			
	ATTRACTION BAIT	None			
	PACKING	Bulk Pack <input type="checkbox"/>	White Box+Sticker <input type="checkbox"/>	Gift Box <input type="checkbox"/>	Head Card <input type="checkbox"/>
	STANDARD	4Pcs/Set,96Sets/Ctn, Measure: 25.5x23.5x16cm , G.W/N.W: 3.5/3kgs			
	USE FOR				

	NAME	Fly Glue Trap	ITEM NO.:	HC4108S1	
	SIZE	1"x14ft	MATERIAL	Paper+Glue 28g	
	GLUE WEIGHT	80g/m ²			
	ATTRACTION BAIT	None			
	PACKING	Bulk Pack <input type="checkbox"/>	White Box+Sticker <input type="checkbox"/>	Gift Box <input type="checkbox"/>	Head Card <input type="checkbox"/>
	STANDARD				
	USE FOR				

	NAME	Fly Glue Trap	ITEM NO.:	HC4108	
	SIZE	25cmx10m 260g	MATERIAL	Paper+Glue	
	GLUE WEIGHT	80g/m ²			
	ATTRACTION BAIT	None			
	PACKING	Bulk Pack <input type="checkbox"/>	White Box+Sticker <input type="checkbox"/>	Gift Box <input type="checkbox"/>	Head Card <input type="checkbox"/>
	STANDARD	24Pcs/Ctn, Measure:36x 25x27.5cm , G.W/N.W: 9/8kgs			
	USE FOR				

	NAME	Fly Glue Trap	ITEM NO.:	HC4101	
	SIZE	2cmx70cm	MATERIAL	Paper+Glue 8.5g	
	GLUE WEIGHT	80g/m ² 8.5g/pcs			
	ATTRACTION BAIT	None			
	PACKING	Bulk Pack <input type="checkbox"/>	White Box+Sticker <input type="checkbox"/>	Gift Box <input type="checkbox"/>	Head Card <input type="checkbox"/>
	STANDARD	4Pcs/Card, 144Cards/Carton, Measure:38x 30x37cm, G.W/N.W:8/6kgs			
	USE FOR				

	NAME	Widow Sticker Fly Glue Trap	ITEM NO.:	HC4105	
	SIZE	4.5x80cm	MATERIAL	Paper+Glue	
	GLUE WEIGHT	80g/m ²			
	ATTRACTION BAIT	None			
	PACKING	Bulk Pack <input type="checkbox"/>	White Box+Sticker <input type="checkbox"/>	Gift Box <input type="checkbox"/>	Head Card <input type="checkbox"/>
	STANDARD	4Traps/Box			
	USE FOR				



	NAME	Cockroach/Roach Glue Trap	ITEM NO.:	HC4109	
	SIZE	10x15cm 231g/box	MATERIAL	Paper+Glue	
	GLUE WEIGHT	70g/m ²			
	ATTRACTION BAIT	None			
	PACKING	Bulk Pack <input type="checkbox"/>	white Box+Sticker <input type="checkbox"/>	Gift Box <input type="checkbox"/>	Head Card <input type="checkbox"/>
	STANDARD	12Pcs/Box,60Boxes/Ctn, Measure: 42x33x31.5cm, G.W/N.W:14.8/13.8kgs			
	USE FOR	Cockroaches For German Cockroaches, Australian Cockroaches, Black Breast Cockroaches,Japanese Cockroaches, Etc.			

	NAME	Cockroach/Roach Glue Trap	ITEM NO.:	HC4109S	
	SIZE	10x15cm 60g/box	MATERIAL	Paper+Glue	
	GLUE WEIGHT	70g/m ²			
	ATTRACTION BAIT	None			
	PACKING	Bulk Pack <input type="checkbox"/>	white Box+Sticker <input type="checkbox"/>	Gift Box <input type="checkbox"/>	Head Card <input type="checkbox"/>
	STANDARD	3Pcs/Bag,240Bags/Ctn, Measure: 42x33x31.5cm, G.W/N.W:15.4/14.4kgs			
	USE FOR	Cockroaches For German Cockroaches, Australian Cockroaches, Black Breast Cockroaches,Japanese Cockroaches, Etc.			

	NAME	Cockroach/Roach Glue Trap	ITEM NO.:	HC4112	
	SIZE	13.5x22cm 100g/box	MATERIAL	Paper+Glue	
	GLUE WEIGHT	70g/m ²			
	ATTRACTION BAIT	None			
	PACKING	Bulk Pack <input type="checkbox"/>	white Box+Sticker <input type="checkbox"/>	Gift Box <input type="checkbox"/>	Head Card <input type="checkbox"/>
	STANDARD	6Pcs/Box,100Boxes/Ctn, Measure:44x23x15cm, G.W/N.W:11/10kgs			
	USE FOR	Cockroaches For German Cockroaches, Australian Cockroaches, Blackbreast Cockroaches, Japanese Cockroaches, Etc.			

	NAME	Cockroach/Roach Glue Trap	ITEM NO.:	HC4110	
	SIZE	14x6.5x3.4cm	MATERIAL	Paper+Glue	
	GLUE WEIGHT	70g/m ²			
	ATTRACTION BAIT	None			
	PACKING	Bulk Pack <input type="checkbox"/>	white Box+Sticker <input type="checkbox"/>	Gift Box <input type="checkbox"/>	Head Card <input type="checkbox"/>
	STANDARD	2Pcs/Box,100Boxes/Ctn,Measure:59.5x42x36.5cm, G.W/N.W:8.5/7.5kgs			
	USE FOR	Cockroaches for German Cockroaches, Australian Cockroaches, Blackbreast Cockroaches, Japanese Cockroaches, etc.			

	NAME	Cockroach/Roach Trap	ITEM NO.:	HC4115	
	SIZE	12x12x4.5cm	MATERIAL	PP+ABS 116g	
	ATTRACTION BAIT	inside			
	PACKING	Bulk Pack <input type="checkbox"/>	white Box+Sticker <input type="checkbox"/>	Gift Box <input type="checkbox"/>	Head Card <input type="checkbox"/>
	STANDARD	1Pcs/Box,80Boxes/Ctn, Measure:53x53x28.5cm, G.W/N.W:15/14kgs			
	USE FOR	Cockroaches for German Cockroaches, Australian Cockroaches, Blackbreast Cockroaches, Japanese Cockroaches, etc.			

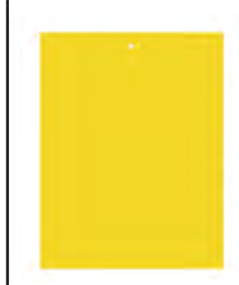
	NAME	Yellow Sticker Insect Trap	ITEM NO.:	HC4210
	SIZE	10x14cm with Spring Supporter		
	MATERIAL	PVC+Glue	Lifting Rope <input type="checkbox"/>	
	EXTRA SERVICE	Design For Customer <input type="checkbox"/>	OEM/ODM <input type="checkbox"/>	Develop New Item <input type="checkbox"/>
	PACKING	Bulk Pack <input type="checkbox"/>	White Box+Sticker <input type="checkbox"/>	Gift Box <input type="checkbox"/>
	STANDARD	10Pcs/Box, 120Boxes/Ctn, Measure: 45x37x25cm		
	USE FOR	Mass Trapping Bactrocera Cucurbitae (Melcon fly), Bactrocera dorsalis(Oriental Fruit Fly), Empoasca Vitis Gothe, Phyllotreta striolata, Trialeurodes Vaporariorum (Whitefly), etc.Used In Orchard,Greenhouse,Farm Field		

	NAME	Yellow Sticker Insect Trap	ITEM NO.:	HC4206
	SIZE	24x17cm		
	MATERIAL	PVC+Glue	Lifting Rope <input type="checkbox"/>	
	EXTRA SERVICE	Design For Customer <input type="checkbox"/>	OEM/ODM <input type="checkbox"/>	Develop New Item <input type="checkbox"/>
	PACKING	Bulk Pack <input type="checkbox"/>	White Box+Sticker <input type="checkbox"/>	Gift Box <input type="checkbox"/>
	STANDARD	10Pcs/Ctn, 48Boxes/Ctn, Measure: 37.5x32x29cm G.W/N.W: 7/6kgs		
	USE FOR	Mass Trapping Bactrocera Cucurbitae (Melcon fly), Bactrocera dorsalis(Oriental Fruit Fly), Empoasca Vitis Gothe, Phyllotreta striolata, Trialeurodes Vaporariorum (Whitefly), etc.Used In Orchard,Greenhouse,Farm Field		

	NAME	Yellow Sticker Insect Trap	ITEM NO.:	HC4207
	SIZE	20x10cm		
	MATERIAL	PVC+Glue	Lifting Rope <input type="checkbox"/>	
	EXTRA SERVICE	Design For Customer <input type="checkbox"/>	OEM/ODM <input type="checkbox"/>	Develop New Item <input type="checkbox"/>
	PACKING	Bulk Pack <input type="checkbox"/>	White Box+Sticker <input type="checkbox"/>	Gift Box <input type="checkbox"/>
	STANDARD	10Pcs/Ctn, 48Boxes/Ctn, Measure: 22x32x29cm G.W/N.W: 6/5kgs		
	USE FOR	Mass Trapping Bactrocera Cucurbitae (Melcon fly), Bactrocera dorsalis(Oriental Fruit Fly), Empoasca Vitis Gothe, Phyllotreta striolata, Trialeurodes Vaporariorum (Whitefly), etc.Used In Orchard,Greenhouse,Farm Field		

	NAME	Yellow Sticker Insect Trap	ITEM NO.:	HC4208
	SIZE	9.5x3.5cm		
	MATERIAL	PVC+Glue	Lifting Rope <input type="checkbox"/>	
	EXTRA SERVICE	Design For Customer <input type="checkbox"/>	OEM/ODM <input type="checkbox"/>	Develop New Item <input type="checkbox"/>
	PACKING	Bulk Pack <input type="checkbox"/>	White Box+Sticker <input type="checkbox"/>	Gift Box <input type="checkbox"/>
	STANDARD	30Pcs/Ctn, 120Boxes/Ctn, Measure: 50x34x21cm G.W/N.W: 12/11kgs		
	USE FOR	Mass Trapping Bactrocera Cucurbitae (Melcon fly), Bactrocera dorsalis(Oriental Fruit Fly), Empoasca Vitis Gothe, Phyllotreta striolata, Trialeurodes Vaporariorum (Whitefly), etc.Used In Orchard,Greenhouse,Farm Field		

	NAME	Yellow Sticker Insect Trap	ITEM NO.:	HC4209
	SIZE	24x10cm		
	MATERIAL	PVC+Glue	Lifting Rope <input type="checkbox"/>	
	EXTRA SERVICE	Design For Customer <input type="checkbox"/>	OEM/ODM <input type="checkbox"/>	Develop New Item <input type="checkbox"/>
	PACKING	Bulk Pack <input type="checkbox"/>	White Box+Sticker <input type="checkbox"/>	Gift Box <input type="checkbox"/>
	STANDARD	5Pcs/Ctn, 120Boxes/Ctn, Measure: 35x26x25cmcm G.W/N.W: 9/8kgs		
	USE FOR	Mass Trapping Bactrocera Cucurbitae (Melcon fly), Bactrocera dorsalis(Oriental Fruit Fly), Empoasca Vitis Gothe, Phyllotreta striolata, Trialeurodes Vaporariorum (Whitefly), etc.Used In Orchard,Greenhouse,Farm Field		





	NAME	Yellow Sticker Supporter		ITEM NO.:	HC4211
	SIZE	2.4mmx266mm			
	MATERIAL	Steel	Lifting Rope <input type="checkbox"/>		
	EXTRA SERVICE	Design For Customer <input type="checkbox"/>	OEM/ODM <input type="checkbox"/>	Develop New Item <input type="checkbox"/>	
	PACKING	Bulk Pack <input type="checkbox"/>	White Box+Sticker <input type="checkbox"/>	Gift Box <input type="checkbox"/>	
	STANDARD				
	USE FOR				

	NAME	Yellow Sticker Insect Trap		ITEM NO.:	HC4212
	SIZE	13X8CM			
	MATERIAL	PVC+Glue	Lifting Rope <input type="checkbox"/>		
	EXTRA SERVICE	Design For Customer <input type="checkbox"/>	OEM/ODM <input type="checkbox"/>	Develop New Item <input type="checkbox"/>	
	PACKING	Bulk Pack <input type="checkbox"/>	White Box+Sticker <input type="checkbox"/>	Gift Box <input type="checkbox"/>	
	STANDARD	30Pcs/Box, 120Boxes/CTN, Measure: 50x34x21cm, G.W/N.W:14/13kgs			
	USE FOR	Mass Trapping Bactrocera Cucurbitae (Melcon fly), Bactrocera dorsalis(Oriental Fruit Fly), Empoasca Vitis Gothe, Phyllotreta striolata, Trialeurodes Vaporariorum (Whitefly), etc.Used In Orchard,Greenhouse,Farm Field			

	NAME	Yellow Sticker Insect Trap		ITEM NO.:	HC4251
	SIZE	21x27x14cm			
	MATERIAL	PP+Glue Paper	Lifting Rope <input type="checkbox"/>		
	EXTRA SERVICE	Design For Customer <input type="checkbox"/>	OEM/ODM <input type="checkbox"/>	Develop New Item <input type="checkbox"/>	
	PACKING	Bulk Pack <input type="checkbox"/>	White Box+Sticker <input type="checkbox"/>	Gift Box <input type="checkbox"/>	
	STANDARD				
	USE FOR				

	NAME	Yellow Sticker Insect Trap		ITEM NO.:	HC4252
	SIZE	27x20x12cm			
	MATERIAL	PP+Glue Paper	Lifting Rope <input type="checkbox"/>		
	EXTRA SERVICE	Design For Customer <input type="checkbox"/>	OEM/ODM <input type="checkbox"/>	Develop New Item <input type="checkbox"/>	
	PACKING	Bulk Pack <input type="checkbox"/>	White Box+Sticker <input type="checkbox"/>	Gift Box <input type="checkbox"/>	
	STANDARD				
	USE FOR				

	NAME	Cigarette Beetle Monitor Trap		ITEM NO.:	HC4601
	SIZE	31x13cm (13x11x7cm)		MATERIAL	Paper+Glue
	GLUE WEIGHT	70g~80g/m ²			
	ATTRACTION BAIT	Pheromone			
	PACKING	Bulk Pack <input type="checkbox"/>	white Box+Sticker <input type="checkbox"/>	Gift Box <input type="checkbox"/>	Display Box <input type="checkbox"/>
	STANDARD				
	USE FOR	Target Pests:Roaches, Spiders And Other Crawling Household Pests, Disposable, Eco-Friendly,			

	NAME	Insect Monitor Trap		ITEM NO.:	HC4602
	SIZE	22x10x3cm		MATERIAL	Paper+Glue 70g/Set
	GLUE WEIGHT	70g~80g/m ²			
	ATTRACTION BAIT	None			
	PACKING	Bulk Pack <input type="checkbox"/>	white Box+Sticker <input type="checkbox"/>	Gift Box <input type="checkbox"/>	Display Box <input type="checkbox"/>
	STANDARD	3Pcs/Box,200Boxes/Ctn,Measure:26.5x24.5x22cm, G.W/N.W:15/14kgs			
	USE FOR	Target Pests:Roaches, Spiders And Other Crawling Household Pests, Disposable, Eco-Friendly,			

	NAME	Scorpion Monitor Trap		ITEM NO.:	HC4603
	SIZE	22x10x3cm		MATERIAL	Paper+Glue 70g/Set
	GLUE WEIGHT	70g~80g/m ²			
	ATTRACTION BAIT	None			
	PACKING	Bulk Pack <input type="checkbox"/>	white Box+Sticker <input type="checkbox"/>	Gift Box <input type="checkbox"/>	Display Box <input type="checkbox"/>
	STANDARD	3Pcs/Box,200Boxes/Ctn, Measure:26.5x24.5x22cm, G.W/N.W:15/14kgs			
	USE FOR	Target Pests:Roaches, Spiders And Other Crawling Household Pests, Disposable, Eco-Friendly,			

	NAME	Scorpion Monitor Trap		ITEM NO.:	HC4603S
	SIZE	22x10x3cm		MATERIAL	Paper+Glue 69g/Set
	GLUE WEIGHT	70g~80g/m ²			
	ATTRACTION BAIT	None			
	PACKING	Bulk Pack <input type="checkbox"/>	white Box+Sticker <input type="checkbox"/>	Gift Box <input type="checkbox"/>	Display Box <input type="checkbox"/>
	STANDARD	3Pcs/Bag, 200Boxes/Ctn,Measure:26.5x24.5x22cm, G.W/N.W:14.8/13.8kgs			
	USE FOR	Target Pests:Roaches, Spiders And Other Crawling Household Pests, Disposable, Eco-Friendly,			

	NAME	Flea/Bug Glue Trap		ITEM NO.:	HC4604
	SIZE	20x20cm		MATERIAL	Paper+Glue
	GLUE WEIGHT	70g~80g/m ²			
	ATTRACTION BAIT	Pheromone			
	PACKING	Bulk Pack <input type="checkbox"/>	white Box+Sticker <input type="checkbox"/>	Gift Box <input type="checkbox"/>	Display Box <input type="checkbox"/>
	STANDARD				
	USE FOR	Target Pests:Roaches, Spiders And Other Crawling Household Pests, Disposable, Eco-Friendly,			

	NAME	Flea/Bug Trap		ITEM NO.:	HC4605
	SIZE	15x15x3cm		MATERIAL	ABS
	ATTRACTION BAIT	None			
	PACKING	Bulk Pack <input type="checkbox"/>	white Box+Sticker <input type="checkbox"/>	Gift Box <input type="checkbox"/>	Display Box <input type="checkbox"/>
	STANDARD	4Pcs/Box,180Pcs/Ctn, Measure:54x54x52CM G.W/N.W:22/20KGS			
	USE FOR	Target Pests:Roaches, Spiders And Other Crawling Household Pests, Disposable, Eco-Friendly,			
	USE FOR				





	NAME	Flea/Bug Glue Trap Lamp	ITEM NO.:	HC4607	
	SIZE	18.5x10cm	MATERIAL	PP	
	GLUE WEIGHT	70g~80g/m ²			
	ATTRACTION BAIT	None			
	PACKING	Bulk Pack <input type="checkbox"/>	white Box+Sticker <input type="checkbox"/>	Gift Box <input type="checkbox"/>	Display Box <input type="checkbox"/>
	STANDARD	30Pcs/Ctn, Measure:61x41x39cm, G.W/N.W:12.3/11.3kgs			
	USE FOR	Catch Fleas,Bugs,Moths			

	NAME	Flea/Bug Glue Trap	ITEM NO.:	HC4608	
	SIZE	D:18cm 24g	MATERIAL	Paper+Glue	
	GLUE WEIGHT	70G~80g/m ²			
	ATTRACTION BAIT	Pheromone			
	PACKING	Bulk Pack <input type="checkbox"/>	white Box+Sticker <input type="checkbox"/>	Gift Box <input type="checkbox"/>	Display Box <input type="checkbox"/>
	STANDARD	200Pcs/Ctn			
	USE FOR	Catch Fleas,Bugs,Moths			

	NAME	Flea/Bug Glue Trap	ITEM NO.:	HC4609	
	SIZE	22x10x3cm	MATERIAL	Paper+Glue 70g/Set	
	GLUE WEIGHT	70g~80g/m ²			
	ATTRACTION BAIT	None			
	PACKING	Bulk Pack <input type="checkbox"/>	white Box+Sticker <input type="checkbox"/>	Gift Box <input type="checkbox"/>	Display Box <input type="checkbox"/>
	STANDARD	3Pcs/Box, 200Boxes/Ctn, Measure:28.5x26x28cm, G.W/N.W:15/14kgs			
	USE FOR	Catch Fleas,Bugs,Moths,Spiders,And Other Crawling Household Pests			

	NAME	Insect Monitor Trap	ITEM NO.:	HC4610	
	SIZE	22X10X3CM 15g	MATERIAL	Paper+Glue 70g/Set	
	GLUE WEIGHT	70g~80g/m ²			
	ATTRACTION BAIT	None			
	PACKING	Bulk Pack <input type="checkbox"/>	white Box+Sticker <input type="checkbox"/>	Gift Box <input type="checkbox"/>	Display Box <input type="checkbox"/>
	STANDARD	3Pcs/Box, 200Boxes/Ctn, Measure:28.5x26x28cm, G.W/N.W:15/14kgs			
	USE FOR	Catch Fleas,Bugs,Moths,Spiders,And Other Crawling Household Pests			

	NAME	Insect Monitor Trap	ITEM NO.:	HC4611	
	SIZE	22X10X3CM 15g	MATERIAL	PAPER+GLUE 70g/Set	
	GLUE WEIGHT	70G~80G/M ²			
	ATTRACTION BAIT	None			
	PACKING	Bulk Pack <input type="checkbox"/>	white Box+Sticker <input type="checkbox"/>	Gift Box <input type="checkbox"/>	Display Box <input type="checkbox"/>
	STANDARD	3Pcs/Box, 200Boxes/Ctn, Measure:28.5x26x28cm, G.W/N.W:15/14kgs			
	USE FOR	Catch Fleas,Bugs,Moths,Spiders,And Other Crawling Household Pests			

	NAME	Fruit Fly Trap	ITEM NO.:	HC4612
	SIZE	34x8.6cm		
	MATERIAL	Paper	Attraction Bait <input type="checkbox"/>	
	OEM/ODM	Factory Brand Design <input type="checkbox"/>	No Brand Design <input type="checkbox"/>	Customer Own Design <input type="checkbox"/>
	EXTRA SERVICE	Design For Customer <input type="checkbox"/>	Suggestions <input type="checkbox"/>	Develop New Item <input type="checkbox"/>
	PACKING	Bulk Pack <input type="checkbox"/>	white Box+Sticker <input type="checkbox"/>	Gift Box <input type="checkbox"/>
	STANDARD	6Pcs/Box,96Box/Ctn,Measure:38.2x31.4x29.4cm,G.W/N.W:11.08/10.08kgs		
	USE FOR	Catch Fruit Flies,Disposable, Eco-Friendly,		





Insect Control





Insect Control

	NAME	Pantry Moth Trap	ITEM NO.:	HC4301
	SIZE	30x11cm (11x11x8.5cm) 18.5g/pc	MATERIAL	Paper+Glue
	GLUE WEIGHT	70g-80g/m2	QTY PER UNIT	6
	ATTRACTION BAIT	Pheromone		
	PACKING	Bulk Pack <input type="checkbox"/> White Box+sticker <input type="checkbox"/>	Gift Box <input type="checkbox"/>	Display Box <input type="checkbox"/>
	EXTRA SERVICE	Design For Customer <input type="checkbox"/>	OEM/ODM <input type="checkbox"/>	Develop New Item <input type="checkbox"/>
	STANDARD	6Pcs/Box,120Boxes/Ctn, Measure:50x30.6x29cm G.W/N.W:15.9/14.9kgs		
	USE FOR	Catch Pantry Moths,Including Indian Meal Moths,Curtain Moth,Valley Moth,Other Food Moths.		

	NAME	Cloth Moth Trap	ITEM NO.:	HC4302
	SIZE	30x11cm (11x11x8.5cm) 18.5g/pc	MATERIAL	Paper+Glue
	GLUE WEIGHT	70g-80g/m2	QTY PER UNIT	6
	ATTRACTION BAIT	Pheromone		
	PACKING	Bulk Pack <input type="checkbox"/> White Box+sticker <input type="checkbox"/>	Gift Box <input type="checkbox"/>	Display Box <input type="checkbox"/>
	EXTRA SERVICE	Design For Customer <input type="checkbox"/>	OEM/ODM <input type="checkbox"/>	Develop New Item <input type="checkbox"/>
	STANDARD	6Pcs/Box,120Boxes/Ctn, Measure:50x30.6x29cm G.W/N.W:15.9/14.9kgs		
	USE FOR	Protect Wool And Other Natural Fibers From Damage Of Cloth Moth		

	NAME	Hook Type Cloth Moth Trap	ITEM NO.:	HC4303
	SIZE	34x11cm(15.5x11x9.5cm) 18.5g/pc	MATERIAL	Paper+Glue
	GLUE WEIGHT	70g-80g/m2	QTY PER UNIT	6
	ATTRACTION BAIT	Pheromone		
	PACKING	Bulk Pack <input type="checkbox"/> White Box+sticker <input type="checkbox"/>	Gift Box <input type="checkbox"/>	Display Box <input type="checkbox"/>
	EXTRA SERVICE	Design For Customer <input type="checkbox"/>	OEM/ODM <input type="checkbox"/>	Develop New Item <input type="checkbox"/>
	STANDARD	6Pcs/Box,120Boxes/Ctn, Measure:50x30.6x29cm G.W/N.W:15.9/14.9kgs		
	USE FOR	Protect Wool And Other Natural Fibers From Damage Of Cloth Moth		

	NAME	Pantry/Cloth Both Use Moth Trap	ITEM NO.:	HC4304
	SIZE	30x11cm (11x11x8.5cm) 18.5g/pc	MATERIAL	Paper+Glue
	GLUE WEIGHT	70g-80g/m2	QTY PER UNIT	6
	ATTRACTION BAIT	Pheromone		
	PACKING	Bulk Pack <input type="checkbox"/> White Box+sticker <input type="checkbox"/>	Gift Box <input type="checkbox"/>	Display Box <input type="checkbox"/>
	EXTRA SERVICE	Design For Customer <input type="checkbox"/>	OEM/ODM <input type="checkbox"/>	Develop New Item <input type="checkbox"/>
	STANDARD	6Pcs/Box,120Boxes/Ctn, Measure:50x30.6x29cm G.W/N.W:15.9/14.9kgs		
	USE FOR	Catch Pantry Moths And Clothes Mothes.		

	NAME	Hook Type Cloth Moth Trap	ITEM NO.:	HC4305
	SIZE	28.5x10x1.5cm 15g/pc	MATERIAL	Paper+Glue
	GLUE WEIGHT	70g-80g/m2	QTY PER UNIT	2
	ATTRACTION BAIT	Pheromone		
	PACKING	Bulk Pack <input type="checkbox"/> White Box+sticker <input type="checkbox"/>	Gift Box <input type="checkbox"/>	Display Box <input type="checkbox"/>
	EXTRA SERVICE	Design For Customer <input type="checkbox"/>	OEM/ODM <input type="checkbox"/>	Develop New Item <input type="checkbox"/>
	STANDARD	500Boxes/Ctn, Measure:44.6x39x45cm , G.W/N.W:16.8/15.8kgs		
	USE FOR	Protects Wool And Other Natural Fibers From Damage Of Cloth Moth		



Insect Control

	NAME	Pro Hook Type Cloth Moth Trap	ITEM NO.:	HC4306
	SIZE	28.5x10x1.5cm	MATERIAL	Paper+Glue
	GLUE WEIGHT	70g-80g/m2	QTY PER UNIT	2
	ATTRACTION BAIT	Pheromone		
	PACKING	Bulk Pack <input type="checkbox"/> White Box+sticker <input type="checkbox"/>	Gift Box <input type="checkbox"/>	Display Box <input type="checkbox"/>
	EXTRA SERVICE	Design For Customer <input type="checkbox"/>	OEM/ODM <input type="checkbox"/>	Develop New Item <input type="checkbox"/>
	STANDARD	2Pcs/Box, 125Boxes/Ctn, Measure: 54x33x32cm, G.W/N.W: 15.46/14.46kgs		
	USE FOR	Protects Wool And Other Natural Fibers From Damage Of Cloth Moth		

	NAME	Pro Hook Type Cloth Moth Trap	ITEM NO.:	HC4307
	SIZE	28.5x10x1.5cm	MATERIAL	PAPER+GLUE
	GLUE WEIGHT	70g-80g/m2	QTY PER UNIT	4
	ATTRACTION BAIT	Pheromone		
	PACKING	Bulk Pack <input type="checkbox"/> White Box+sticker <input type="checkbox"/>	Gift Box <input type="checkbox"/>	Display Box <input type="checkbox"/>
	EXTRA SERVICE	Design For Customer <input type="checkbox"/>	OEM/ODM <input type="checkbox"/>	Develop New Item <input type="checkbox"/>
	STANDARD			
	USE FOR	Protect Wool And Other Natural Fibers From Damage Of Cloth Moth		

	NAME	Pro Hook Type Cloth Moth Trap	ITEM NO.:	HC4308
	SIZE	34x11cm(15.5x11x9.5cm)	MATERIAL	Paper+Glue
	GLUE WEIGHT	70g-80g/m2	QTY PER UNIT	6
	ATTRACTION BAIT	Pheromone		
	PACKING	Bulk Pack <input type="checkbox"/> White Box+sticker <input type="checkbox"/>	Gift Box <input type="checkbox"/>	Display Box <input type="checkbox"/>
	EXTRA SERVICE	Design For Customer <input type="checkbox"/>	OEM/ODM <input type="checkbox"/>	Develop New Item <input type="checkbox"/>
	STANDARD	6Pcs/Box, 120Boxes/Ctn, Measure: 50x30.6x29cm G.W/N.W: 15.9/14.9kgs		
	USE FOR	Protect Wool And Other Natural Fibers From Damage Of Cloth Moth		

	NAME	Moth Repellent Camphorwood	ITEM NO.:	HC4309
	SIZE	24x4.7x1cm	MATERIAL	55g
	QTY PER UNIT			
	PACKING	Bulk Pack <input type="checkbox"/> White Box+sticker <input type="checkbox"/>	Gift Box <input type="checkbox"/>	Display Box <input type="checkbox"/>
	EXTRA SERVICE	Design For Customer <input type="checkbox"/>	OEM/ODM <input type="checkbox"/>	Develop New Item <input type="checkbox"/>
	STANDARD	16Sets/Ctn, Measure: 43x23x26cm G.W/N.W: 7.25/6.25kgs		
	USE FOR	Catch Pantry Moths And Clothes Moths.		

	NAME	Flies/Insect Trap Lamp	ITEM NO.:	HC5116
	SIZE	23x10x31cm	MATERIAL	Iron+Powder Coating
	POWER	110V/240V 20W(1x20W)	COLOR	White
	PLUG TYPE		COVE AREA	100M ²
	EXTRA SERVICE	Design For Customer <input type="checkbox"/>	OEM/ODM <input type="checkbox"/>	Develop New Item <input type="checkbox"/>
	STANDARD	1Pc/Box, 4Boxes/Ctn		
	USE FOR	Suitable for many places, for kinds of pests, safe and effective		

Mosquito Pest Control...



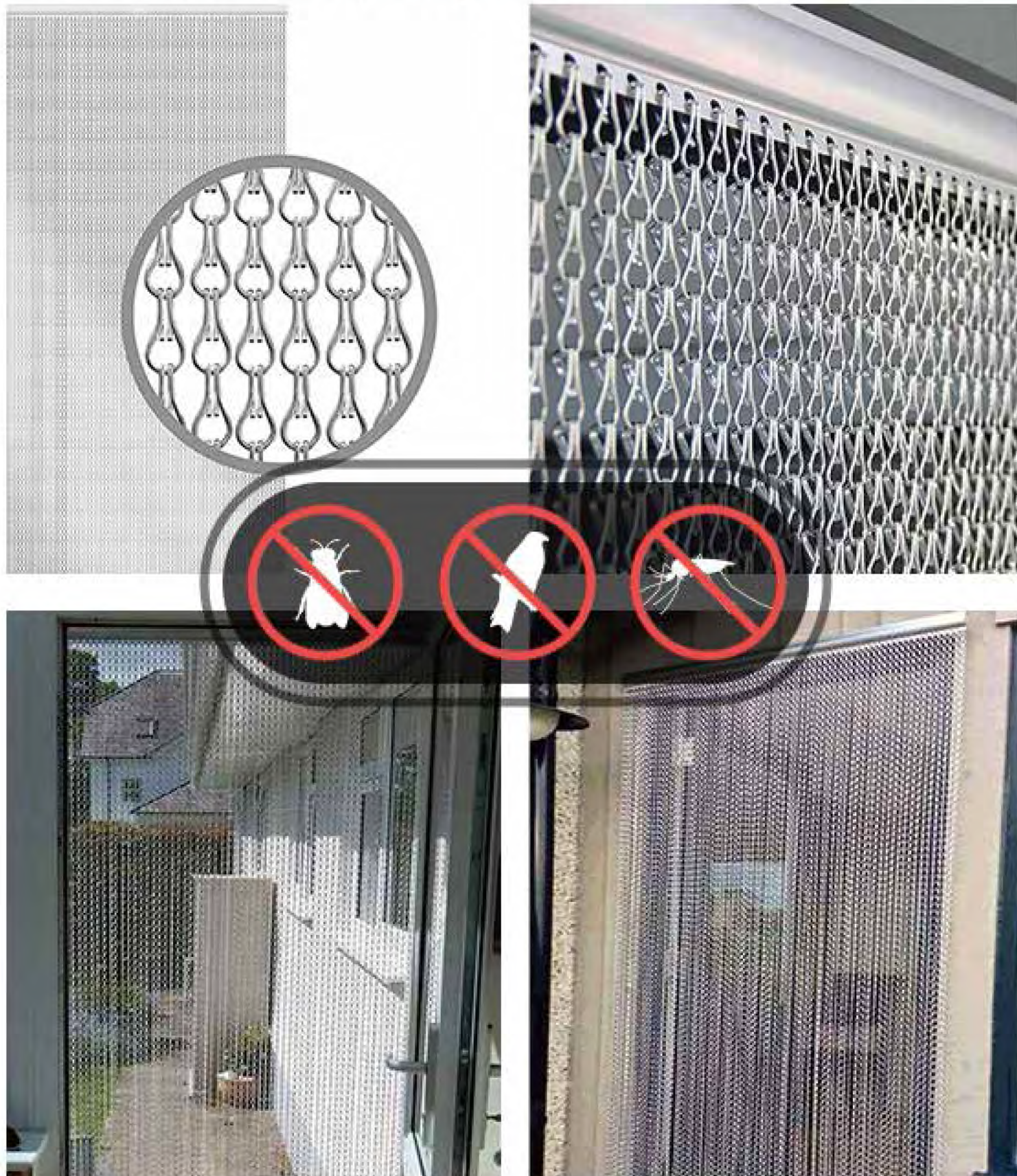

Anti Birds/Bat/Flies/Mosquito Aluminium Curtain Screen





Mosquito Control

	NAME	Solar Mosquito Catch Lamp Trap	ITEM NO.:	HC6121
	SIZE	Φ320x780mm	MATERIAL	Stainless Steel+Polysilicon solar panel
	POWER BY	Solar <input type="checkbox"/> Cable <input type="checkbox"/> Lithium Battery <input type="checkbox"/>	POWER	12V(DC)~4-5KV 5.5W
	LAMP TYPE		COVER AREA	80-100M ²
	PLUG TYPE			
	EXTRA SERVICE	Design For Customer <input type="checkbox"/>	OEM/ODM <input type="checkbox"/>	Develop New <input type="checkbox"/>
	STANDARD PACK	1Pc/Ctn		
	USE FOR	Easy way to kill mosquitos and insect outdoors		

	NAME	Solar Mosquito Catch Lamp Trap	ITEM NO.:	HC6122
	SIZE	Φ320x800mm	MATERIAL	Stainless Steel+Polysilicon solar panel
	POWER BY	Solar <input type="checkbox"/> Cable <input type="checkbox"/> Lithium Battery <input type="checkbox"/>	POWER	12v(DC)~4-5KV 5.5W
	LAMP TYPE		COVER AREA	80-100M ²
	PLUG TYPE			
	EXTRA SERVICE	Design For Customer <input type="checkbox"/>	OEM/ODM <input type="checkbox"/>	Develop New <input type="checkbox"/>
	STANDARD PACK	1Pc/Ctn		
	USE FOR	Easy way to kill mosquitos and insect outdoors		

	NAME	Solar Mosquito Catch Lamp Trap	ITEM NO.:	HC6130
	SIZE	570x540x1410mm	MATERIAL	Stainless Steel+Polysilicon solar panel
	POWER BY	Solar <input type="checkbox"/> Cable <input type="checkbox"/> Lithium Battery <input type="checkbox"/>	POWER	12v(DC)~3KV 10W
	LAMP TYPE		COVER AREA	1000-2000M ²
	PLUG TYPE			
	EXTRA SERVICE	Design For Customer <input type="checkbox"/>	OEM/ODM <input type="checkbox"/>	Develop New <input type="checkbox"/>
	STANDARD PACK	1Pc/Ctn		
	USE FOR	Easy way to kill mosquitos and insect outdoors		

	NAME	Solar Mosquito Catch Lamp Trap	ITEM NO.:	HC6124
	SIZE	570x540x2400mm	MATERIAL	Stainless Steel+Polysilicon solar panel
	POWER BY	Solar <input type="checkbox"/> Cable <input type="checkbox"/> Lithium Battery <input type="checkbox"/>	POWER	12v(DC)~3KV 15W
	LAMP TYPE		COVER AREA	2000-1000M ²
	PLUG TYPE			
	EXTRA SERVICE	Design For Customer <input type="checkbox"/>	OEM/ODM <input type="checkbox"/>	Develop New <input type="checkbox"/>
	STANDARD PACK	1Pc/Ctn		
	USE FOR	Easy way to kill mosquitos and insect outdoors		

	NAME	Solar Mosquito Catch Lamp Trap	ITEM NO.:	HC617S
	SIZE	300x300x780mm	MATERIAL	Stainless Steel+Polysilicon solar panel
	POWER BY	Solar <input type="checkbox"/> Cable <input type="checkbox"/> Lithium Battery <input type="checkbox"/>	POWER	110-256v 11w
	LAMP TYPE		COVER AREA	150M ²
	PLUG TYPE			
	EXTRA SERVICE	Design For Customer <input type="checkbox"/>	OEM/ODM <input type="checkbox"/>	DEVELOP NEW <input type="checkbox"/>
	STANDARD PACK	1Pc/Ctn		
	USE FOR	Easy way to kill mosquitos and insect outdoors		

NAME	Aluminium Curtain Screen			ITEM NO.:	HC5528A
SIZE	90X210CM (1.6mm)	MATERIAL	Aluminium	INSTALL PARTS	Nails+Hold Parts
EXTRA SERVICE	Design For Customer <input type="checkbox"/>		OEM/ODM <input type="checkbox"/>	Develop New <input type="checkbox"/>	
PACKING	Bulk Pack <input type="checkbox"/>	White Box+Sticker <input type="checkbox"/>		Gift Box <input type="checkbox"/>	
STANDARD	1 Pcs/Ctn				



Mosquito Control



NAME	Mosquito Catch Lamp Trap	ITEM NO.:	HC6116
SIZE	25x39cm	MATERIAL	ABS 1500g
POWER BY	Solar <input type="checkbox"/> Cable <input type="checkbox"/> Lithium Battery <input type="checkbox"/>	POWER	110V 8.5W
LAMP TYPE		COVER AREA	50-80M ²
PLUG TYPE			
EXTRA SERVICE	Design For Customer <input type="checkbox"/>	OEM/ODM <input type="checkbox"/>	Develop New <input type="checkbox"/>
STANDARD PACK	1Pc/Ctn		
USE FOR	No Chemical, Non-Toxic, Eco-Friendly, safe for the pregnant and infants Suitable for living room etc		



NAME	Mosquito Catch Lamp Trap	ITEM NO.:	HC6117
SIZE	32x30cm	MATERIAL	ABS 4200g
POWER BY	Solar <input type="checkbox"/> Cable <input type="checkbox"/> Lithium Battery <input type="checkbox"/>	POWER	110-120V/220V-240V 26W
LAMP TYPE		COVER AREA	100-120M ²
PLUG TYPE			
EXTRA SERVICE	Design For Customer <input type="checkbox"/>	OEM/ODM <input type="checkbox"/>	Develop New <input type="checkbox"/>
STANDARD PACK	1Pc/Ctn		
USE FOR	No Chemical, Non-Toxic, Eco-Friendly, safe for the pregnant and infants Suitable for living room etc		



NAME	Mosquito Catch Lamp Trap	ITEM NO.:	HC6117S
SIZE	32x32x119cm	MATERIAL	ABS
POWER BY	Solar <input type="checkbox"/> Cable <input type="checkbox"/> Lithium Battery <input type="checkbox"/>	POWER	110-120V/220V-240V 26W
LAMP TYPE		COVER AREA	100-120M ²
PLUG TYPE			
EXTRA SERVICE	Design For Customer <input type="checkbox"/>	OEM/ODM <input type="checkbox"/>	Develop New <input type="checkbox"/>
STANDARD PACK	1Pc/Ctn		
USE FOR	Easy way to kill mosquitos and insect outdoors		



NAME	Solar Mosquito Catch Lamp Trap	ITEM NO.:	HC6120
SIZE	Φ230	MATERIAL	Stainless Steel -PMMAV
POWER BY	Solar <input type="checkbox"/> Cable <input type="checkbox"/> Lithium Battery <input type="checkbox"/>	POWER	3.6V(DC)-1.2KV 1W
LAMP TYPE		COVER AREA	50-60M ²
PLUG TYPE			
EXTRA SERVICE	Design For Customer <input type="checkbox"/>	OEM/ODM <input type="checkbox"/>	Develop New <input type="checkbox"/>
STANDARD PACK	1Pc/Ctn		
USE FOR	Easy way to kill mosquitos and insect outdoors		



NAME	Solar Mosquito Catch Lamp Trap	ITEM NO.:	HC6119
SIZE	Φ230x590mm	MATERIAL	Stainless Steel+Polysilicon solar panel
POWER BY	Solar <input type="checkbox"/> Cable <input type="checkbox"/> Lithium Battery <input type="checkbox"/>	POWER	3.6V(DC)-1.2KV 0.6W
LAMP TYPE		COVER AREA	60-80M ²
PLUG TYPE			
EXTRA SERVICE	Design For Customer <input type="checkbox"/>	OEM/ODM <input type="checkbox"/>	Develop New <input type="checkbox"/>
STANDARD PACK	1Pc/Ctn		
USE FOR	Easy way to kill mosquitos and insect outdoors		



NAME	Kawaii Mosquito Bracelet For Child	ITEM NO.:	HC160004
COLOR	Red,White,Orange,Blue,Yellow,Pink,Purple	SIZE	22.5X2cm 30g
MATERIAL	Silica Gel		
INSTALL PARTS	Steel Sheet+Nails		
EXTRA SERVICE	Design For Customer <input type="checkbox"/>	OEM/ODM <input type="checkbox"/>	Develop New Item <input type="checkbox"/>
PACKING	Bulk Pack <input type="checkbox"/>	White Box+Sticker <input type="checkbox"/>	Gift Box <input type="checkbox"/>
STANDARD	24Cards/Box,6Boxes/Ctn,Measure:48x42x26cm,G.W/N.W:5.5/4.5kgs		
USE FOR	Simple to wear it on wrist, ankle ect, safe to adult as well as baby		



NAME	Sporting Type Mosquito Bracelet	ITEM NO.:	HC160005
HOME USE SIZE	24x3.3cm 24g		
MATERIAL	Cloth + PU		
INSTALL PARTS			
EXTRA SERVICE	Design For Customer <input type="checkbox"/>	OEM/ODM <input type="checkbox"/>	Develop New Item <input type="checkbox"/>
PACKING	Bulk Pack <input type="checkbox"/>	White Box+Sticker <input type="checkbox"/>	Gift Box <input type="checkbox"/>
STANDARD	24Pcs/Box,6Boxes/Ctn,Measure:36x36x22cm,G.W/N.W:4.5/3.5kgs		
USE FOR	Simple to wear it on wrist, ankle ect, safe to adult as well as baby		



NAME	Easy Hang Mosquito Bracelet	ITEM NO.:	HC160008-HW
HOME USE SIZE	5x6cm 7g		
MATERIAL	PU		
INSTALL PARTS			
EXTRA SERVICE	Design For Customer <input type="checkbox"/>	OEM/ODM <input type="checkbox"/>	Develop New Item <input type="checkbox"/>
PACKING	Bulk Pack <input type="checkbox"/>	White Box+Sticker <input type="checkbox"/>	Gift Box <input type="checkbox"/>
STANDARD	1Pc/Bag,500Bags/Ctn,Measure:47x42x25.5cm,G.W/N.W:9.5/8.5kgs		
USE FOR	Simple to wear it on wrist, ankle ect, safe to adult as well as baby		



NAME	PU Mosquito Bracelet	ITEM NO.:	HC160008-J
HOME USE SIZE	23.5x1.8cm 7.9g		
MATERIAL	PU		
INSTALL PARTS			
EXTRA SERVICE	Design For Customer <input type="checkbox"/>	OEM/ODM <input type="checkbox"/>	Develop New Item <input type="checkbox"/>
PACKING	Bulk Pack <input type="checkbox"/>	White Box+Sticker <input type="checkbox"/>	Gift Box <input type="checkbox"/>
STANDARD	1Pcs/Bag,1000Bags/Ctn,Measure:47x42x25.5cm,9.5/8.5kgs		
USE FOR	Simple to wear it on wrist, ankle ect, safe to adult as well as baby		





NAME	Spring Mosquito Bracelet	ITEM NO.:	HC160008-PE
HOME USE SIZE	5x6cm		
MATERIAL	PE		
INSTALL PARTS			
EXTRA SERVICE	Design For Customer <input type="checkbox"/>	OEM/ODM <input type="checkbox"/>	Develop New Item <input type="checkbox"/>
PACKING	Bulk Pack <input type="checkbox"/>	White Box+Sticker <input type="checkbox"/>	Gift Box <input type="checkbox"/>
STANDARD	1Pc/Bag,500Bags/Ctn,Measure:45x45x25.5cm,G.W/N.W:4.5/3.5kgs		
USE FOR	Simple to wear it on wrist, ankle ect, safe to adult as well as baby		





Mosquito Control

	NAME	Fly & Mosquito Catch Lamp Trap	ITEM NO.	HC52000
	SIZE	26x9x5cm	MATERIAL	ABS
	POWER BY	SOLAR <input type="checkbox"/> CABLE <input type="checkbox"/> LITHIUM BATTERY <input type="checkbox"/>	POWER	20W
	LAMP TYPE		COVER AREA	
	PLUG TYPE			
	EXTRA SERVICE	DESIGN FOR CUSTOMER <input type="checkbox"/>	OEM/ODM <input type="checkbox"/>	DEVELOP NEW <input type="checkbox"/>
	STANDARD PACK	1pc/Box		
	USE FOR	Lighting lamp and as killer lamp		

	NAME	Fly & Mosquito Catch Lamp Trap	ITEM NO.	HC52001
	SIZE		MATERIAL	ABS
	POWER BY	SOLAR <input type="checkbox"/> CABLE <input type="checkbox"/> LITHIUM BATTERY <input type="checkbox"/>	POWER	
	LAMP TYPE		COVER AREA	
	PLUG TYPE			
	EXTRA SERVICE	DESIGN FOR CUSTOMER <input type="checkbox"/>	OEM/ODM <input type="checkbox"/>	DEVELOP NEW <input type="checkbox"/>
	STANDARD PACK	1pc/Box		
	USE FOR	Kill Fly & Mosquito		

	NAME	Fly & Mosquito Catch Lamp Trap	ITEM NO.	HC52002
	SIZE		MATERIAL	ABS
	POWER BY	SOLAR <input type="checkbox"/> CABLE <input type="checkbox"/> LITHIUM BATTERY <input type="checkbox"/>	POWER	
	LAMP TYPE		COVER AREA	
	PLUG TYPE			
	EXTRA SERVICE	DESIGN FOR CUSTOMER <input type="checkbox"/>	OEM/ODM <input type="checkbox"/>	DEVELOP NEW <input type="checkbox"/>
	STANDARD PACK	1pc/Box		
	USE FOR	Kill Fly & Mosquito		

	NAME	Fly & Mosquito Catch Lamp Trap	ITEM NO.	HC52003
	SIZE		MATERIAL	ABS
	POWER BY	SOLAR <input type="checkbox"/> CABLE <input type="checkbox"/> LITHIUM BATTERY <input type="checkbox"/>	POWER	
	LAMP TYPE		COVER AREA	
	PLUG TYPE			
	EXTRA SERVICE	DESIGN FOR CUSTOMER <input type="checkbox"/>	OEM/ODM <input type="checkbox"/>	DEVELOP NEW <input type="checkbox"/>
	STANDARD PACK	1pc/Box		
	USE FOR	Kill Fly & Mosquito		

	NAME	Bait Of Mosquito Catch Lamp	ITEM NO.	HC52004
	SIZE		MATERIAL	
	POWER BY	SOLAR <input type="checkbox"/> CABLE <input type="checkbox"/> LITHIUM BATTERY <input type="checkbox"/>	POWER	
	LAMP TYPE		COVER AREA	
	PLUG TYPE			
	EXTRA SERVICE	DESIGN FOR CUSTOMER <input type="checkbox"/>	OEM/ODM <input type="checkbox"/>	DEVELOP NEW <input type="checkbox"/>
	STANDARD PACK			
	USE FOR	Allure Mosquito		

Insect Control

	NAME	Wasp/Mosquito Repellent Hat	ITEM NO.:	HC5529C
	HOME USE SIZE	37x44cm 85.5g		
	MATERIAL			
	INSTALL PARTS			
	EXTRA SERVICE	Design For Customer <input type="checkbox"/>	OEM/ODM <input type="checkbox"/>	Develop New Item <input type="checkbox"/>
	PACKING	Bulk Pack <input type="checkbox"/>	White Box+Sticker <input type="checkbox"/>	Gift Box <input type="checkbox"/>
	STANDARD			
	USE FOR	Anti-Mosquito Hat or Sun Hat!		

	NAME	Wasp/Mosquito Repellent Hat	ITEM NO.:	HC5529M
	HOME USE SIZE	36.7x48cm 88.5g		
	MATERIAL			
	INSTALL PARTS			
	EXTRA SERVICE	Design For Customer <input type="checkbox"/>	OEM/ODM <input type="checkbox"/>	Develop New Item <input type="checkbox"/>
	PACKING	Bulk Pack <input type="checkbox"/>	White Box+Sticker <input type="checkbox"/>	Gift Box <input type="checkbox"/>
	STANDARD			
	USE FOR	Anti-Mosquito Hat or Sun Hat!		

	NAME	Wasp/Mosquito Repellent Hat	ITEM NO.:	HC5529S
	HOME USE SIZE	36.5x44.5 88.5g		
	MATERIAL			
	INSTALL PARTS			
	EXTRA SERVICE	Design For Customer <input type="checkbox"/>	OEM/ODM <input type="checkbox"/>	Develop New Item <input type="checkbox"/>
	PACKING	Bulk Pack <input type="checkbox"/>	White Box+Sticker <input type="checkbox"/>	Gift Box <input type="checkbox"/>
	STANDARD			
	USE FOR	Anti-Mosquito Hat or Sun Hat!		



Temporary Animal Storage Cages

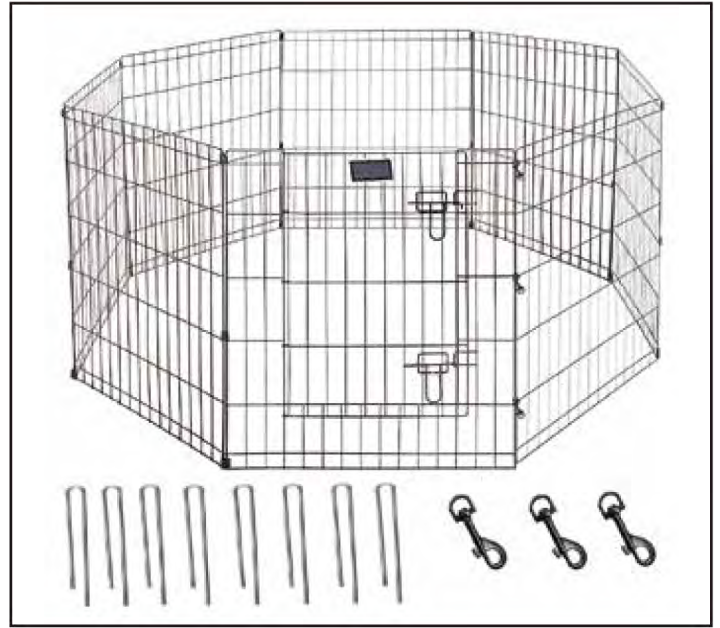

Hot selling American (American standard) double door dog cage, the raw material is made of high quality carbon steel wire, the surface is sprayed with plastic, beautiful and rustproof, single independent folding packaging, a variety of colors for you to choose

Hot-selling fence shade, the raw material is made of high quality low carbon steel wire, the surface is sprayed with plastic, beautiful and rust-proof, a variety of colors and sizes are available for your choice

TYPE	SIZE	WIRE DIAMETER	MOQ	DELIVERY	TYPE	SIZE
DSA24	61x43x51cm	2.4mm 3.0mm	1000pcs	45days	PP2424	60.96x60.96cm
DSA30	76.5x53.34x61cm	2.4mm 3.0mm	1000pcs	45days	PP2430	60.96x76.20cm
DSA36	91.4x58.4x66cm	3.0mm 3.5mm	500pcs	45days	PP2436	60.96x91.44cm
DSA42	106.7x63.5x73.7cm	3.0mm 3.5mm	500pcs	45days	PP2442	60.96x106.68cm
DSA48	122x68.6x78.7cm	3.5mm 4.0mm	500pcs	45days	PP2448	60.96x121.92cm

Hot Selling Pet Cage, Cat Cage ,bird Cage



TYPE	CT29	CT52	PC600A	PC600H
SIZE	91.44x58.42x73.66cm	91.44x58.42x132cm	50.8x50.8x147cm	50.8x50.8x147cm

