







-  Zona LAF
-  Clase B (>40-50) Pa
-  Clase B (35 ; 40) Pa
-  Clase C (>30-35) Pa
-  Clase C (25 ; 30) Pa
-  Clase D (10 ; 15) Pa

MASTER

COPIA DI LAVORO

Jel 01/03/14

Item	Description	Quantity	Unit	Value	Remarks
1
2
3
4
5
6
7
8
9
10
11
12
13
14
15
16
17
18
19
20
21
22
23
24
25
26
27
28
29
30
31
32
33
34
35
36
37
38
39
40
41
42
43
44
45
46
47
48
49
50
51
52
53
54
55
56
57
58
59
60
61
62
63
64
65
66
67
68
69
70
71
72
73
74
75
76
77
78
79
80
81
82
83
84
85
86
87
88
89
90
91
92
93
94
95
96
97
98
99
100

ROXANA MONTEMILONE
 DIRECTORA TÉCNICA
 SANDEF PASTEUR S.A.

CHRISTIAN DOMINGUEZ
 APODERADO
 SANDEF PASTEUR S.A.

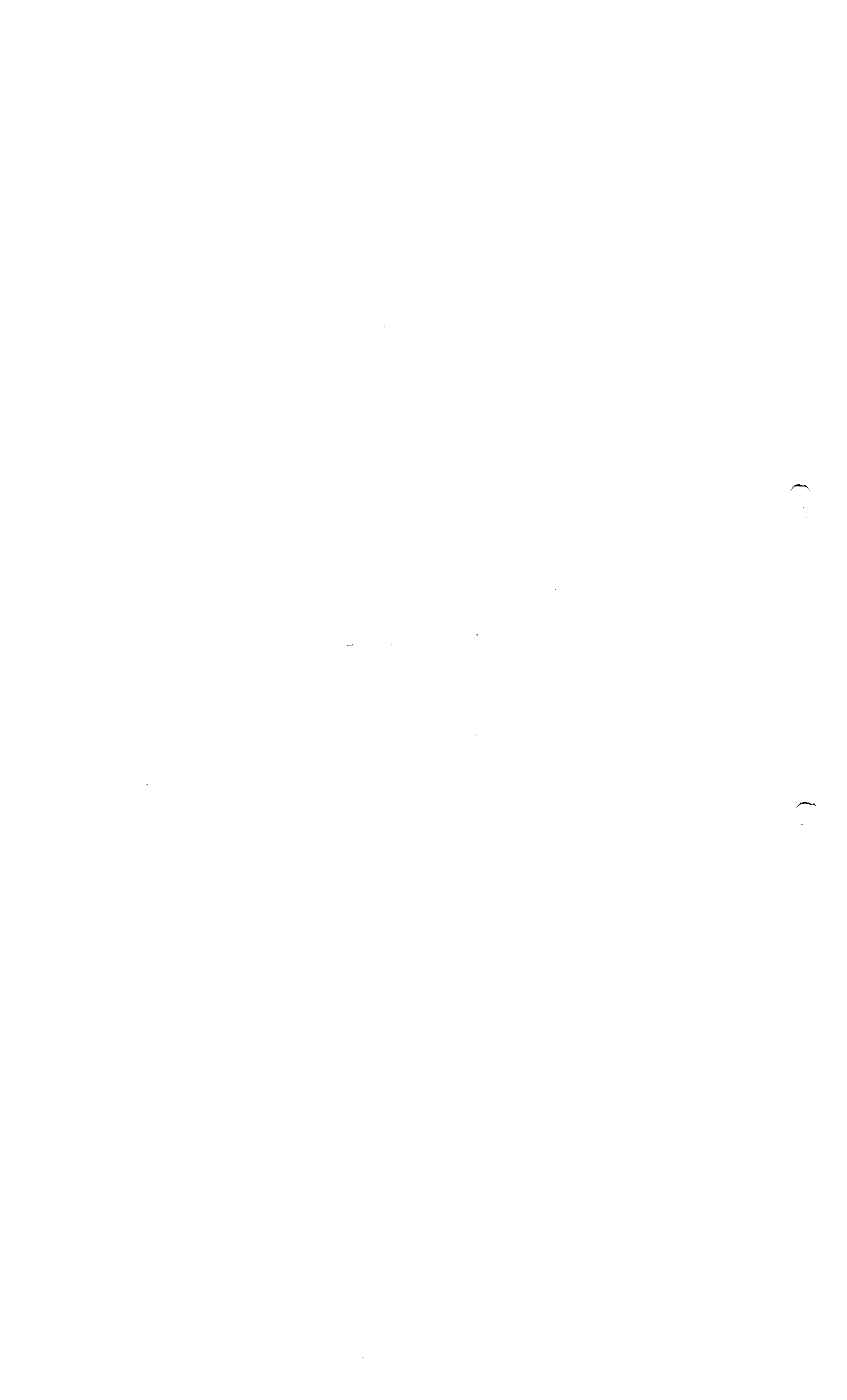

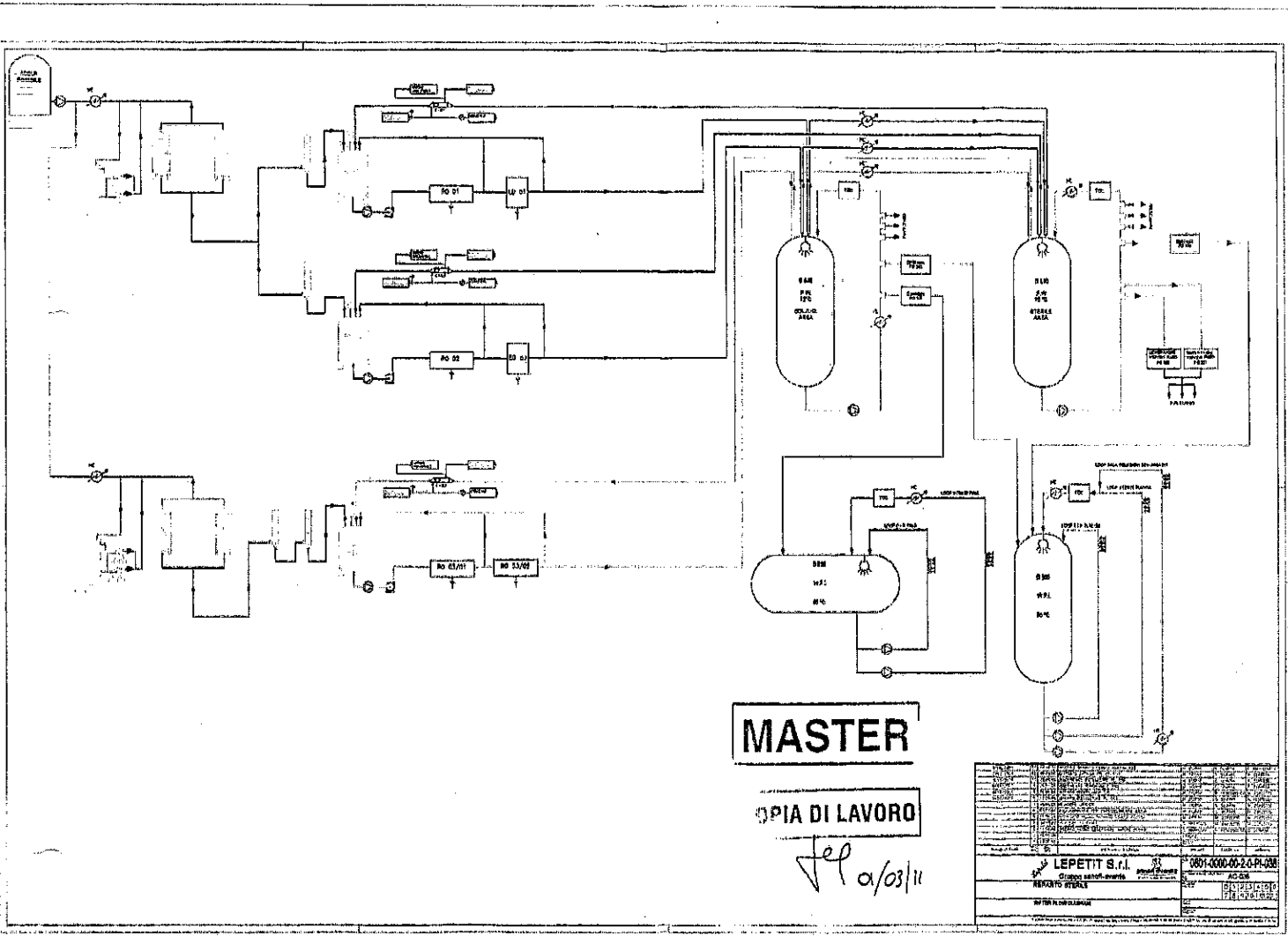

MASTER

COPIA DI LAVORO

del 01/03/11

LEPETIT S.A. Calle 10 de Agosto, 1000 Montevideo, Uruguay		001-400-00-20-0000
REPARTICIÓN TÉCNICA		AS-04
REPARTICIÓN TÉCNICA		PROYECTO
REPARTICIÓN TÉCNICA		PROYECTO

Roxana
 ROXANA MONTEMLONE
 DIRECTORA TÉCNICA
 SANCOR PASTEUR S.A.

Christian
 CHRISTIAN DOMINGUEZ
 APODERADO
 SANCOR PASTEUR S.A.

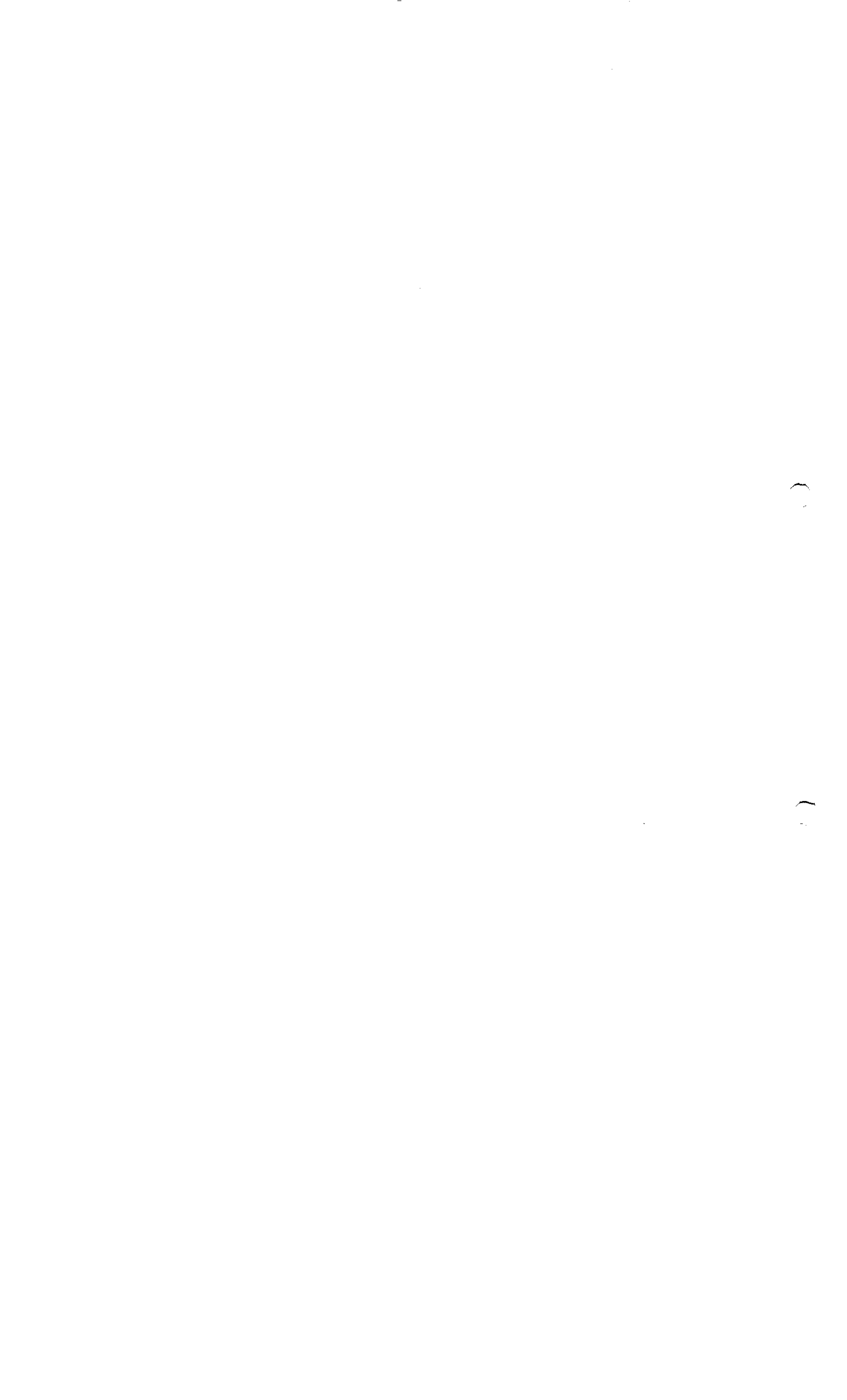



sanofi aventis

Because health matters

Sanofi aventis group
Gruppo Lepetit S.r.l.
Planta de Agnani, Italia

ANEXO 2

DIAGRAMAS DE FLUJO DE PRODUCCIÓN

Fecha: Febrero de 2011

Número total de páginas 7

ROXANA MONTEMILONE
DIRECTORA TÉCNICA
SANOFI PASTEUR S.A.

CHRISTIAN DOMINGUEZ
APODERADO
SANOFI PASTEUR S.A.



Tabla 1 – Diagrama de flujo de producción de cápsulas orales



Tabla 2 – Diagrama de flujo de producción de tabletas orales

Diagramas de flujo

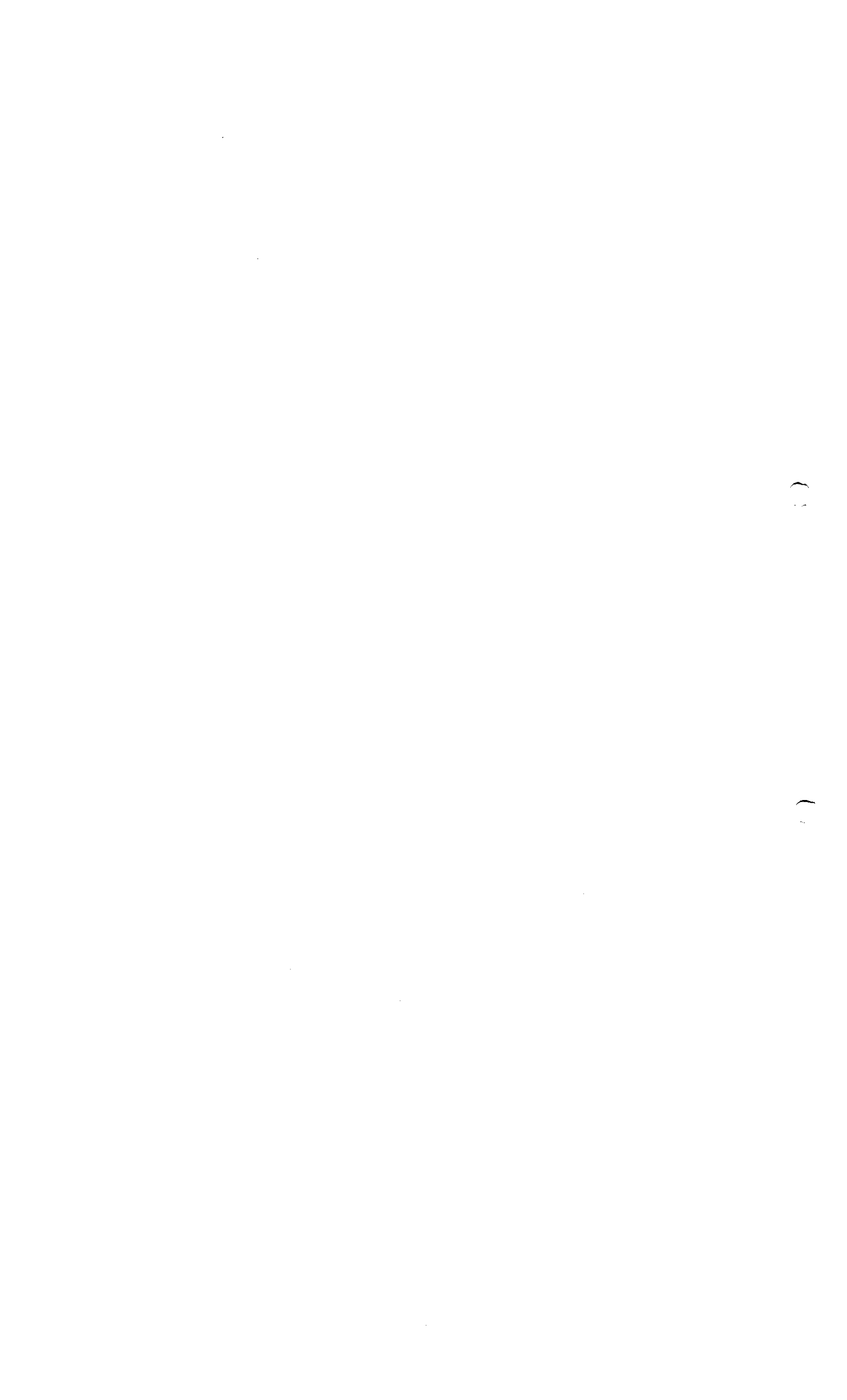
ROXANA MONTEMILONE
DIRECTORA TÉCNICA
SANOFI PASTEUR S.A.

CHRISTIAN DOMINGUEZ
APODERADO
SANOFI PASTEUR S.A.

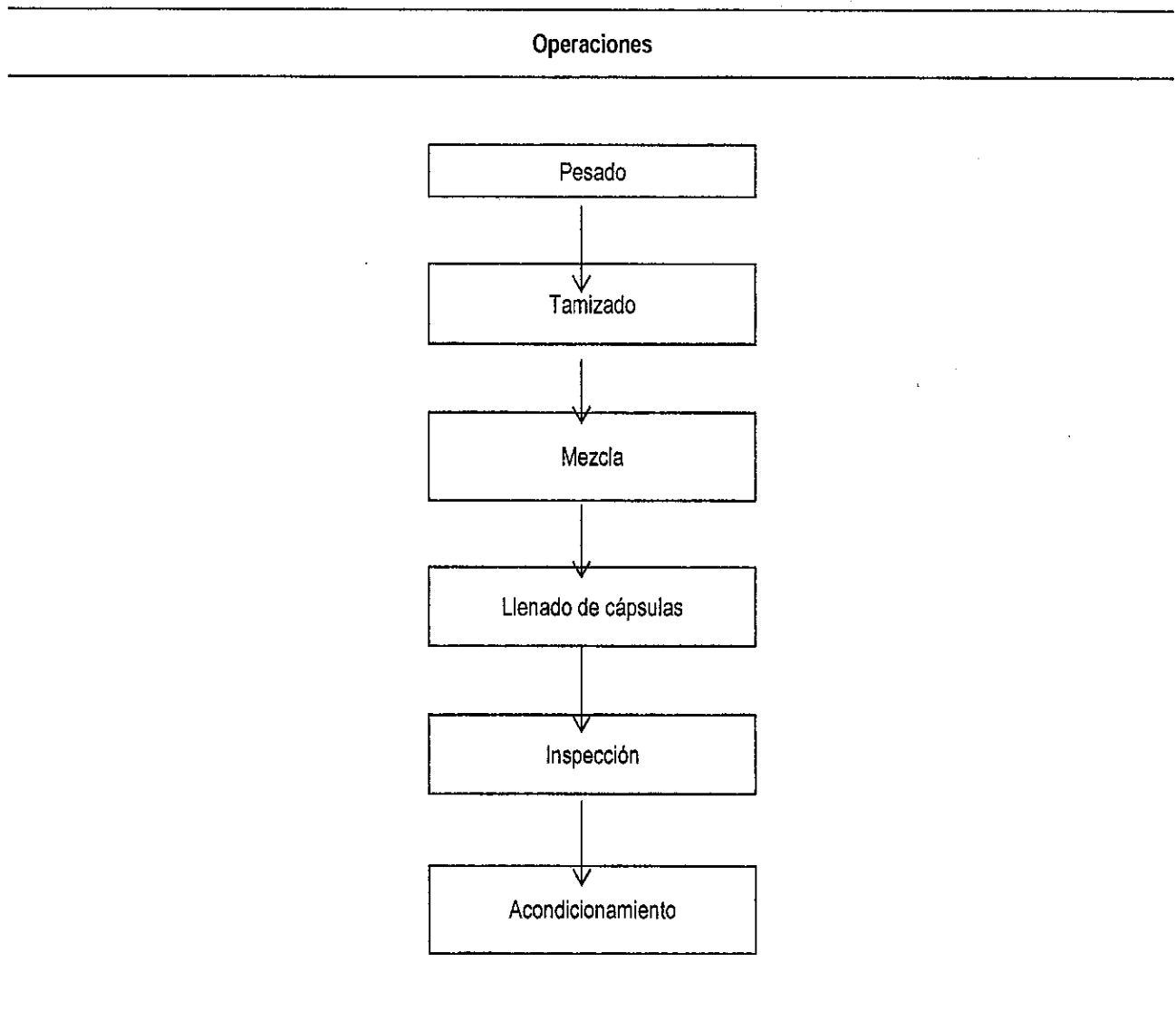
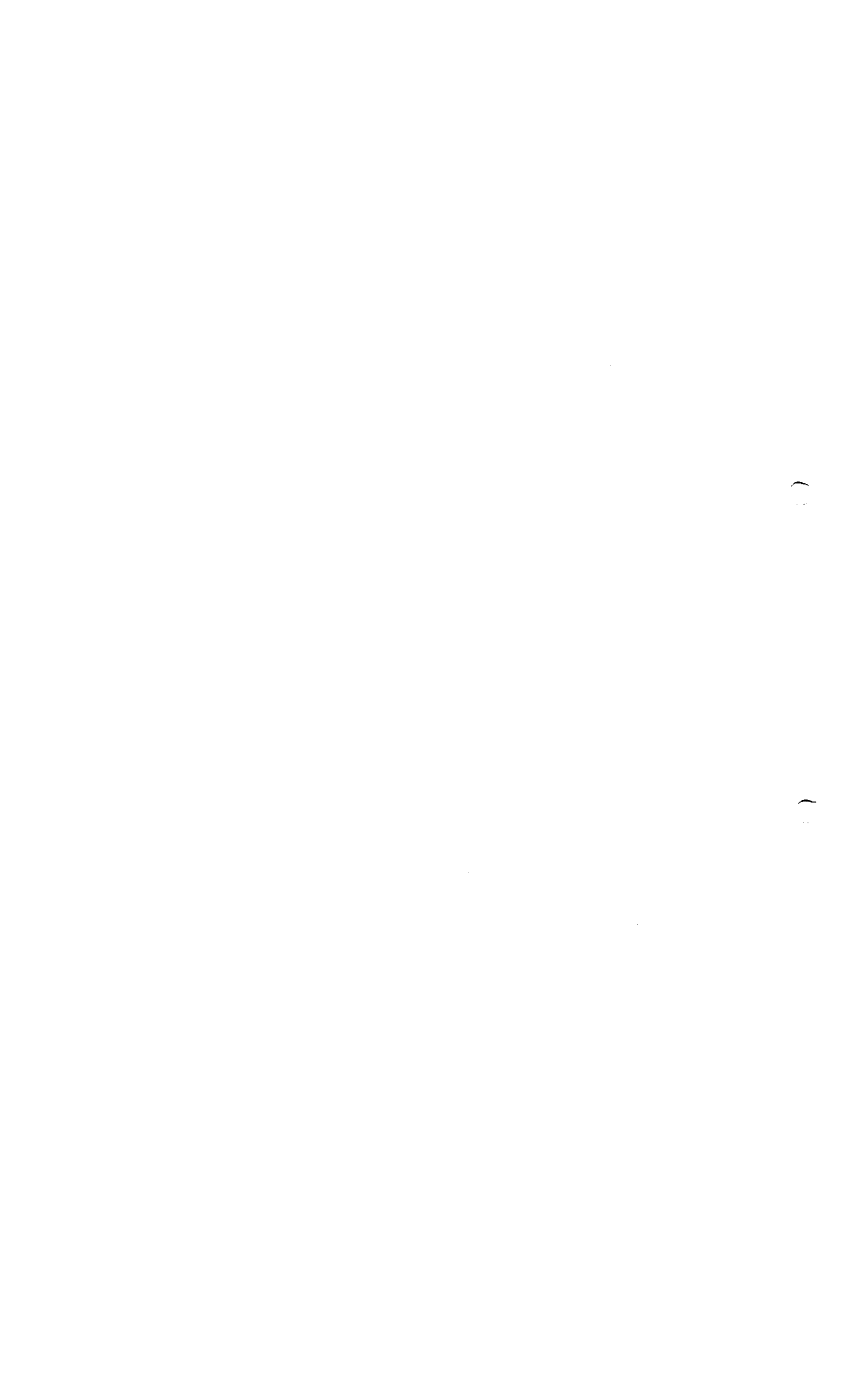

Operaciones

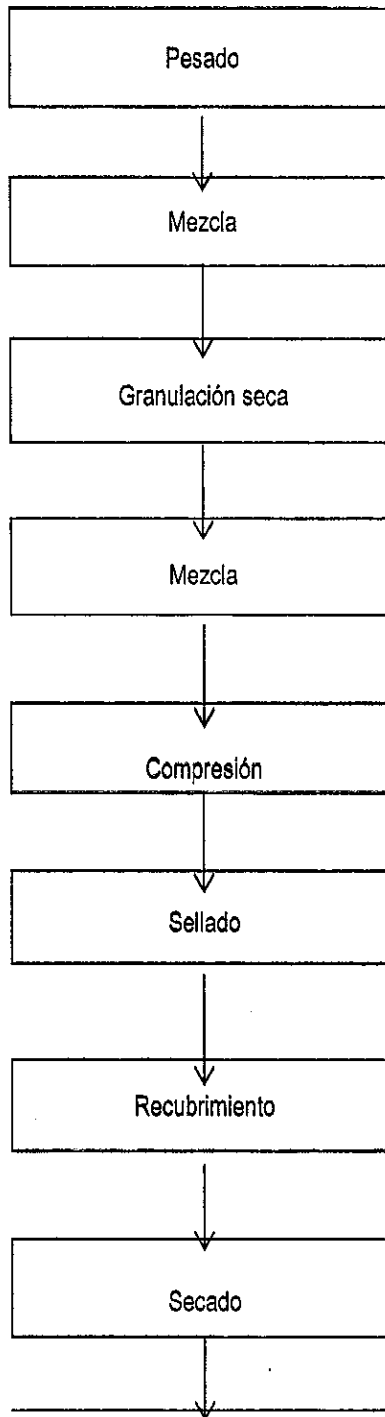

Diagramas de flujo

[Signature]
ROXANA MONTEMILONE
DIRECTORA TÉCNICA
SANOFI PASTEUR S.A

[Signature]
CHRISTIAN DOMINGUEZ
APODERADO
SANOFI PASTEUR S.A

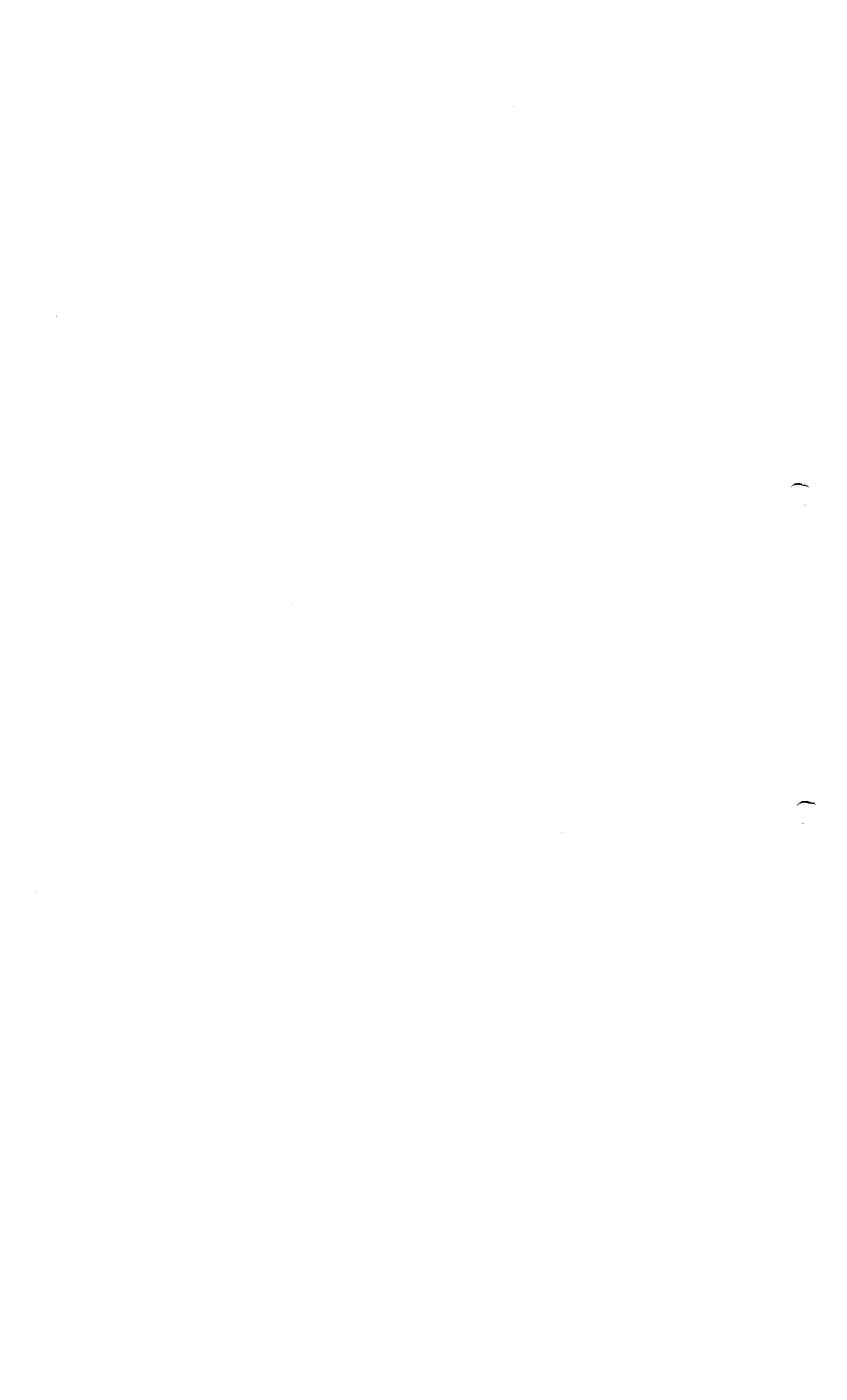



Tabla 3 – Diagrama de flujo de producción de líquidos orales

Diagramas de flujo

[Signature]
LOXANA MONTEMILONE
DIRECTORA TÉCNICA
SANOFI PASTEUR S.A.

[Signature]
CHRISTIAN DOMINGUEZ 4
APODERADO
SANOFI PASTEUR/S.A.

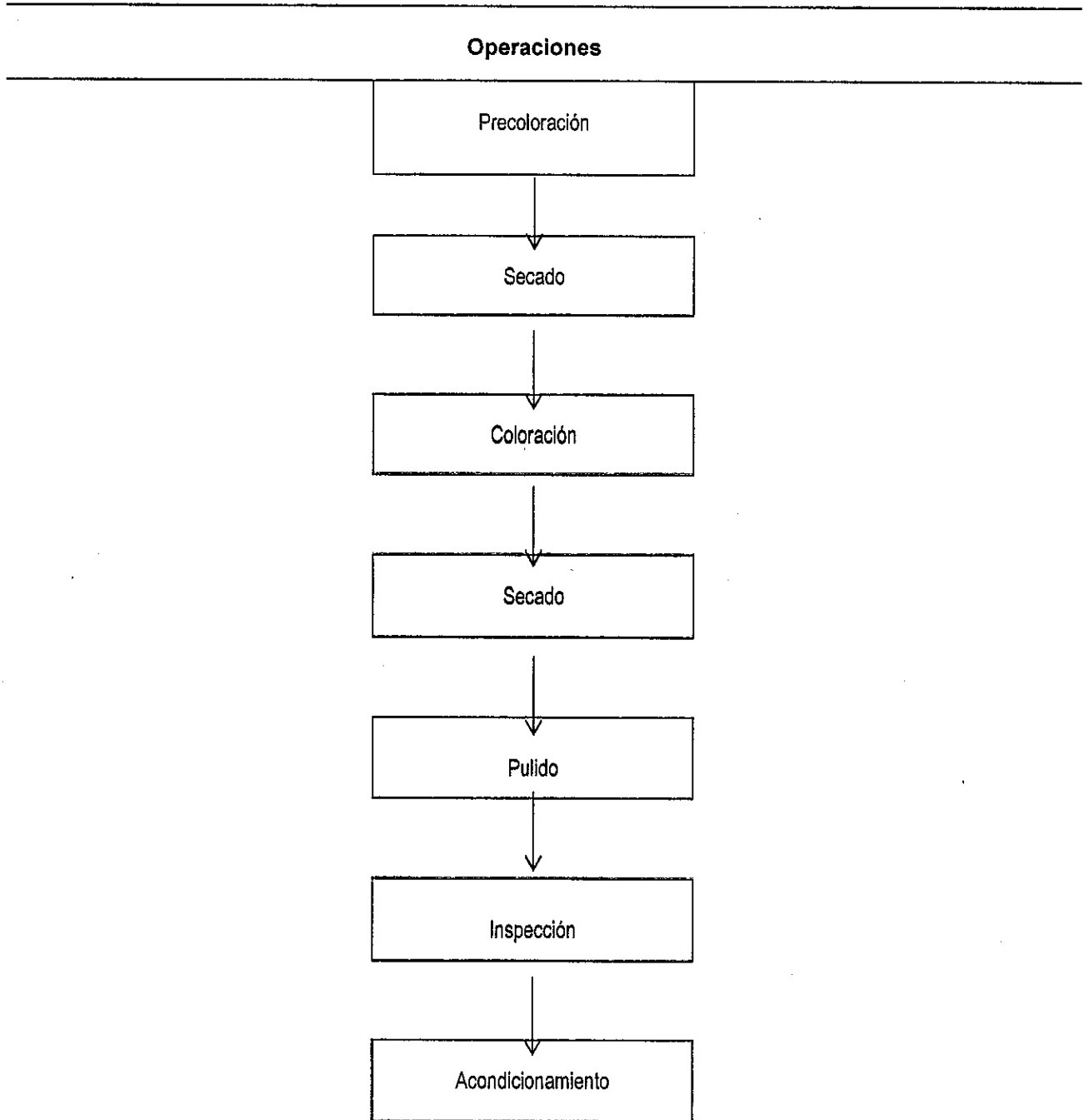
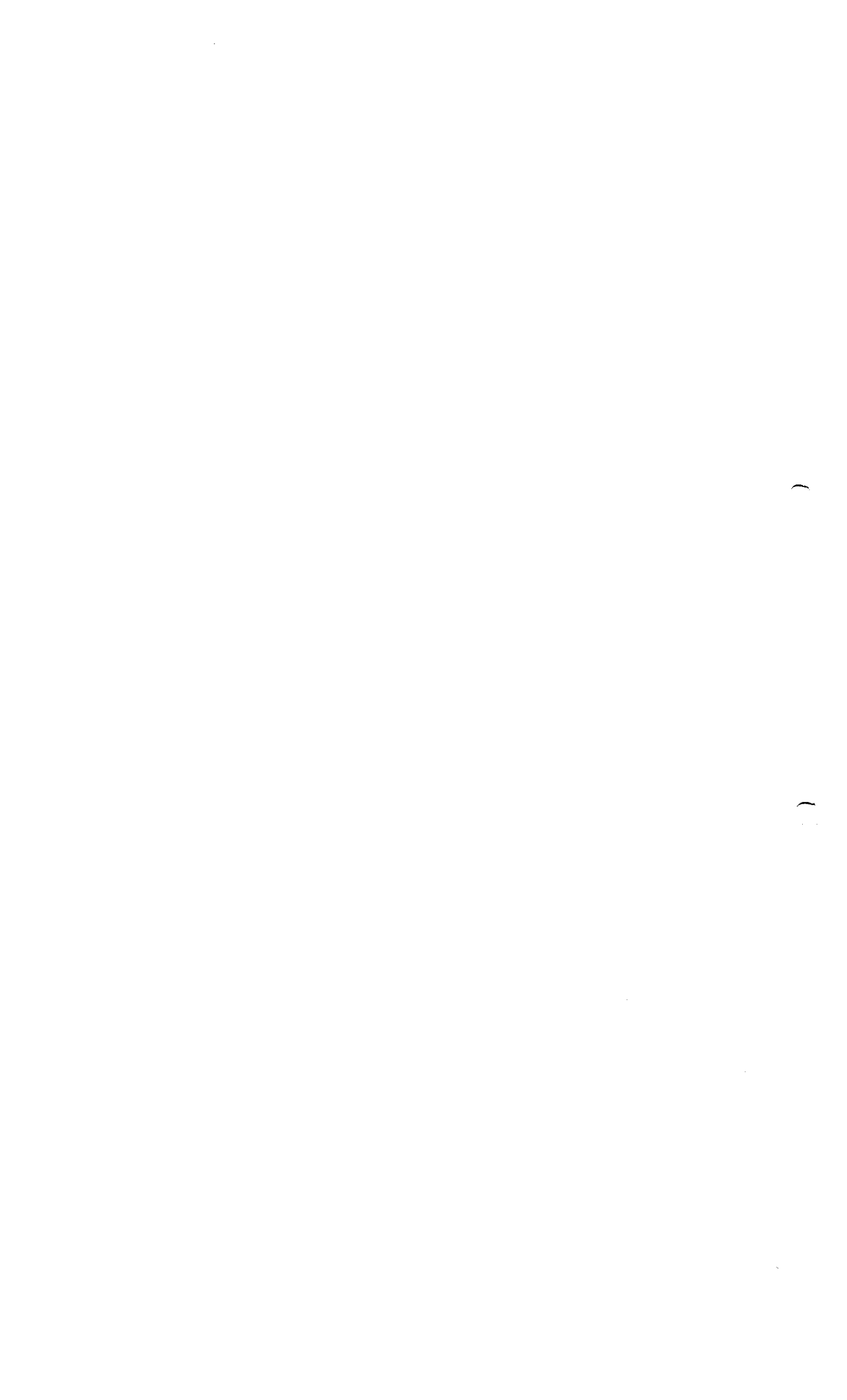

Operaciones



Tabla 4 – Diagrama de flujo de producción de productos estériles líquidos

Diagramas de flujo

ROXANA MONTEMILONE
DIRECTORA TÉCNICA
SANOFI PASTEUR S.A.

CHRISTIAN DOMINGUEZ
APODERADO
SANOFI PASTEUR S.A.

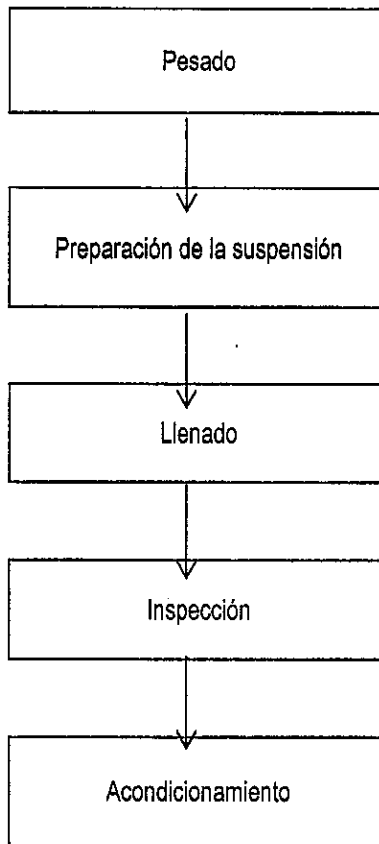
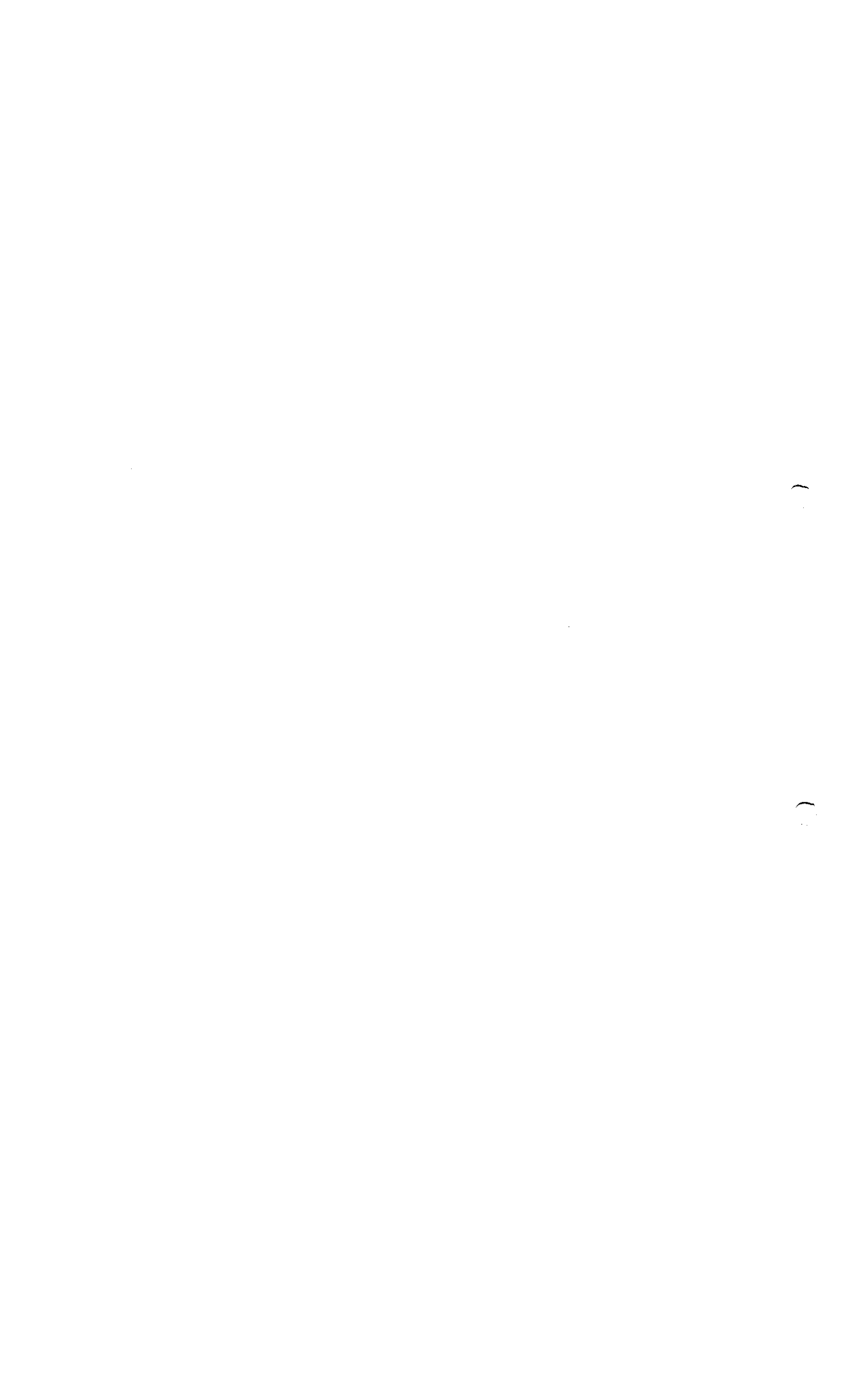



Tabla 5 – Diagrama de flujo de producción de productos estériles liofilizados

Diagramas de flujo

ROXANA MONTEMILONE
DIRECTORA TÉCNICA
SANOPI PARTEIR S.A.

CHRISTIAN DOMINGUEZ
APODERADO
SANOPI PARTEIR S.A.

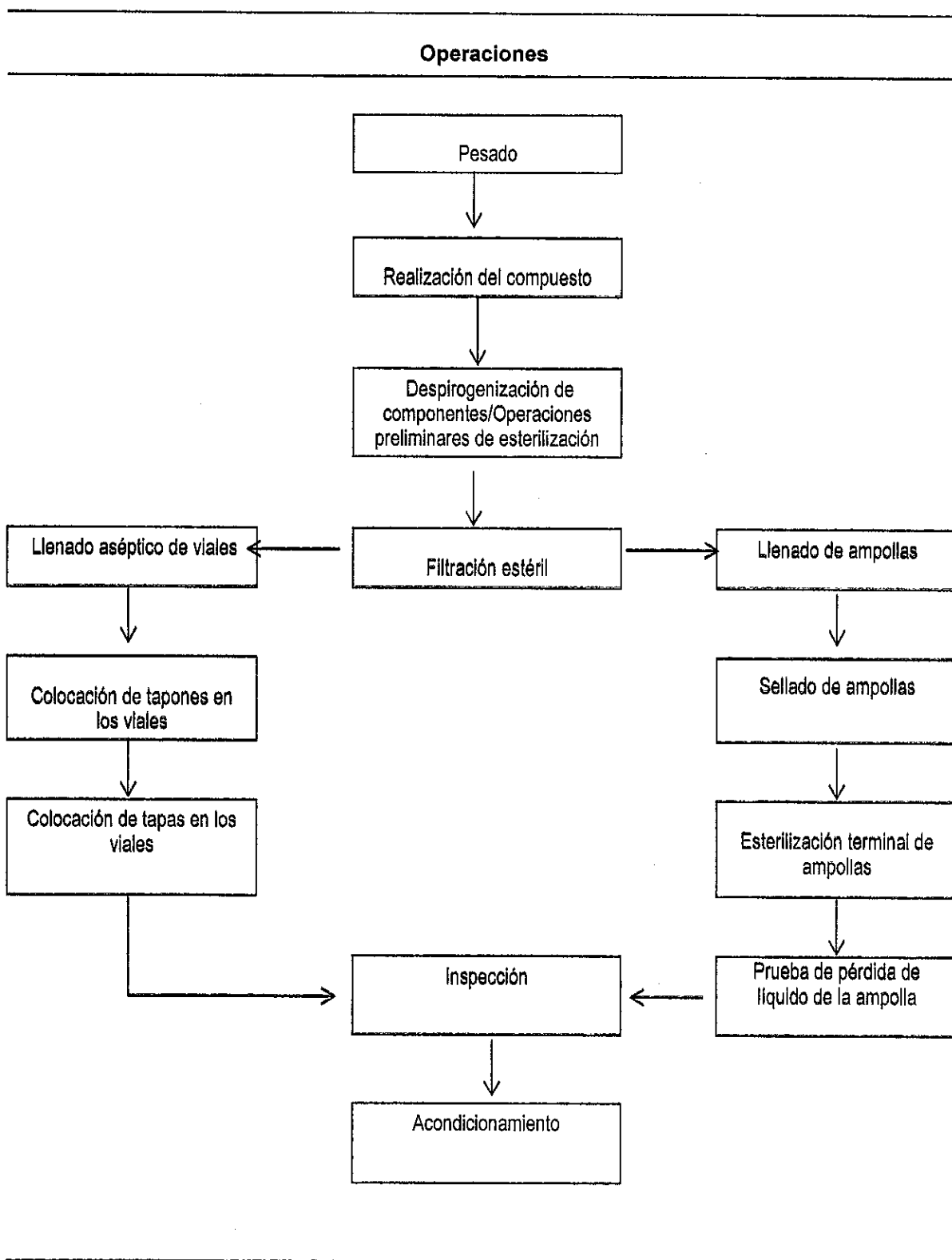

Operaciones

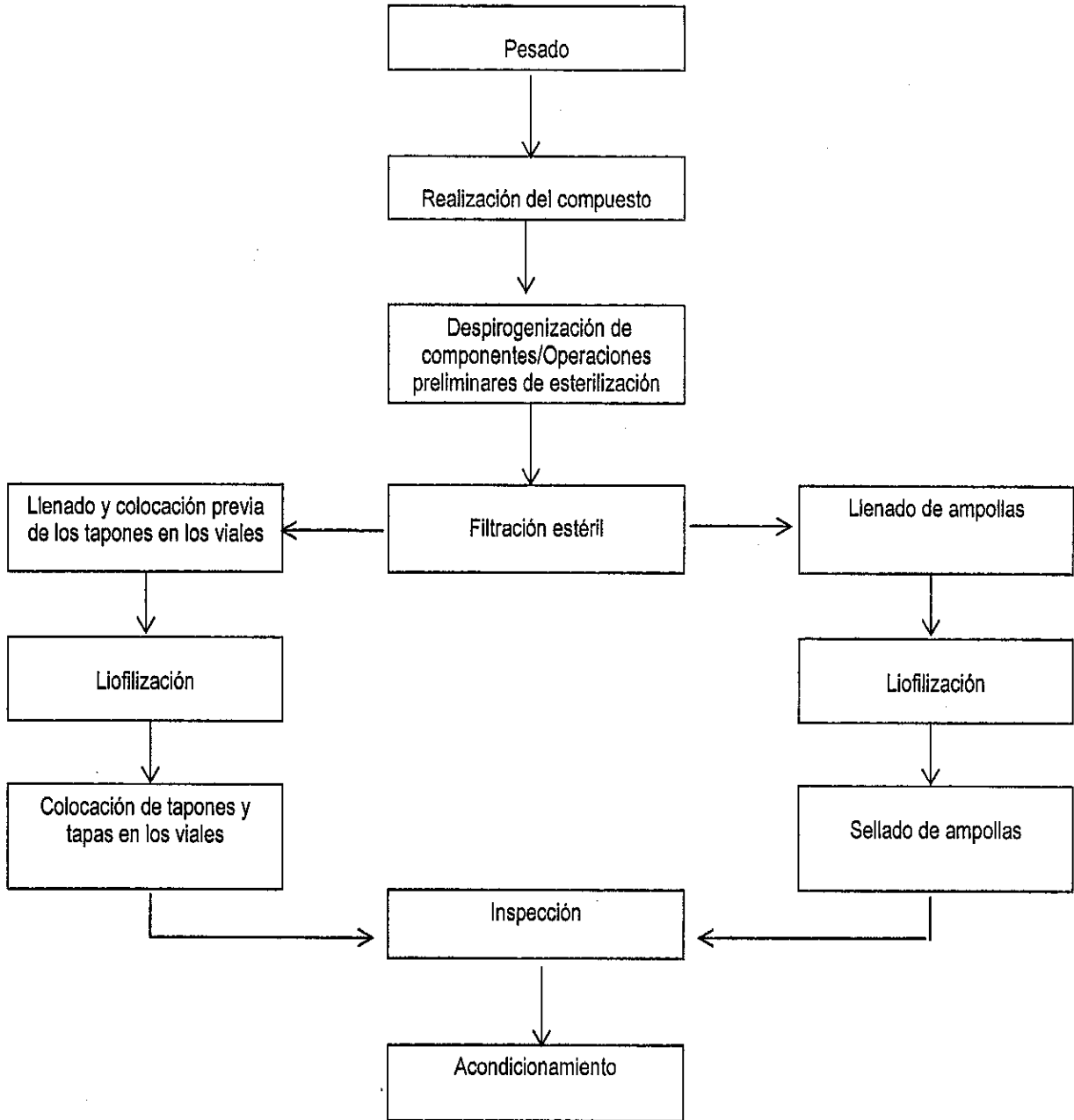

Diagramas de flujo

ROXANA MONTEMILONE
DIRECTORA TÉCNICA
MANIPULACIÓN S.A.

CHRISTIAN DOMÍNGUEZ
APODERADO
MANIPULACIÓN S.A.

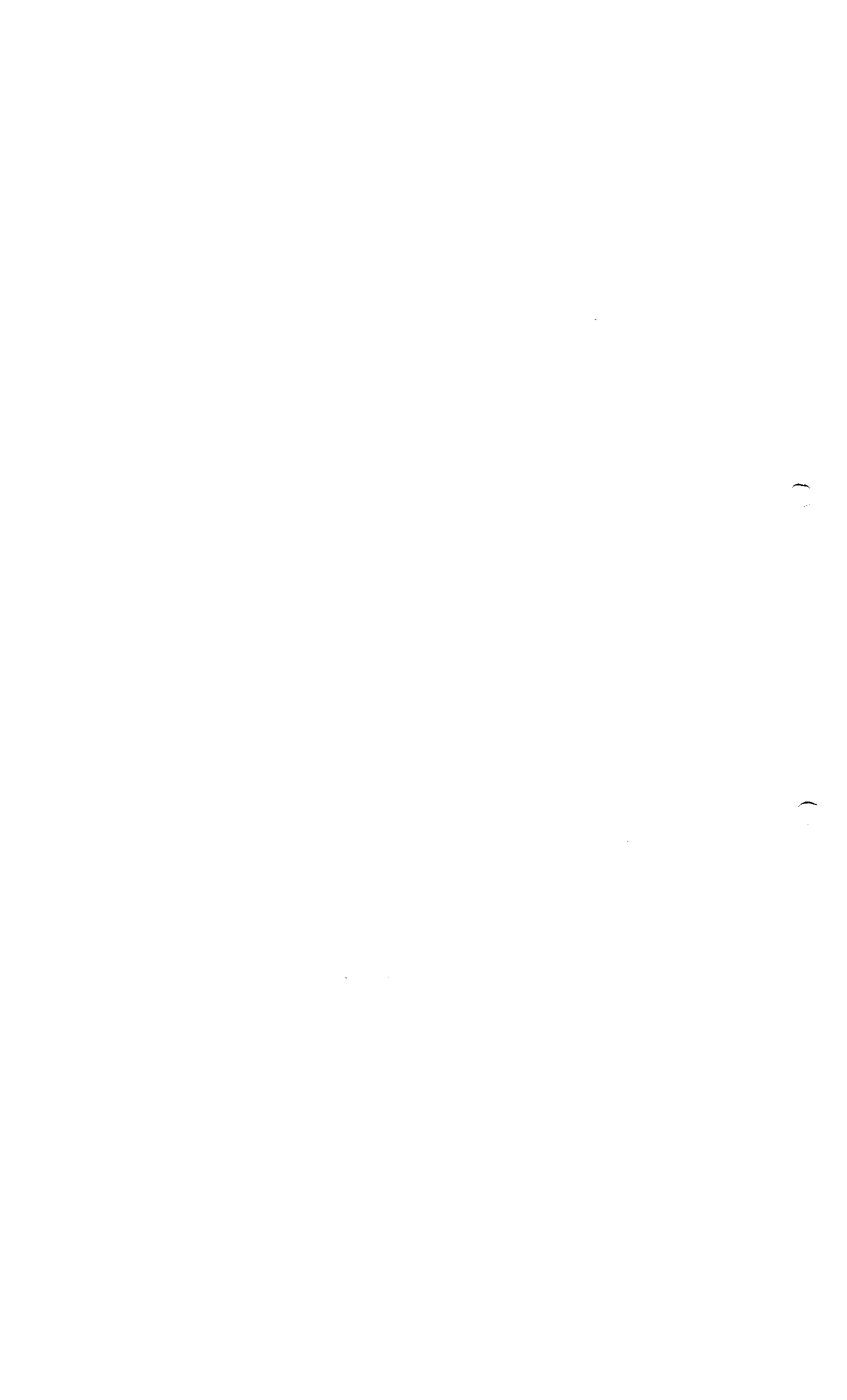

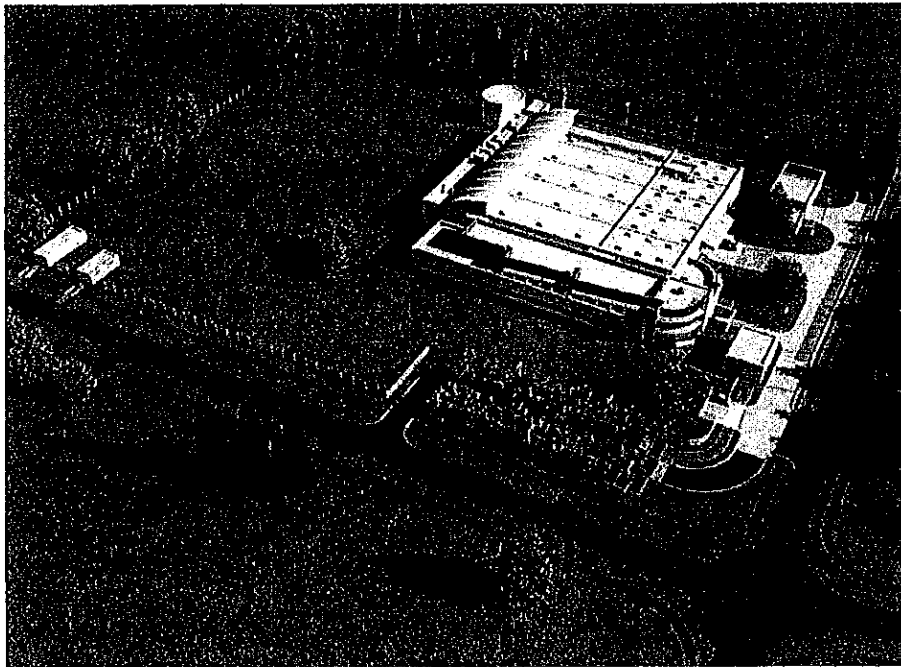

Site Master File

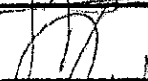
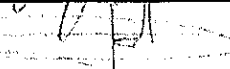

Pilar Site Argentina

	Name	Function	Date	Signature
Author	Consuelo Alvarez	QS & QA Shop Floor Responsible	23 / 06 / 11	
SQO Approval	Roxana Montemilone	SQO Manager	23 / 06 / 2011	
IO Approval	Daniel Alderete	IO Director	23 / 06 / 2011	

Version 07 – Jun. 2011

 ROXANA MONTEMILONE DIRECTORA TÉCNICA SANOFI PASTEUR S.A.	 CHRISTIAN DOMÍNGUEZ DIRECTOR SANOFI PASTEUR S.A.
--	---

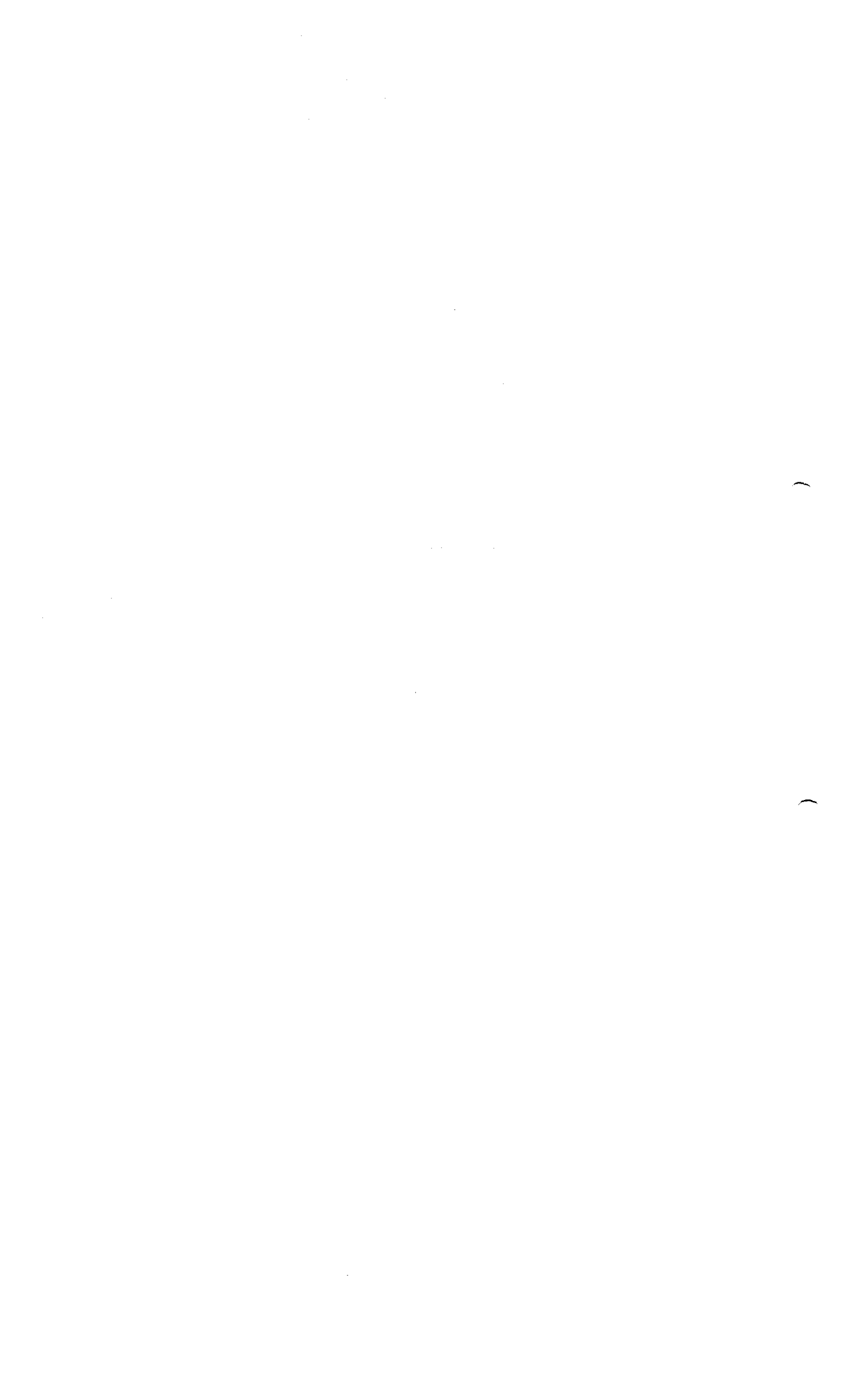



sanofi pasteur

La división vacunas del Grupo sanofi-aventis

CONTENT

1. Introduction
 - 1.1. Pilar Site
 - 1.2. Pilar Site Key Figures
 - 1.3. Main activities in Argentina
 - 1.4. Why are we in Argentina?
 - 1.5. Detailed History of HepB, AL2I production
2. Last Audits
3. Organization & Personnel
 - 3.1. Organization Charts
 - 3.2. Personnel Education Level
4. Zoning & Flows
 - 4.1. Personnel Flow
 - 4.2. Raw Materials, Materials and Flammable Reagents Flow
 - 4.3. Hep B Antigen/Imported Products Flow
 - 4.4. Waste Flow
 - 4.5. Environmental Zoning
 - 4.6. Pressurized Areas
 - 4.7. AHUs Distribution
5. Pharmaceutical Water System Schema
6. Standard Operating Procedures
7. Equipment & Systems
8. Main Activities
 - 8.1. SQO Main Activities
 - 8.1.1. QA Main Activities
 - 8.1.2. QC Main Activities
 - 8.2. Bulk Production Main Activities
 - 8.3. MTECH Main Activities
 - 8.4. Human Resources Main Activities
 - 8.5. Site Services & HSE Main Activities
 - 8.6. Supply Chain Main Activities
9. Hep B Bulk Production Process
10. Validation Master Plan
11. External Contractors
12. Imported Products
13. History of document

ROXANA MONTEMILONE
DIRECTORA TÉCNICA
SANOFI PASTEUR S.A.

CHRISTIAN DOMÍNGUEZ
GERENTE
SANOFI PASTEUR S.A.





sanofi pasteur

La división vacunas del Grupo sanofi-aventis

1. Introduction

ROXANA MONTEMILONE
DIRECTORA TÉCNICA
SANOFI PASTEUR S.A.



CHRISTIAN DOMÍNGUEZ
GERENTE GENERAL
SANOFI PASTEUR S.A.



1.1. Pilar Site

○ Pilar technological park

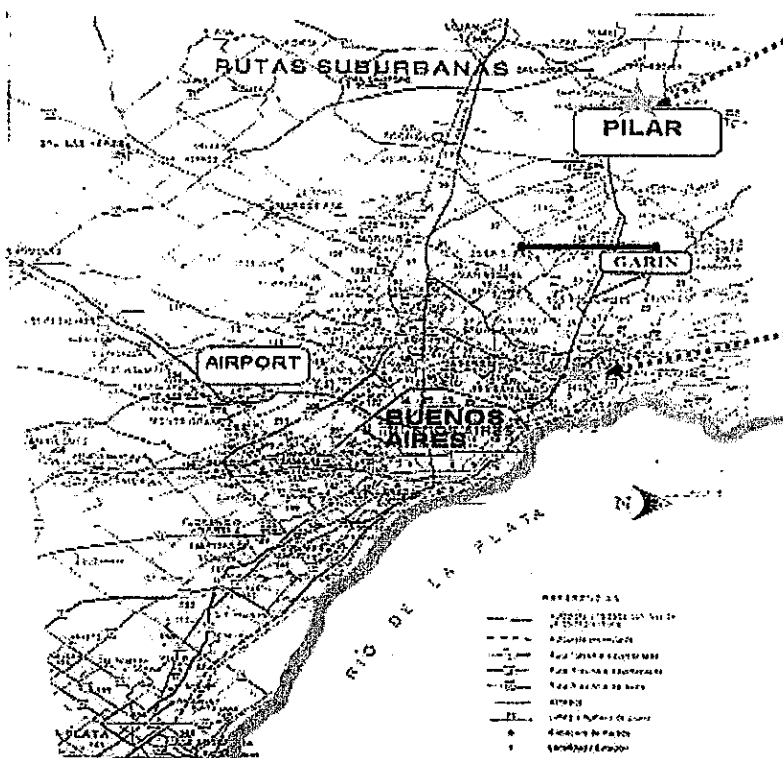
- | Industrial park of 920 ha
- | 60 km away from Capital Federal
- | 3 km from downtown PILAR



OI - PILAR



ComOps - San Isidro



○ Plant site

- | Plot of 25,601 sqm
- | Flat, Services provided (gas and electricity)
- | Autonomous for water production
- | Pilar site is surrounded by:
 - ▶ Atanor – Petrochemistry
 - ▶ Quebecor – Printer
 - ▶ Unilever – Food Industry
 - ▶ Giorlando – Metallurgic
 - ▶ Bayer – Pharmaceuticals

ROXANA MONTEMILONE
 DIRECTORA TÉCNICA
 SANOFI PASTEUR S.A.

CHRISTIAN DOMÍNGUEZ
 GERENTE
 SANOFI PASTEUR S.A.



DEPARTAMENTO S.M.P.
 COPA FIEL
 DE PLANO APRUEBADO
 VERSIÓN ORIGINAL APROBADA
 APROBADA EN ORDEN DE S.M.P.
 SOLICITADO POR: DC
 SECTOR: 04N
 FECHA: 18/03/11

Revisión	Fecha	Observaciones
01	20/10/09	Reemplaza a P-0-AR-003-01 Se agregan modificaciones en PB 4.36 y se actualiza nombre de sala PB 2.17
02	04/01/10	Se actualiza PB 2.12 y PB 2.20 según CCIN 002/09
03	05/11/10	Se reasignan nombres de áreas de depósito (área PB 3.23, PB 3.21, PB 3.2, PB1.25, PB3.16, PB 3.8 y PB 3.12); se elimina la Jaula del Área de Depósito PB 3.15 y se agregan los depósitos de Productos Informales PB 0.24 y de Productos Corrosivos PB 0.25 (actualmente en calificación).
04	14/03/11	Se actualiza layout de planta bajo según CCIN 002/10, CCIN 003/10, CCIN 004/10 y CCIN 005/10.

Planos de Ref.: P-0-AR-001-04 (Planta Baja - São Paulo).DWG
 Archivos: P-0-AR-003-04 (Ubicación de São Paulo).dwg
 Dibujo: JC Revisó: PU Aprobó: [Firma]
 Fecha: 14/03/11 Fecha: 18/03/11 Fecha: 18/03/11

sanofi pasteur
 La salud comienza en el Grupo Sanofi-Aventis
 Ubicación de São Paulo
 Escala: N/A
 P-0-AR-003
 04/03/11

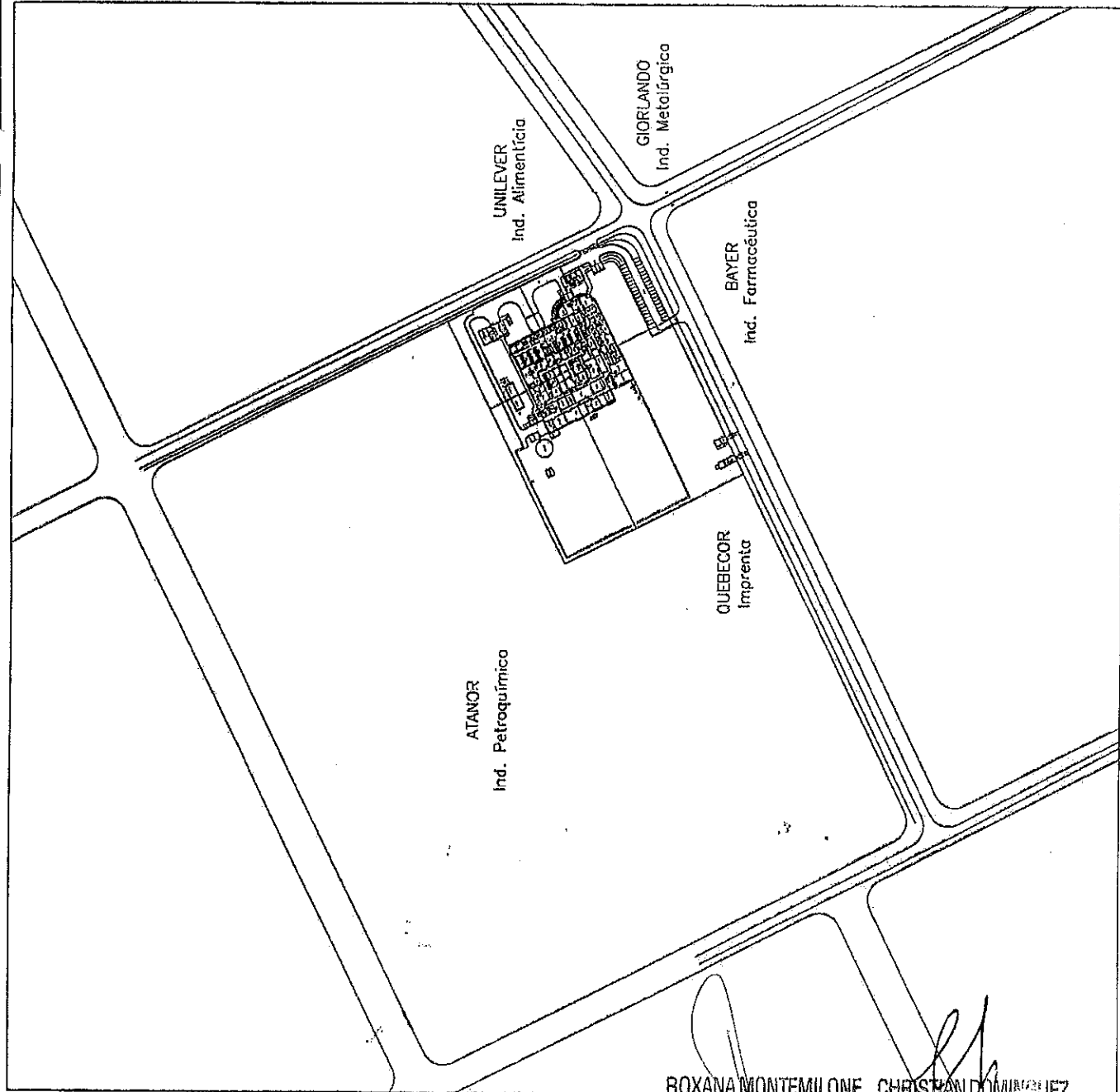

ROXANA MONTEMILONE DIRECTORA TÉCNICA SANOFI PASTEUR S.A.
 CHRISTIAN DOMÍNGUEZ DIRECTOR GENERAL SANOFI PASTEUR S.A.

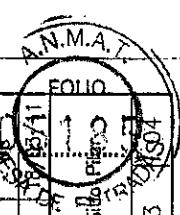

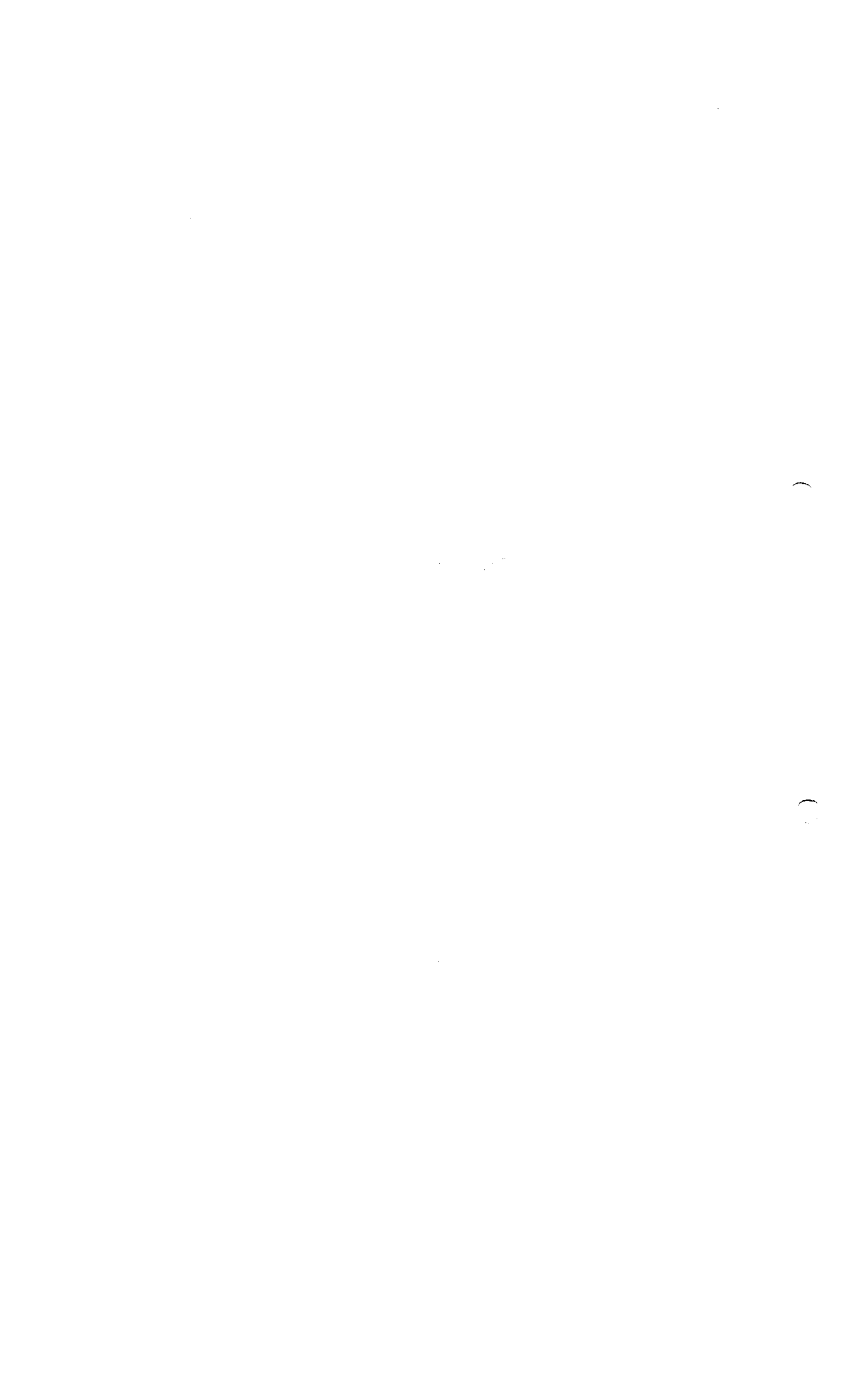

sanofi pasteur

La división vacunas del Grupo sanofi-aventis

Plant

- | 6.268 sqm floor area
 - ▼ Production building: 1.761 sqm
 - ▼ Warehouse: 1.150 sqm
 - ▼ Utilities: 1824 sqm
 - ▼ QC labs: 468 sqm
 - ▼ QC extension: 326,44 sqm

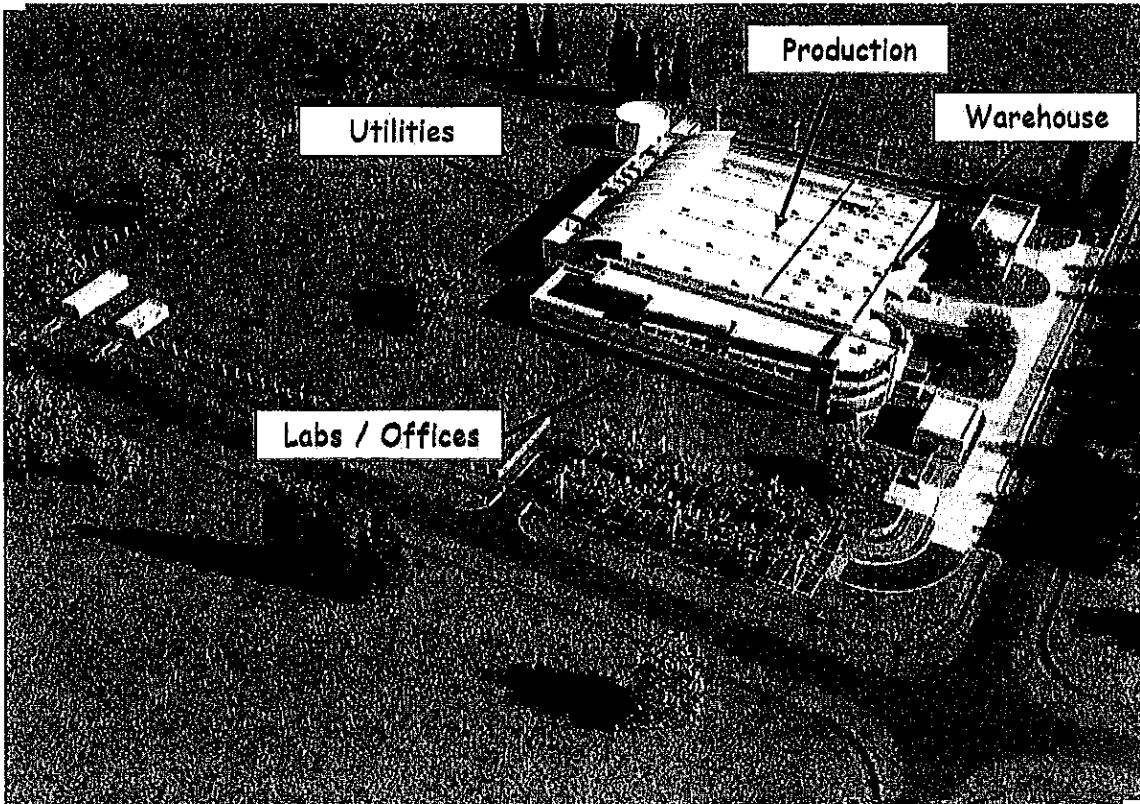

Roxana Montemilone
ROXANA MONTEMILONE
DIRECTORA TÉCNICA
SANOFI PASTEUR S.A.

Christian Domínguez
CHRISTIAN DOMÍNGUEZ
GERENTE
SANOFI PASTEUR S.A.



REFERENCIA	DESCRIPCIÓN
	Zona de Servicios
	Zona de Producción
	Zona de Depósito
	Zona de Laboratorios de Control

DEPARTAMENTO S.M.P.
 COPIA FIEL
 DE PLANO APROBADO
 VERIFICAR SIGNA, APROBADA
 APROBADA EN OFICINA DE D.E.A.
 CONSULTAR P. 2.17 DC
 SECCION: 0147
 FECHA: 16/03/11

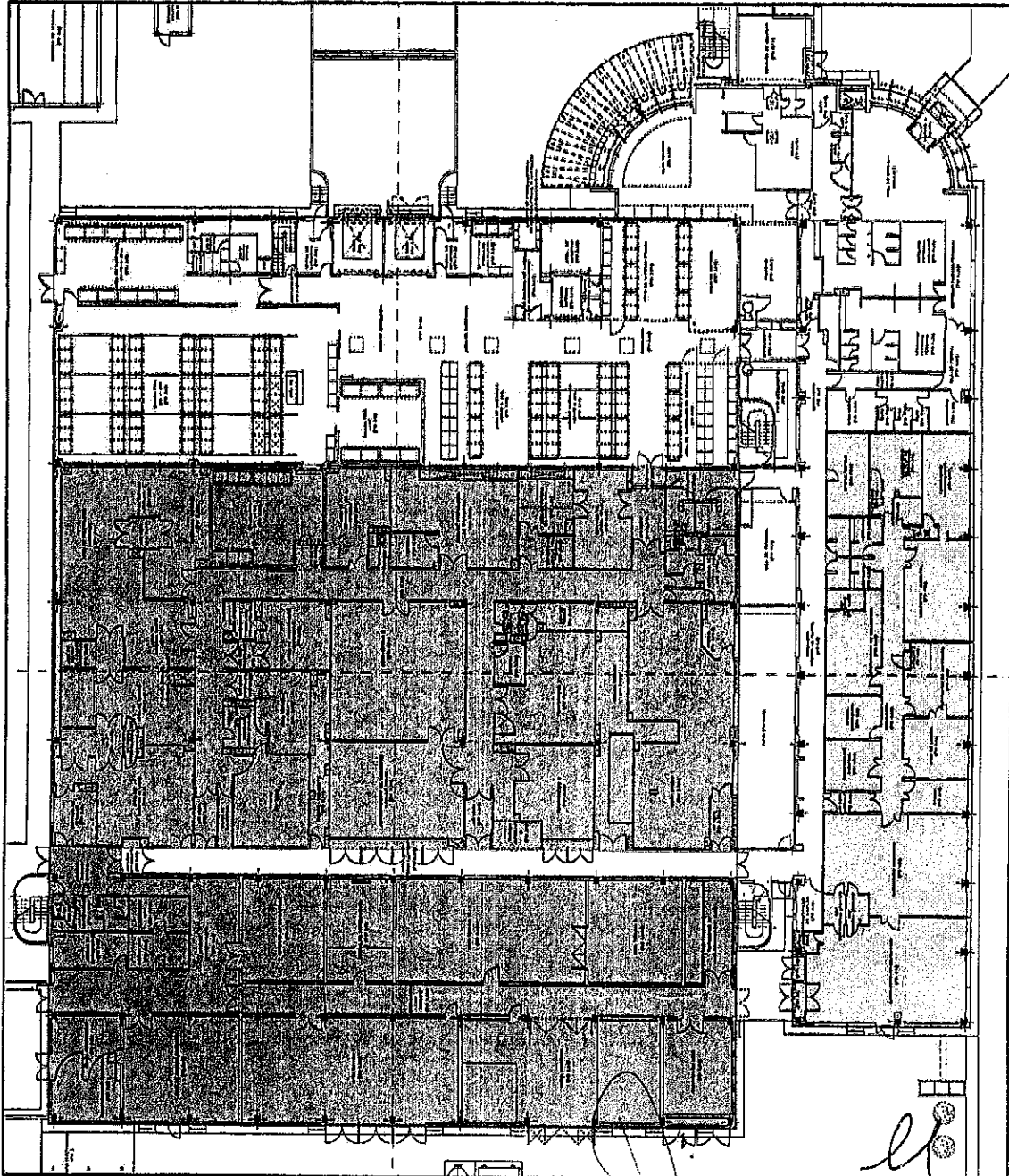

Revisión	Fecha	Observaciones
01	30/10/09	Se agregan modificaciones en PB 4.36 y se actualiza nombre de sala PB 2.17
02	04/01/10	Se actualiza PB 2.12 y PB 2.20 según CCN 002/08
03	05/11/10	Se reasignan nombres de áreas de depósito (Área PB 3.23, PB 3.21, PB 3.2, PB3.25, PB3.16, PB 3.8 y PB 3.12); se elimina la Jaula del Área de Depósito PB 3.15. Se incorpora PB2.12 como área producción.
04	14/03/11	Se actualiza layout de planta bajo según CCN 002/10, CCN 003/10, CCN 004/10 y CCN 005/10.

Planos de Ref.: P-0-AR-001-04 (Planta Baja - Sitio Pilar).DWG
 Archivo: P-0-AR-004-04 (Distribución de Áreas - Sitio Pilar).DWG
 Dibujó: JC
 Revisó: PU
 Aprobó: DC
 Fecha: 14/03/11
 Fecha: 16/03/11
 Fecha: 16/03/11

sanofi pasteur
 La División Sanofi Pasteur de Argentina, S.A. y sus filiales.
 Distribución de Áreas
 Sitio Pilar
 Escala: N/A
 Código: P-0-AR-004

A.N.M.A.T.
 FOLIO
 006187

ROXANA MONTEMILONE DIRECTORA TÉCNICA
 SANOFI PASTEUR S.A.
 CHRISTIAN DOMESTRUEZ GERENTE
 SANOFI PASTEUR S.A.



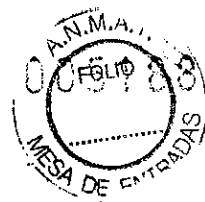

sanofi pasteur

La división vacunas del Grupo sanofi-aventis

1.2. Pilar Site Key Figures

① CAPEX

[AED 23,9 MEuros

① Headcount

[June 2011 → Approved Headcount: 80
[TPW : 5

① Production capacity

[3 fermentations lines of 50 liters
[Maximum capacity: 150 batches / year – 60 millions doses
[Actual capacity: 40 batches / year

① Work Schedule

[1 shift: 8h to 16h30
[5 / 7



ROXANA MONTEMILONE
DIRECTORA TÉCNICA
SANOFI PASTEUR S.A.

CHRISTIAN DOMÍNGUEZ
GERENTE
SANOFI PASTEUR S.A.

1.3. Main activities in Argentina

• Bulk Production: Hep B

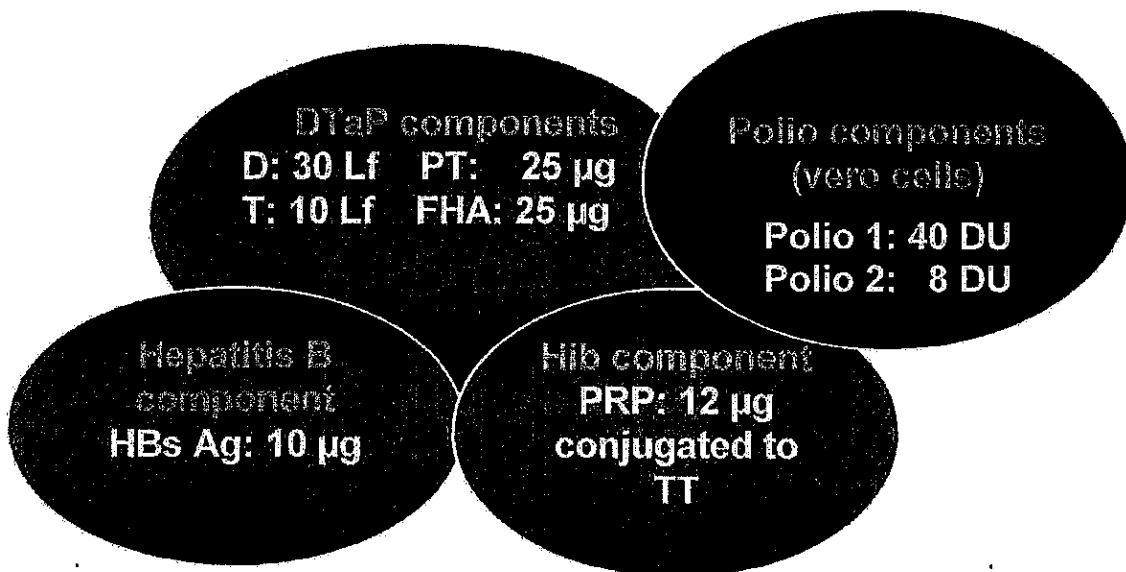
- | Hep B production for AL2i (Hexaxim) → 60 millions doses
- | Ready to use, preservative-free, liquid formulation, combining all 9 antigens in 0.5 mL



• Imported Products* (directly linked to Argentinean ComOps activities)

- | Distribution
- | Repackaging
- | Quality Control

*see chapter 12 "Imported products"

ROXANA MONTEMILONE
DIRECTORA TÉCNICA
SANOFI PASTEUR S.A.

CHRISTIAN DOMÍNGUEZ
GERENTE
SANOFI PASTEUR S.A.





sanofi pasteur

La división vacunas del Grupo sanofi-aventis

1.4. Why are we in Argentina?

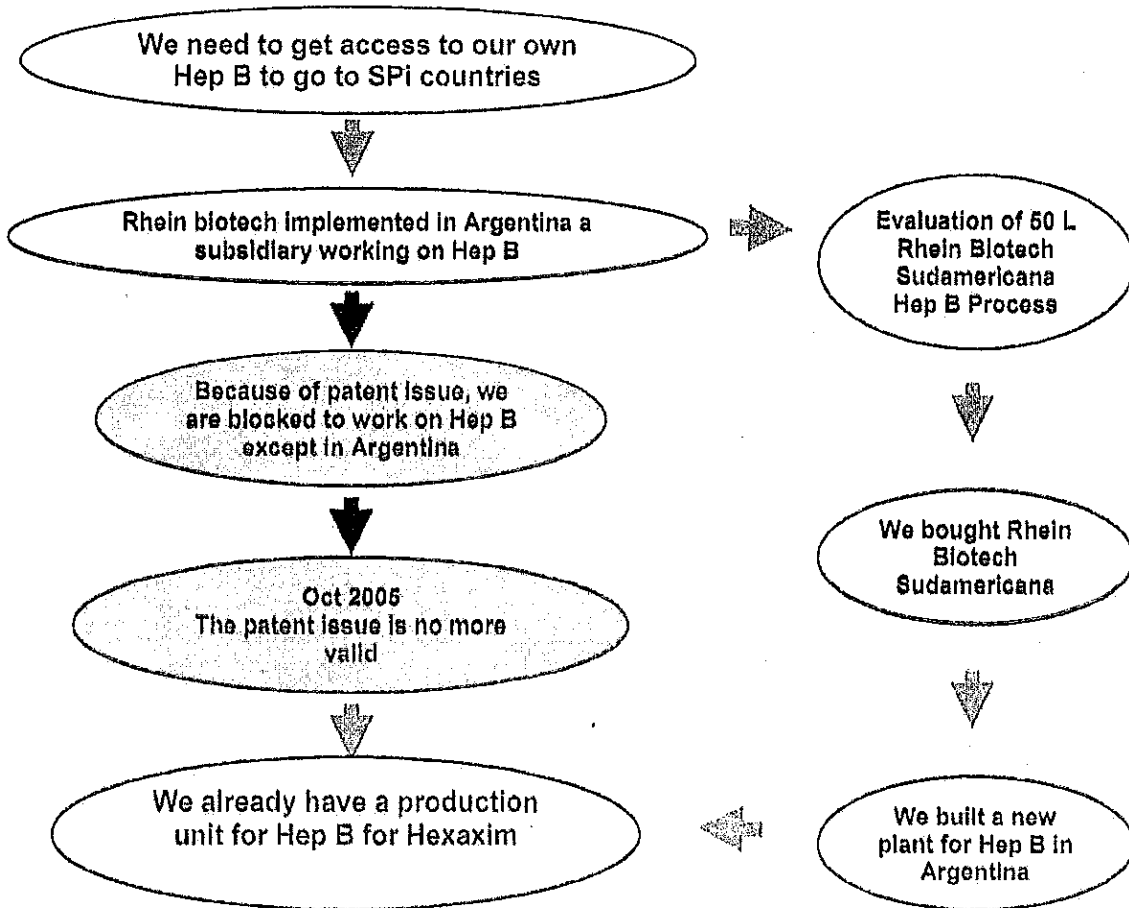



ROXANA MONTEMILONE
DIRECTORA TECNICA
SANOFI PASTEUR S.A.

CHRISTIAN DOMINGUEZ
GERENTE
SANOFI PASTEUR S.A.

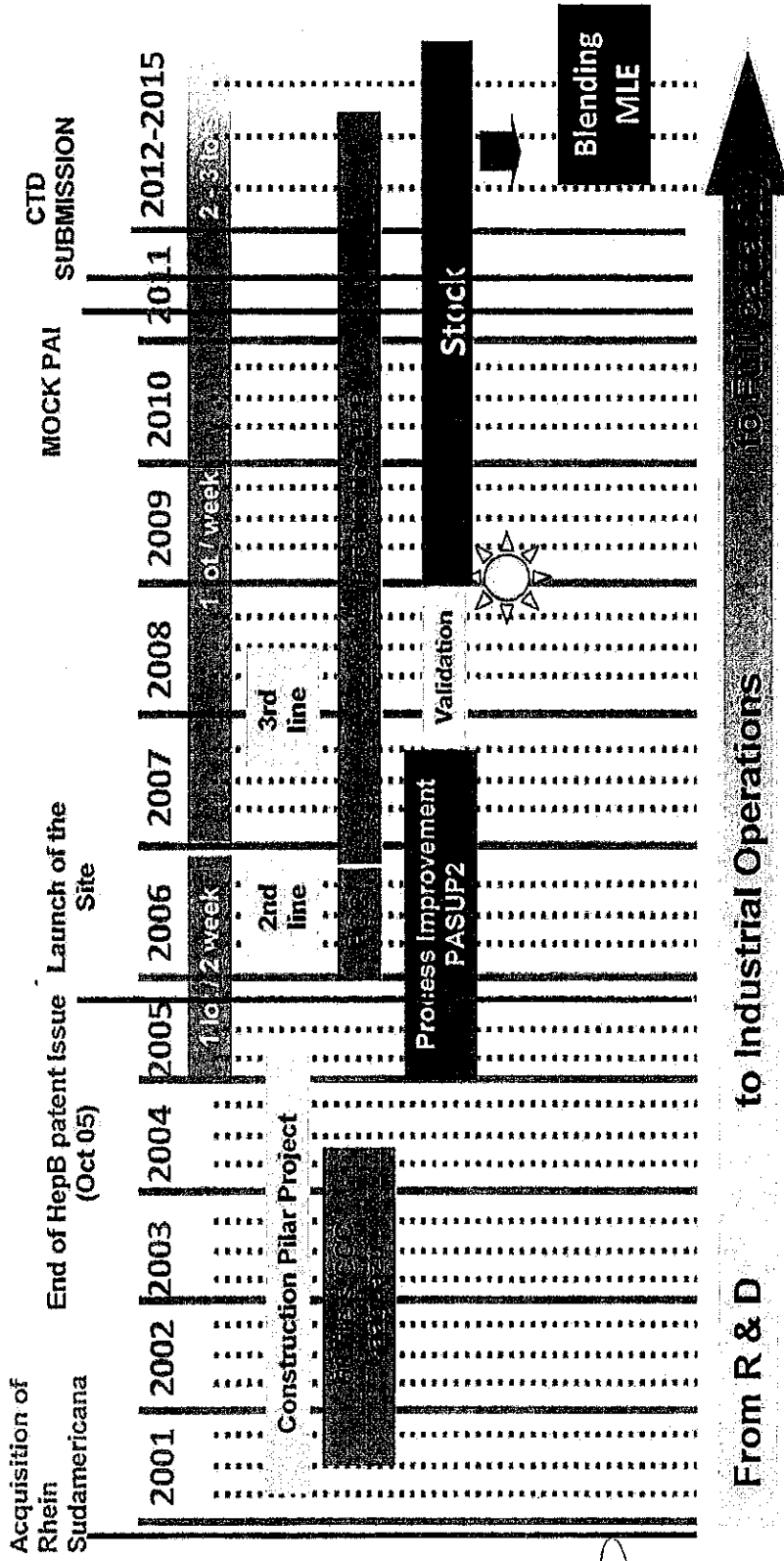

1.5. Detailed History of HepB, AL2i production



ROXANA MONTEMILONE
DIRECTORA TÉCNICA
SANOFI PASTEUR S.A.

CHRISTIAN DOMÍNGUEZ
GERENTE GENERAL
SANOFI PASTEUR S.A.

