

Digital Sound Level Meter

Model SL510

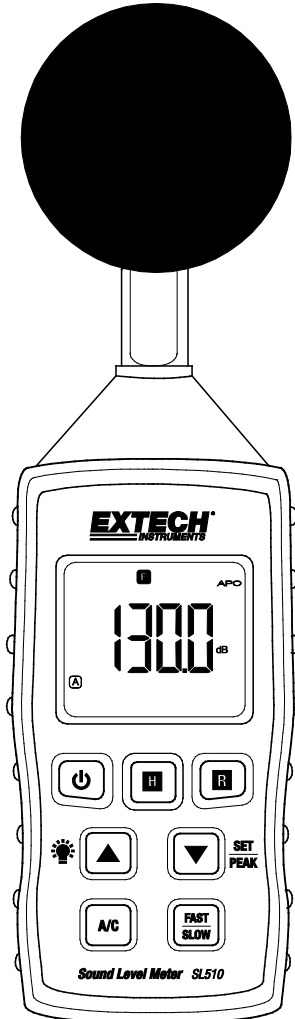

Introduction

Thank you for selecting the Extech Model SL510. The SL510 measures sound levels in decibels. This device is shipped fully tested and calibrated and, with proper use, will provide years of reliable service. Please visit our website (www.extech.com) to check for the latest version and translations of this User Manual, Product Updates, Product Registration, and Customer Support.

Features

- Standard 0.5" microphone head
- A/C frequency weighting
- LCD with backlight
- Light weight, compact design
- Wristlet for convenient, one-handed operation

Safety

Please read the entire Quick Start and User Manual before operating this device. Use the meter only as specified and do not attempt to service or open the meter housing. Do not allow children to handle the meter or the windscreen. Please dispose of batteries and meter responsibly and in accordance with all applicable laws and regulations.

Meter Description

1. Microphone with windscreen
2. LCD Display
3. ON-OFF button
4. LCD Backlight button and ▲ button
5. A/C weighting selection button
6. Hold button
7. Max/Min Record button
8. SET, Peak capture and ▼ button
9. Fast/Slow response selection button

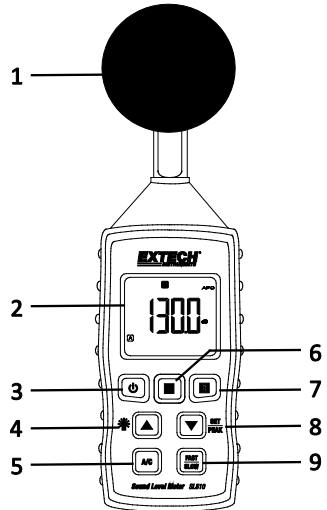



Measurement Considerations

1. Wind blowing across the microphone increases the noise measurement. Use the supplied windscreen to cover the microphone when applicable.
2. Calibrate the instrument before each use if possible. Especially if the meter has not been used for a long period of time.
3. Do not store or operate the instrument in areas of high temperature or humidity.
4. Keep meter and microphone dry.
5. Avoid severe vibration.
6. Remove the battery when the meter is to be stored for long periods of time.

Operation



1. Power the meter by pressing the  power button. The meter will begin displaying sound level readings. If the LCD does not switch on, check the batteries located in the rear battery compartment.
2. Hold the meter in hand facing the microphone toward the source of the sound to be measured.
3. View the measurement on the meter's LCD

'A' and 'C' Frequency Weighting

Press the **A/C** button to select A or C frequency weighting. The  or  icon will appear in the display to indicate the weighting selected.



With 'A' weighting selected, the frequency response of the meter is similar to the response of the human ear. 'A' weighting is commonly used for environmental or hearing conservation programs such as OSHA regulatory testing and noise ordinance law enforcement. 'C' weighting is a much flatter response and is suitable for the sound level analysis of machines, engines, etc. Most noise measurements are performed using 'A' Weighting and FAST Response.

'FAST' and 'SLOW' Time Weighting

Use the  button to select FAST (125 ms) or SLOW (1 second) time weighting. The  or  icon will appear in the display as selected.

Select FAST to capture noise peaks and noises that occur very quickly. Select the SLOW response to monitor a sound source that has a consistent noise level or to average quickly changing levels. Select FAST response for most applications.

Data Hold

To freeze a displayed reading, press the  button. The  icon will appear and the most recent reading will appear in the display. Press the  button to exit the mode and return to normal operation

Backlight

The LCD is equipped with backlighting for easier viewing, especially in dimly lit areas. Press the  backlight button to turn the backlight on. The backlight will automatically turn off after 10 seconds.

Peak Hold









The Peak mode is used to capture and hold the peak sound level measurement.

1. Press the ▼ SET/PEAK button to enable the peak capture mode. The peak icon  will appear on the display.
2. The meter will now display the highest peak reading during the measurement period.
3. Press the ▼ SET/PEAK button to exit the peak capture mode

MAX-MIN Recording

In this mode, the meter records the maximum and minimum values over time.

Note: A/C, Fast/Slow, Hold and the Power buttons are not operational in the Record mode.

1. Short press the  button to enter the Record mode. The  record icon will appear on the display. The maximum and minimum values will be recorded and updated during the measurement period.
2. Short press the  button to stop the Max-Min recording. The  icon and the MAX value that occurred during the recording period will be displayed.
3. Short press the  button to display the  icon and the MIN value that occurred during the recording measurement period.
4. Short press the  button to clear the memory and start a new max/min measurement period.
5. Long press the  button to exit the record mode.

Auto Power OFF (APO)

In order to conserve battery life, the meter will automatically shut off after approximately 10 minutes of inactivity. The APO icon is active in the display when APO is selected.

To turn APO ON or OFF as the default condition:

1. Press and Hold the ▼ button for 2 seconds. The yes or no icon will appear:

 

2. Press the ▲ button to turn the APO ON (YES) or press the ▼ button to turn the APO OFF (NO).
3. Press the  button to save the selection.
4. Short press the power button or wait approximately 10 seconds for the meter to return to normal operation.

Note: APO is not operational in the Record mode.

Calibration

To calibrate the SL510, an external calibrator that can provide a 94.0dB signal at 1 kHz is required.

1. Turn the meter ON
2. Put the meter in the 'A' weighting mode.
3. Put the meter in the 'FAST' response mode.
4. Place the microphone into the calibrator. Set the calibrator to output a 1kHz sine wave @ 94dB.
5. When the reading is stable, simultaneously press and hold the A/C and Fast/Slow buttons until a second lower dB display appears.
6. Press the ▼ or ▲ buttons to adjust the upper display to match the calibrator output (94.0dB).
7. Press the  button to save the calibration and return to normal operation.



94.0
93.8

Maintenance



WARNING: To avoid electrical shock, disconnect the meter from any circuit and turn OFF the meter before opening the case. Do not operate with an open case.

Battery Replacement

1. Power OFF the meter.
2. Remove the flat head screw that secures the battery compartment at the back of the meter.
3. Open the battery compartment and replace the 3 AAA batteries observing correct polarity. Re-assemble the meter before use

Safety: Please dispose of batteries responsibly; never dispose of batteries in a fire, batteries may explode or leak. If the meter is not to be used for 60 days or more, remove the battery and store separately.



Never dispose of used batteries or rechargeable batteries in household waste.

As consumers, users are legally required to take used batteries to appropriate collection sites, the retail store where the batteries were purchased, or wherever batteries are sold.

Disposal: Do not dispose of this instrument in household waste. The user is obligated to take end-of-life devices to a designated collection point for the disposal of electrical and electronic equipment.

Cleaning and Storage

Periodically wipe the case with a damp cloth and mild detergent; do not use abrasives or solvents.

Specifications

Display	Backlit LCD
Microphone	0.5" Electret condenser
Input Overload Display	"----"
Measurement Range	35 to 130dB
Resolution	0.1dB
Frequency weighting	'A' and 'C' (selectable)
Accuracy / Resolution	± 1.0 dB @ 1kHz / 0.1dB
Frequency	31.5 to 8000 Hz
Response time	Fast: 125 milliseconds / Slow: 1 second
Calibration source required	1KHz sine wave @ 94dB
Tripod mount	On back of meter
Power	3 x 1.5V AAA batteries
Power Consumption	Approx. 7.2mA DC
Automatic power off	After approx. 10 minutes of inactivity
Operating temperature	0 to 50°C (32 to 122°F)
Operating humidity	10 to 80% RH
Storage temperature	-10 to 60°C (14 to 140°F)
Storage humidity	10 to 75% RH
Dimensions/weight	167 x 57 x 25mm (6.6 x 2.3 x 1.1") /146g (5.1oz)
±1dB high accuracy meets Class 2 standards (IEC 61672-2013 and ANSI/ASA S1.4/Part 1)	

Typical A-Weighted Sound Levels

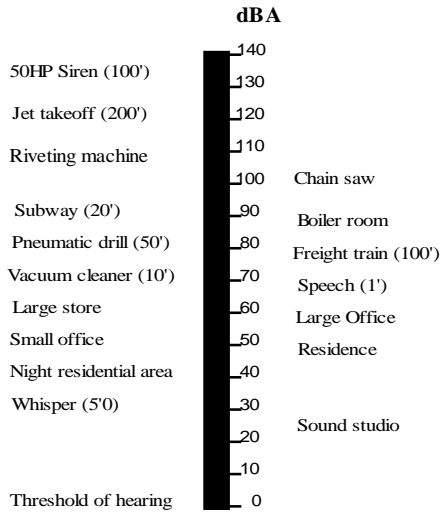

Copyright © 2017 FLIR Systems, Inc.

All rights reserved including the right of reproduction in whole or in part in any form

ISO-9001 Certified

www.extech.com