

TEKNEKA

USER MANUAL

550 Sound Level Meter



Please read this manual before switching the unit on.
Important safety information inside.

Content	Page
1.Product Introduction.....	4
2.Safety Information.....	4
2-1.Environment Conditions.....	4
2-2.Maintenance & Clearing.....	4
2-3.Safety Symbols.....	4
3.Functions Description.....	4
4.Specification.....	5
5.Description.....	6
5-1.Meter Description.....	6
5-2.Symbols Used on LCD Display.....	7
6.Button & Functions.....	8
6-1.Backlight Button.....	8
6-2.MAX/MIN Button.....	8
6-3.REC Button.....	8
6-3-1.Datalogger Function.....	8
6-3-2.Adjusting Datalogger Response.....	8
6-3-3.Data Zero Function.....	9
6-4.HOLD Button.....	9
6-5.Frequency Weighting Select Button.....	9
6-6.FAST/SLOW Button.....	9
6-7.SETUP/Bluetooth Button.....	9
6-7-1.The Time Chip Adjustment and Bluetooth Switch.....	9
6-7-2.USB Communications Setting.....	12
6-7-3.Bluetooth Communications Setting.....	12
6-8.LEVEL Button.....	12
6-9.Power Button.....	12
6-10.External DC 9V Power Supply Terminal.....	12
6-11.USB Interface.....	12
6-12.AC/DC Signal Output Earphone Outlet.....	12
6-13.Calibration Potentiometer (CALL).....	12
7.Calibration Procedures.....	13
8.Measurement Preparation.....	14
9.Operating Procedure.....	14
10.Notice.....	14
11.Accessories.....	14
12.Installing the Software.....	15
13.Mobile APP Software.....	16
14.APP Download.....	18

1. Product Introduction

- This Sound Level Meter is designed for noise project; quality control; illness prevention and cure and all kinds of environmental sounds measurement.
- It is applied to the sounds measurement at factory, school, office, traffic access and household, etc.

2. Safety Information

- Read the following safety information carefully before attempting to operate or service the meter.
- Use the meter only as specified in this manual:

2-1.Environment Conditions

- Altitude lower than 2000 meters
- Relatively humidity <90%RH
- Operation Ambient 0 to 40°C

2-2.Maintenance & Clearing

- Repair or servicing not covered in this manual should be performed by qualified personnel.
- Periodically wipe the case with a dry cloth.
- Do not use solvents or eradicator on this instrumen.

2-3.Safety Symbols

 Comply with EMC

3.Functions Description

- This unit confirms to the IEC61672-1 CLASS2 for Sound Level Meters.
- MAX & MIN measurements.
- Over range display.
- Under range display.
- A & C Weighting.
- FAST & SLOW response.
- Analog AC/DC outputs for connection to frequency analyzer or X-Y shaft recorder.

4. Specification

Standard Applied	IEC61672 -1 CLASS2
Accuracy	±1.4dB
Frequency Range	31.5Hz to 8kHz
Dynamic Range	50dB
Level Ranges	Lo: 30dB to 80dB / Med: 50dB to 100dB / Hi: 80dB to 130dB / Auto: 30dB to 130dB
Frequency Weighting	A/C
Time Weighting	FAST (125ms); SLOW (1s)
Microphone	1/2 inch electret condenser microphone
Display	4 digits LCD display with a resolution of 0.1dB
Display Update	2 times/sec.
Max Hold	Hold the Maximum reading
Min Hold	Hold the Minimum reading
Hold	Hold the readings
Alarm Function	“OVER” is when input is more than upper limit of range; “UNDER” is when input is less than lower limit of range.
Analog Output	AC/DC outputs from earphone outlet, AC=1Vrms; DC=10mV/dB
Data Output	USB data traffic, Bluetooth
Auto Power Off	Meter automatically shuts down after approx. 15 minutes of inactivity.
Power Supply	One 9V battery, 006P or NEDA1604 or IEC 6F22.
Operation Temperature	0 to 40°C
Operation Humidity	10%RH to 90%RH
Storage Temperature	-10 to 60°C
Storage Humidity	10%RH to 75%RH
Dimension (L x W x H)	278 x 76 x 50mm
Weight	350g

5. Description

5-1. Meter Description

- 1-Windscreen
- 2-LCD Display
- 3-Backlight Button
- 4-MAX/MIN Button
- 5-REC Button
- 6-HOLD Button
- 7-Frequency Weighting Select Button
- 8-FAST/SLOW Button
- 9-SETUP/Bluetooth Button
- 10-LEVEL Button
- 11-Power Button
- 12-Microphone
- 13-External DC 9V Power Supply Terminal
- 14-USB Interface
- 15-AC/DC Signal Output Earphone Outlet
- 16-Calibration Potentiometer
- 17-Tripod Mounting Screw
- 18-Battery Cover

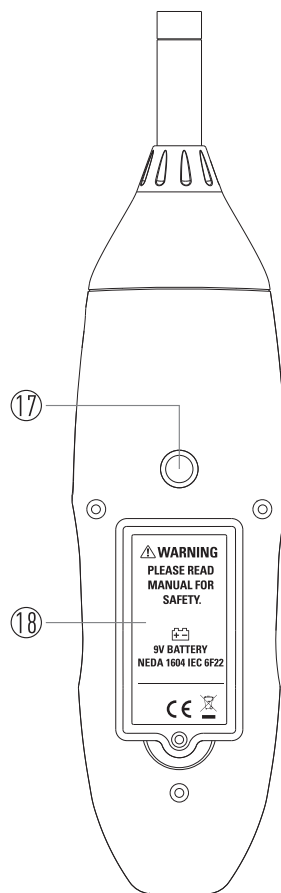
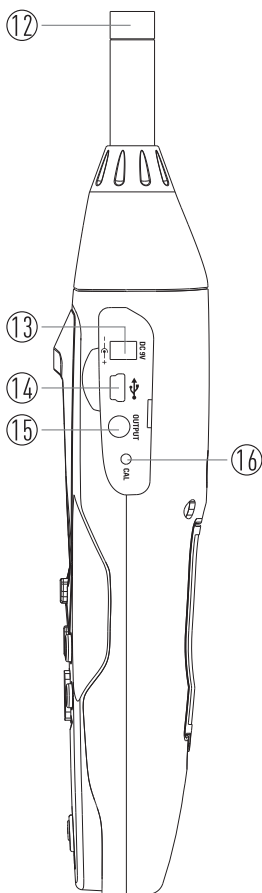
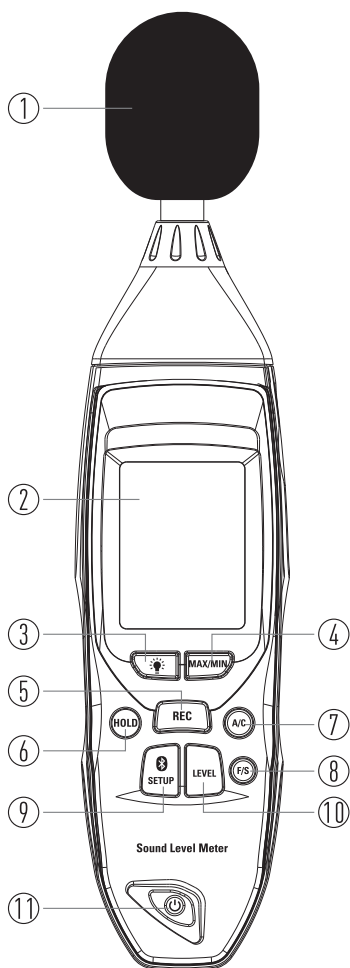

5-2.Symbols Used on LCD Display

1-Under Range	10-4 Digits
2-Maximum Hold	11-Auto power off
3-Bluetooth	12-Low Battery Indicate
4-Minimum Hold	13-Recording Data Into Computer
5-Fast Response	14-Memory Full
6-Slow Response	15-C-Weighting (Response to machine monitor)
7-Over Range	16-A-Weighting (Response to human sense)
8-Range Indicate	17-Data Hold Function
9-Date/Time Indicate	18-Auto Level Range Selection

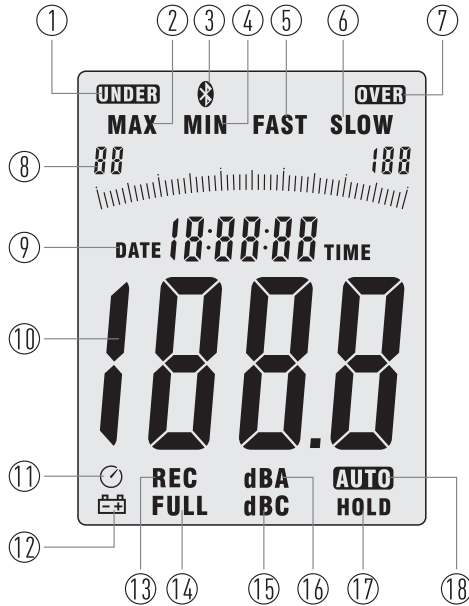

6.Button & Functions

6-1.Backlight Button

- Turn the backlight On/Off.
- Datalogger Response setting:
 - 1.Press the **Backlight** Button continuously until “**Int**” symbol appears after the meter turn on.
 - 2.Press the **LEVEL** Button to set up the data memory response.
 - 3.Then press the **HOLD** Button to keep the setting.



6-2.MAX/MIN Button

- Maximum and Minimum hold Press the **MAX/MIN** Button for one time to enter MAX/MIN measurement, “**MAX**” will appear on LCD, maximum sound level will be captured and held until higher sound level is captured.
- Press the **MAX/MIN** Button again, “**MIN**” will appear on LCD and minimum sound level will be captured and held until new lower sound level is captured.
- Press the **MAX/MIN** Button one more time to exit MAX/MIN measurement.

6-3.REC Button

6-3-1.Datalogger Function

- Press the **REC** Button after it power on, the display will show “**REC**” to start Data Recording.
- Press the **REC** Button again to exit the record.

Note: In order to avoid data error, please don't power it off under REC condition, when the REC function is deleted then it can power off.

6-3-2.Adjusting Datalogger Response

- Press the **Backlight** Button continuously before power it on, then press the **Power** Button, it will be displayed as following.
- Press the **LEVEL** Button to adjust memory time, press the **HOLD** Button to hold the setup.

6-3-3.Data Zero Function

Press the **REC** Button continuously before power it on, loosen the button when the display showing “**CLR**” after the meter power on, which indicates that the data in Datalogger has been deleted.



6-4.HOLD Button

Press the **HOLD** Button, the hold function freezes the reading in the display.

6-5.Frequency Weighting Select Button

- A: A-Weighting
- C: C-Weighting

6-6.FAST/SLOW Button

Time weighting selection.

FAST: St sampling measurement, 1 time per 125ms.

SLOW: Slow sampling measurement, 1 time per second.

6-7.SETUP/Bluetooth Button

6-7-1.The Time Chip Adjustment and Bluetooth Switch

- 1.Press the **SETUP** Button and then power it on, when “**TIME**” symbol displays then loosen the **SETUP** Button, the meter will be under time adjustment mode, at the time the display will show the date as following.



2. Press the **SETUP** Button second time, the display showing; the display showing "minute" adjustment mode, press the **LEVEL** Button to make the adjustment, press the **HOLD** Button to keep the setup.

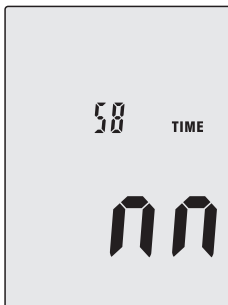

3. Press the **SETUP** Button third time, the display showing; the display showing "hour" adjustment mode (h-P=P.M, h-A=A.M), press the **LEVEL** Button to make the adjustment, press the **HOLD** Button to keep the setup.

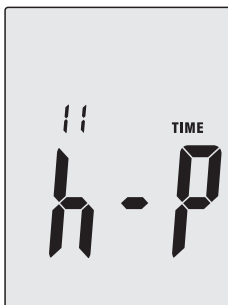

4. Press the **SETUP** Button fourth time, the display showing; the display showing "date" adjustment mode, press the **LEVEL** Button to make the adjustment, press the **HOLD** Button to keep the setup.



5. Press the **SETUP** Button fifth time, the display showing; the display showing "month" adjustment mode, press the **LEVEL** Button to make the adjustment, press the **HOLD** Button to keep the setup.

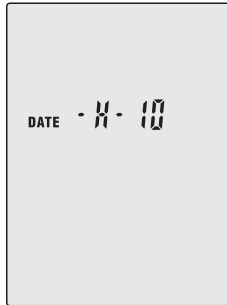

6. Press the **SETUP** Button sixth time, the display showing; the display showing "year" adjustment mode, press the **LEVEL** Button to make the adjustment, press the **HOLD** Button to keep the setup.

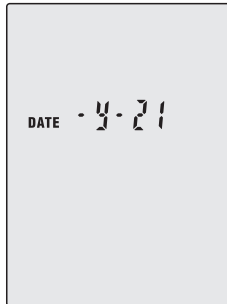

7. Press the **SETUP** Button seventh time, the display showing; the display showing initialization of the time chip, press the **HOLD** Button to keep the setup; time and date have returned to factory setup; when the battery is exhausted or replaced, if the time can't be adjusted then please initialize the time chip first.



6-7-2.USB Communications Setting

- Turn on the meter, connect the meter with the computer correctly, choose the software COM3 (COM4).
- Then press the **SETUP** Button, "🕒" disappears from the display to indicate and disable auto power off, that the USB data is transmitting.

6-7-3.Bluetooth Communications Setting

When you press the **SETUP** Button or **REC** Button, "🕒" disappears from the display to indicate and disable auto power off, that the Bluetooth data is transmitting.

6-8.LEVEL Button: Level Range Selection

Each time you press the **LEVEL** Button, the level range will change between "Lo" level, "Med" level, "Hi" level and "Auto" level in the circular.

6-9.Power Button

Turn the meter power ON/OFF.

6-10.External DC 9V Power Supply Terminal

- For connection with DC 9V power supply.
- Aperture size: External diameter: 3.5mm; Internal diameter: 1.35mm.

6-11.USB Interface

USB signal output is a 9600 bps serial interface.

6-12.AC/DC Signal Output Earphone Outlet

AC Output Voltage: 1Vrms corresponding to each range step

AC Output Impedance: 100 Ω

DC Output Voltage: 10mV/dB

DC Output Impedance: 1k Ω

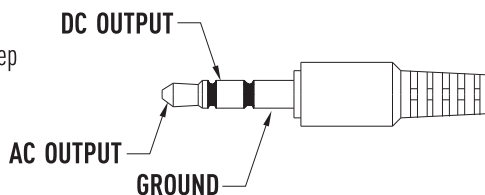

6-13.Calibration Potentiometer (CALL)

For external standard level calibration adjustments.

7. Calibration Procedures

1. Make the following switch settings:

- Frequency Weighting: A-Weighting
- Time Weighting: FAST
- Level Range: 50 to 100dB

2. Insert the microphone housing carefully into the 1/2 inch insertion hole of the calibrator (94dB at 1kHz).

3. Turn on the switch of calibrator and adjust the CALL potentiometer of the unit 94.0dB is displayed.

Note: All products are well calibrated before shipment. Recommended recalibration cycle 1 year.

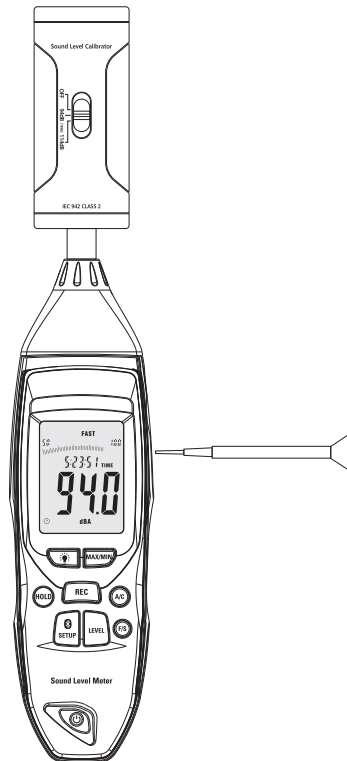

8.Measurement Preparation

- 1.Remove the battery cover on the back and put in one 9V battery.
- 2.Recover the back cover.
- 3.When battery voltage drops below the operating voltage or battery aging, this symbol “” will appear on LCD, replace the 9V battery.
- 4.When the AC adapter is used, insert the plug of the adapter (3.5Ø) into the DC 9V connector on the side panel.

9.Operating Procedure

- 1.Power on the meter.
- 2.Press the **LEVEL** Button to select desired level, base on “**UNDER**” or “**OVER**” do not appear on LCD.
- 3.Select “**dB**A” for general noise sound level and “**dB**C” or measuring sound level of acoustic material.
- 4.Select “**FAST**” for instant sound and “**SLOW**” for average sound level.
- 5.Select the **MAX/MIN** Button for measuring maximum and minimum noise level.
- 6.Hold the instrument comfortable in hand or fix on tripod and measure sound level at a distance of 1–1.5 meter.

10.Notice

- Do not store or operate the instrument at high temperature and high humidity environment.
- When not in use for long time, please take out the battery to avoid battery liquid leakage and cautery on the instrument.
- When using the instrument in the presence of wind, it is a must to mount the windscreen to not pick up undesirable signals.
- Keep microphone dry and avoid severe vibration.

11.Accessories

- Instruction Manual
- Installation CD
- Screwdriver
- Tripod Mounting
- Battery
- Power Source
- 3.5Ø Earphone Plug
- Windscreen
- Software
- USB Interface Cable

12. Installing the Software

1. Start Windows.
2. Insert the CD into the CD-drive.
3. Run "**SETUP.exe**" installation program in file DISK1, install it to the referred directory
4. Install **CP210X** drive software, connecting the meter with the computer by USB interface, install **CP2102** drive software in "My computer property:\hardware\facility management\ COM CP210X USB".
5. USB Drive Installation.
 - Copy the **CP210XWIN** Drivers to a certain directory, such as "C:\usb_driver".
 - Connect the USB to the computer, the Windows system will show finding a new hardware, choose specific directory "C:\usb_driver" according to the instruction.
 - After Driver installation, a new COM port will be added to the Ports in the Device Manager, port number will be ranged following the primary COM ports, such as "COM3 or COM4".
6. Once the drive software is installed, start the application software, connect the meter to the computer by USB, then search for the COMX port occupied by CP210X, press the **SETUP** Button, the "🕒" symbol will not appear on the display, which indicate the meter is transmitting data to the computer.

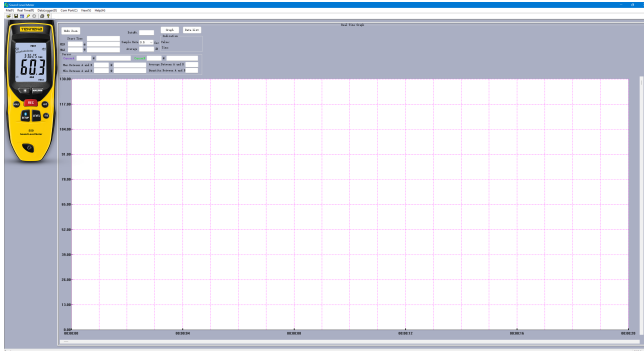

7. More information please refer to the software help document.

13.Mobile APP Software

1.Start APP

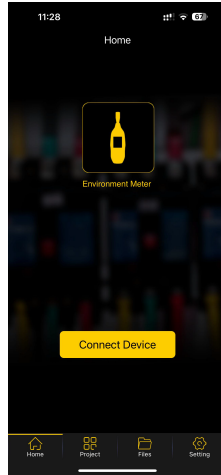

2.Click “**Connect Device**” to search for Bluetooth devices, and click Corresponding Equipment.

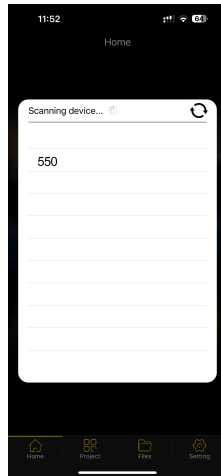

3. Select **"Environment Meter"** to enter the instrument display interface.



4. View real-time display noise data and select control instructions.



5. More information please refer to the software help document.

14.APP Download

- Download **TEKNEKA** APP to connect with the meter to get more function.
- Search the APP name **TEKNEKA** at App Store (for iOS) or Google play (for android) or scan the QR code to download the APP.



Copyright © 2023 Tekneka, Canada.

All rights reserved including the right of reproduction in whole or in part in any form

info@tekneka.com

www.tekneka.com

