



RIGOL

# DHO800 Series

Digital Oscilloscope

Quick Guide

Jan. 2024

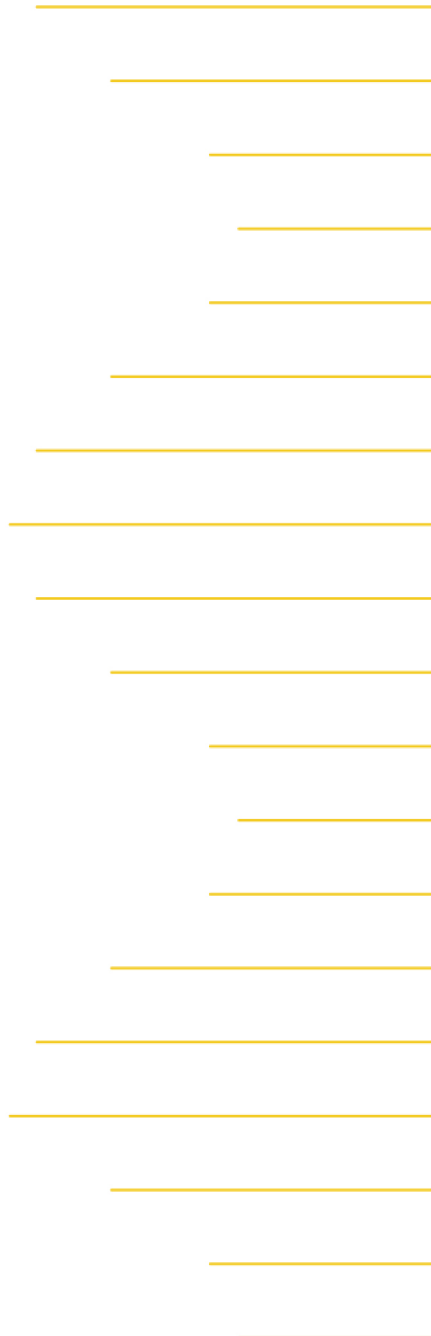

## **Guaranty and Declaration**

### **Copyright**

© 2024 RIGOL TECHNOLOGIES CO., LTD. All Rights Reserved.

### **Trademark Information**

RIGOL® is the trademark of RIGOL TECHNOLOGIES CO., LTD.

### **Software Version**

Software upgrade might change or add product features. Please acquire the latest software version from **RIGOL** website or contact **RIGOL** to upgrade the software.

### **Notices**

- RIGOL products are covered by P.R.C. and foreign patents, issued and pending.
- RIGOL reserves the right to modify or change parts of or all the specifications and pricing policies at the company's sole decision.
- Information in this publication replaces all previously released materials.
- Information in this publication is subject to change without notice.
- RIGOL shall not be liable for either incidental or consequential losses in connection with the furnishing, use, or performance of this manual, as well as any information contained.
- Any part of this document is forbidden to be copied, photocopied, or rearranged without prior written approval of RIGOL.

### **Product Certification**

RIGOL guarantees that this product conforms to the national and industrial standards in China as well as the ISO9001:2015 standard and the ISO14001:2015 standard. Other international standard conformance certifications are in progress.

### **Contact Us**

If you have any problem or requirement when using our products or this manual, please contact RIGOL.

E-mail: [service@rigol.com](mailto:service@rigol.com)

Website: <http://www.rigol.com>

# 1 Safety Requirement

## 1.1 General Safety Summary

Please review the following safety precautions carefully before putting the instrument into operation so as to avoid any personal injury or damage to the instrument and any product connected to it. To prevent potential hazards, please follow the instructions specified in this manual to use the instrument properly.

- |   |  |    |  |
|---|--|----|--|
| 1 | Only the exclusive power cord designed for the instrument and authorized for use within the destination country could be used. | 8  | Do not operate the instrument with suspected failures. |
| 2 | Ensure that the instrument is safely grounded.   | 9  | Provide adequate ventilation.                          |
| 3 | Observe all terminal ratings.  | 10 | Do not operate in wet conditions.                      |
| 4 | Use proper overvoltage protection.   | 11 | Do not operate in an explosive atmosphere.             |
| 5 | Do not operate without covers.   | 12 | Keep instrument surfaces clean and dry.                |
| 6 | Do not insert objects into the air outlet.   | 13 | Prevent electrostatic impact.                          |
| 7 | Avoid circuit or wire exposure.  | 14 | Handle with caution.                                   |



### WARNING

Equipment meeting Class A requirements may not offer adequate protection to broadcast services within residential environment.

## 1.2 Safety Notices and Symbols

Safety Notices in this Manual:



### WARNING

Indicates a potentially hazardous situation or practice which, if not avoided, will result in serious injury or death.



### CAUTION

Indicates a potentially hazardous situation or practice which, if not avoided, could result in damage to the product or loss of important data.

**Safety Notices on the Product:**

- **DANGER**  
It calls attention to an operation, if not correctly performed, could result in injury or hazard immediately.
- **WARNING**  
It calls attention to an operation, if not correctly performed, could result in potential injury or hazard.
- **CAUTION**  
It calls attention to an operation, if not correctly performed, could result in damage to the product or other devices connected to the product.

**Safety Symbols on the Product:**

**Hazardous Voltage**



**Safety Warning**



**Protective Earth Terminal**

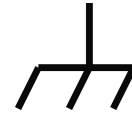

**Chassis Ground**



**Test Ground**

## 1.3 Measurement Category

**Measurement Category**

This instrument can make measurements in Measurement Category I.

**WARNING**

**This instrument can only be used for measurements within its specified measurement categories.**

**Measurement Category Definitions**

- **Measurement category I** is for measurements performed on circuits not directly connected to MAINS. Examples are measurements on circuits not derived from MAINS, and specially protected (internal) MAINS derived circuits. In the latter case, transient stresses are variable. Thus, you must know the transient withstand capability of the equipment.
- **Measurement category II** is for measurements performed on circuits directly connected to low voltage installation. Examples are measurements on household appliances, portable tools and similar equipment.
- **Measurement category III** is for measurements performed in the building installation. Examples are measurements on distribution boards, circuit-breakers, wiring (including cables, bus-bars, junction boxes, switches and socket-outlets) in the fixed installation, and equipment for industrial use and some other

equipment. For example, stationary motors with permanent connection to a fixed installation.

- **Measurement category IV** is for measurements performed at the source of a low-voltage installation. Examples are electricity meters and measurements on primary overcurrent protection devices and ripple control units.

## 1.4 Ventilation Requirement

This instrument uses a fan to force cooling. Please make sure that the air inlet and outlet areas are free from obstructions and have free air. When using the instrument in a bench-top or rack setting, provide at least 10 cm clearance beside, above and behind the instrument for adequate ventilation.



### CAUTION

Inadequate ventilation may cause an increase of temperature in the instrument, which would cause damage to the instrument. So please keep the instrument well ventilated and inspect the air outlet and the fan regularly.

## 1.5 Working Environment

### Temperature

Operating: 0°C to +50°C

Non-operating: -30°C to +60°C

### Humidity

- **Operating:**
  - Below +30°C:  $\leq 90\%RH$  (without condensation)
  - +30°C to +40°C:  $\leq 75\% RH$  (without condensation)
  - +40°C to +50°C:  $\leq 45\%RH$  (without condensation)
- **Non-operating:**
  - Below +60°C:  $\leq 90\%RH$  (without condensation)



### WARNING

To avoid short circuit inside the instrument or electric shock, never operate the instrument in a humid environment.

### Altitude

- **Operating:** below 3 km
- **Non-operating:** below 15 km

### Protection Level Against Electric Shock

ESD  $\pm 8\text{kV}$

### Installation (Overvoltage) Category

This product is powered by mains conforming to installation (overvoltage) category II.



#### WARNING

Ensure that no overvoltage (such as that caused by a bolt of lightning) can reach the product. Otherwise, the operator might be exposed to the danger of an electric shock.

### Installation (Overvoltage) Category Definitions

Installation (overvoltage) category I refers to signal level which is applicable to equipment measurement terminals connected to the source circuit. Among these terminals, precautions are done to limit the transient voltage to a low level.

Installation (overvoltage) category II refers to the local power distribution level which is applicable to equipment connected to the AC line (AC power).

### Pollution Degree

Pollution Degree 2

#### Pollution Degree Definition

- **Pollution Degree 1:** No pollution or only dry, nonconductive pollution occurs. The pollution has no effect. For example, a clean room or air-conditioned office environment.
- **Pollution Degree 2:** Normally only nonconductive pollution occurs. Temporary conductivity caused by condensation is to be expected. For example, indoor environment.
- **Pollution Degree 3:** Conductive pollution or dry nonconductive pollution that becomes conductive due to condensation occurs. To be found in industrial environment or construction sites (harsh environments). For example, sheltered outdoor environment.
- **Pollution Degree 4:** The pollution generates persistent conductivity caused by conductive dust, rain, or snow. For example, outdoor areas.

### Safety Class

Class 2

## 1.6 Care and Cleaning

### Care

Do not store or leave the instrument where it may be exposed to direct sunlight for long periods of time.

## Cleaning

Clean the instrument regularly according to its operating conditions.

1. Disconnect the instrument from all power sources.
2. Clean the external surfaces of the instrument with a soft cloth dampened with mild detergent or water. Avoid having any water or other objects into the chassis via the heat dissipation hole. When cleaning the LCD, take care to avoid scarifying it.



### CAUTION

To avoid damage to the instrument, do not expose it to caustic liquids.



### WARNING

To avoid short-circuit resulting from moisture or personal injuries, ensure that the instrument is completely dry before connecting it to the power supply.

## 1.7 Environmental Considerations

The following symbol indicates that this product complies with the WEEE Directive 2002/96/EC.



The equipment may contain substances that could be harmful to the environment or human health. To avoid the release of such substances into the environment and avoid harm to human health, we recommend you to recycle this product appropriately to ensure that most materials are reused or recycled properly. Please contact your local authorities for disposal or recycling information.

You can click on the following link <https://int.rigol.com/services/services/declaration> to download the latest version of the RoHS&WEEE certification file.

## 2 Document Overview

This manual gives you a quick overview of the front and rear panel, user interface as well as basic operation methods of DHO800 series.



### TIP

For the latest version of this manual, download it from RIGOL official website (<http://www.rigol.com>).

### Publication Number

QGA36102-1110

### Software Version

Software upgrade might change or add product features. Please acquire the latest version of the manual from RIGOL website or contact RIGOL to upgrade the software.

### Format Conventions in this Manual

#### 1. Key

The front panel key is denoted by the menu key icon. For example,  indicates the "Default" key.

#### 2. Menu

The menu item is denoted by the format of "Menu Name (Bold) + Character Shading" in the manual. For example, **Setup** indicates the "Setup" sub-menu under the "Utility" function menu. You can click or tap **Setup** to access the "Setup" menu.

#### 3. Operation Procedures

The next step of the operation is denoted by ">" in the manual. For example, 

> **Storage** indicates first clicking or tapping  and then clicking or tapping **Storage**.

#### 4. Connector

The front/rear panel connector is denoted by "Brackets + Connector Name (Bold)", for example, **[AUX OUT]**.

### Content Conventions in this Manual

DHO800 series digital oscilloscope includes the following models. Four-channel models and two-channel models share the same operation method. Unless otherwise specified, this manual takes the four-channel model DHO814 as an example to illustrate the operation methods of DHO800 series oscilloscope.



---

<b>Model</b>	<b>Max. Analog Bandwidth</b>	<b>No. of Analog Channels</b>
DHO802	70 MHz	2+EXT
DHO804	70 MHz	4
DHO812	100 MHz	2+EXT
DHO814	100 MHz	4

## 3 General Inspection

---

### 1. Inspect the packaging

If the packaging has been damaged, do not dispose the damaged packaging or cushioning materials until the shipment has been checked for completeness and has passed both electrical and mechanical tests.

The consigner or carrier shall be liable for the damage to the instrument resulting from shipment. RIGOL would not be responsible for free maintenance/rework or replacement of the instrument.

### 2. Inspect the instrument

In case of any mechanical damage, missing parts, or failure in passing the electrical and mechanical tests, contact your RIGOL sales representative.

### 3. Check the accessories

Please check the accessories according to the packing lists. If the accessories are damaged or incomplete, please contact your RIGOL sales representative.

### Recommended Calibration Interval

RIGOL suggests that the instrument should be calibrated every 18 months.

## 4 Product Overview

RIGOL introduces the brand new DHO800 series economy oscilloscope into its oscilloscope family. With a compact size, the DHO800 series achieves a waveform capture rate of 1,000,000 wfms/s with the UltraAcquire mode, 25 Mpts memory depth, 12 bits resolution, and low noise.

### 4.1 Appearance and Dimensions

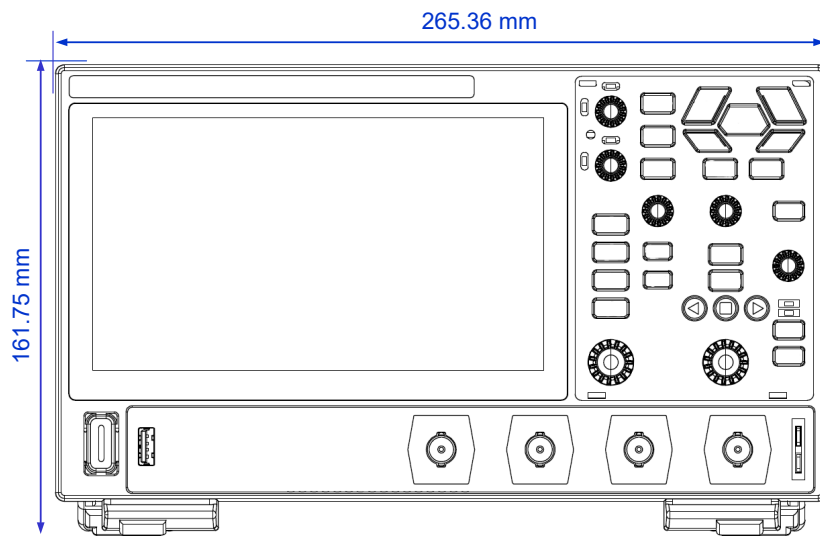

Figure 4.1 Front View

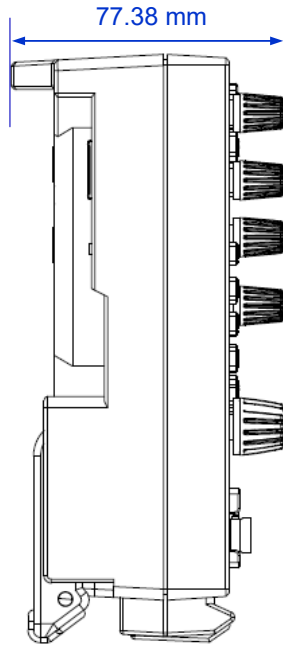

Figure 4.2 Side View

## 4.2 Front Panel Overview

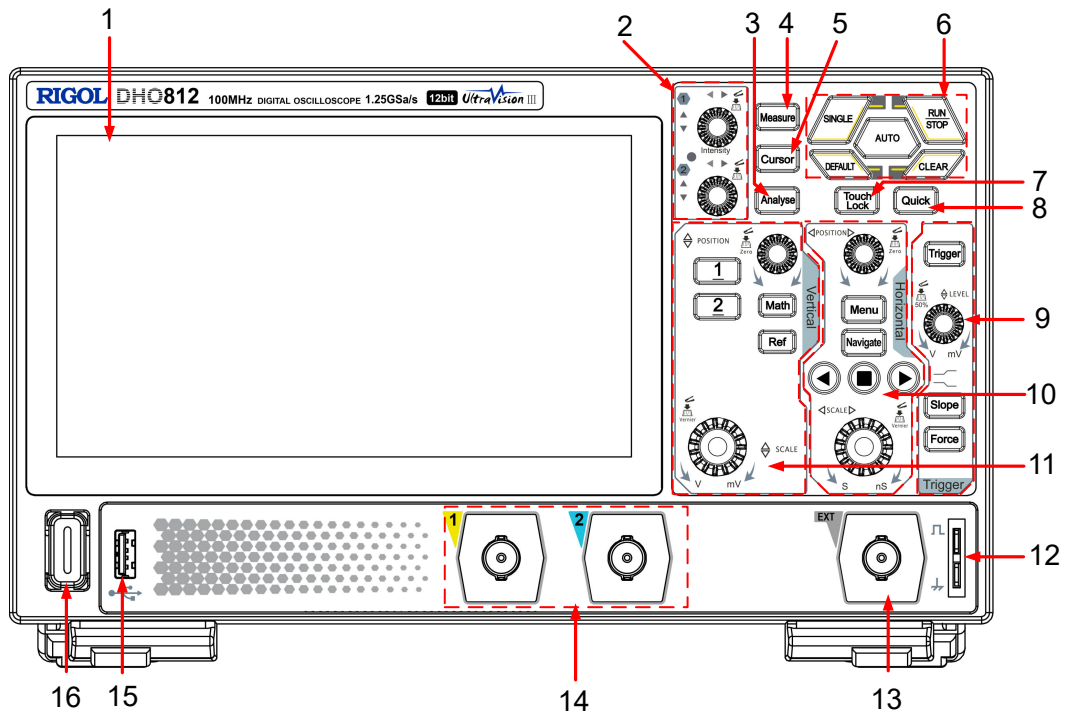
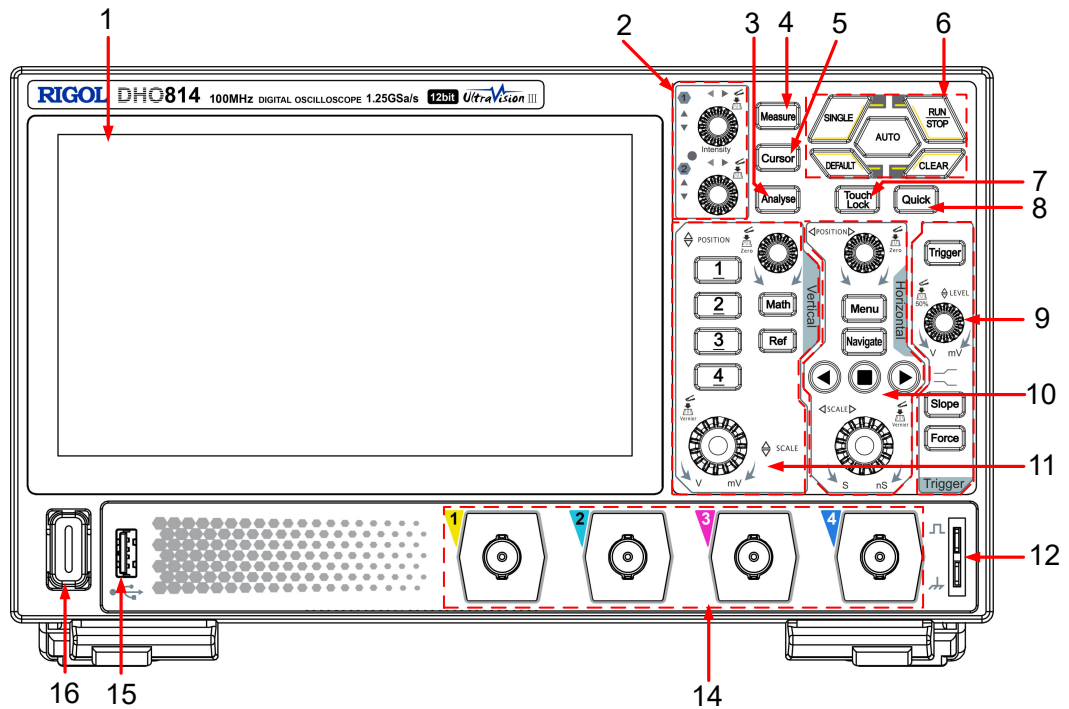

Figure 4.3 Front Panel (2-channel Model)



**Figure 4.4 Front Panel (4-channel Model)**

1	7" Capacitive Touch Screen	9	Trigger Controls
2	Multipurpose Knobs	10	Horizontal Controls
3	Analyse Key	11	Vertical Controls
4	Measure Key	12	Probe Compensation Signal Output Terminal/Ground Terminal
5	Cursor Key	13	External Trigger Input Terminal (for two-channel models only)
6	Common Tools Keys	14	Analog Channel Input Terminals
7	Touch Lock Key	15	USB HOST Port
8	Quick Action Key (Self-defined function)	16	Power Key

## 4.3 Rear Panel Overview

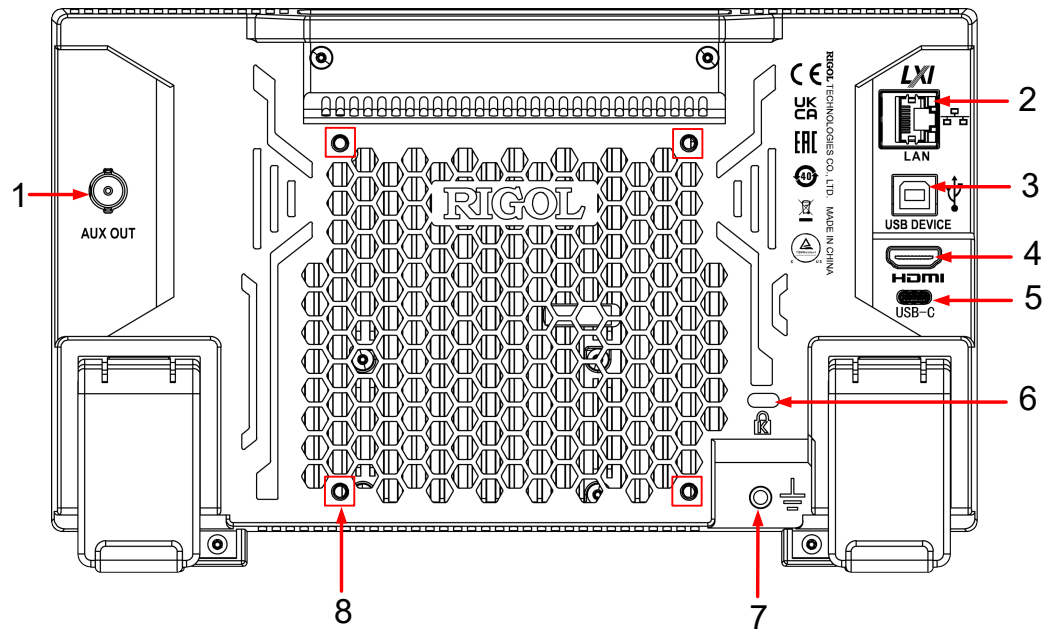

Figure 4.5 Rear Panel

- 1 AUX OUT Interface
- 2 LAN Port
- 3 USB DEVICE Port
- 4 HDMI Connector
- 5 USB Type-C Power Connector
- 6 Security Lock Hole
- 7 Ground Terminal
- 8 Mounting Screws (VESA 100 x 100)

## 4.4 User Interface Overview

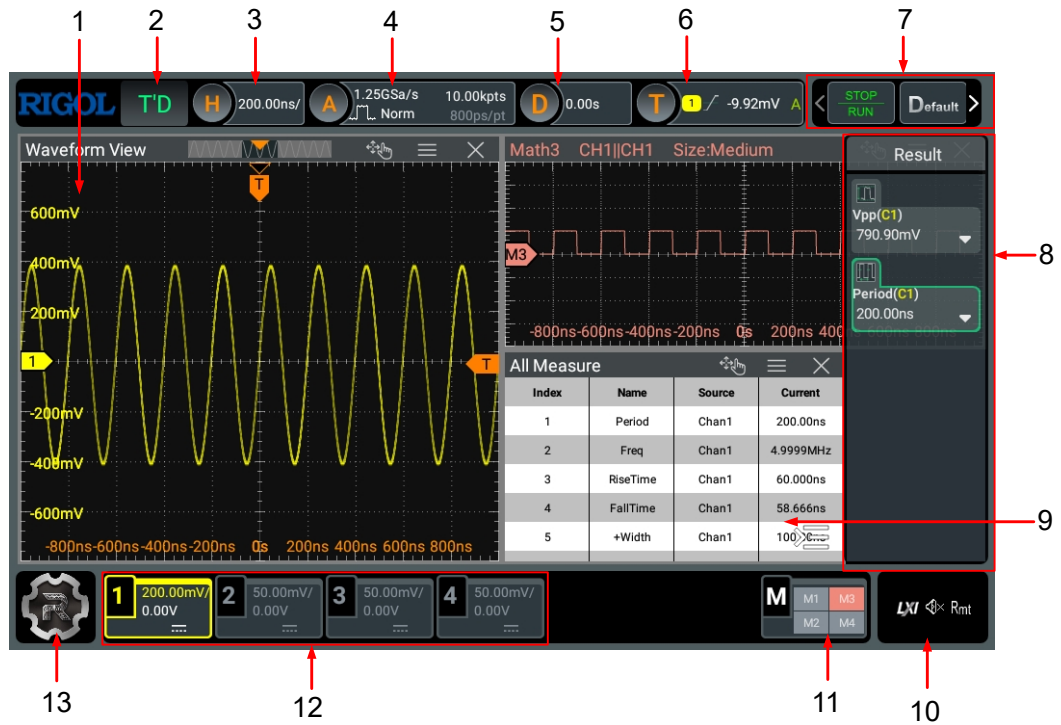

Figure 4.6 User Interface

1	Waveform View	8	Result Sidebar
2	Run State Label	9	Split-screen Display
3	Horizontal Timebase Label	10	Notification Area
4	Sample Rate & Memory Depth Label	11	Math Labels
5	Horizontal Position Label	12	Channel Labels
6	Trigger Label	13	Function Navigation Icon
7	Function Toolbar		

## 5 To Prepare for Use

### 5.1 To Adjust the Supporting Legs

Adjust the supporting legs properly to use them as stands to tilt the oscilloscope upwards for stable placement of the oscilloscope as well as better operation and observation. You can also fold the supporting legs when the instrument is not in use for easier storage or shipment, as shown in the figure below.

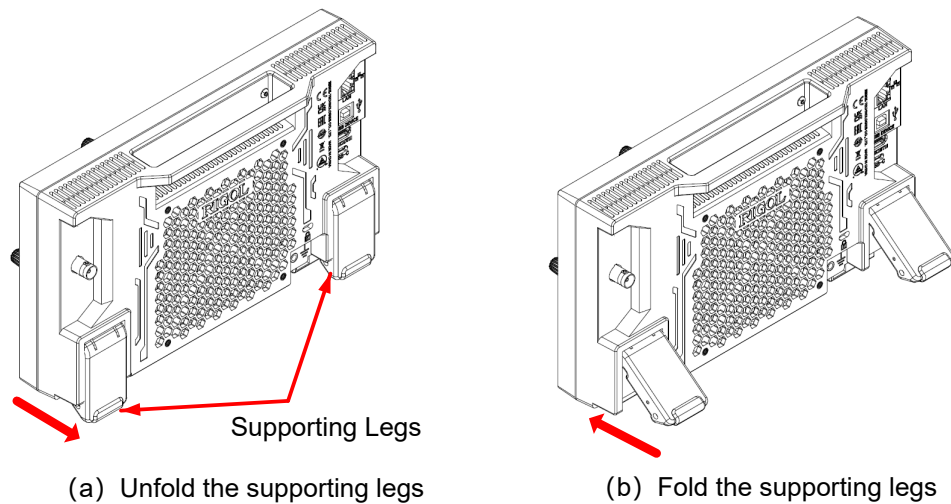

Figure 5.1 Adjusting the Supporting Legs

### 5.2 To Connect to Power

The power requirements of the oscilloscope are DC, 12 V, 4 A. Please use the power adaptor provided in the accessories to connect the oscilloscope to the AC power source (100 V to 240 V, 50 Hz to 60 Hz), as shown in the figure below.



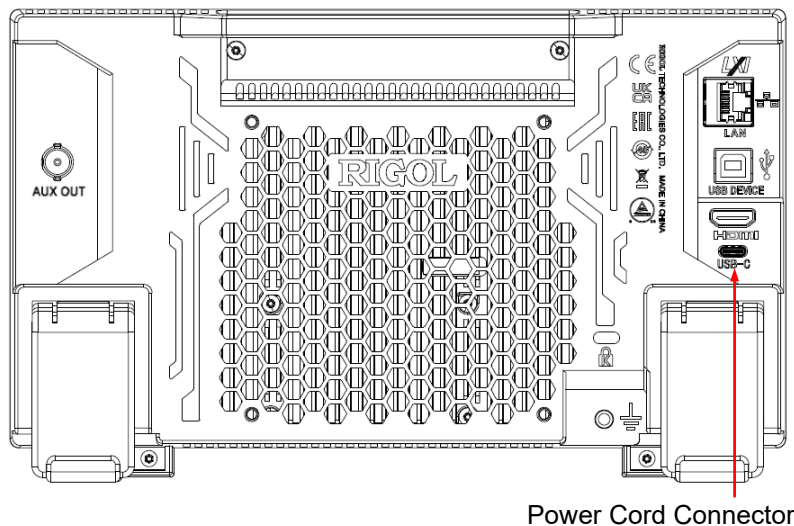

Figure 5.2 To Connect to Power

Table 5.1 Power Adaptor Specifications

Item	Description
Input	100 V to 240 V, 50 Hz to 60 Hz, 1.2 A Max
Output	DC, 12 V, 4 A, 48 W

**CAUTION**

The power adaptor provided in accessories can only be used to power RIGOL instruments. Do not use it for mobile phone and other devices.

**WARNING**





To avoid electric shock, ensure that the instrument is correctly grounded.

## 5.3 Turn-on Checkout

After the instrument is connected to the power source, press the power key  at the lower-left corner of the front panel to power on the instrument. During the start-up process, the instrument performs a series of self-tests. After the self-test, the splash screen is displayed.

- **Restart:** Click or tap  > **Restart**. Then a prompt message "Are you sure to reboot?" is displayed. Click or tap **OK** to restart the instrument.

- **Shutdown:**

- Click or tap  > **Shutdown**. Then a prompt message "Are you sure to shutdown?" is displayed. Click or tap **OK** to shut down the instrument.
- Press  and a prompt message "Are you sure to shutdown?" is displayed. Click or tap **OK** to shut down the instrument.
- Press  twice to shut down the instrument.
- Press  for three seconds to shut down the instrument.

**TIP**

You can also click or tap  > **Utility** > **Setup** and set the "Power status" to "Switch on". The instrument powers on once connected to power.

## 5.4 To Set the System Language

This oscilloscope supports multiple languages. You can click or tap  > **Utility** > **Setup** > **Language** to select the system language.

## 5.5 To Connect the Probe

RIGOL provides passive probes for DHO800 series. For specific probe models, refer to *DHO800 Data Sheet*. For detailed technical information of the probes, please refer to the corresponding Probe User Guide.

### Connect the Passive Probe

1. Connect the BNC terminal of the probe to an analog channel input terminal of the oscilloscope on the front panel as shown in the figure below.
2. Connect the ground alligator clip or spring of the probe to the circuit ground terminal, and then connect the probe tip to the circuit point to be tested.

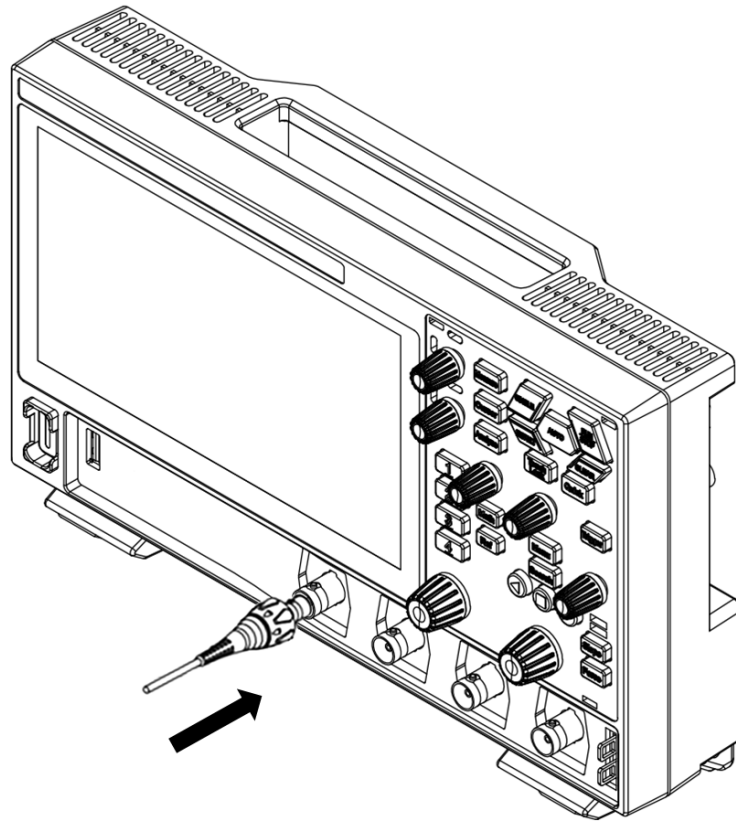

**Figure 5.3 Connecting the Passive Probe**

After you connect the passive probe, check the probe function and probe compensation adjustment before making measurements. For details, please refer to [Function Inspection](#) and [Probe Compensation](#).

## 5.6 Function Inspection

1. Press the front-panel  and a prompt message "Restore default settings?" is displayed. Click or tap **OK** to restore the instrument to its factory default settings.
2. Connect the ground alligator clip of the probe to the "Ground Terminal" as shown in [Figure 5.4](#).
3. Use the probe to connect the input terminal of CH1 and the "Compensation Signal Output Terminal" of the probe, as shown in [Figure 5.4](#).

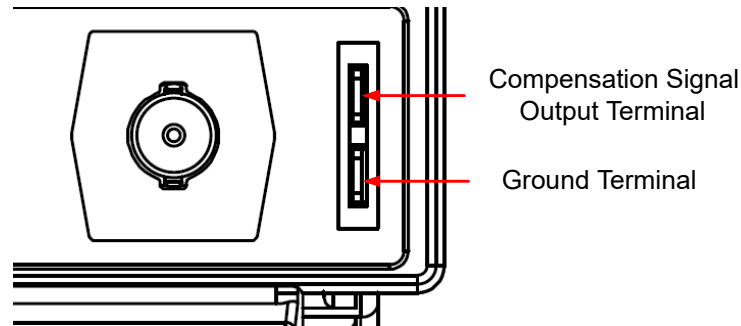

Figure 5.4 Using the Compensation Signal

4. Set the probe ratio based on the attenuation of the probe, and then click or tap



5. Observe the waveform on the display. In normal condition, you should see a square waveform similar to the waveform shown in the figure below.

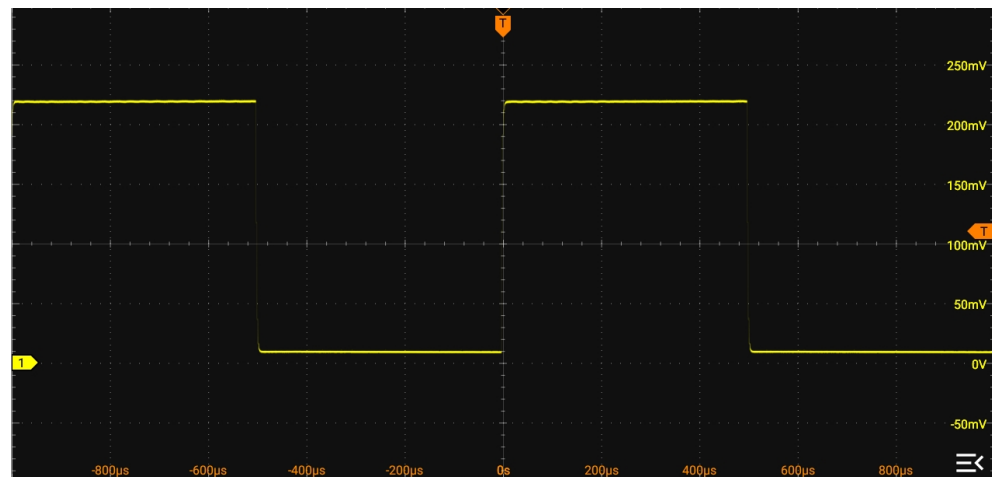

Figure 5.5 Square Waveform Signal

6. Test the other channels in the same way. If you see the waveform, but the square wave is not shaped correctly as shown above, perform the procedure described in *Probe Compensation*. If you do not see the waveform, perform those steps again.



#### WARNING

To avoid electric shock when using the probe, please make sure that the insulated wire of the probe is in good condition. Do not touch the metallic part of the probe when the probe is connected to high voltage source.

## 5.7 Probe Compensation

When used for the first time, the oscilloscope probe must be compensated to match the input characteristics of the oscilloscope channel to which it is connected. The

non-compensated or poorly compensated probe may cause measurement errors. The compensation procedure is as follows:

1. Perform Step 1, 2, 3 and 4 in **Function Inspection**.
2. Check the displayed waveforms and compare them with the waveforms shown in

*Figure 5.6*.

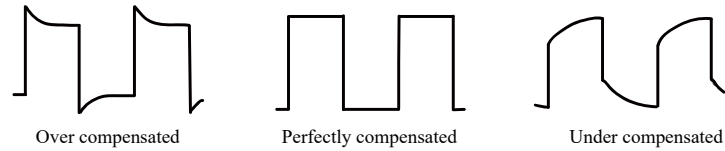

**Figure 5.6 Probe Compensation**

3. Use the probe compensation adjustment tool provided in the accessories to adjust the low-frequency compensation adjustment hole on the probe until the displayed waveform is consistent with the "Perfectly compensated" waveform shown in the above figure.

## 6 Touch Screen Gestures

The instrument's large capacitive touch screen makes operation and configuration easy and flexible. The highly sensitive user interface designed for touch has a strong waveform display capability, bringing an extraordinary user experience. The actions supported by the touch screen controls include tapping, pinching&stretching, as well as dragging.

### 6.1 Tap

Use one finger to tap the symbol or characters on the screen slightly, as shown in *Figure 6.1*. With the Tap gesture, you can perform the following operations:

- Tap the menu displayed on the screen to operate on the menu.
- Tap the function navigation icon at the lower-left corner of the touch screen to enable the function navigation.
- Tap the displayed numeric keypad to set the parameters.
- Tap the virtual keypad to set the label name and the filename.
- Tap the close button at the upper-right corner of the message box to close the prompt window.
- Tap other windows on the touch screen and operate on the windows.



**Figure 6.1 Tap Gesture**

### 6.2 Drag

Use one finger to select the object, and then drag the object to a destination place, as shown in the figure below. With the drag gesture, you can perform the following operation:

- Drag the waveform to change its position or scale.
- Drag the window controls to change the position of the window (e.g. numeric keypad).
- Drag the cursor to move the cursor.
- Drag the trigger cursor to change the trigger level.
- In multi-window display, drag one of the displayed windows to change its position on the display.

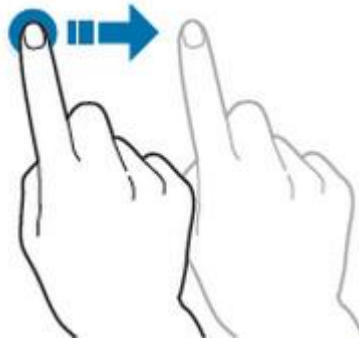

Figure 6.2 Drag Gesture

## 6.3 Pinch&Stretch

Pinch or stretch two points on the screen with two fingers to zoom in or out the waveform. To zoom in the waveform, first pinch the two fingers and then stretch the fingers; to zoom out the waveform, first stretch the two fingers, and then pinch the fingers together, as shown in the figure below. With the pinch&stretch gesture, you can perform the following operation:

- Pinching&stretching in the horizontal direction can adjust the horizontal time base of the waveform.
- Pinching&stretching in the vertical direction can adjust the vertical scale of the waveform.



**Figure 6.3 Pinch&Stretch Gesture**



## 7 To Use the Built-in Help System

---

The built-in help file provides information about the functions and menu

introductions of the instrument. Click or tap  > **Help** to enter the help system.

In the help system, you can get its help information by clicking on or tapping the link for the specified chapter.

## 8 Parameter Setting Method

For this instrument, you can use the knob and touch screen to set parameters. The common parameter setting methods are as follows:

- **Method 1:** Some parameters can be adjusted by rotating the knob on the front panel.
- **Method 2:** Click or tap the input field of a specified parameter, then a virtual keypad is displayed. Complete the parameter setting with the keypad.

### Input a Value

When setting or modifying a parameter, input an appropriate value with the numeric keypad.

- Click or tap the value or unit in the numeric keypad to complete the input.
- Rotate the multipurpose knob (1/2) to move the cursor to select the desired value and unit. Press the knob to confirm the input.

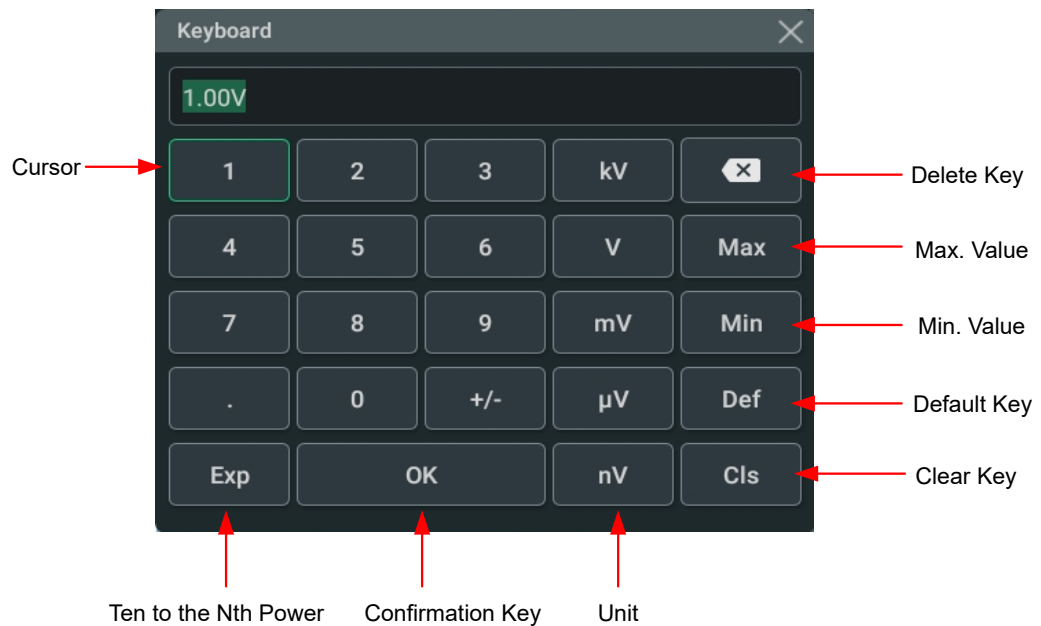

**Figure 8.1 Numeric Keypad**

After you input all the values and select the desired units, the numeric keypad is turned off automatically. This indicates that you have completed parameter setting. Besides, after you have input the values, you can also click or tap "OK" directly to close the numeric keypad. At this time, the unit of the parameter is the default unit. In the numeric keypad, you can perform the following operations:

- Modify the parameter value that has been input;

- 
- Set the parameter value to a maximum or minimum value;
  - Set the parameter to a default value;
  - Clear the parameter input field.

## 9 Remote Control

The following ways of remote control are supported:

- **User-defined Programming**

Users can program and control the instrument by using the SCPI (Standard Commands for Programmable Instruments) commands. For details about the SCPI commands and programming, refer to *Programming Guide* of this product series.

- **PC Software**

Users can use the PC software to send commands to control the instrument remotely. RIGOL Ultra Sigma is recommended. You can download the software from RIGOL official website (<http://www.rigol.com>).

**Operation Procedures:**

- Set up communication between the instrument and PC.
- Run Ultra Sigma and search for the instrument resource.
- Open the remote command control panel to send commands.

- **Web Control**

This instrument supports Web Control. Connect the instrument to the network, then input the IP address of the instrument into the address bar of the browser of your computer. The web control interface is displayed. Click Web Control to enter the web control page. Then you can view the display of the real-time interface of the instrument. Through the Web Control method, you can migrate the device control to the control terminals (e.g. PC, Mobile, iPad, and other smart terminals) to realize remote control of the instrument. When you first log in to the Web Control, the user name is "admin" and password is "rigol".

This instrument can be connected to the PC via the USB and LAN interface to set up communication and realize remote control through the PC. The remote control can be realized by using SCPI (Standard Commands for Programmable Instruments) commands.

**CAUTION**

**Before connecting the communication cable, please turn off the instrument to avoid causing damage to the communication interfaces.**



## 10 More Product Information

---

Click or tap  > **Utility** > **About** to obtain the information of the instrument, such as the model, serial number, and hardware version number.

For more information about the instrument, refer to the relevant manuals by logging in to the official website of RIGOL (<http://www.rigol.com>) to download them.

- *DHO800 User Guide* introduces the functions of the instrument and the operation methods, remote control methods, possible failures and solutions in using the instrument, specifications, and order information.
- *DHO800 Programming Guide* provides detailed descriptions of SCPI commands and programming examples of the instrument.
- *DHO800 Data Sheet* provides the key features and technical specifications of the instrument.

#### HEADQUARTER

**RIGOL TECHNOLOGIES CO., LTD.**  
No.8 Keling Road, New District, Suzhou,  
JiangSu, P.R.China  
Tel: +86-400620002  
Email: info@rigol.com

#### EUROPE

**RIGOL TECHNOLOGIES EU GmbH**  
Carl-Benz-Str.11  
82205 Gilching  
Germany  
Tel: +49(0)8105-27292-0  
Email: info-europe@rigol.com

#### NORTH AMERICA

**RIGOL TECHNOLOGIES, USA INC.**  
10220 SW Nimbus Ave.  
Suite K-7  
Portland, OR 97223  
Tel: +1-877-4-**RIGOL**-1  
Fax: +1-877-4-**RIGOL**-1  
Email: info@rigol.com

#### JAPAN

**RIGOL JAPAN CO., LTD.**  
5F,3-45-6,Minamiotsuka,  
Toshima-Ku,  
Tokyo,170-0005,Japan  
Tel: +81-3-6262-8932  
Fax: +81-3-6262-8933  
Email: info-japan@rigol.com

---

**RIGOL**® is the trademark of **RIGOL TECHNOLOGIES CO., LTD.** Product information in this document is subject to update without notice. For the latest information about **RIGOL**'s products, applications and services, please contact local **RIGOL** channel partners or access **RIGOL** official website: [www.rigol.com](http://www.rigol.com)