

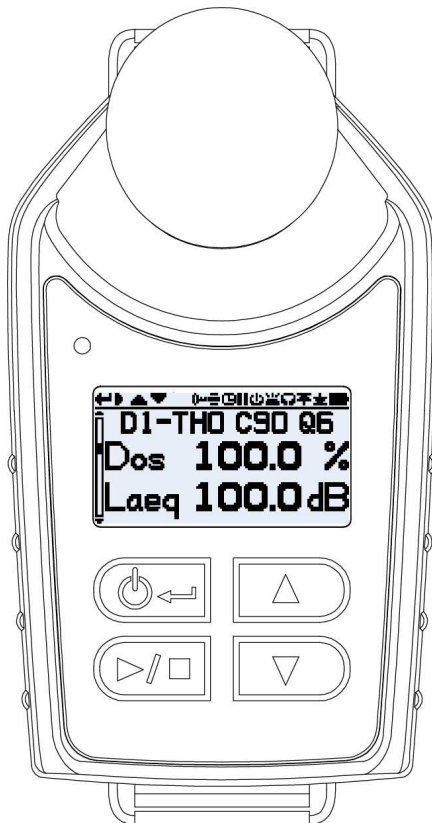





Noise Dosimeter

PCE-MND 10

INSTRUCTION MANUAL



CONTENTS

Title	Page
1. GENERAL DESCRIPTION	1
2. PRINCIPLE OF MEASURING ACCUMULATED NOISE EXPOSURE	1
3. INTRODUCTION TO THE DOSE METER	1
4. SPECIFICATION	3
5. NOMENCLATURE AND FUNCTIONS	6
5-1 The Display and keypad.....	6
5-2 The Windscreen and Microphone	7
5-3 The Mounting Clips	8
5-4 The Charger	9
6. CHARGING THE METER	10
6-1 Charging.....	10
6-2 Linking Chargers Together	11
6-3 Battery.....	11
7. GENERAL OPERATION	12
7-1 Switching on the Meter.....	12
7-2 Calibrating the Meter	14
7-3 Starting a Measurement Run	16
7-4 Locking and Unlocking the Keys.....	16
7-5 Stopping a Measurement Run	17
7-6 Pausing a Measurement Run	17
7-7 Reviewing Measurement Run Data	18
7-8 Switching Off the Meter.....	18
8. CONFIGURING THE METER	18
8-1 LCD Contrast	19
8-2 Date and Time.....	19
8-3 Display Timeout ().....	19
8-4 Selecting Dosimeter Setups.....	20
8-5 Pause Mode ().....	22
8-6 LED Alarms ()	22
8-7 Auto Lock ().....	23
8-8 Autoscroll ().....	23
8-9 Timers ().....	24
8-10 Data Memory Interval Time.....	26
8-11 Language.....	27
8-12 Clear Memory.....	27
9. RECALL THE MEMORIZED DATA	28
10. SOFTWARE INSTALLATION AND OPERATION	28

1. GENERAL DESCRIPTION

Thanks for you're selecting Personal Noise Dose Meter. To ensure that you can get the most from it we recommend that you read the manual carefully before use.

The personal noise dose meter is test equipment to evaluate the noise condition of working environment by measuring the accumulated noise exposure. With this test data, company can ensure the related noise regulation is followed or decide whether or not to apply certain noise reduction action to avoid the acoustic trauma and noise-induced hearing loss occurs to the working personnel.

Protected by:

Taiwan: D174456

U.S.A.: D768,514

China: ZL 2015 3 0269895.4

2. PRINCIPLE OF MEASURING ACCUMULATED NOISE EXPOSURE

DOSE is a parameter used to quantify noise exposure measured in a period, during turns of % noise exposure relative to 90dBA for 8 hours.

i.e. 100% DOSE = 90dBA for 8 hours

This is known as the Criterion. Other criterion are available such as 100% DOSE = 85dBA for 8 hours to meet legislation in different countries.

If the person stayed in this environment for 4 hours, he would receive 50%DOSE.

Also if the noise level was say 93dBA, 3dB higher, a 100% DOSE would be accumulated in only 4 hours, the above example is for a dose meter with 3dB Exchange Rate, where a 3dB increase in sound level corresponds to a doubling energy. A dose meter with 5dB Exchange Rate is also, available where the sound must increase by 5dB to double the dose as required to meet noise legislation in some countries.

3. INTRODUCTION TO THE DOSE METER

The Noise Dose Meter measure the frequency weighted noise exposures and peak sound levels simultaneously.

The meter has the following features:

- Multiple simulated dosimeters (termed D1, D2 & D3)
- Simple operation, including direct read-out of results
- Ten built-in standard dose measurement setups:

OSHA-80, OSHA-90, MSHA-80, MSHA-90, DOD, ACGIH, ISO-85, ISO-90, NR-15 and NHO-01

- Pause function
- Nine user defined measurement setups
- 30 dose (DATA) result stores
- Download of setups from PC to the meter
- Keypad lock protects meter against accidental operation
- Timers support pre-selection of measurement time and duration
- USB PC interface for the charging unit

The meter is ideal for quick on-site surveys and for monitoring personal noise exposure in accordance with European ISO or USA OSHA, MSHA, DOD AND ACGIH standards.

The meter is one measurement ranges: 70 – 140dB, A C & Z RMS weightings, A, C & Z Peak weightings, Fast, Slow & Impulse time weightings, and energy exchange rates (Q) of 3, 4, 5 & 6. In dose measurement mode, it display % dose, % dose projected for an 8 hour period, peak level and measurement duration.

For countries that are subject to European Union regulations or the equivalent ISO standards, the meter measure the daily sound exposure level ($L_{Aeq,8hr}$, Pa^2h according to IEC 61252, which is identical with the $L_{EX,8h}$ required by ISO 1999), while for USA OSHA/MSHA regulations they measure the Time Weighted Average level (TWA).

When used as a sound level meter it display sound level, time-averaged (L_{Aeq}) sound level, peak and sound exposure level (SEL).

4. SPECIFICATION

- **Standard applied:** IEC 61252: 2002, ANSI S1.25-1991 for dose meter and sound exposure meters.
- **Microphone:** 1/2-inch electret condenser microphone
- **Display:** 128x64 graphic
- **Measurement Ranges:**
 - Sound Level Range:** 70 – 140dB (A, C)
90 – 140dB (Z)
 - Peak Ranges:** 103 – 143dB Peak
- **Frequency Weightings:** RMS Detector: A, C and Z
Peak Detector: A, C and Z
- **Frequency Range:** 31.5Hz – 8kHz
- **Time Weightings:** Fast, Slow and Impulse (RMS detector)
- **Exchange Rate:** 3, 4, 5 or 6dB
- **Stabilization Time:** 10 seconds from power on
- **Threshold and Criterion Levels:**
 - From the setup, predefined in the built-in setup according to applicable standards.
 - User-defined setups in the following ranges:
 - Threshold Level: 70 – 90dB in 1dB steps
 - Criterion Level: 70 – 90dB in 1dB steps
- **Overload Indications:** At 0.1dB above the top of the selected measurement range.
- **Under-Range Indications:** At 1dB below the bottom of the selected measurement range.
- **High Level Detector:** 115dB ()
- **Clock:** Real-time clock with calendar.
- **Memory:** Results from 30 measurements and 6101 data sets can be stored for later viewing and download.
- **Measurement Control:**
 - Measurement Duration: May be set 10 to 55 min in 5min steps or 1 to 24 Hrs in 1hr steps.
- **Timers:** Up to 99 timers (automatic start and stop) can be set (maximum up to one month ahead of measurement time).
 - Timer Controlled Started / Stop: Up to 16 timers can be set up from the PC software or meter keypad.

- **Setup:** Ten built-in (predefined) default setups are included.
Nine additional user-defined setups can be stored.

Setup	OSHA -80	OSHA -90	MSHA -80	MSHA -90	DOD	ACGIH	ISO -85	ISO -90	NR -15	NHO -01	User1 -9
Measurement Range (dB)	70-140	70-140	70-140	70-140	70-140	70-140	70-140	70-140	70-140	70-140	70-140
Time Weighting	Slow	Slow	Slow	Slow	Slow	Slow	Fast	Fast	Slow	Slow	Fast
Frequency Weighting	A	A	A	A	A	A	A	A	A	A	A
Peak Frequency Weighting	ACZ	ACZ	ACZ	ACZ	ACZ	ACZ	ACZ	ACZ	ACZ	ACZ	ACZ
Exchange Rate	5	5	5	5	4	3	3	3	5	3	5
Threshold (dB)	80	90	80	90	80	80	70	70	80	80	80
Criterion Level (dB)	90	90	90	90	85	85	85	90	85	85	90
Allow User to Change Setup	No	No	No	No	No	No	No	No	No	No	Yes
Exceedance Time LAS	>115dB	>115dB	>105dB	>105dB	>115dB	>115dB	>115dB	>115dB	>115dB	>115dB	>115dB

● Measurement Parameters

For Dosimeter-1, Dosimeter-2 and Dosimeter-3:

DOSE (Dose), PDOSE (Pdos), TWA (Twa), PTWA (PTwa), LAVG (Lavg), LEPd (Lepd), PLEPd (PLEpd), Exceedance Time (Las>105 or Las >115), LEQ (Laeq, Lceq or Lzeq), SEL (Lae, Lce or Lze), SEPa²h (Ea, Ec, Ez), PEAK (Pka, Pkc or Pkz), LEX8H (Lex8h), PLEX8H (PLex8h), EXPHrs (ExpH), EXPsec (ExpS), NEN.

Only for Dosimeter-1:

Max/Min 18 parameters for A, C, Z and F, S, I weightings.

Statistical analysis 45 parameters L05, L10, L50, L90, L95 for A, C, Z and F, S, I weightings for sampled at 20ms interval into 0.1dB wide classes.

Statistical analysis 5 parameters LAEQ05, LAEQ10, LAEQ50, LAEQ90, LAEQ95 for LAEQ sampled at 1s intervals into 0.1dB wide classes.

Display parameters selecting by PC.

- **Output:** USB interface from the charging unit (The charging unit must be power on).
- **Battery:** 3.7V 470mAH Lithium Polymer (Flat cell).
- **Battery Life time:** Typically > 15 hours at room temperature.
The meter will automatically stop the measurement and store the data before the battery voltage gets too low.
- **Battery Indicator:** Symbol indication battery capacity.
“” indicated flash when voltage is insufficient for operation.
- **Operating Temperature & Humidity:** 0 – 50°C (32 to 122°F), 10 – 90%RH
- **Storage Temperature & Humidity:** -10 – 60°C (14 to 140°F), 10 – 75%RH
- **Size:** 84(L)×49(W)×55(H)mm / 3.3(L)×1.9(W)×2.2(H)inch (with windscreen)
- **Weight:** Approx. 77g (2.7oz), less mounting device.
- **Accessories:** Instruction manual, Charging unit, AC adaptor, Mounting clips, Carrying case, Software CD, USB cable.

CE Certification:

CE	CE-mark indicates compliance EMC Directive
EMC Emission	EN50081-1 (1992): Generic emission standard. Part 1: Residential, commercial and light industry EN50081-2 (1993): Generic emission standard. Part 2: Industrial environment CISPR22 (1993): Radio disturbance characteristics of information technology equipment. Class B Limits FCC Rules, Part 15: Complies with the Limits for a Class B digital device
EMC Immunity	EN50082-1 (1992): Generic immunity standard. Part 1: Residential, commercial and light industry RF immunity implies that sound level indications of 70dB or greater will be affected by no more than ± 1.5 dB EN 50082-2 (1995): Generic immunity standard. Part 2: Industrial environment RF immunity implies that sound level indications of 70dB or greater will be affected by no more than ± 1.5 dB

5. NOMENCLATURE AND FUNCTIONS

5-1 The Display and keypad

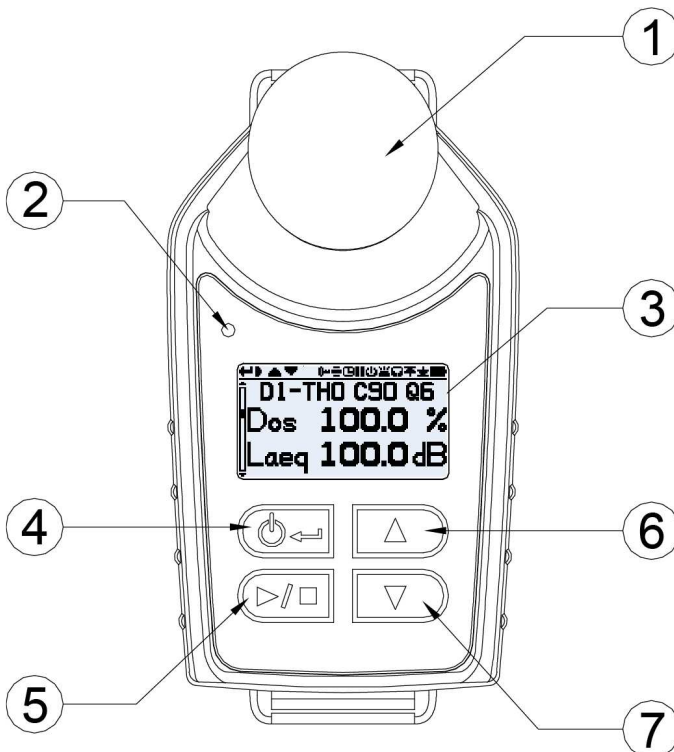

1. Windscreen and microphone

2. LED indicator

Red: Charging indicator.

Blue: A flashing blue LED indicates the measured value has exceeded the alarm setting value.

3. Display: View data and various indicators.

4. key:

 **On/Off key:** Press this key one time to turn on the meter.
Press and hold down this key, A “**Power Off 3, 2, 1**” countdown will appear as the meter is powered off.

 **Enter key:** Confirms action of other keys and settings.

5. ►/■ key:

► **Run key:** In STOP mode, Press and hold down this key, A “**START 3, 2, 1**” countdown will appear as the meter is running.

■ **Stop key:** In Run mode, Press and hold down this key, A “**STOP 3, 2, 1**” countdown will appear as the meter is stop, if the meter PAUSE mode is setting to “**OFF**” otherwise A “**PAUSE 3, 2, 1**” countdown will appear as the meter is pause.

6. ▲ **Up key:** Press this key to scroll through display views or setting up the parameters.

7. ▼ **Down key:** Press this key to scroll through display views or setting down the parameters.

5-2 The Windscreen and Microphone

During use, it is essential that the meter is fitted with the Windscreen. The Windscreen protects the microphone from potential erroneous results due to air movement passing over it but also helps to protect from dust ingress, moisture or minor impact damage.

To calibrate the meter it is necessary to remove the Windscreen to expose the microphone. To unscrew the Windscreen by turning the black ring (not the foam!) in a anticlockwise direction.

It will not normally be necessary to remove the Microphone but to do so unscrew anticlockwise direction. When refitting the Microphone, screw the Microphone on clockwise until it fits tightly.

Following calibration refit the Windscreen, screw the Windscreen in a clockwise and take care do not over tighten; finger tight is sufficient.

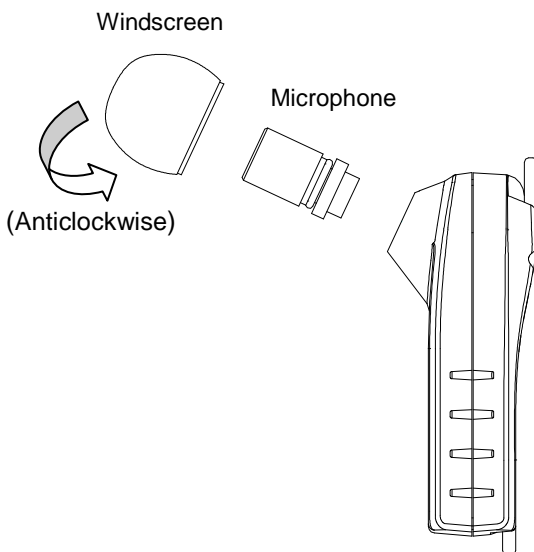

5-3 The Mounting Clips

Upon delivery, the meter will be fitted with the Crocodile-style mounting clips on flexible webbing to aid positioning as they can be fitted to virtually any clothing type. The mounting clip is used for attaching the meter to clothing and should be used where piercing the employees clothing is not desired.

The recommended location for mounting a personal noise exposure meter in a position close to the ear (10 – 15 cm). The meter should therefore be mounted on the apex of the shoulder to avoid reflections from the head which might otherwise affect the measurements. Consult your local Legislation and Standards for more information.

All mounting clips are attached the meter by two screws. By removing the screws with the screwdriver the mounting clips can be changed.

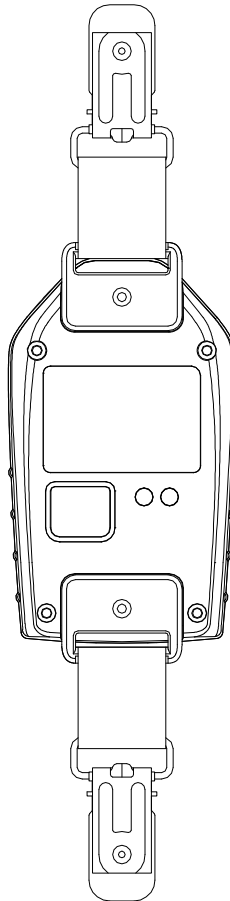

5-4 The Charger

The charger is a drop-in intelligent charger unit, required to download the meter memory and/or to charge the meter internal Lithium Polymer battery. The charger consists of the charger base, AC adaptor, link cable and the charger link plate. Note that the meter should only be charged in non-hazardous areas in the absence of any flammable atmospheres.



Link cable

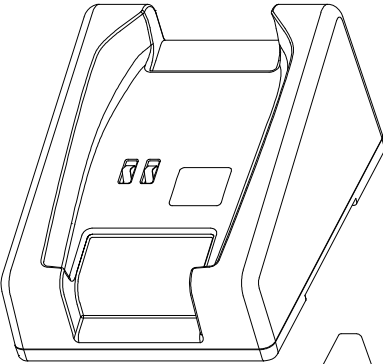

Charger

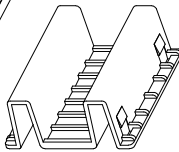

Charger link plate

6. CHARGING THE METER

6-1 Charging

The meter uses internal Lithium polymer battery. Ensure the meter is fully charged prior to use by placing in the charger. Note the meter will fit into charger unit regardless of which mounting clips are attached.

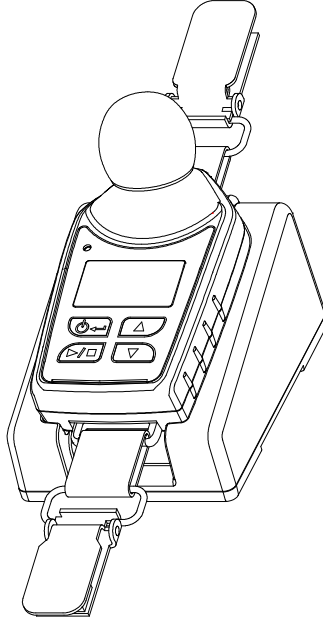

Ensure the AC adapter is connected and the supply is switched on. The meter will automatically switch on and display how much charge is within the meter. After approximately 20 seconds the display will blank. Pressing either the ▲, ▼ or ► key will wake the display for a further 20 seconds to check progress. When the meter is charging the red LED will on. The meter will display "FULL" once charging is complete and the LED on the front of the meter will turn purple.

The LCD display when the meter is on and put on the battery charger. →

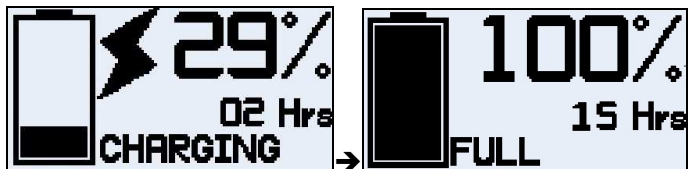

The LCD display when the meter is off and put on the battery charger. →

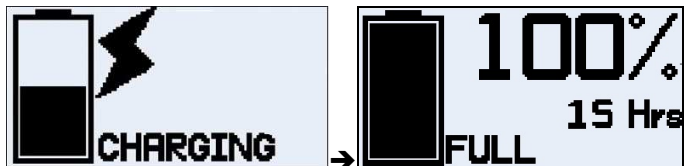

6-2 Linking Chargers Together

The charger can be linked to the another charger via the link cable and the charger link plate. Up to 4 chargers can be linked.

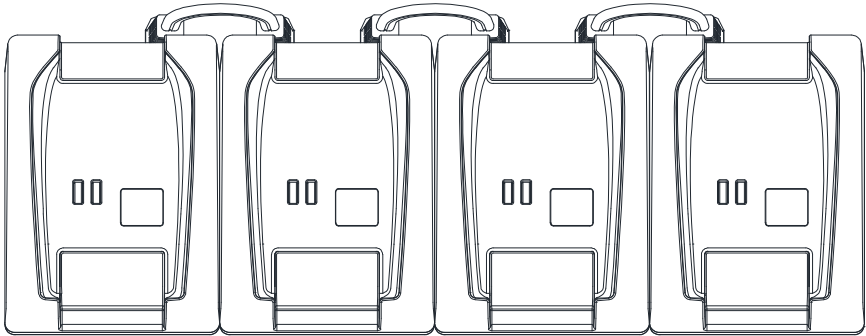

6-3 Battery

The meter battery care best practices.

The meter incorporates a Lithium Polymer battery as a power source that with proper care should give years of operational service. (Three years is typical)

Proper care includes these best practices.

- After use, it is best to charge the meter using the recommended charger prior to storage for a prolonged period. A prolonged period is considered to be 2 or more months. If the meter is to be stored for an even longer period, it is best to take the meter out of storage and re-charge the meter every 2 – 3 months.
- Charge the meter in the recommended charger before attempting to turn it on if the meter has not been used for a prolonged period or was stored in a low battery condition.
- It is best not to store the meter for any period of time in low battery condition.
- If not using the meter it is best to keep the meter in a powered up the recommended charger.

7. GENERAL OPERATION

7-1 Switching on the Meter

Once the meter is switched on by pressing the  key, it will display a start-up sequence, shown in as follows. This displays the meter firmware version (e.g. Rev V1.0) and the current time and date, followed by the meter series number and the “Custom Text” screen. The series number and text can be configured using the CD software by PC.



Rev V1.0
2016-01-01
12:59:59

↓(1sec)



SN: 0123456789A
USER Data 1
Data 2
Data 3

↓(1sec)



Welcome

If the Auto scroll mode has been disabled pressing the ▲ or ▼ key will scroll through the available results from the last run depending upon how the meter was configured.

12:59:59 077
Splaf
140.0 dB

↓ (▼ key)

2016-01-01
10 Hrs
Memory 101Hr

↓ (▼ key)

D1-TH80,C90,Q5
Dur 00:01:00
Dose 100.0 %

↓ (▼ key)

D1-TH80,C90,Q5
Pdos 100.0 dB
Twa 92.2 dB

↓ (▼ key)

D1-TH80,C90,Q5
PTwa 92.2 dB
Lavg 100.0 dB

↓ (▼ key)

D1-TH80,C90,Q5
Laeq 100.0 dB
Splaf 92.2 dB

↓ (▼ key)

D1-TH80,C90,Q5
Lafmx 90.0 dB
00:01:00

(▼ key) ←

D1-TH80,C90,Q5
Lcsmn 90.0 dB
00:01:00

↑ (▼ key)

D1-TH80,C90,Q5
Lcsmx 90.0 dB
00:01:00

↑ (▼ key)

D1-TH80,C90,Q5
Lcfmn 90.0 dB
00:01:00

↑ (▼ key)

D1-TH80,C90,Q5
Lcfmx 90.0 dB
00:01:00

↑ (▼ key)

D1-TH80,C90,Q5
Lasmn 90.0 dB
00:01:00

↑ (▼ key)

D1-TH80,C90,Q5
Lasmx 90.0 dB
00:01:00

↑ (▼ key)

D1-TH80,C90,Q5
Lafmn 90.0 dB
00:01:00

→ (▼ key)

7-1-1 Error Messages at Power Up

If there are any error messages they will appear after the start-up screens:

Battery < 1 Hr

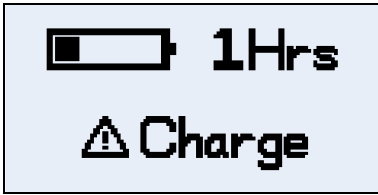

Memory

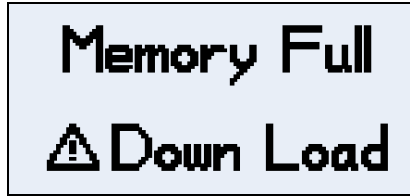

Warning messages appear when there is less than 1 hours charge or memory full. Press any key to return to the default screen or alternatively these error messages will time-out after 30 seconds. Please either re-charge, download and /or erase data as required before continuing with a new measurement run.

7-2 Calibrating the Meter

It is best practice (and often mandatory) to field calibrate each meter both before and after use. Which will also allow the target calibration level to be set as shown on the calibrator's own calibration certificate, nominally 94.0dB, 114.0dB or OFF selecting by PC.

Note: The meter will not enter the calibration mode if a measurement run is taking place. If a run is in progress, stop the run according to section 7-5.

The windscreen should be removed prior to calibration. Please refer to section 5-2.

Push the sound calibrator over the microphone as shown. The calibrator should be pushed on without twisting until fully home and switched on.

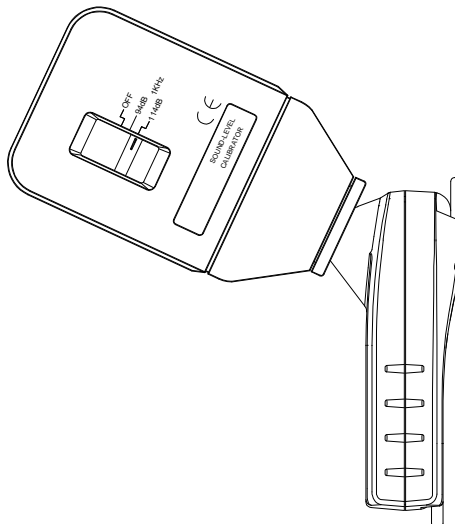

The meter will automatically recognize a 1kHz calibration tone and enter the calibration mode.

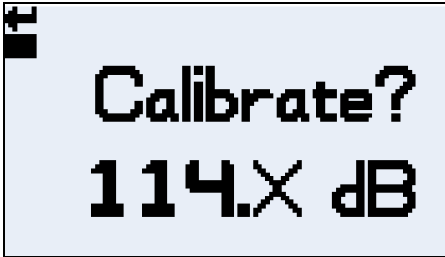

Press \downarrow key to confirm you wish to calibrate, or press \blacksquare key to cancel the calibration. It will take a few seconds to automatically calibrate to 94.0dB or 114.0dB during which time a progress bar is displayed as shown.

\downarrow (\leftarrow key)



Once the meter has successfully calibrated the "CAL OK" message will appear.

The meter is ready to take a measurement once the calibrator has been removed and the Windscreen re-fitted.

You may need to consult local regulations or standards if the "before" and "after" calibration values differ by more than (typically) +/- 0.5dB e.g. section 12.2 of ISO 9612: 2009 suggest that measurement is re-taken.

\downarrow

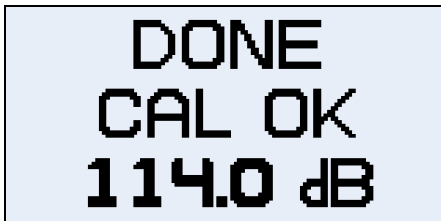

\downarrow

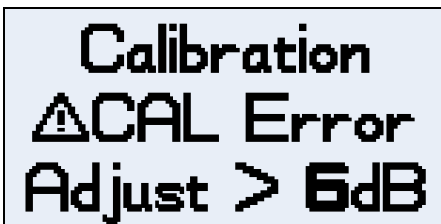

7-3 Starting a Measurement Run

Before starting a measurement run, ensure the Windscreen is re-fitted according to section 5-2 and ensure there is sufficient battery life and memory by looking at the default screen shown in section 7-1.

If necessary, charge the meter as described in section 6-1, if the memory is fully either clear it as described in section 8-10 or download the data to PC.

Note: If the battery available is less than one hour or memory is full, the run will not start.

Timers are also available to automatically start and stop a measurement run or halt a run after a fixed period. These options may be selected in the Configuration menu, see section 8-9

To manually start a measurement run, press and hold down ► key which will initiate a 3 second countdown as shown. The ► keys must remain depressed during the countdown for the measurement run to begin; releasing during the 3-2-1 countdown will cease the operation.



Once the measurement has begun, the “►” mark is flashing displayed in the top left of the screen. The display will cycle between the section 7-1 screens if the Autoscroll mode has been selected in the configuration menu (see section 8-8) or may be scrolled manually by pressing either the ▲ or ▼ key.

7-4 Locking and Unlocking the Keys

It is recommended that the meter is locked during a run to prevent the wearer tampering and this can be done automatically upon the start of a run having first selected “Auto Lock” in the configuration menu (see section 8-7) or manually as follows.

Press ► key 3 times to enter the “Lock” mode, the “” mark is displayed.

To unlock the meter, press ► key 3 times, the “” mark is disappear.

7-5 Stopping a Measurement Run

If the meter is locked, unlock as described in section 7-4 above. To stop the current measurement run, press and hold down the **■** key for the period of the 3 second countdown (releasing during the countdown will cease the operation).



The display will then show the data from the measurement run that had just been completed. See section 7-1.

A new measurement run can be started immediately by following section 7-3.

7-6 Pausing a Measurement Run

Some measurement strategies may require a measurement run to be PAUSED e.g. during a worker's lunch break. To enable this function it must first be selected in the configuration menu (see section 8-5).

When a measurement run is in progress, the action of pressing and hold down the **■** key for the period of the 3 second countdown to enter the pause mode (releasing during the countdown will cease the operation).

Note: During PAUSED mode, all time history profile data is recorded and “**paused event**” markers are saved into the data set. Cumulative values shown on the display represent the measured data and excluded the time and noise level during the paused intervals.

From the PAUSED screen:

- to continue the run, press the **▶** key as prompted by the “**▶**” mark.
- to stop the run, press the **◀** key as prompted by the “**■**” mark and “**STOP Sure?**” confirmation message will appear for 30 seconds then default back to the PAUSE screen if no action is taken.
- To stop the run, press the **◀** key as prompted by the “**■**” mark.
- to return to the paused mode press the **▶** key.

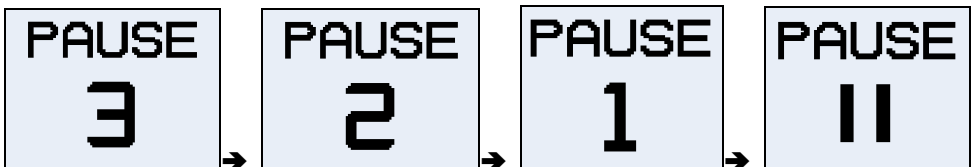

7-7 Reviewing Measurement Run Data



As soon as a measurement run has been stopped, the meter will automatically display result from last measurement run. The display will cycle between the screens as section 7-1 if the Auto Scroll mode has been selected in the configuration menu (see section 8-8) or may be scrolled manually by pressing either the ▲ or ▼ key.

7-8 Switching Off the Meter

To switch off the meter, press and hold down the  key for the duration of the 3 second 3-2-1 countdown (releasing during the countdown will cease the operation).



8. CONFIGURING THE METER

The configuration menu is accessed by press the  key to turn on the meter, then press  key to enter the configuration screen.

Press  key to enter the setting mode and press  key to exit.

The setting menu is used to:







↓ ( key)



- LCD Contrast: Set the display's contrast
- RTC: Adjust the date and time
- LCD APO: Set the display timeout
- Dosimeter: Select the dosimeter setup
- Pause: Select/deselect the Pause function
- LED Alarm: Select/deselect visual alarms
- Auto Lock: Select/deselect Auto Lock of the keys
- Auto Scroll: Select/deselect Auto Scroll of the display
- Timers: Select/deselect Timers
- Interval: Set the data memory interval time
- Language: Select language
- Clear Memory: Clear the memory









Any changes made will become the default configuration.

8-1 LCD Contrast

Set the display contrast by press  key 2 times then press ,  keys to choose from 1 to 10 brightness levels, and press  key to save, press  key to exit.







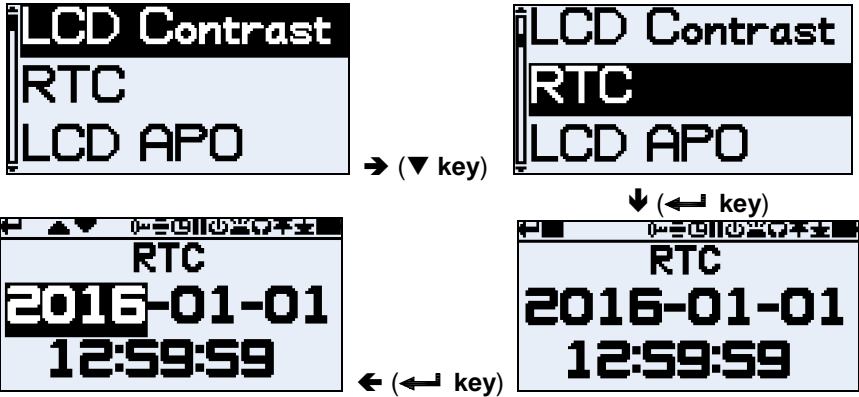

8-2 Date and Time

Adjust the date and time by press  key to select "RTC" then press  key 2 times to make adjustments. Press  key to move the cursor to right or press  key to left then press ,  keys to adjust. Press  key to save, press  key to exit.



8-3 Display Timeout ()

The display can be left permanently on (which will reduce battery life) or will timeout after the selected interval of 5, 10, 20 seconds, 1 or 5 minutes.

Set the display time out by press  key to select "LCD APO" then press  key 2 times to make select. Press ,  keys to select, press  key to save and press  key to exit.

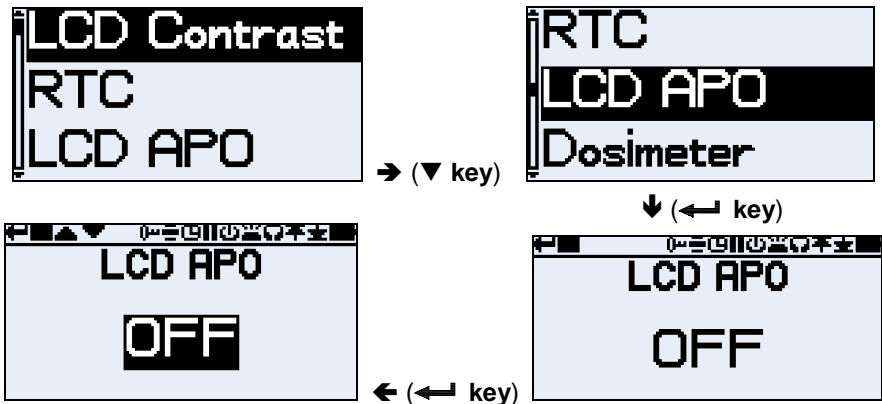

8-4 Selecting Dosimeter Setups

The meter has up to 3 simultaneous dosimeters, Dosimeter-1 Dosimeter-2 and Dosimeter-3 which only determine what is displayed on screen and not, but all is calculated and saved to memory for later download and analysis. The Dosimeter-1 cannot be disabled. Additional Dosimeter-2 and Dosimeter-3 may be selected to display any of the other available configurations.

The meter can be configured to display any one of ten built-in (predefined) default setups (OSHA-80, OSHA-90, MSHA-80, MSHA-90, DOD, ACGIH, ISO-85, ISO-90, NR-15 and NHO-01) or any one of nine full custom configurable from USER-1 to USER-9.

The Dose dates and Noise parameters available for display on screen and is achieved using the meter CD software by PC.

8-4-1 Pre-difined Dosimeter Setups

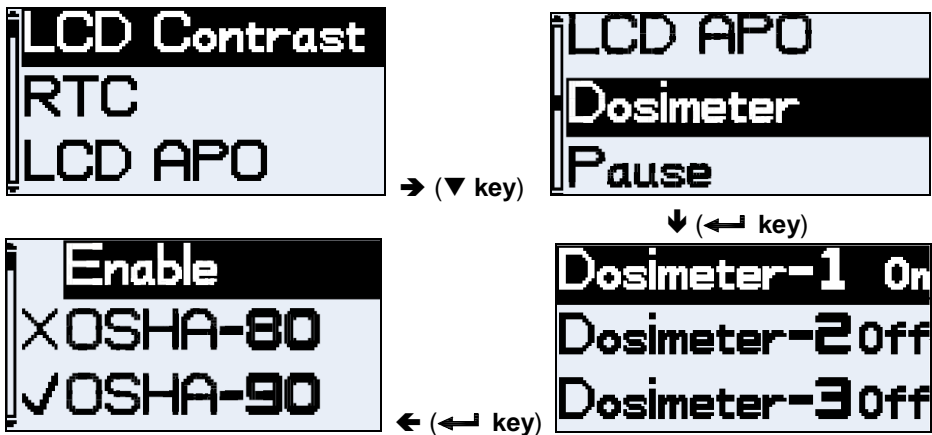

Pre-difined the Dosimeter setup by press ▼ key to select “**Dosimeter**” then press ← key 2 times to select the default setups. Press ▲, ▼ keys to select the desired setups from “**OSHA-80**” to “**NHO-01**” then press ← key to save and press ■ key 2 times to exit.

8-4-2 Customised Dosimeter Configurations

Any of the general noise parameters listed below can be configured.

Reference setup: Select from OSHA-80 to NHO-01

Time weighted: Select Fast, Slow, or Impulse

Threshold: (THnn) Adjustable 70 to 90dB in 1dB steps

Criterion: (Cnn) Adjustable 70 to 90dB in 1dB steps

Exchange Rate: (Qn) Adjustable 3 to 6dB in 1dB steps

Exceedance level (LAS): Adjustable 70 to 140dB in 5dB steps

Projected Work duration: Adjustable 10 to 55 min in 5 min steps or
1 to 24 Hrs in 1 hr steps



↓ (▼ key)

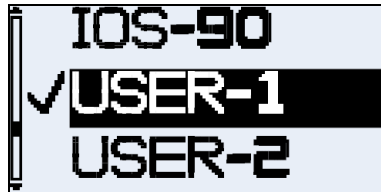

↓ (← key)



↓ (← key)



↓ (← key)



In the pre-defined setup mode, press ▲, ▼ keys to select the desired customized configuration from “USER-1” to “USER-9” then press ← key to confirm. Press ▲, ▼ keys to review the parameters, if you will change the parameters press ← key to confirm then press ▲, ▼ keys to change the desired parameters value and press ← key again to save.

When all parameter configuration is finished, press ■ key to exit.

8-5 Pause Mode (//)

Enable the pause mode so that you may temporarily stop a measurement run, for example, during the worker's break. During a Pause, all data is recorded. Cumulative values will represent the measured data and will exclude the paused intervals.

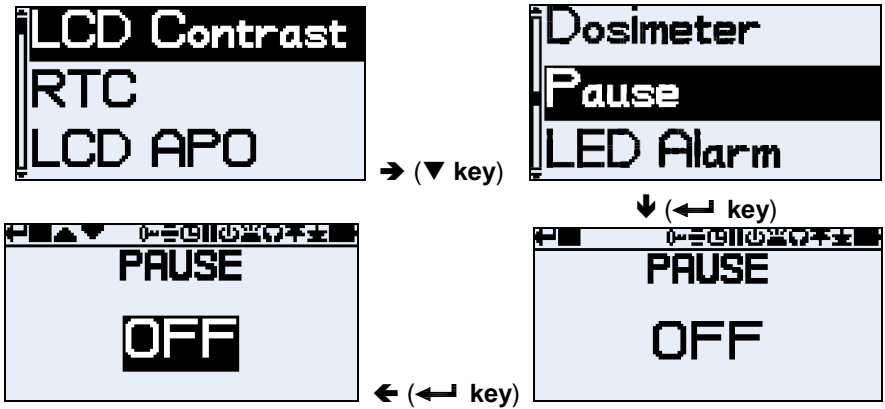

Select the Pause function by press ▼ key to select "Pause" then press ← key to review. Press ■ key to accept or press ← key then press ▼ key to change and press ← key to confirm.

8-6 LED Alarms (🚨)

LED Alarm criteria can be set by using the meter CD software by PC.

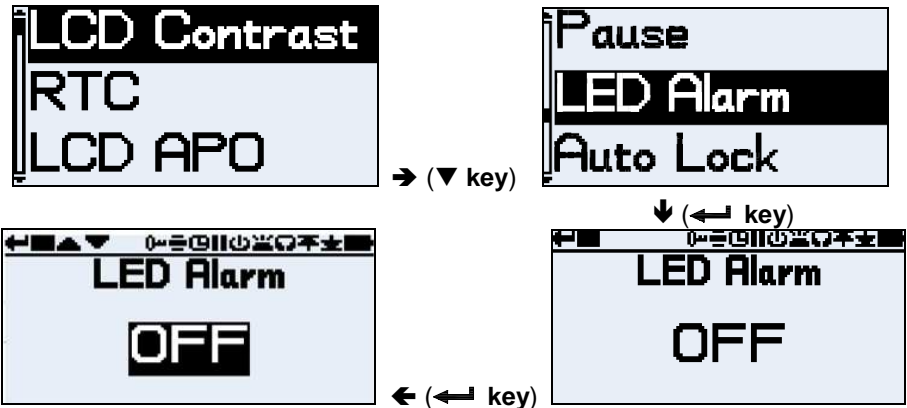

Select the LED alarm by press ▼ key to select "LED Alarm" then press ← key to review. Press ■ key to accept or press ← key then press ▼ key to change and press ← key to confirm.

8-7 Auto Lock ()

Selecting Auto Lock “lock” the display in run mode.

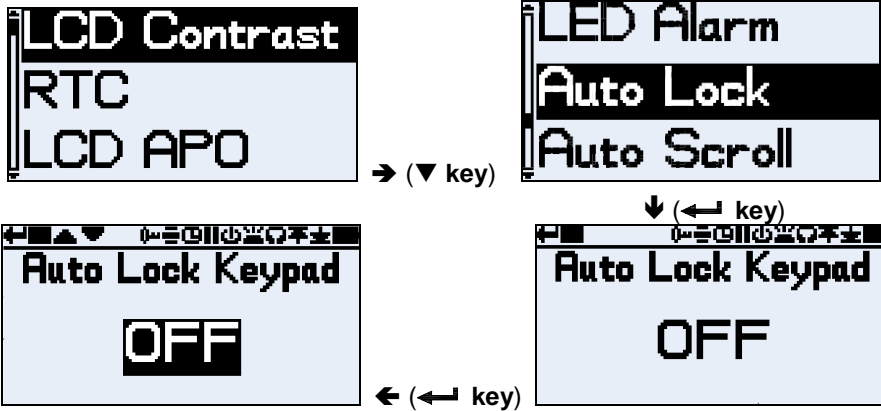

Select the Auto Lock by press ▼ key to select “Auto Lock” then press ← key to review. Press ■ key to accept or press ← key then press ▼ key to change and press ← key to confirm.

8-8 Autoscroll ()

If selected the display will automatically scroll from one screen to the next (otherwise the screen has to be advanced manually).

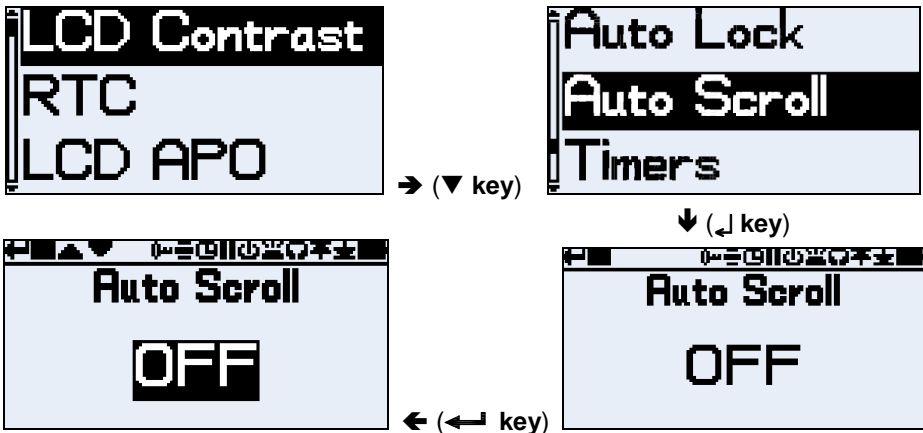

Select the Autoscroll by press ▼ key to select “Auto Scroll” then press ← key to review. Press ■ key to accept or press ← key then press ▼ key to change and press ← key to confirm.

8-9 Timers ()

To select a timer run.

8-9-1 No-Cycle Timer Run

The no cycle timer means the Start-Time and Duration-Time is valid only one time.



↓ (▼ key)

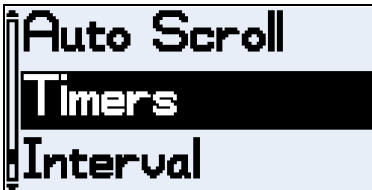

↓ (← key)



↓ (← key)



↓ (▼ key)



↑ (← key)

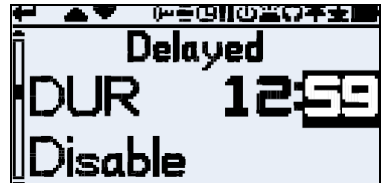

↑ (← key)



↑ (← key)



→ (← key)

To select no-cycle timer run by press ▼ key to select “Timers” then press ← key to enter this mode. Press ▼ key to select “Delayed” then press ← key to review the Start time, press ▼ the key to review the Duration time. If you will change the Duration time and the Start time, using ← key to position the cursor on the date or time element to adjust then using ▲, ▼ keys to setting the selected date or time element value including the “Enable” or “Disable” selected. Press ← key to confirm then press ■ key to exit.

8-9-2 Auto-Cycle Timer Run

The auto-cycle timer run means the start-time and the duration-time is valid at the repeat setting number from 1 to 99 times.



↓ (← key)



↓ (▼ key)



↓ (← key)



→ (▼ key)



↑ (← key)



↑ (← key)



In the Timers mode, press ▼ key to select “Repetitive” then press ← key to review the Start-time and Duration-time, press ▼ key to review the Repeat times. If you will change the data, using ← key to position the cursor to the time element to adjust then using ▲, ▼ keys to setting the selected time element value including the Repeat number from 01 to 99 and the “Enable” or “Disable” selected. Press ← key to confirm then press ■ key to exit.

8-10 Data Memory Interval Time



↓ (▼ key)



↓ (← key)

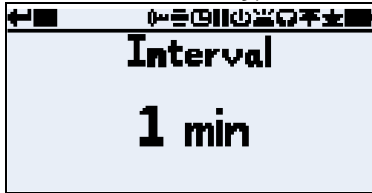

→ (← key)



↑ (■ key)



↑ (▼ key)



The LAVG, LEQ, LCPK and LZPK time-history data is saved at an data memory interval time for every run and are available following download. Data memory interval time can be set by press ▼ key to select "Interval" then press ← key to review. Press ■ key to accept or press ← key then press ▼ key to select 1, 5, 10 or 30 minute, 1 or 2 hours and press ■ key to confirm.

8-11 Language



↓ (▼ key)

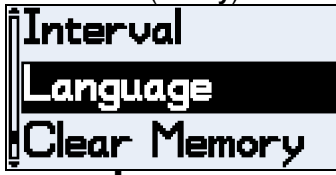

↓ (← key)



→ (← key)



↑ (■ key)



↑ (▼ key)



Set your preferred language English, Portugues or Espanol.
Select language by press ▼ key to select “**Language**” then press ← key to review, press ■ key to accept or press ← key then press ▼ key to select and press ■ key to confirm.

8-12 Clear Memory



→ (▼ key)



↓ (← key)











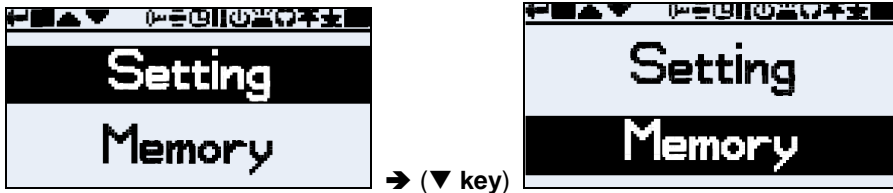

← (← key)



In the setting mode, press ▼ key to select “**Clear Memory**” then press ← key to enter this mode. Press ▼ key to select “**YES**” then press ← key to the additional screen “**Clear Memory ⚠ Sure ?**” is displayed to check that you wish to progress since once cleared all stored runs will be lost.
Press ← key to confirm then press ■ key to exit.

9. RECALL THE MEMORIZED DATA



Press the  key to turn on the meter, then press  key again to enter the configuration screen. Press  key to select “**Memory**” then press ,  keys to select the desired memorized data to be recall. Press  key to confirm and display the memorized data. Press ,  key or autoscroll display the memorized data. Press  key to the next memorized data to be recall. Press  key two times to exit.

10. SOFTWARE INSTALLATION AND OPERATION

- For the detailed instruction, please refer to the content of attached CD-ROM, which has the complete instruction of software operation and relevant information.

PCE Instruments contact information

Germany

PCE Deutschland GmbH
Im Langel 26
D-59872 Meschede
Deutschland
Tel.: +49 (0) 2903 976 99 0
Fax: +49 (0) 2903 976 99 29
info@pce-instruments.com
www.pce-instruments.com/deutsch

United Kingdom

PCE Instruments UK Ltd
Trafford House
Chester Rd, Old Trafford
Manchester M32 0RS
United Kingdom
Tel: +44 (0) 161 464902 0
Fax: +44 (0) 161 464902 9
info@pce-instruments.co.uk
www.pce-instruments.com/english

The Netherlands

PCE Brookhuis B.V. Institutenweg
15
7521 PH Enschede
Nederland
Telefoon: +31 (0)53 737 01 92
info@pcebenelux.nl
www.pce-instruments.com/dutch

France

PCE Instruments France EURL
23, rue de Strasbourg
67250 Soultz-Sous-Forêts
France
Téléphone: +33 (0) 972 3537 17
Numéro de fax: +33 (0) 972 3537 18
info@pce-france.fr
www.pce-instruments.com/french

Italy

PCE Italia s.r.l.
Via Pesciatina 878 / B-Interno 6
55010 Loc. Gragnano
Capannori (Lucca)
Italia
Telefono: +39 0583 975 114
Fax: +39 0583 974 824
info@pce-italia.it
www.pce-instruments.com/italiano

United States of America

PCE Americas Inc.
1201 Jupiter Park Drive, Suite 8
Jupiter / Palm Beach
33458 FL
USA
Tel: +1 (561) 320-9162
Fax: +1 (561) 320-9176
info@pce-americas.com
www.pce-instruments.com/us

Spain

PCE Ibérica S.L.
Calle Mula, 8
02500 Tobarra (Albacete)
España
Tel. : +34 967 543 548
Fax: +34 967 543 542
info@pce-iberica.es
www.pce-instruments.com/espanol

Turkey

PCE Teknik Cihazları Ltd.Şti.
Halkalı Merkez Mah.
Pehlivan Sok. No.6/C
34303 Küçükçekmece - İstanbul
Türkiye
Tel: 0212 471 11 47
Faks: 0212 705 53 93
info@pce-cihazlari.com.tr
www.pce-instruments.com/turkish

Denmark

PCE Instruments Denmark ApS
Birk Centerpark 40
7400 Herning
Denmark
Tel.: +45 70 30 53 08
kontakt@pce-instruments.com
www.pce-instruments.com/dansk