

subject to technical alterations

type: L
range: 40 - 90 mm
range of indication: 39,5 - 90,5 mm
digital step: 0,01 mm
scale interval: -
measuring force: 1 - 1,8 N
weight: 420 g

acceptable deviations
VDI/VDE/DGQ 2618 Bl. 12.1/13.1)
max. permissible errors "G": 0,05 mm
repeatability "r": 0,03 mm
reference temperature: 20° C
operation temperature: 10° C - 30° C
storage temperature: -10° C - 50° C

scale: 1:2
drawing-nr.: DAB-L440-K-e
date of issue: 05.03.2021
name: B. Schmidt
revision status:
revision date:

measuring capacity

		measuring range M_{eb} [mm]													
		40	42	44	46	48	50	55	60	65	70	75	80	85	90
groove depth A [mm]	0	0 / 157	0 / 164	0 / 166	0 / 169	0 / 171	0 / 173	0 / 178	0 / 192	0 / 192	0 / 192	0 / 192	0 / 192	0 / 192	0 / 192
	1		2,5 / 163	2,5 / 165	2,5 / 167	2,5 / 169	2,5 / 171	2,5 / 176	2,5 / 184	2,5 / 192	2,5 / 192	2,5 / 192	2,5 / 192	2,5 / 192	2,5 / 192
	2			2,5 / 164	2,5 / 166	2,5 / 168	2,5 / 170	2,6 / 175	2,6 / 181	2,6 / 192	2,6 / 192	2,6 / 192	2,6 / 192	2,6 / 192	2,6 / 192
	3				2,6 / 165	2,6 / 167	2,6 / 169	2,6 / 174	2,7 / 179	2,7 / 192	2,7 / 192	2,7 / 192	2,8 / 192	2,8 / 192	2,8 / 192
	4					2,6 / 166	2,6 / 168	2,7 / 173	2,7 / 178	2,8 / 192	2,8 / 192	2,9 / 192	2,9 / 192	3,0 / 192	3,0 / 192
	5						2,7 / 167	2,8 / 171	2,9 / 176	3,0 / 182	3,0 / 192	3,0 / 192	3,1 / 192	3,1 / 192	3,2 / 192
	B / L														

B = minimum groove width [mm]
L = maximum usable arm length [mm]

Example: $M_{eb} = 46$ B = 2,5
A = 2 L = 166

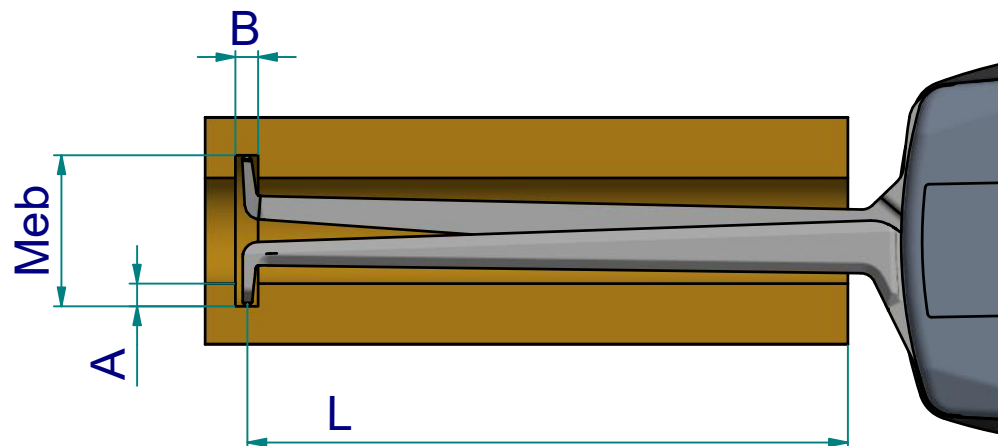

subject to technical alterations

drawing-nr.: DAB-L440-K-e
date of issue: 05.03.2021
name: B. Schmidt

revision status:
revision date:

interface as accessories available:

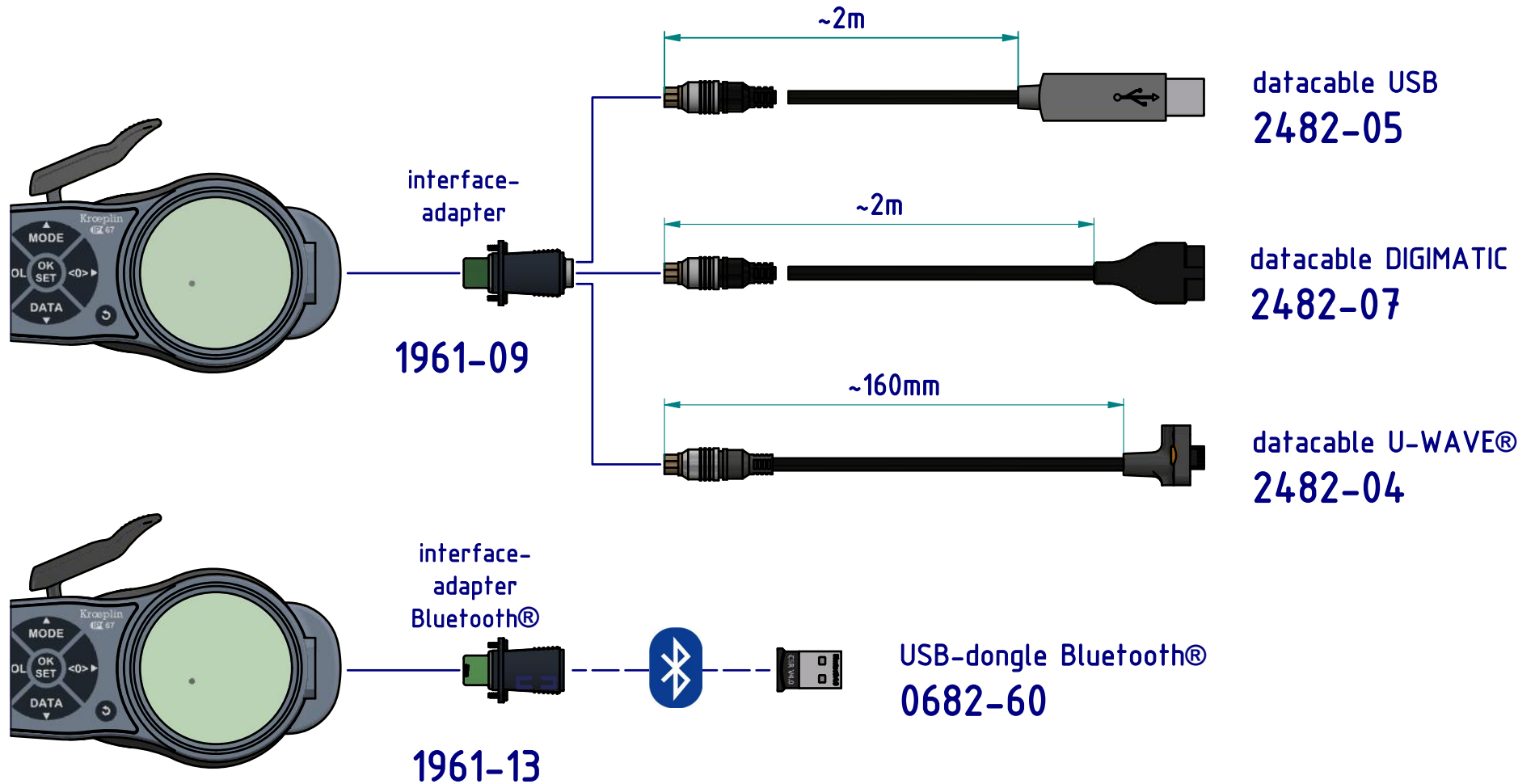

subject to technical alterations

drawing-nr.:	DAB-L440-K-e
date of issue:	05.03.2021
name:	B. Schmidt
revision status:	
revision date:	