

M60 Handheld Thermography Camera



HIKMICRO M60 handheld camera is specially designed for temperature measurement. It's equipped with a 640 × 480 resolution thermal detector. It helps the staff to quickly find the high-temperature targets in the environment. Meanwhile, it provides assistance with decisions and ensures safety. The device is mainly applied to various industries, such as Building, HVAC, auto industry, etc.

Key Feature

- High sensitivity thermal module with 640 × 480 resolution
- SuperIR up to 1280 × 960 (1,228,800 pixels)
- Supports multiple palettes
- High quality optical module with 8 MP resolution
- Bi-spectrum image fusion, picture-in-picture preview
- Wide temperature measurement range: -20°C to 650°C
- High temperature measurement accuracy: Max. ($\pm 2^{\circ}\text{C}/3.6^{\circ}\text{F}$, $\pm 2\%$), for ambient temperature 15°C to 35°C (59°F to 95°F) and object temperature above 0°C (32°F)
- 640 × 480 resolution 3.5" LCD touch display
- Long-distance laser light supplement for thermography targets
- LED light supplement makes the device a torch in required scenarios
- 1.0x to 8.0x continuous digital zoom
- Supports remote album access, download and quick report with APP

▪ Specification

Infrared Image	
IR Resolution	640 x 480 (307,200 pixels)
SuperIR	1280 x 960 (1,228,800 pixels)
NETD	< 35 mK (@ 25°C, F#=1.0)
Image Frequency	25 Hz
Detector Pitch	17 µm
Spectral Range	7.5 to 14 µm
Focal Length	15 mm
F-number	F1.0
Field of View (FOV)	41.9° × 33.3°
Spatial Resolution (IFOV)	1.13 mrad
Min. Focus Distance	0.3 m (0.98 ft)
Focus Mode	Manual Focus
Image Display	
Visual Camera	3264 × 2448 (8 MP)
Display	640 × 480 Resolution, 3.5" LCD Touch Screen
Screen Brightness	Manual
Digital Zoom	1.0x to 8.0x continuous
Color Palettes	White Hot, Black Hot, Rainbow, Ironbow, Red Hot, Fusion, Rain, Blue Red
Focus Mode Palette	Above/Below/Interval
Color Alarm	Above/Below/Interval/Insulation
Image Modes	Thermal/Visual/Fusion/PIP/Blending
Measurement and Analysis	
Object Temperature Range	-20°C to 650°C (-4°F to 1202°F)
Accuracy	Max (±2°C/3.6°F, ±2%)
Measurement Tools	Center Spot, Hot Spot, Cold Spot User-definable: 10 spots, 1 line, 5 rectangles, and 5 circles
Level and Span Mode	Auto/Manual/1-Tap Touch-screen
Data Storage and Communication	
Storage Media	Removable 64 GB Micro SD Card
Image Storage Capacity	Approx. 35,000 Images
Annotations	Voice note: max. 60 seconds; Text note: max. 200 characters
Video Storage Capacity	Approx. 54 hours
Video File Format	MP4 video and radiometric video
General	
Wi-Fi	802.11 b/g/n (2.4 GHz and 5 GHz)
Bluetooth	Bluetooth 4.2
USB Interface	USB Type-C
LED Light	Yes
Laser	Yes, Class II, Wavelength: 650 nm; Power: < 1 mW
Battery Type	Interchangeable and rechargeable Li-ion battery

Battery Operating Time	Approx. 4 hours
Battery Charging Time	Approx. 4 hours fully charged
Power Saving Mode	No
Protection Level	IP54
Drop Test Height	2 m (6.56 ft)
Safety	IEC 61010-1
EMC	EN55032, EN61326-1, EN61000-3-2, EN61000-3-3, EN IEC 61000-6-2, EN IEC 61000-6-3
Vibration	0.03 g ² /Hz (3.8 g), 2.5 g IEC 60068-2-6
Shock	25 g, IEC 68-2-29
Working Temperature Range	-20°C to 50°C (-4°F to 122°F)
Relative Humidity	< 95% non-condensing
Storage Temperature Range	-20°C to 70°C (-4°F to 158°F)
Weight	Approx. 686 g (1.51 lb)
Dimension	244 × 100 × 104 mm (9.6 × 3.9 × 4.1 in)
Tripod Mounting	UNC ¼"-20

▪ Available Model

M60

▪ Dimension

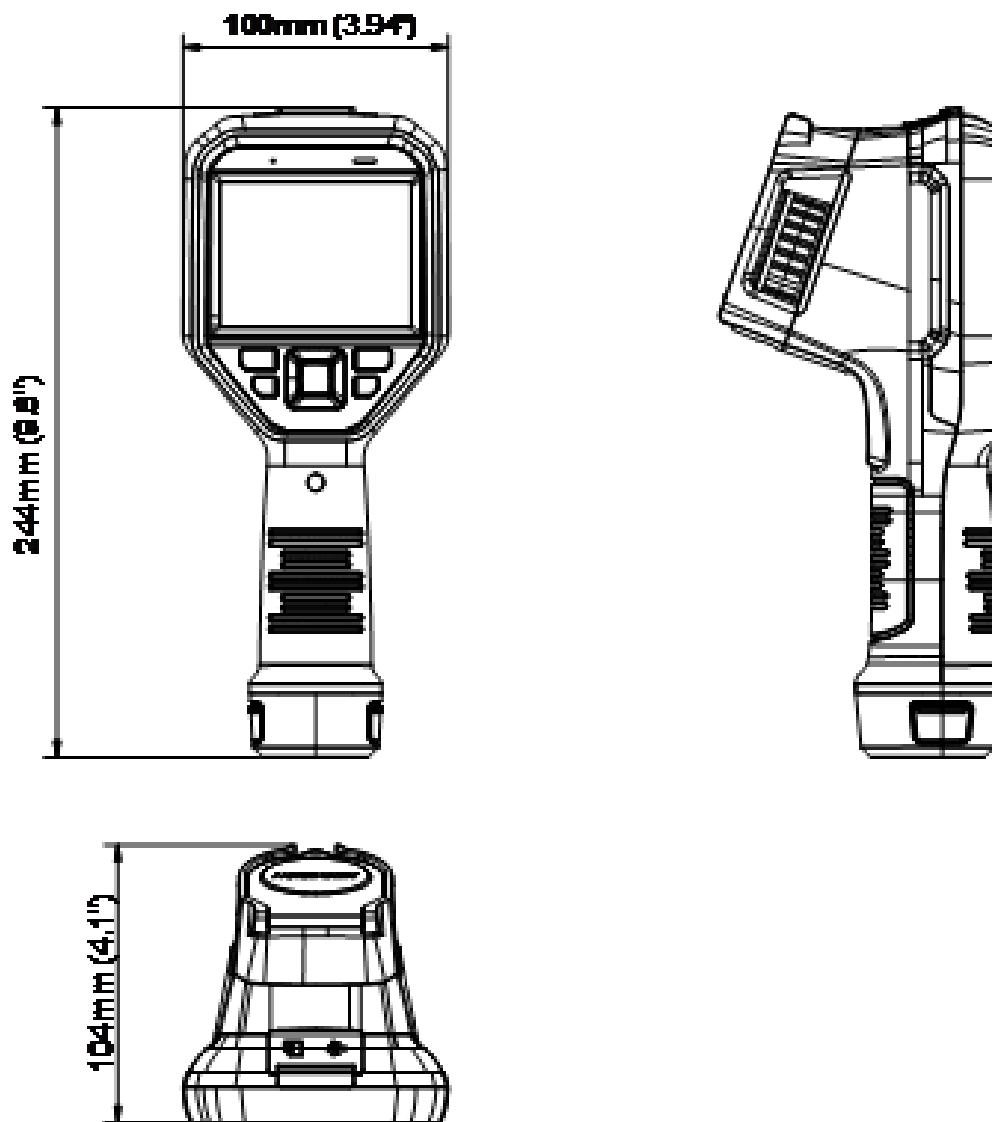

Unit: mm (inch)

▪ Optional Accessories



E097-13-1S1P26650



HM-5202ZC









HM-SP01-POUCH



HM-2925ZJ-TM01-
BRACKET

COMPLIANCE NOTICE: The thermal series products might be subject to export controls in various countries or regions, including without limitation, the United States, European Union, United Kingdom and/or other member countries of the Wassenaar Arrangement. Please consult your professional legal or compliance expert or local government authorities for any necessary export license requirements if you intend to transfer, export, re-export the thermal series products between different countries.



 HIKMICRO Thermography  hikmicro_thermography  HIKMICRO Thermography  HIKMICRO  info@hikmicrotech.com  <http://hikmicrotech.com/en>

© 2023 Hangzhou HIKMICRO Sensing Technology Co., Ltd. All Rights Reserved.
Data subject to change without notice!