

# C.A 6030



**Loop and residual current device tester**

Thank you for purchasing a **C.A 6030 loop and RCD tester**.

For best results from your instrument:

- **read** these operating instructions carefully,
- **comply with** the precautions for use.



WARNING, risk of DANGER! The operator must refer to these instructions whenever this danger symbol appears.



Equipment protected by double insulation.



Battery.



Earth.



The CE marking indicates conformity with European directives, in particular LVD and EMC.



The rubbish bin with a line through it indicates that, in the European Union, the product must undergo selective disposal in compliance with Directive WEEE 2002/96/EC. This equipment must not be treated as household waste.

#### Definition of measurement categories

- Measurement category IV corresponds to measurements taken at the source of low-voltage installations.  
Example: power feeders, counters and protection devices.
- Measurement category III corresponds to measurements on building installations.  
Example: distribution panel, circuit-breakers, machines or fixed industrial devices.
- Measurement category II corresponds to measurements taken on circuits directly connected to low-voltage installations.  
Example: power supply to electro-domestic devices and portable tools.

## PRECAUTIONS FOR USE

This device is protected against voltages not exceeding 550 V with respect to earth in measurement category III. The protection provided by the device may be compromised if it is used other than as specified by the manufacturer.

- Observe the rated Maximum voltage and the measurement category.
- Never exceed the protection limits indicated in the specifications.
- Observe the conditions of use: temperature, humidity, altitude, degree of pollution, and place of use.
- Set the switch to OFF when the device is not in use.
- Before opening the device, check that none of the terminals is connected and that the switch is set to OFF.
- Do not place your device in water.
- Do not use the device or its accessories if they seem damaged.
- Use only the accessories supplied with the device, which comply with safety standards (IEC 61010-031).
- Troubleshooting operations and metrological checks must be performed by approved skilled personnel.

# CONTENTS

<b>1. FIRST START-UP</b> .....	<b>4</b>
1.1. Unpacking.....	4
1.2. Accessories .....	4
1.3. Replacement parts .....	4
1.4. Inserting the batteries .....	5
<b>2. PRESENTATION</b> .....	<b>6</b>
2.1. Device.....	6
2.2. Functions of the device.....	7
2.3. Display unit .....	7
2.4. Keypad and button .....	8
2.5. Switch.....	11
<b>3. SIMPLE USE</b> .....	<b>12</b>
3.1. Voltage measurement.....	12
3.2. Loop measurement.....	14
3.3. Earth measurement on live circuit .....	16
3.4. Test of RCD .....	18
3.5. Direction of phase rotation.....	21
3.6. Current measurement.....	23
<b>4. USE IN DETAIL</b> .....	<b>24</b>
4.1. Before making any measurements.....	24
4.2. Voltage measurement.....	24
4.3. Compensation of the leads.....	25
4.4. Loop measurement.....	28
4.5. Earth measurement on live circuit .....	32
4.6. Test of residual current device .....	35
4.7. Direction of phase rotation.....	42
4.8. Current measurement.....	44
<b>5. SET-UP</b> .....	<b>46</b>
5.1. Access to SET-UP .....	46
5.2. Setting the date and time.....	46
5.3. Type of power supply.....	47
5.4. Audible signal .....	48
5.5. Viewing the internal parameters of the device.....	48
5.6. Smoothing of the measurement (SMOOTH) .....	48
5.7. Configuration of the measurements .....	49
5.8. Alarm thresholds.....	50
5.9. Default configuration.....	51
5.10. Communication rate for printing .....	51
<b>6. STORAGE</b> .....	<b>52</b>
6.1. Organization of the memory .....	52
6.2. Storage .....	52
6.3. Readout.....	53
6.4. Erasure .....	53
6.5. Errors.....	54
<b>7. PRINTING</b> .....	<b>55</b>
<b>8. DATA EXPORT SOFTWARE</b> .....	<b>56</b>
<b>9. TECHNICAL CHARACTERISTICS</b> .....	<b>57</b>
9.1. Reference conditions.....	57
9.2. Electrical characteristics .....	57
9.3. Variations in the range of use .....	61
9.4. Intrinsic uncertainty and operating uncertainty.....	62
9.5. Power supply.....	62
9.6. Environmental conditions .....	62
9.7. Mechanical characteristics .....	63
9.8. Conformity to international standards.....	63
9.9. Electromagnetic compatibility (EMC).....	63
<b>10. DEFINITION OF SYMBOLS</b> .....	<b>64</b>
<b>11. MAINTENANCE</b> .....	<b>65</b>
11.1. Cleaning.....	65
11.2. Replacing the batteries .....	65
11.3. Storage .....	65
11.4. Resetting the device .....	65
11.5. Updating of the internal software .....	66
<b>12. WARRANTY</b> .....	<b>67</b>

# 1. FIRST START-UP

## 1.1. UNPACKING

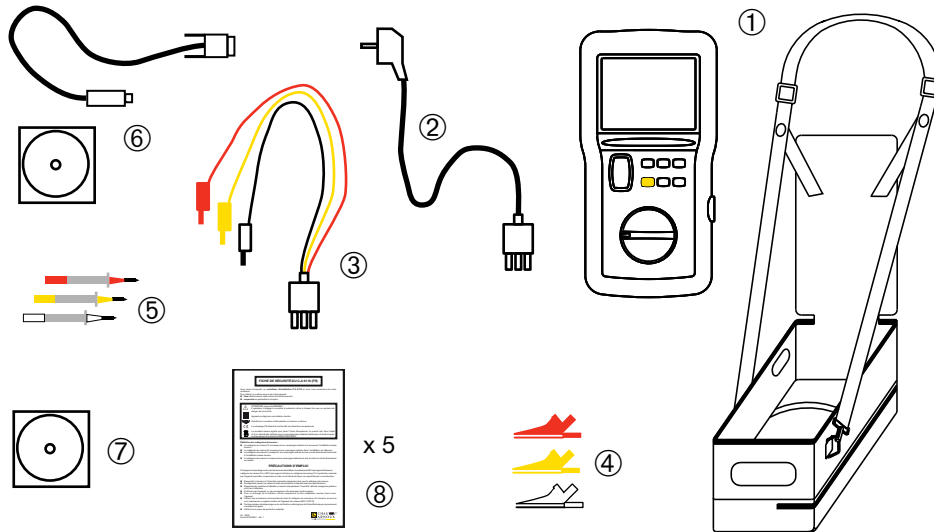

- ① A carrying bag for the device and its accessories.
- ② One mains measuring cable.
- ③ One measuring cable, three safety leads.
- ④ Three alligator clips (red, yellow and white).
- ⑤ Three probe tips (red, yellow and white).
- ⑥ Transfer software and a communication cord (optical-RS232).
- ⑦ Five user manuals (one per language) on a CD.
- ⑧ Five safety sheets (one per language).

## 1.2. ACCESSORIES

- MN20 current clamp
- C172 current clamp
- C176 current clamp
- Serial printer
- Loop kit (1 earthing rod + 1 coil of 30m of green cable)
- Earth option (Loop kit + carrying bag)

## 1.3. REPLACEMENT PARTS

- Optical communication cable
- Set of 3 alligator clips (red, yellow, white)
- Set of 3 probe tips (red, yellow, white)
- Carrying bag (for the device + its accessories)

For accessories and spare parts, visit our website:

[www.chauvin-arnoux.com](http://www.chauvin-arnoux.com)

## 1.4. INSERTING THE BATTERIES

Turn the device over.

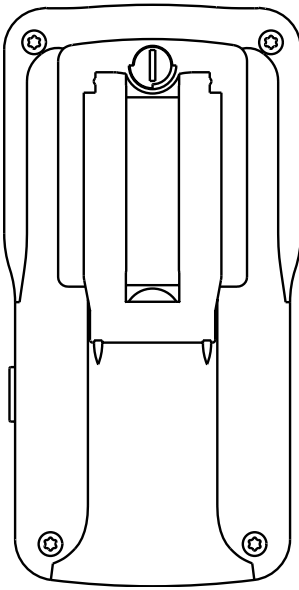

Use a coin to unscrew the quarter-turn screw of the battery compartment cover.

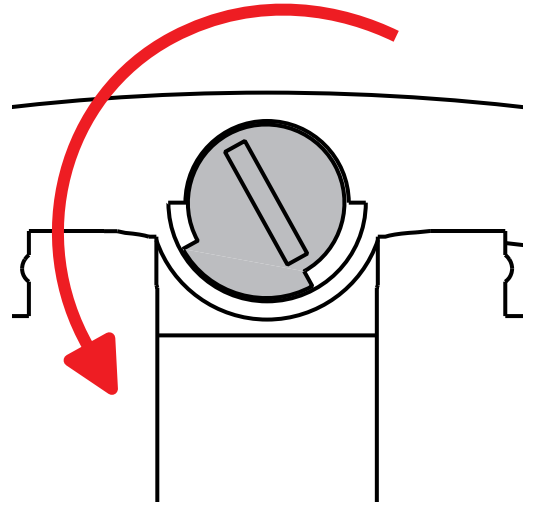

Raise the prop and pull on it to withdraw the battery compartment cover.

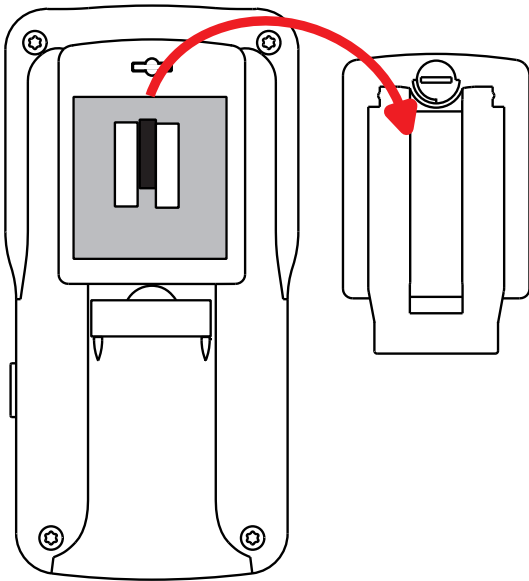

Insert the six batteries in the compartment (three to the right and three to the left), observing the indicated polarity (+ up).

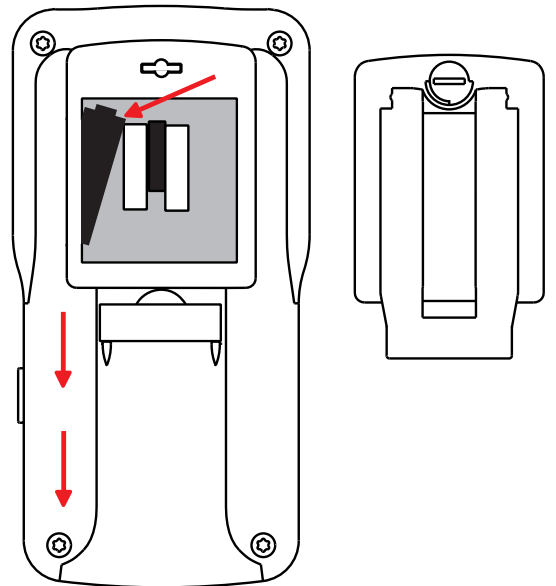

Replace the battery compartment cover and screw the quarter-turn screw back in.

## 2. PRESENTATION

### 2.1. DEVICE

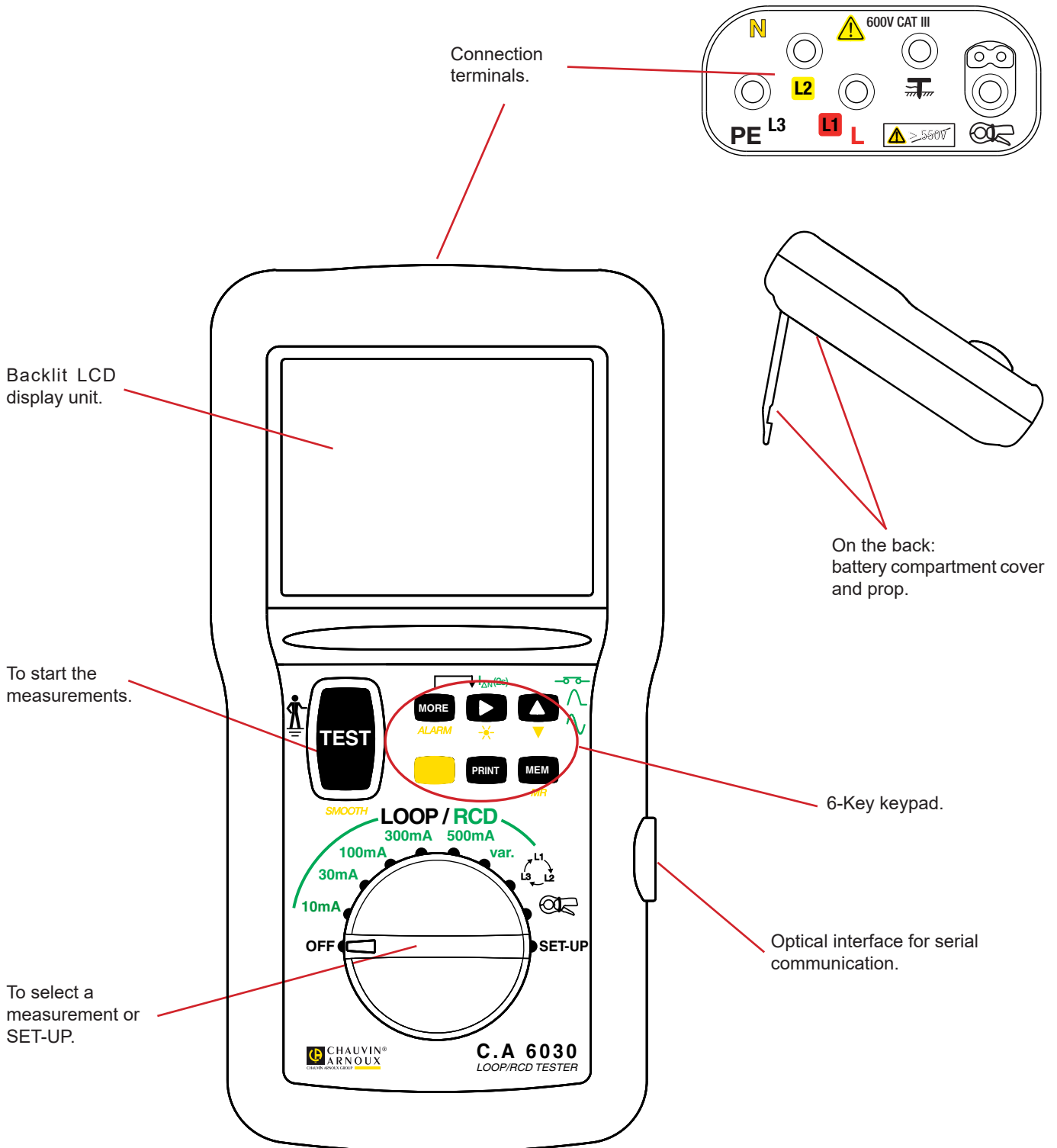

## 2.2. FUNCTIONS OF THE DEVICE

The C.A 6030 loop and RCD tester is a portable device operating on battery power. It is used to check the safety of electrical installations.

Measurement functions:

- voltage,
- frequency,
- test of the protection conductor (PE),
- fault loop measurement (L-PE),
- live earth resistance measurement ( $R_a$ ),
- line loop measurement (L-N or  $L_N-L_M$ ),
- calculation of the short-circuit current,
- test of residual current devices (RCD),
- detection of the direction of phase rotation in a three-phase network,
- current measurement with an optional current clamp.

The C.A 6030 can be very simple to use (see §3), but experienced users can also configure it manually (see §4).

## 2.3. DISPLAY UNIT

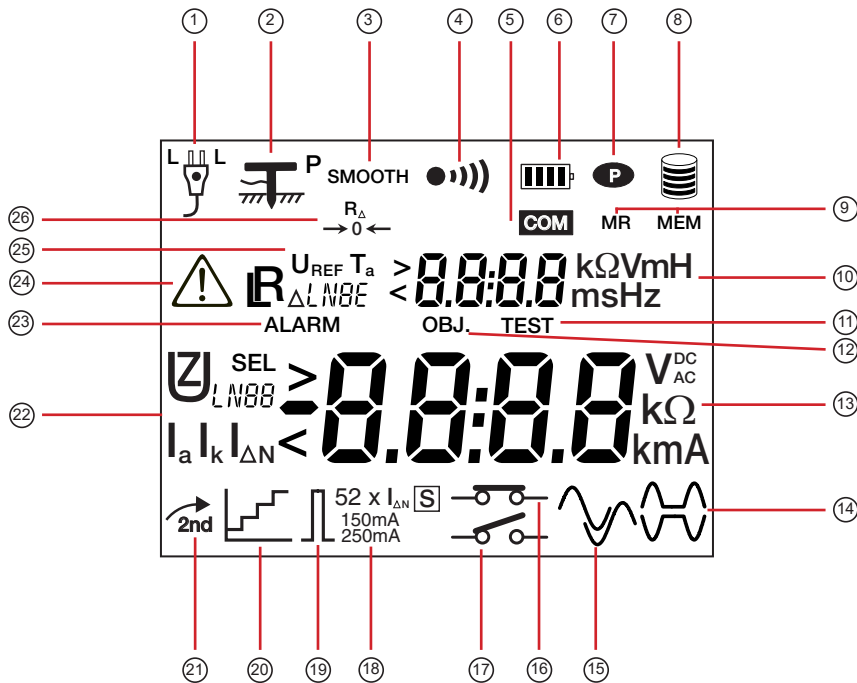

The main digital display unit and the secondary digital display unit have four digits, used to display the measurements and their various parameters.

- ① Position of the phase conductor on the outlet.
- ② Indication of connection of the auxiliary rod.
- ③ Display of the smoothed measurement.
- ④ Audible signal activated.
- ⑤ Communication via the serial link in progress.
- ⑥ Remaining battery life.
- ⑦ Automatic standby switching of the device activated.
- ⑧ Level of memory occupancy.
- ⑨ Reading or recording in memory.
- ⑩ Secondary digital display unit.
- ⑪ Test number for recording in memory.
- ⑫ Block (object) number for recording in memory.
- ⑬ Main digital display unit.
- ⑭ Half-wave signal to test the RCD (start on positive- or negative-going edge).
- ⑮ Full-wave signal to test the RCD (start on positive- or negative-going edge).
- ⑯ Measurements without tripping of the RCDs.
- ⑰ Measurements with tripping of the RCDs.
- ⑱ RCD test current in pulse mode.
- ⑲ Test of RCDs in pulse mode.
- ⑳ Test of RCDs in ramp mode.
- ㉑ Indicates a press on the yellow key (second function).
- ㉒ Type of quantity displayed.
- ㉓ Alarm function activated or display of an alarm threshold.
- ㉔ Danger symbol.
- ㉕ Type of quantity displayed.
- ㉖ Compensation of the measurement leads is activated.

In the present manual, the  symbol indicates blinking.

## 2.4. KEYPAD AND BUTTON

Presses on the keys and button are of three types:

- short press,
- press the yellow key then press the key (second function),
- long press (more than two seconds).

### 2.4.1. TEST BUTTON



- Start of a measurement, except for the voltage and current measurements, which are made immediately;
- Stop of a measurement;



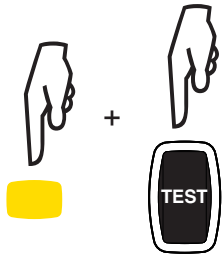

- Exit from the error mode.
- Smoothing of the measurement (SMOOTH). Activate before starting the measurement.

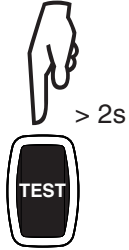

- Compensation of the measurement leads (with the rotary switch set to LOOP/RCD).

#### 2.4.2. 2ND KEY (YELLOW)

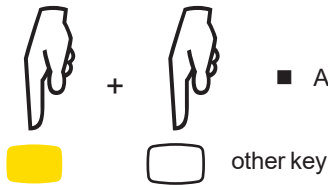

- Access to the second function of the key (marked in yellow under the key).



- Display of time and date for as long as the press lasts.

#### 2.4.3. MORE KEY



- Display of complementary measurements and/or calculations of a function, possibly in association with the ► key.

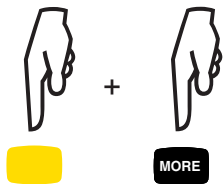

- Activation or de-activation of the alarm.  
The alarm is adjusted in SET-UP (see §5.8).

#### 2.4.4. ► KEY



- Display of the complementary measurements and/or calculations of a function, possibly in association with the MORE key.
- In memory write, memory read, or printing, selection of the block (OBJ.) or test (TEST).

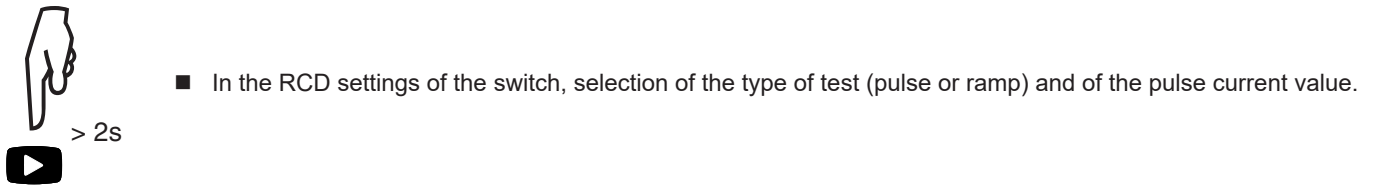
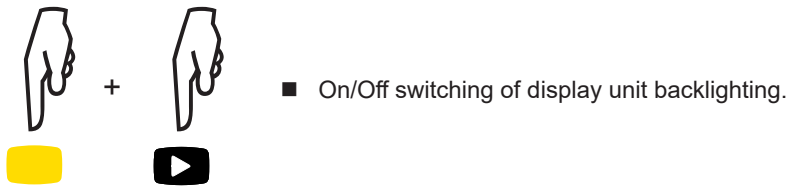

#### 2.4.5. ▲ KEY

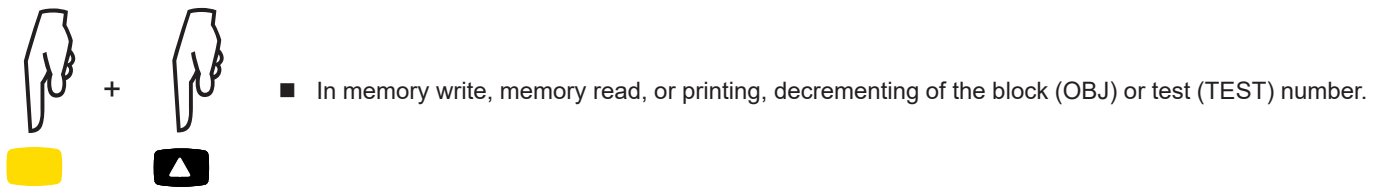
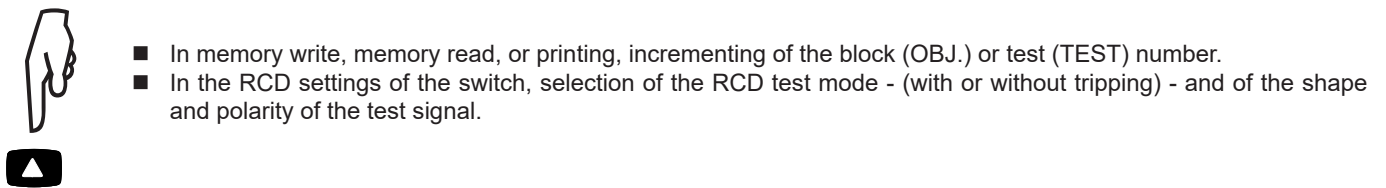

#### 2.4.6. MEM KEY

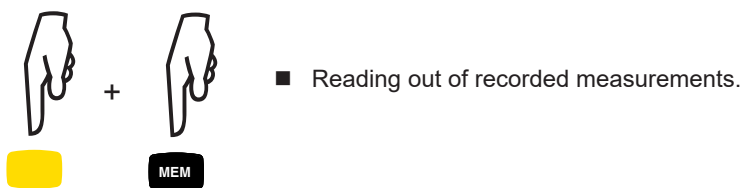
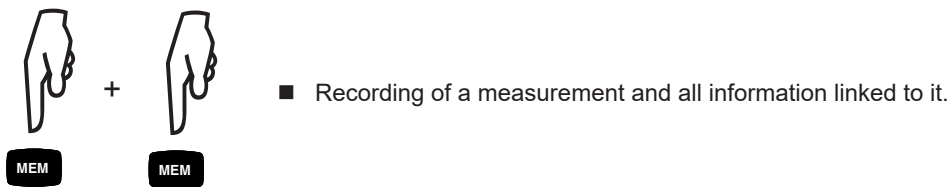

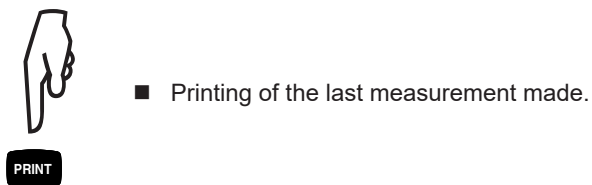

#### 2.4.7. PRINT KEY



## 2.5. SWITCH

The switch has 10 settings, used to select the desired function:

OFF	Switching the device off
LOOP / RCD 10mA, 30mA, 100mA, 300mA, 500mA	Test of RCD, rating 10, 30, 100, 300 or 500mA, or loop measurement only.
LOOP / RCD var	Test of RCD, rating 6 to 650mA (rating chosen in SET-UP).
	Determination of the phase rotation direction
	Current measurement
SET-UP	Configuration of the device

## 3. SIMPLE USE

The device is configured so that it can be used without modifying the parameters; this covers the great majority of the measurements to be made. For most measurements, you can therefore simply select the function by turning the switch, then pressing the TEST button.

However, you can also parameterize the device and the measurements using the function keys and SET-UP (see §4). If you want to record your measurement results, refer to §6.

You will find definitions of all of the abbreviations in §10.

⚠ Users are assumed to be at the reference earth potential. They must therefore not be insulated from earth: they must not wear insulating shoes or gloves and must not use a plastic object to press the TEST button.

### 3.1. VOLTAGE MEASUREMENT

#### 3.1.1. MAKING A MEASUREMENT

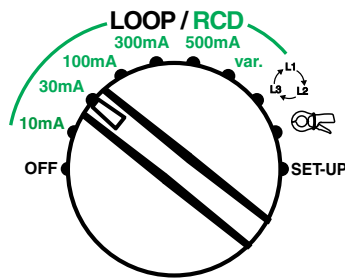

Set the switch to one of the six RCD positions.

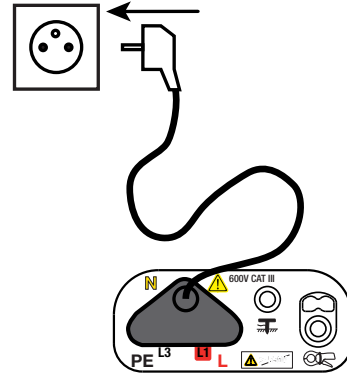

Connect one end of the lead to the terminal block of the device and the other to the device to be tested.



The mains socket outlet of the measuring cable is marked with a white reference spot. On the display unit, you will see:

-  : if the phase is on the right-hand pin of the mains plug when the white spot is up.
-  : if the phase is on the left-hand pin of the mains plug when the white spot is up.
-  : if the device cannot locate the phase, probably because the PE is not connected or the L and PE conductors are interchanged.

**Remark:** the terminal identified as L is the one that has the highest voltage with respect to PE; this does not mean that the other terminal is not at a dangerous voltage.

### 3.1.2. READING OF THE RESULT

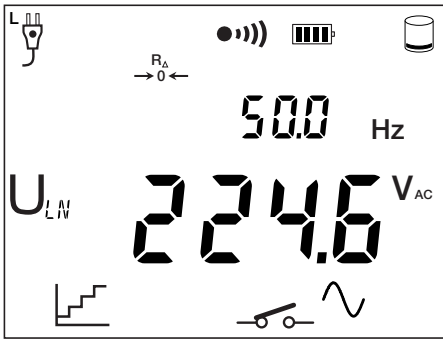

The voltage  $U_{LN}$  and its frequency are displayed.

The ► key is used to see voltages  $U_{LN}$ ,  $U_{LPE}$  and  $U_{NPE}$  and their frequencies.

### 3.1.3. ERROR INDICATION

The only errors reported in voltage measurement are values outside the voltage and/or frequency measurement range.

To exit from the error mode, you must eliminate the cause of the error.

### 3.2. LOOP MEASUREMENT

The loop measurement is used to measure the earth resistance at a place where it is impossible to make a 3P earth measurement or to disconnect the earthing strip, a common situation in urban settings.

The loop measurement does not trip RCDs located upstream of the measurement point.

In a TT type installation, the loop impedance measurement is an easy way to make an earth measurement without planting any rods. The result obtained,  $R_{LPE}$ , is the loop resistance of the installation between the L and PE conductors. It is only very slightly greater than the earth resistance, to which it adds the earthing resistance of the transformer and the resistance of the cables, which are both negligible.

In a TN or TT installation, the loop resistance measurement can also be used to calculate the short-circuit current and to size the protections of the installation (fuse or circuit-breaker)

The loop measurement cannot be made in an IT installation because of the high earthing impedance of the power supply transformer, even its total isolation from earth.

#### 3.2.1. MAKING A MEASUREMENT

Set the switch to one of the LOOP/RCD positions.

Connect the measuring cable to the device, then to the socket outlet of the installation to be tested.

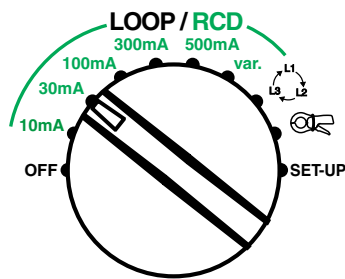

We recommend first disconnecting all loads from the network on which you make the loop measurement.

This guarantees non-tripping of upstream RCDs, by eliminating any residual current there might be in the installation.

If, in spite of all, tripping occurs, refer to §5.7.4, which explains how to reduce the test current.

Case of a TT installation

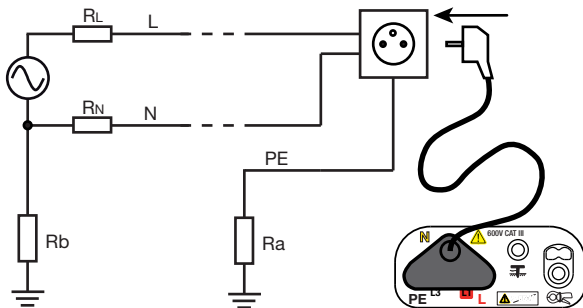

Case of a TN installation

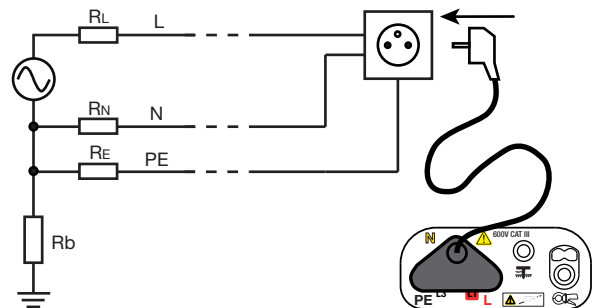

To set the device to non-tripping mode, press the ▲ key until the  symbol is displayed.

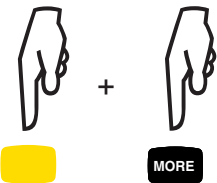

To activate the alarm, press the ALARM key. The device will emit an audible signal if the measurement result exceeds 50 Ω (default value; can be programmed in SET-UP).



Press the TEST button to start the measurement. The measurement stops automatically.



### 3.2.2. READING OF THE RESULT

During the measurement, the device displays "LOOP" and the dashes blink.

At the end of the measurement, the device displays the following screen:

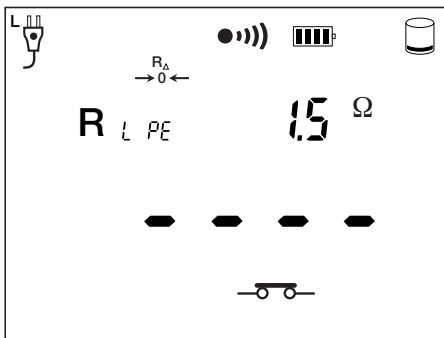

The measurement result,  $R_{LPE}$ , is the loop resistance.  
If the switch is set to 300 or 500mA, the loop impedance,  $Z_{LPE}$ , is also displayed.

Press the MORE key to view the other result screens.



MORE

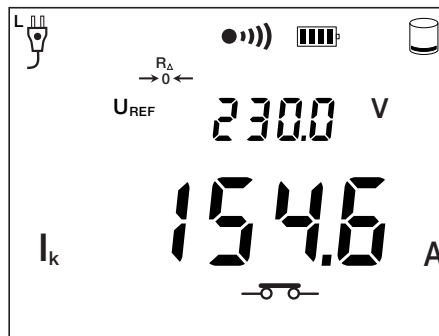

$I_k$  is the short-circuit current:  
 $I_k = U_{REF} / R_{LPE}$

As default,  $U_{REF} = 230$  V.

There are two other result screens. The  $\blacktriangleright$  key is used to view voltages  $U_{LN}$ ,  $U_{LPE}$  and  $U_{NPE}$  and the compensation resistances of the leads  $R_{\Delta L}$ ,  $R_{\Delta PE}$  and  $R_{\Delta N}$ .

### 3.2.3. ERROR INDICATION

The commonest errors in the case of loop resistance measurement:

- A connection error.
- Voltage on the protection conductor too high.

Check your connections carefully, then repeat the measurement.

To exit from the error mode, press the TEST button.

### 3.3. EARTH MEASUREMENT ON LIVE CIRCUIT

This measurement is made without disconnecting the earth, with only one additional rod, saving time with respect to a conventional earth measurement with two auxiliary rods.

In the case of a TT installation, this measurement is a very simple way to measure the earth of frame grounds.

The live earth measurement cannot be made in an IT installation because of the high earthing impedance of the power supply transformer, even its total isolation from earth.

#### 3.3.1. MAKING A MEASUREMENT

Set the switch to one of the RCD positions.

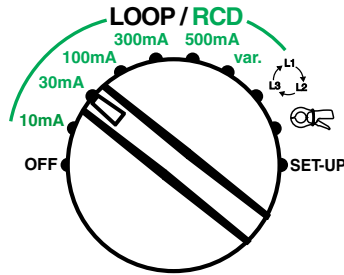

Connect the measuring cable to the device, then to the socket outlet of the installation to be tested.

We recommend first disconnecting all loads from the network on which you make the live earth measurement.

Plant the auxiliary rod at a distance of more than 25 metres from the earth electrode and connect it to the terminal of the device. The symbol is then displayed.

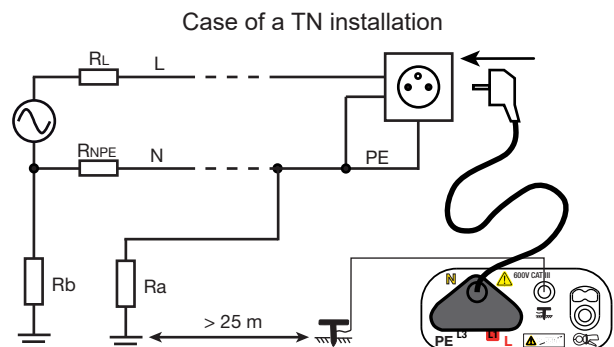
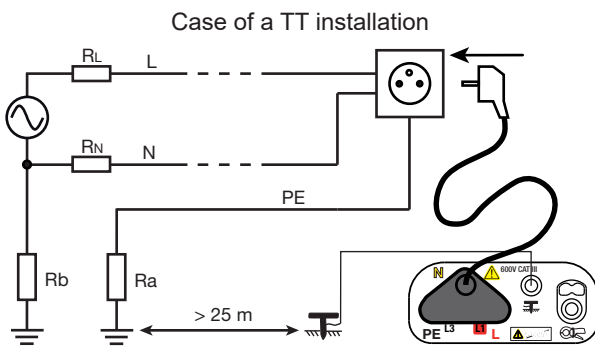

To set the device to non-tripping mode, press the ▲ key until the symbol is displayed.



+



To activate the alarm, press the ALARM key. The device will emit an audible signal if the measurement result exceeds 50 Ω (default value; can be programmed in SET-UP).



Press the TEST button to start the measurement. The measurement stops automatically.





### 3.3.2. READING OF THE RESULT

During the measurement, the device displays “-rA-” and the dashes blink.

At the end of the measurement, the device displays the following screen:

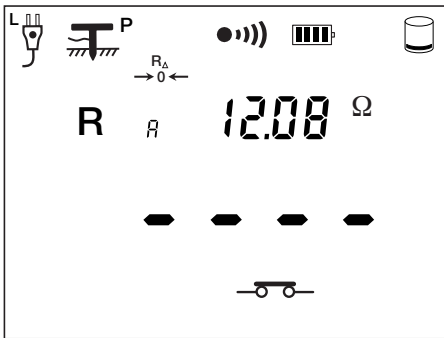

The earth resistance,  $R_A$ , is the measurement result.

### 3.3.3. ERROR INDICATION

The commonest errors in the case of a live earth measurement:

- A connection error.
- A voltage on the protective conductor that is too high.
- An earth rod resistance that is too high: reduce it by tamping and moistening the earth around the rod.
- A voltage on the rod that is high: move the rod away from the influence of the earth electrode.

To exit from the error mode, press the TEST button.

### 3.4. TEST OF RCD

The device can perform two types of test on RCDs:

- a test of tripping in ramp mode,
- a test of tripping in pulse mode.

The test in ramp mode serves to determine the current at which the RCD trips.  
 The test in pulse mode serves to determine how long it takes for the RCD to trip.

#### 3.4.1. PERFORMING A TEST

Set the switch to the RCD position that corresponds to the rated current of the RCD to be tested.

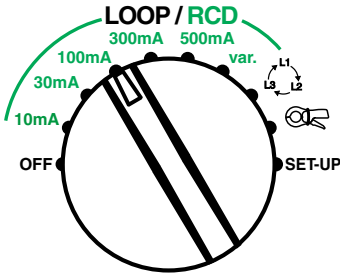

Connect the three-conductor cord to the device, then plug it into an outlet in the circuit protected by the RCD to be tested.

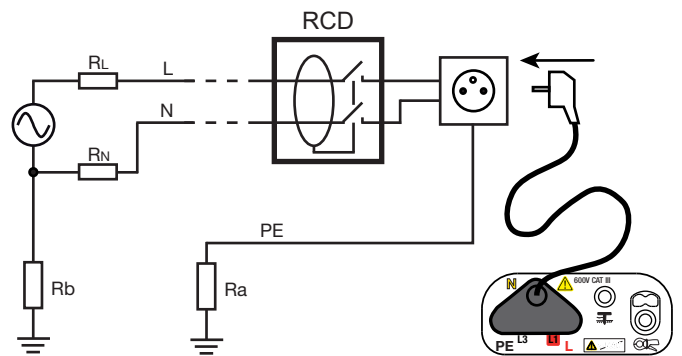

For a more accurate measurement in ramp mode, we recommend first disconnecting all loads from the network on which you are performing the test, in order to eliminate any residual currents in the installation.

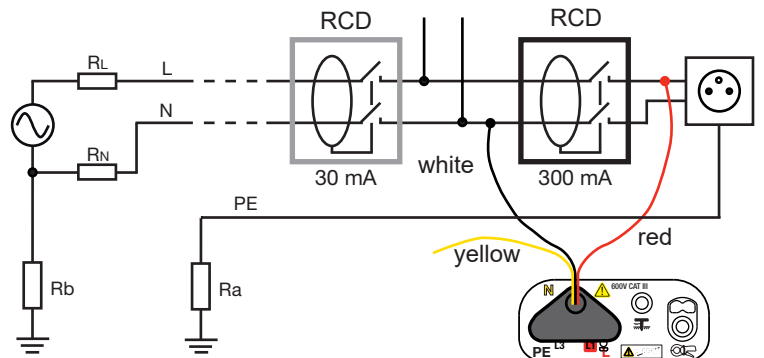

#### Particular case:

To test an RCD located downstream of another RCD having a smaller nominal current, you must use the three-conductor cord terminated by 3 leads and make the connections shown opposite (upstream-downstream method). In this case, the RCD tested is not part of the installation.



- Check that you are in fact in tripping mode (  symbol displayed). If not, press the ▲ key until the  symbol is displayed.







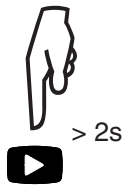

- Then choose the type of test (if the tripping mode  is not selected, it is not possible to choose the type of test):

Perform a long press on the ► key.

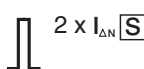

Each time the ► key is pressed again, the device proposes a type of test:

-  test in ramp mode
-  test in pulse mode
-  test in Pulse mode at  $2I_{\Delta N}$  for the type S RCD
-  test in Pulse mode at  $5I_{\Delta N}$
-  test in Pulse mode at 150mA
-  test in Pulse mode at 250mA

The test signal shape proposed is sinusoidal starting with a positive-going edge. This suits most of the tests. It is however possible to change it (see §4.6).

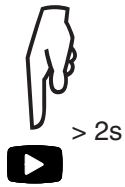

To validate your choice, perform another long press on the ► key.

- To activate the alarm, press the ALARM key. The device will emit an audible signal if the measurement result exceeds 50 Ω (default value; can be programmed in SET-UP).

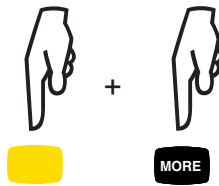

Press the TEST button to start the measurement. The measurement stops automatically.

The device first of all performs a loop measurement to check that the fault voltage,  $U_F$ , will not exceed maximum voltage  $U_L$  during the tripping test. If this is the case, the tripping measurement is disabled. Again, during the tripping test, voltage  $U_F$  is monitored. If it exceeds  $U_L$ , the test is aborted.

This precaution ensures that the measurement made will not endanger the installation.

### 3.4.2. READING OF THE RESULT

During the measurement, the device starts by displaying “LOOP” during the preliminary measurement; during the test of the RCD, it displays “rCd” and the dashes blink.

A  $\square$  (selective) RCD is normally tested at  $2 I_{\Delta N}$ . The device counts 30 seconds between the preliminary measurement and the test of the RCD proper, in order to allow its demagnetization, and displays “SEC”. This wait can be cut short by pressing the TEST button again.

The results are presented in the same way in the ramp mode as in the pulse mode, with or without an auxiliary rod.

At the end of the measurement, the device displays the following screen:

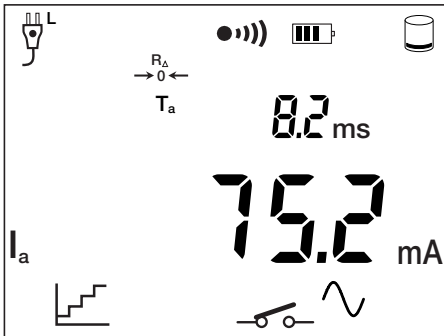

In the ramp mode, the current  $I_a$  at which the RCD tripped.  $I_a$  must be between  $0.5 I_{\Delta N}$  and  $I_{\Delta N}$ .

In the pulse mode, the tripping time  $T_a$ . It must be less than 300 ms (200 ms for a selective RCD).

### 3.4.3. ERROR INDICATION

The commonest errors in the case of an RCD test are:

- A connection error.
- The fault voltage is too high and, for the user's safety, the test was aborted. It is necessary in this case to revise the wiring of the installation and to measure the earth with an earth ohmmeter.
- An earth rod resistance that is too high: reduce it by tamping and dampening the earth around the rod.
- The circuit-breaker trips out when it should not. The leakage currents are probably too high. First disconnect all loads from the network on which you are performing the test. Also perform a second test with current  $I_{tP}$  reduced in SET-UP (see §5.7.4). If the problem persists, the RCD must be declared defective.
- The RCD failed to trip in the ramp mode test. But, to ensure the users' safety, the RCD must trip at a current between  $I_{\Delta N}/2$  and  $I_{\Delta N}$ . Check the wiring of the RCD. If there is nothing wrong with it, the RCD must be declared defective and replaced.
- The RCD failed to trip in the test in pulse mode. Check the wiring of the RCD. If there is nothing wrong with it, the RCD must be declared defective and replaced.
- The device is too hot. Wait until it cools before resuming the measurements.

To exit from the error mode, press the TEST button.

### 3.5. DIRECTION OF PHASE ROTATION

This measurement is made on a three-phase network. It is used to check the phase order of the network. This can be done by the “3-wire” method or by the “2-wire” method.

#### 3.5.1. MAKING A “3-WIRE” MEASUREMENT

Set the switch to .

Connect the measuring cable terminated by 3 leads to the device and to each of the phases: the red lead to L1, the yellow to L2 and the white to L3.

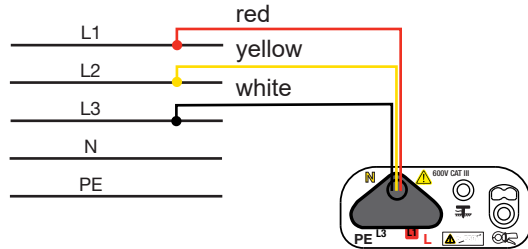
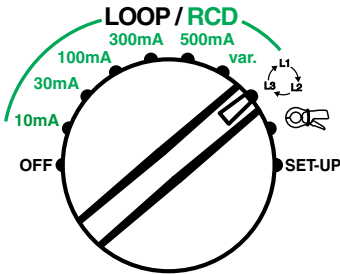

Press the TEST button to start the measurement. The measurement stops automatically.

#### 3.5.2. MAKING A “2-WIRE” MEASUREMENT

Set the switch to .

Press the  key to switch to “2-wire” measurement. The “rdy 3L” display becomes “rdy 2L”.

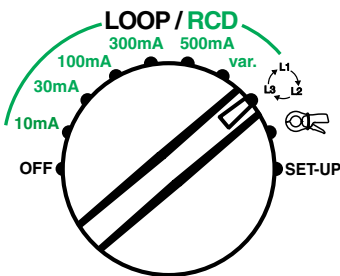

Connect the three-conductor cord terminated by 3 leads to the device and connect the yellow lead to L2.

Press the TEST button.

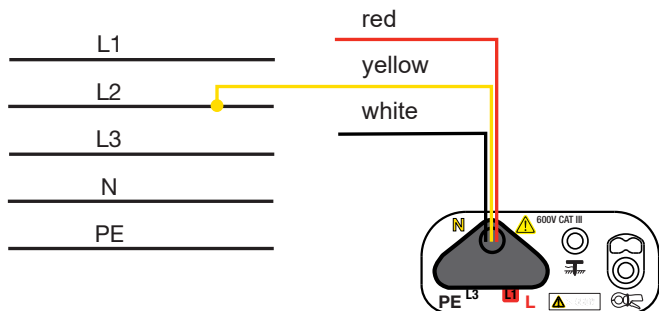

Wait for the message “to L1” on the display unit, then connect the red lead to L1.

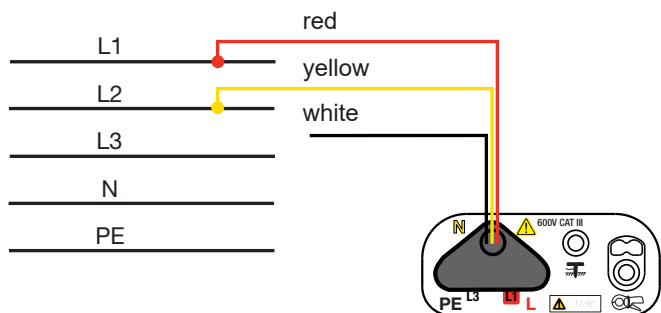

Wait for the message “open L1” to appear on the display unit and disconnect the red lead. When the message “to L3” is displayed, connect the red lead to L3.

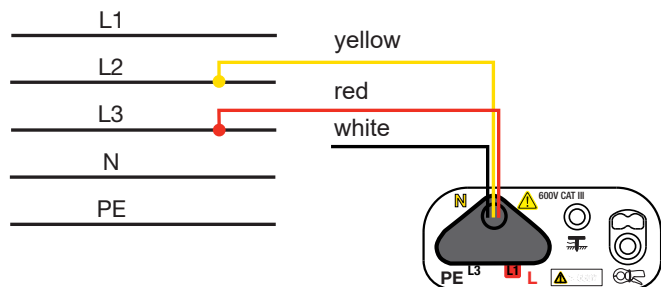

The measurement is over and the result is displayed.

### 3.5.3. READING OF THE RESULT



1.2.3: the phase order is direct.  
 3.2.1: the phase order is reversed.

### 3.5.4. ERROR INDICATION

The commonest errors in the case of a test of direction of phase rotation are:

- One of the three voltages is outside the measurement range (connection error).
- The frequency is outside the measurement range.

To exit from the error mode, press the TEST button.

### 3.6. CURRENT MEASUREMENT

This measurement requires the use of an optional current clamp.

It can measure very low currents (of the order of a few mA) like leakage currents, and high currents (of the order of a few hundred Amperes).

#### 3.6.1. MAKING A MEASUREMENT

Set the switch to .

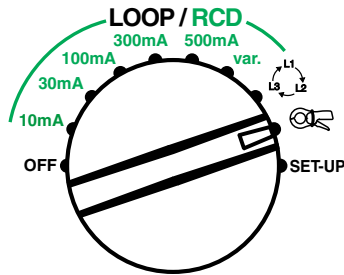

Connect the clamp to the  terminal of the device. Press the trigger to open the clamp and close it on the conductor to be measured. Release the trigger. To activate the alarm, press the ALARM key. The device will emit an audible

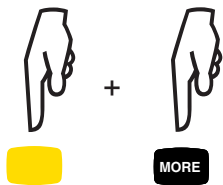
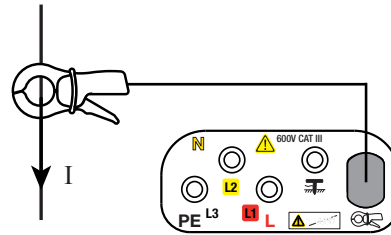

signal if the measurement result exceeds 30mA (default value; can be programmed in SET-UP). There is no need to press the TEST button because the measurement is made at all times.

#### 3.6.2. READING OF THE RESULT

The measured current and its frequency.

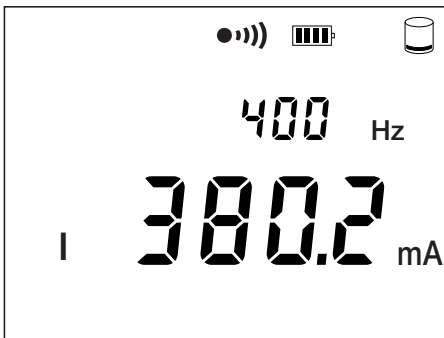

If the L, N, and PE terminals are connected, it is also possible to read the values  $U_{LN}$ ,  $U_{LPE}$  and  $U_{NPE}$  using the MORE and  keys.

#### 3.6.3. ERROR INDICATION

The commonest errors in the case of a current measurement are:

- The clamp is not connected.
- The current or frequency is outside the measurement range.



To exit from the error mode, you must eliminate the cause of the error.

## 4. USE IN DETAIL

In this part, all functions of the device are described, together with the measurement principles. You can parameterize the measurements using the function keys or by configuring the device in SET-UP (§5).

 Users are assumed to be at the reference earth potential. They must therefore not be insulated from the earth: they must not wear insulating shoes or gloves and must not use a plastic object to press the TEST button.

### 4.1. BEFORE MAKING ANY MEASUREMENTS

- If you want to record your measurement results, make sure that the date and time of the device are correct (see §5.2).
- Also make sure that the device has enough free memory. The  symbol indicates the level of memory occupancy, with each bar representing 50 measurements recorded. The total capacity is 200 measurements. If the memory is full, refer to §6.4 for an explanation of how to erase it, partially or completely.
- Before starting a measurement by pressing the TEST key, check that the configuration of the device suits your application. This can be done by successive presses on the MORE key and the  key.

### 4.2. VOLTAGE MEASUREMENT

#### 4.2.1. DESCRIPTION OF THE MEASUREMENT PRINCIPLE

In all of the LOOP/RCD settings, the device is a voltmeter that measures the voltages present on its terminals at all times.

The device separates the alternating voltage from the direct voltage and compares the amplitudes to decide whether the signal is AC or DC. In the case of an AC signal, the frequency is measured and the device calculates the RMS value of the AC part and displays it. In the case of a DC signal, the device does not measure its frequency, but calculates its mean value and displays it.

The device checks that the connection is correct and displays the position of the phase on the outlet. It also checks the presence of a protection conductor on the PE terminal thanks to the contact users make by touching the TEST button with a finger (the key conducts).

#### 4.2.2. MAKING A MEASUREMENT

Refer to §3.1.1.

#### 4.2.3. ERROR INDICATION

The only errors reported in voltage measurement are:

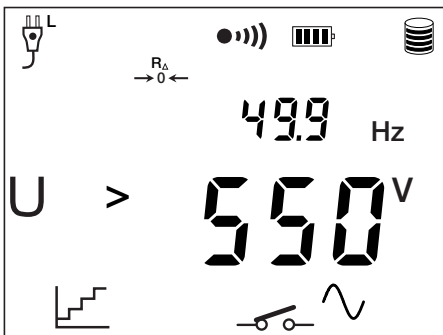

voltage outside measurement range,



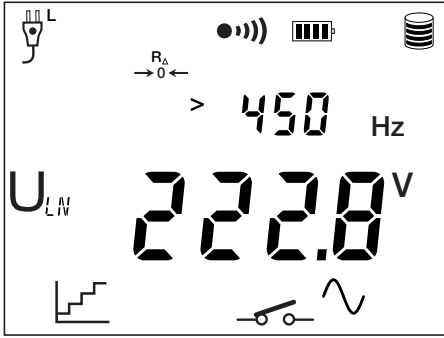

frequency outside measurement range,

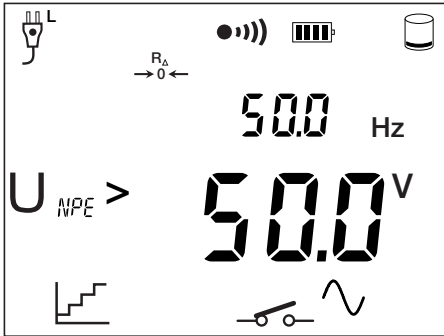

or a connection error.

To exit from the error mode, you must eliminate the cause of the error. Here, this is done by connecting the device to a network of which the voltage and frequency are compatible with the specifications of the device (see §9.2.1 and 9.2.2).

### 4.3. COMPENSATION OF THE LEADS

The leads must be compensated for measurements of low loop and earth resistance values, in order to make the measurements more accurate.

If a compensation already exists, the  $\rightarrow 0 \leftarrow$  symbol is displayed. To view the compensation values, use the MORE and ► keys.

#### 4.3.1. APPLYING A COMPENSATION

Set the switch to one of the LOOP/RCD positions.

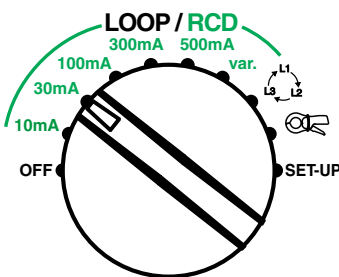

Connect one end of the three-conductor cord terminated by 3 leads to the device. Short-circuit the 3 leads.

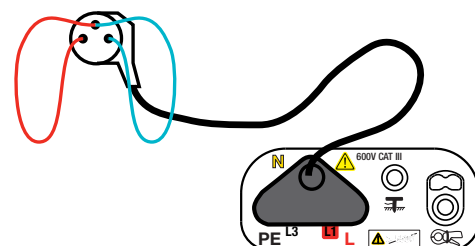
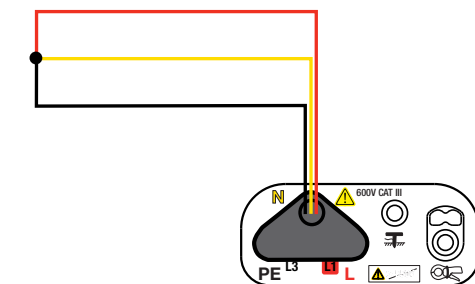

In the case of a mains outlet, connect the two earth pins with the earth pins with leads.

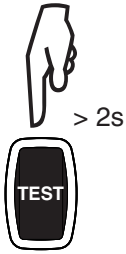

Perform a long press on the TEST button.

During the measurement, the device displays "LEAd" and the  $\rightarrow 0 \leftarrow$  symbol, and the dashes blink.

At the end of the measurement, the device displays the following screen:

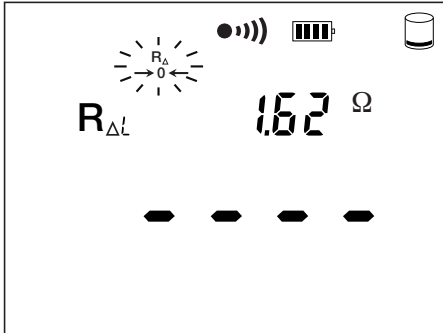

The  $\blacktriangleright$  key is used to view the values of  $R_{\Delta L}$ ,  $R_{\Delta N}$  and  $R_{\Delta PE}$ .

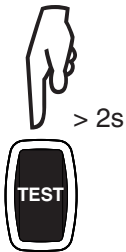

To exit from compensation of the leads, perform a second long press on the TEST key.

If the compensation of the leads is effective, the  $\rightarrow 0 \leftarrow$  symbol is lit steadily.  
If the compensation has not been performed, the symbol is not displayed and the compensation values are zero.

#### 4.3.2. WITHDRAW A COMPENSATION

Set the switch to one of the LOOP/ RCD positions.

To withdraw the compensation of the leads, connect nothing to the terminals, or leave the leads open.

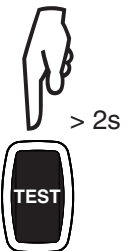
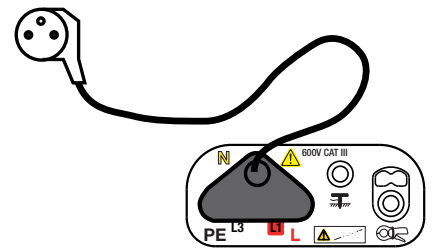
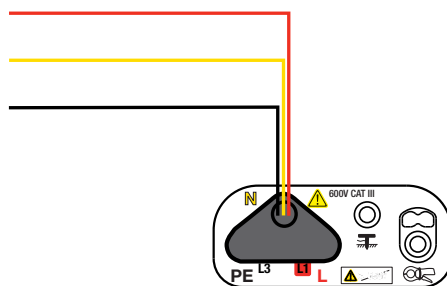
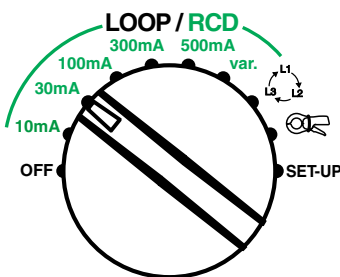

Then perform a long press on the TEST button.

During the measurement, the device displays "LEAd" and the  $\rightarrow 0 \leftarrow$  symbol and the dashes blink.

At the end of the measurement, the device displays the following screen:

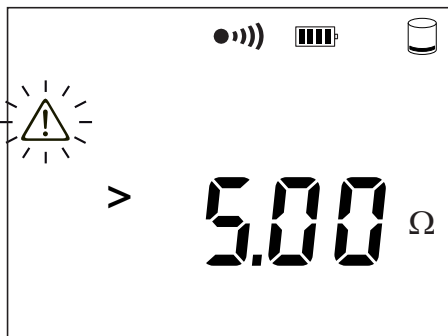

The device reports that the result found is greater than 5 Ω and withdraws the compensation of the leads.

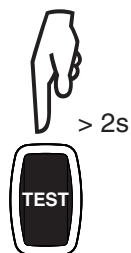

For exit from compensation of the leads, perform a second long press on the TEST key.

#### 4.3.3. ERROR INDICATION

The errors that can occur during the compensation of the leads are:

- The voltage on the terminals exceeds 2 V. Check your connections.

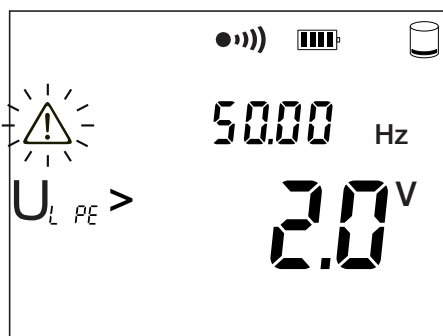

- The measured resistance of the leads is greater than 5 Ω. If this is not intentional, to withdraw the compensation, check your connections.

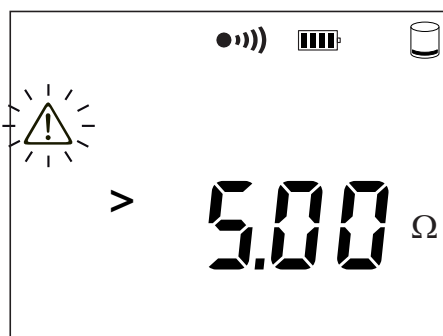

## 4.4. LOOP MEASUREMENT

### 4.4.1. DESCRIPTION OF THE MEASUREMENT PRINCIPLE

The device injects an adjustable measurement current,  $INtP = I_{\Delta N} \times (0.1 \text{ to } 0.5)$ , chosen by the user, between L and PE. This weak current serves to avoid tripping the RCD of which the nominal current is indicated on the switch.

The device thereby measures  $R_{LPE}$  and  $Z_{LPE}$  if  $INtP \geq 100\text{mA}$ . If a rod is planted, it also measures  $R_A$  ( $Z_A$  if  $INtP \geq 100\text{mA}$ ).

The device then calculates the short-circuit current  $I_k = U_{REF} / Z_{LPE}$ .

The value of  $I_k$  serves to check the proper sizing of the protections.

### 4.4.2. MAKING A MEASUREMENT

For the connection diagrams, refer to §3.2.1.

Before starting the measurement, you can parameterize it:

- By adjusting the alarm.  
As default, the device indicates whether the measurement exceeds  $50 \Omega$ , but this value can be programmed in SET-UP (see §5.8).
- By choosing the value of  $U_{REF}$  that will be used to calculate the short-circuit current (see §5.7.1).
- By choosing the maximum contact voltage,  $U_L$  (see §5.7.2).
- By choosing the nominal current of the RCD  $I_{\Delta N}$ . This current is determined by the setting of the switch: 10, 30, 100, 300, 500mA, or VAR.  
The VAR. setting is used to choose a current of 6 to 650mA (see §5.7.3).
- By choosing non-tripping measurement current  $INtP$  (see §5.7.4).  
If the RCD operates normally and no load is connected downstream, choose  $INtP = 0.4$  or  $0.5 I_{\Delta N}$ , which avoids tripping and gives better resolution and accuracy in the loop measurement.

If it is not possible to disconnect the loads downstream of the RCD, choose  $INtP = 0.2$  or  $0.3 I_{\Delta N}$  to tolerate the presence of leakage currents during the measurement and avoid tripping.

For greater security as regards non-tripping, you can measure, in advance, the leakage current (see §3.6 or §4.8) circulating in the RCD before choosing  $INtP$ . Bearing in mind that:  
 $I_{leak} + INtP$  must be less than  $0.5 I_{\Delta N}$ .

- By choosing the number of measurements to be taken into account for smoothing of the measurement (SMOOTH) (see §5.6).
- By choosing whether or not to compensate the leads (see §4.3).
- By activating the alarm.

Set the switch to the RCD position corresponding to the rated current of the RCD that protects the installation.

To activate the alarm, press the ALARM key. The device will indicate whether the measurement result crosses the programmed threshold.

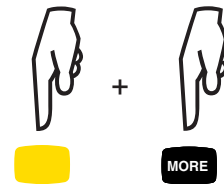
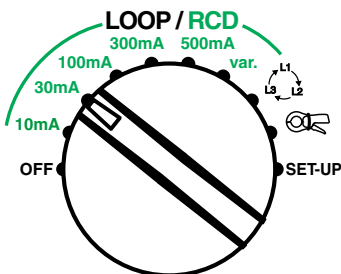

- By activating smoothing of the measurement (SMOOTH).

Without turning the switch, press the SMOOTH key.

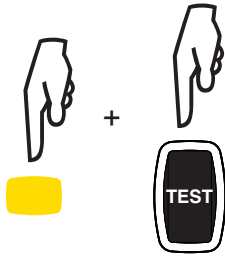

- To set the device to non-tripping mode, press the ▲ key until the  symbol is displayed



Press the TEST button to start the measurement. The measurement stops automatically.

#### 4.4.3. READING OF THE RESULT

During the measurement, the device displays «LOOP» and the dashes blink.

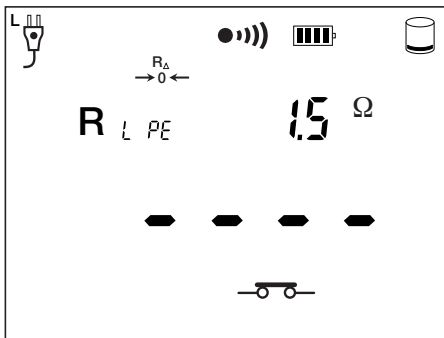

At the end of the measurement, the device displays the following screen:

The measurement result, RLPE, is the loop resistance.

If current  $INTp \geq 100mA$ , loop impedance,  $Z_{LPE}$ , is also displayed.

To have  $INTp \geq 100mA$ , you must operate in the 300mA, 500mA, or VAR range ( $\geq 300mA$ ).

Press the MORE key to view the other result screens.

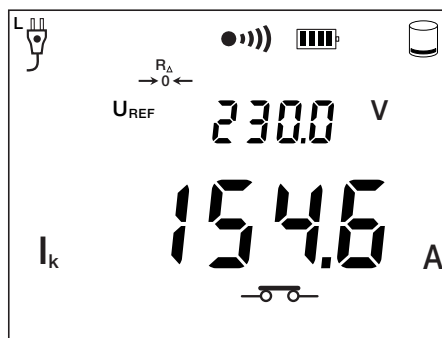

$I_k$  is the short-circuit current:  
 $I_k = U_{REF} / R_{LPE}$

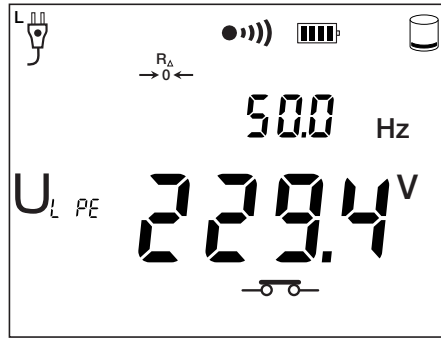

Voltage  $U_{LPE}$  and its frequency before the start of the measurement.

The ► key is used to view voltages  $U_{LN}$ ,  $U_{NPE}$  and  $U_{LPE}$ .

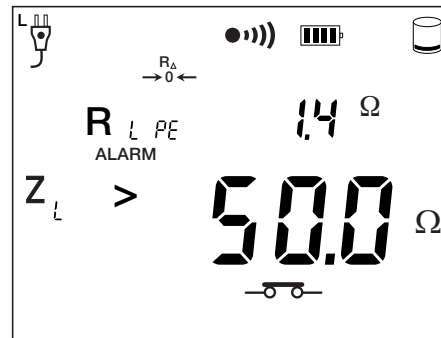

Alarm threshold,  $Z_L$ , has not been crossed.

#### 4.4.4. ERROR INDICATION

The commonest errors in the case of a loop resistance measurement are:

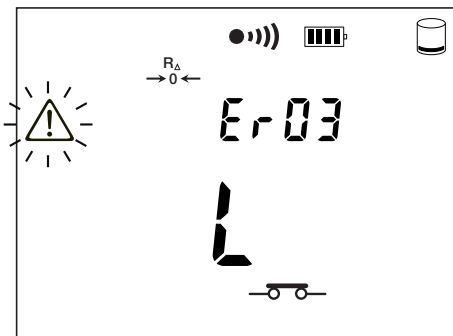

A connection error, for example no voltage on L,

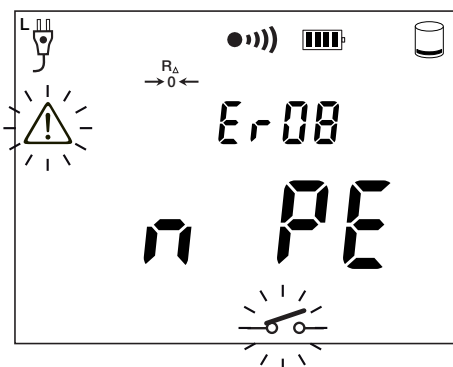

or N and PE reversed,

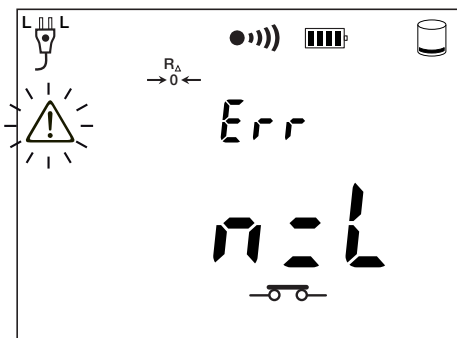

or L and PE reversed.

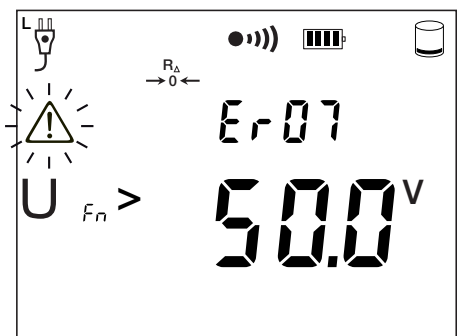

Voltage on the protection conductor too high.  
Then check the earth resistance.



To exit from the error mode, press the TEST button.

## 4.5. EARTH MEASUREMENT ON LIVE CIRCUIT

This measurement is made without disconnecting the earth, with only one additional rod, saving time with respect to a conventional earth measurement with two auxiliary rods.

In the case of a TT type installation, this measurement is a very simple way to measure the earth of frame grounds.

This measurement cannot be made in an IT installation because of the high earthing impedance of the power supply transformer, even its total isolation from earth.

### 4.5.1. DESCRIPTION OF THE MEASUREMENT PRINCIPLE

The device starts by making a loop measurement  $R_{LPE}$ . It then measures the potential between the PE conductor and the auxiliary rod and from it deduces the value of the earth measurement,  $R_A = U_{PI-PE} / INtP$ ,  $INtP$  being the measurement current chosen by the user.

### 4.5.2. MAKING A MEASUREMENT

For the connection diagrams, refer to §3.3.1.

Before starting the measurement, you can parameterize it:

- By adjusting the alarm.  
As default, the device indicates whether the measurement exceeds 50 Ω, but this value can be programmed in SET-UP (see §5.8).
- By choosing the value of  $U_{REF}$  that will be used to calculate the short-circuit current (see §5.7.1).
- By choosing the maximum contact voltage,  $U_L$  (see §5.7.2).
- By choosing the nominal current of the RCD  $I_{ΔN}$ . This current is determined by the setting of the switch: 10, 30, 100, 300, 500mA, or VAR.  
The VAR. setting is used to choose a current of 6 to 650mA (see §5.7.3).
- By choosing non-tripping measurement current  $INtP$  (see §5.7.4).  
If the RCD operates normally and no load is connected downstream, choose  $INtP = 0.4$  or  $0.5 I_{ΔN}$ , which avoids tripping and gives better resolution and accuracy in the loop measurement.

If it is not possible to disconnect the loads downstream of the RCD, choose  $INtP = 0.2$  or  $0.3 I_{ΔN}$  to tolerate the presence of leakage currents during the measurement and avoid tripping.

For greater security as regards non-tripping, you can measure, in advance, the leakage current (see §3.6 or §4.8) circulating in the RCD before choosing  $INtP$ . Bearing in mind that:  
 $I_{leak} + INtP$  must be less than  $0.5 I_{ΔN}$ .

- By choosing the number of measurements to be taken into account for smoothing of the measurement (SMOOTH) (see §5.6).
- By choosing whether or not to compensate the leads (see §4.3).
- By activating the alarm.

Set the switch to the RCD position corresponding to the rated current of the RCD that protects the installation.

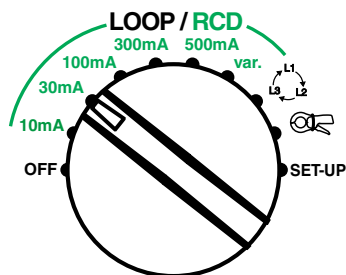

To activate the alarm, press the ALARM key. The device will indicate whether the measurement result crosses the programmed threshold.

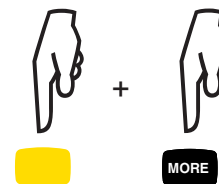



- By activating smoothing of the measurement (SMOOTH).

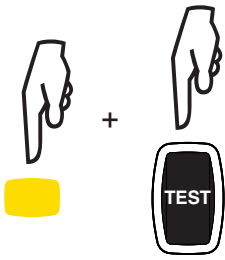

Without turning the switch, press the SMOOTH key.

- To set the device to non-tripping mode, press the ▲ key until the  symbol is displayed.



Press the TEST button to start the measurement. The measurement stops automatically

#### 4.5.3. READING OF THE RESULT

During the measurement, the device displays “-rA-” and the dashes blink.

At the end of the measurement, the device displays the following screen:

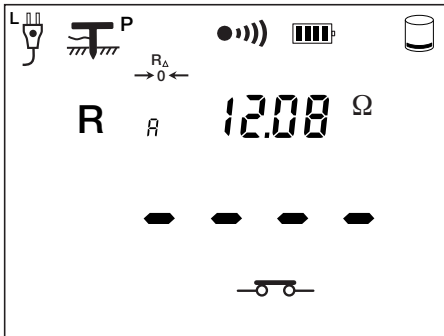

The earth resistance,  $R_A$ , is the result of the measurement.

Press the MORE key to see the other result screens.

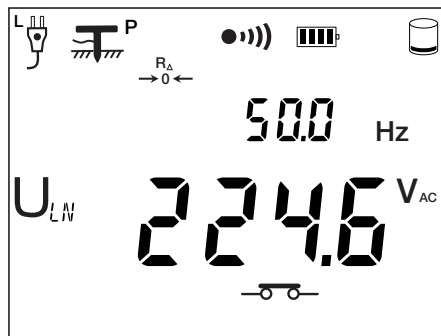

Voltage  $U_{LN}$  and its frequency before the start of the measurement.

The ► key is used to view the voltages  $U_{NPE}$ ,  $U_{LPE}$ ,  $U_P$  (voltage on the rod) and  $U_{LN}$ .

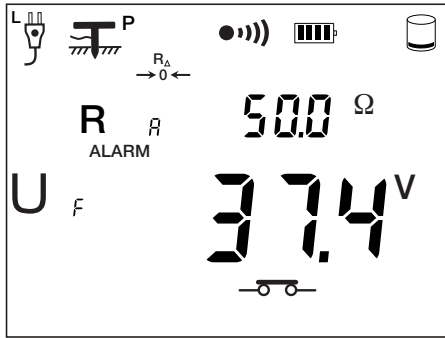

The alarm threshold,  $R_{ALARM}$  and the fault voltage:  
 $U_F = U_{REF} \times R_A / R_{LPE}$

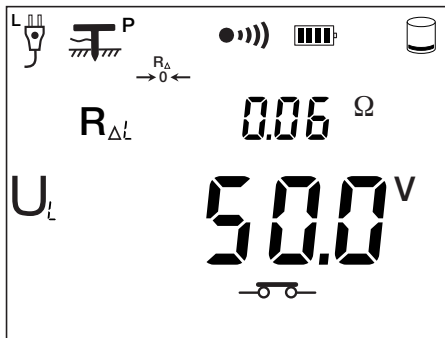

The compensation of the L lead. The ► key is used to view the compensation of the N and PE leads ( $R_{ΔN}$  and  $R_{ΔPE}$ ) along with the resistance of the rod ( $R_p$ ). The conventional maximum contact voltage is displayed at the bottom.

#### 4.5.4. ERROR INDICATION

The commonest errors in the case of a live earth measurement:

- A connection error (see §4.4.4).
- The voltage on the protection conductor is too high (see §4.4.4).

- An earth rod resistance is too high: reduce it by tamping and dampening the earth around the rod.

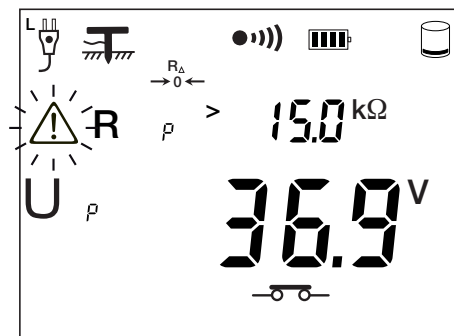

- The voltage on the rod is high: move the rod away from the influence of the earth electrode.

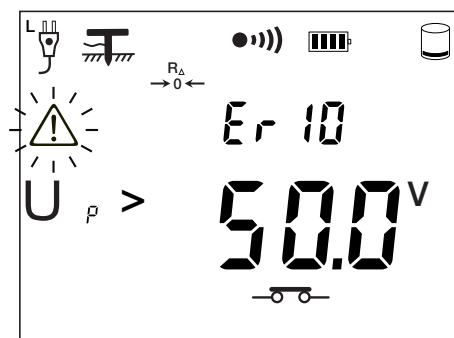

To exit from the error mode, press the TEST button.

## 4.6. TEST OF RESIDUAL CURRENT DEVICE

The device can perform two types of test on RCDs:

- a tripping test in ramp mode,
- a tripping test in pulse mode.

The ramp mode test determines the current at which the RCD trips.  
The pulse mode test determines how long it takes for the RCD to trip.

In what follows, the residual current device will be called RCD.

### 4.6.1. DESCRIPTION OF THE MEASUREMENT PRINCIPLE

The device starts by checking that the RCD can be tested without endangering the user, in other words without threshold voltage,  $U_L$ , exceeding 50 V (or 25 V according to what is defined in SET-UP). It therefore starts by injecting a non-tripping measurement current,  $I_{\Delta N} \times (0.1 \text{ to } 0.5)$ , chosen by the user) between L and PE in order to measure  $R_{LPE}$ , as if it involved a loop or live earth resistance measurement.

It then calculates  $U_F = R_{LPE} \times I_{\Delta N}$  (or  $U_F = R_{LPE} \times 2 I_{\Delta N}$  for a  $\square$  type RCD) which will be the voltage produced during the test. If this voltage exceeds  $U_L$ , the device will not perform the test.

For a more accurate measurement of the threshold voltage, we recommend planting an auxiliary rod, as for live earth measurements. The device then measures  $R_A$  and calculates  $U_F = R_A \times I_{\Delta N}$  (or  $U_F = R_A \times 2 I_{\Delta N}$  for a  $\square$  type RCD).

Once this first part of the measurement has been made, the device goes on to the second part, which depends on the type of test.

- For the ramp mode test, the device generates a sinusoidal current, at the mains frequency, of which the amplitude increases gradually from 0.3 to  $1.06I_{\Delta N}$  between the L and PE terminals. When the RCD opens the circuit, the device displays the exact value of the tripping current and the trip time. This time is an indication and may differ from the trip time in pulse mode, which is closer to the operational reality.
- For the pulse mode test, the device generates a sinusoidal current at the mains frequency, having an amplitude of  $I_{\Delta N}$ ,  $2 I_{\Delta N}$  or  $5 I_{\Delta N}$  between the L and PE terminals, lasting at most 500ms. And it measures the time the circuit-breaker takes to open the circuit. This time must be less than 500ms.

In all cases, if the circuit-breaker does not trip out, the device then sends a current pulse between the L and N terminals. If the circuit opens, it means that the circuit-breaker was incorrectly installed (N and PE reversed).

### 4.6.2. PERFORMING A TEST

Set the switch to the RCD position corresponding to the rated current of the RCD that protects the installation.

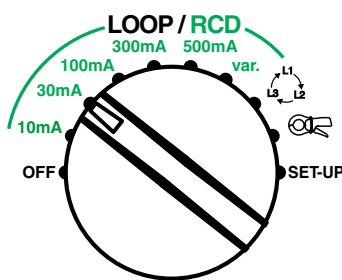

Connect the measuring cable to the device, then to a socket outlet included in the circuit protected by the circuit-breaker to be tested.

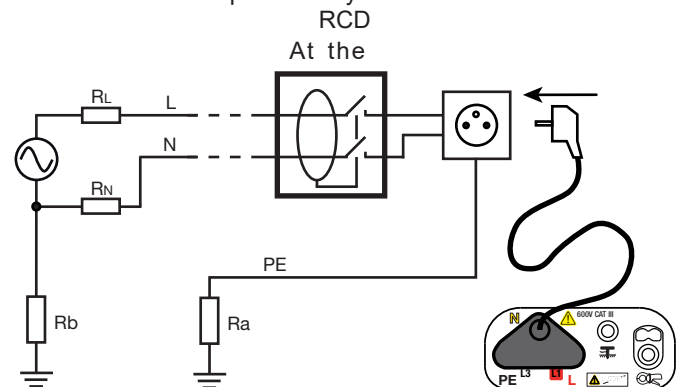

time of connection, the device detects the positions of the phase (L) and of neutral (N) with respect to the protective conductor (PE) and displays them. If necessary, it then automatically switches the L and N terminals so that the loop measurement can be made without modifying the connections of the terminals.

We recommend first disconnecting all loads from the network on which you are performing the RCD test. This eliminates the risk of perturbation of the test by leakage currents due to these loads.

If you have a current clamp, you can measure the leakage currents (see §3.6) at the RCD and so make allowance for them during the test, for the adjustment of  $INtP$ .

To make a more accurate measurement of the fault voltage, plant the auxiliary rod at a distance of more than 25 metres from the earth electrode and connect it to the  $\text{⏏}$  terminal of the device. The  $\text{⏏}$  symbol is then displayed.

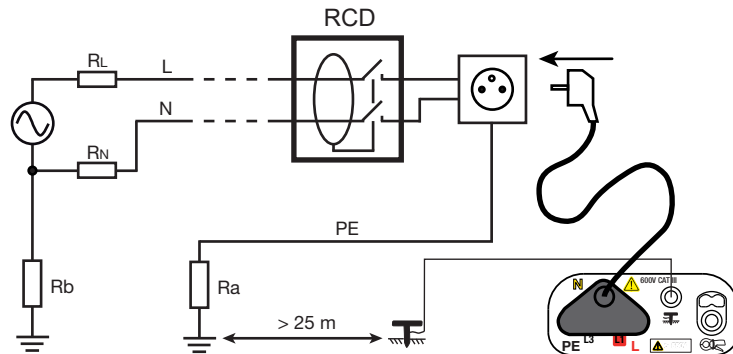

**Particular case:**

To test a residual current device located downstream of another residual current device having a smaller nominal current, you must use the measuring cable terminated by 3 leads and make the connections shown opposite (upstream-downstream method). In this case, the RCD tested is not part of the installation.

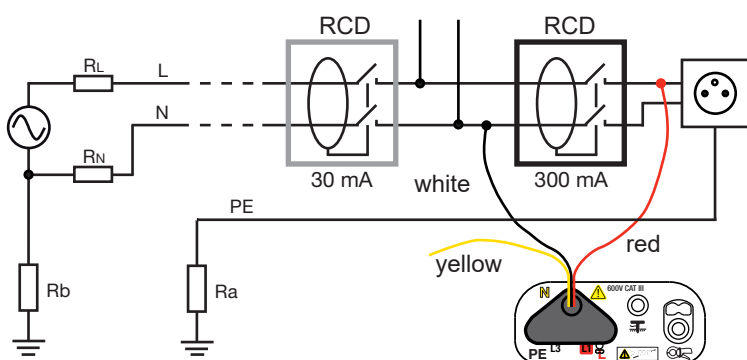

Before starting the measurement, you can parameterize it:

- By adjusting the alarm.  
As default, the device indicates whether the measurement exceeds 50 Ω, but this value can be programmed in SET-UP (see §5.8).
- By choosing the value of UREF that will be used to calculate the short-circuit current (see §5.7.1).
- By choosing the maximum contact voltage,  $U_L$  (see §5.7.2).
- By choosing the nominal current of the RCD  $I_{AN}$ . This current is determined by the setting of the switch: 10, 30, 100, 300, 500mA, or VAR.  
The VAR. setting is used to choose a current of 6 to 650mA (see §5.7.3).
- By choosing non-tripping measurement current  $INtP$  (see §5.7.4).  
If the RCD operates normally and no load is connected downstream, choose  $INtP = 0.4$  or  $0.5 I_{AN}$ , which avoids tripping and gives better resolution and accuracy in the loop measurement.

If it is not possible to disconnect the loads downstream of the RCD, choose  $INtP = 0.2$  or  $0.3 I_{AN}$  in order to tolerate the presence of leakage currents during the measurement and avoid tripping.

For greater security as regards non-tripping, you can measure, in advance, the leakage current (see §3.6 or §4.8) circulating in the RCD before choosing  $INtP$ . Bearing in mind that:  
 $I_{leak} + INtP$  must be less than  $0.5 I_{AN}$ .

- By choosing the number of measurements to be taken into account for smoothing of the measurement (SMOOTH) (see §5.6).
- By choosing whether or not to compensate the leads (see §4.3).

- By activating the alarm.

Set the switch to the RCD position corresponding to the rated current of the RCD that protects the installation.

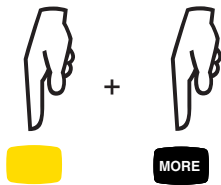
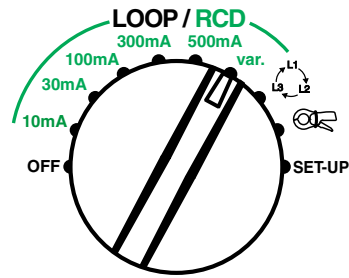
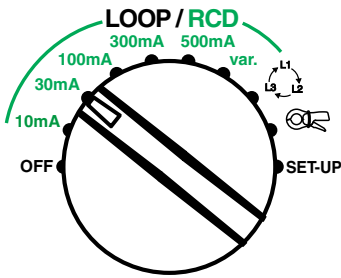

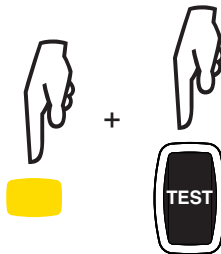

To activate the alarm, press the ALARM key. The device will indicate whether the measurement result crosses the programmed threshold.

- By activating smoothing of the measurement (SMOOTH).







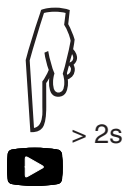

Without turning the switch, press the SMOOTH key.

- Check that you are in fact in tripping mode (  symbol displayed). If not, press the ▲ key until the  symbol is displayed.
- Then choose the type of test (if the tripping mode  is not selected, it is not possible to choose the type of test):

Perform a long press on the ► key.



Each time the ► key is pressed again, the device proposes a type of test:

-  test in ramp mode
-   $\times I_{\Delta N}$  test in pulse mode
-   $2 \times I_{\Delta N}$  [S] test in Pulse mode at  $2I_{\Delta N}$  for the type S RCD
-   $5 \times I_{\Delta N}$  test in Pulse mode at  $5I_{\Delta N}$
-  150mA test in Pulse mode at 150mA
-  250mA test in Pulse mode at 250mA



To validate your choice, perform another long press on the ► key.

- The choice of the shape of the test signal:

Press the ▲ key.



At each press on the ▲ key, the device proposes a different test signal:

- signal starting with a positive half-wave,
- signal starting with a negative half-wave,
- signal made up entirely of positive half-waves,
- signal made up entirely of negative half-waves,
- non-tripping test (see §4.4 and §4.5).



Press the TEST button to start the measurement. The measurement stops automatically.

#### 4.6.3. READING OF THE RESULT

During the measurement, the device starts by displaying “LOOP” during the preliminary measurement, or “-rA-” if a rod is planted; during the test of the RCD, it displays “rCd” and the dashes blink.

A  $\text{S}$  (selective) RCD is normally tested at  $2 I_{\Delta N}$ . The device counts 30 seconds between the preliminary measurement and the test of the RCD proper, in order to allow its demagnetization, and displays “SEC”. This wait can be cut short by pressing the TEST button again.

The results are presented in the same way in the ramp mode as in the pulse mode, with or without an auxiliary rod.

At the end of the measurement, the device displays the following screen:

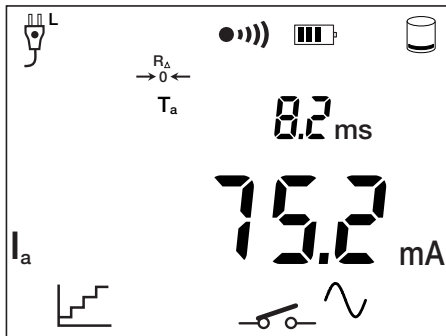

In the ramp mode, the current  $I_a$  at which the RCD trips.  $I_a$  must be between  $0.5 I_{\Delta N}$  and  $I_{\Delta N}$ .

In the pulse mode, tripping time  $T_a$ . It must be less than 300 ms (200 ms in the case of a selective RCD).

Press the MORE key to view the other result screens.

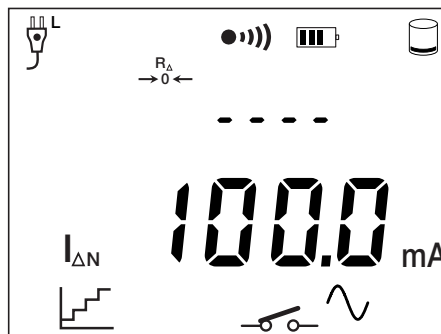

$I_{\Delta N}$  the rated current of the RCD.

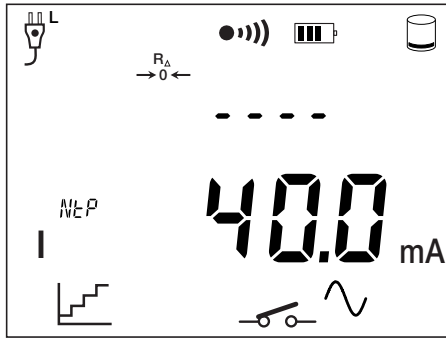

INtP, the current used for the loop measurement made before the test of the RCD (can be programmed in SET-UP).

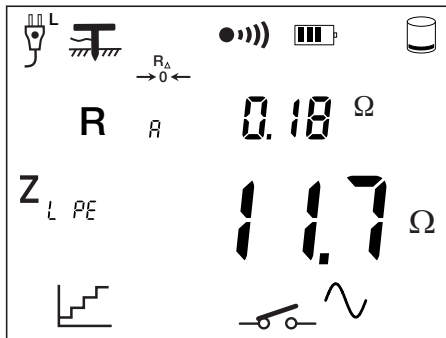

Loop impedance  $Z_{LPE}$  and, if the auxiliary rod is planted, the earth resistance,  $R_A$ .

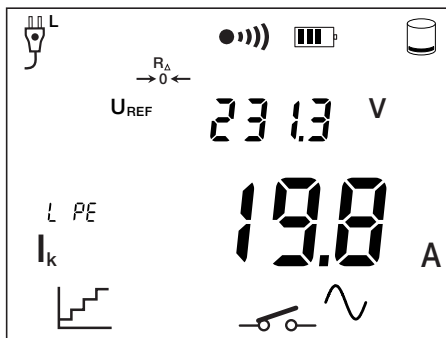

The reference voltage used in calculating the short-circuit current:  
 $I_k = U_{REF} / Z_{LPE}$

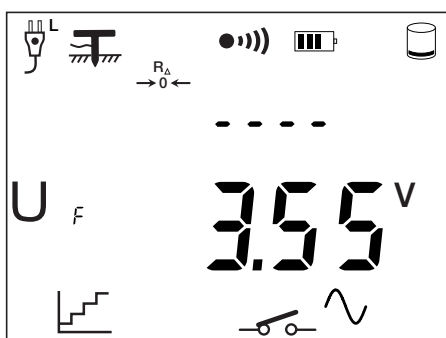

If the auxiliary rod is planted, the fault voltage:  
 $U_F = U_{REF} \times R_A / R_{LPE}$

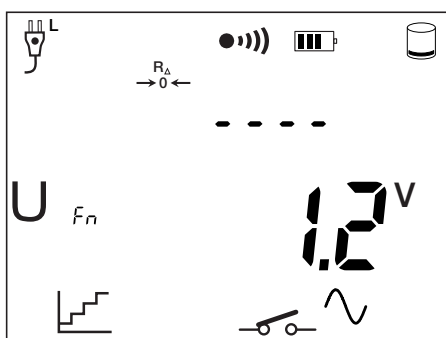

The fault voltage referred to  $I_{\Delta N}$  (or  $2I_{\Delta N}$  in the case of a  $\square$  type RCD).

$$U_{Fn} = R_A \times I_{\Delta N} \text{ or } U_{Fn} = Z_{LPE} \times I_{\Delta N}$$

and for a type  $\square$  RCD:

$$U_{Fn} = R_A \times 2I_{\Delta N} \text{ or } U_{Fn} = Z_{LPE} \times 2I_{\Delta N}$$

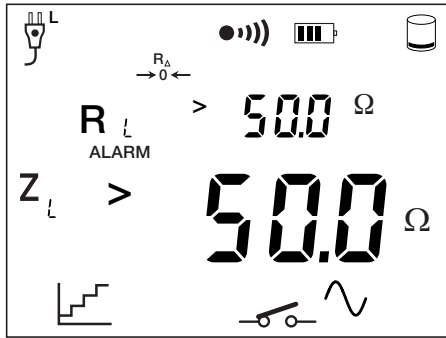

The resistance alarm threshold,  $R_L$ , and the impedance alarm threshold,  $Z_L$ .

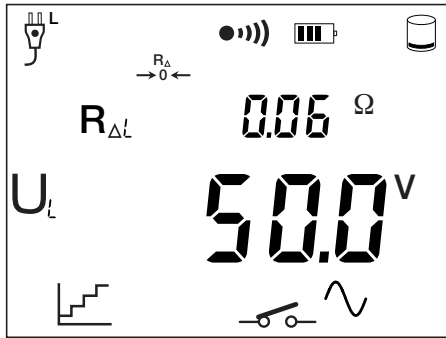

The compensation of the L lead. The ► key is used to view the compensation of the N and PE leads ( $R_{AN}$  and  $R_{APE}$ ) along with the resistance of the rod ( $R_P$ ) if it is connected.

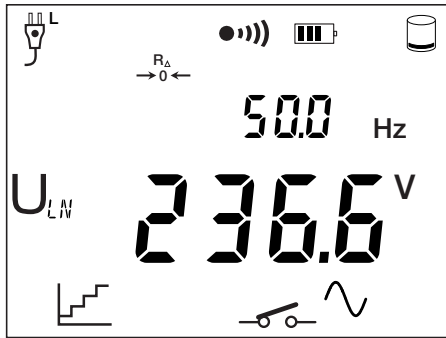

Voltage  $U_{LN}$  and its frequency before the start of the measurement. The ► key is used to view voltages  $U_{LPE}$ ,  $U_{NPE}$ ,  $U_P$  (voltage on the rod if it is connected) and  $U_{LN}$ .

#### 4.6.4. ERROR INDICATION

The commonest errors in the case of a test of an RCD are:

- A connection error (see §4.4.4).
- A voltage on the protective conductor that is too high (see §4.4.4).
- An earth rod resistance that is too high (see §4.5.4).
- A voltage on the rod that is high (see §4.5.4).

The circuit-breaker trips out when it should not. The leakage currents are probably too high. First disconnect all loads from the network on which you are performing the test. Then perform a second test with the current reduced (in  $U_F$  check) as far as possible. If the problem persists, the circuit-breaker must be declared defective.

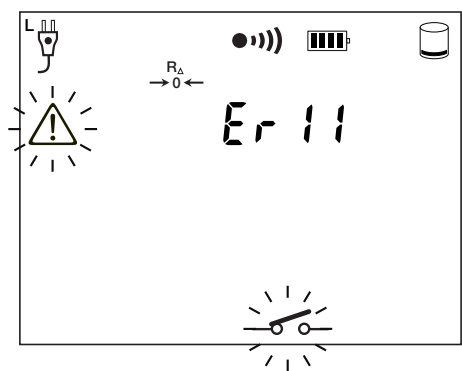



- The RCD failed to trip in the ramp mode test. But, to ensure the users' safety, the RCD must trip at a current between  $I_{\Delta N}/2$  and  $I_{\Delta N}$ . Check the wiring of the RCD. If there is nothing wrong with it, the RCD must be declared defective and replaced.

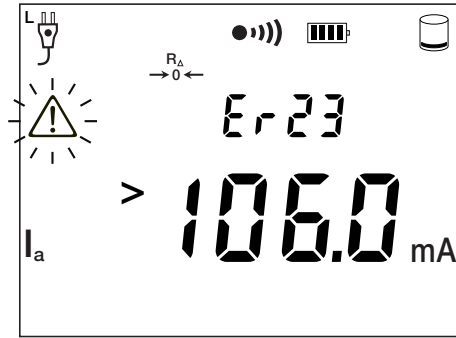

- The RCD failed to trip in the test in pulse mode. But, to ensure the safety of the users, an RCD must trip in less than 500 ms. Check the wiring of the RCD. If there is nothing wrong with it, the RCD must be declared defective and replaced.

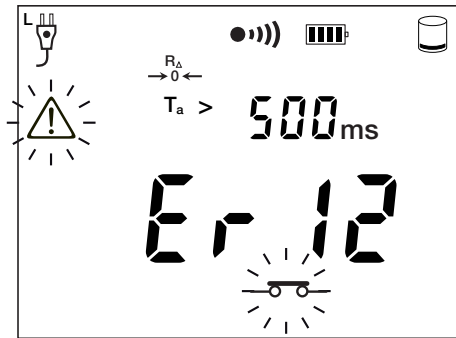

- The device is too hot. Wait until it cools before resuming the measurements.

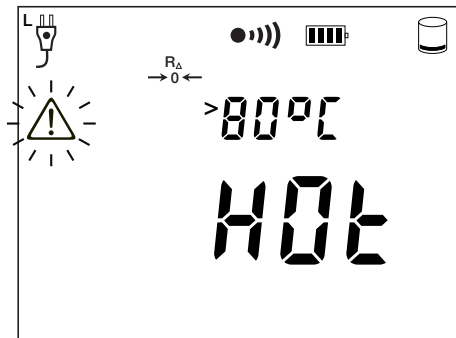

To exit from the error mode, press the TEST button.

## 4.7. DIRECTION OF PHASE ROTATION

This measurement is made on a three-phase network. It is used to check the phase order of the network. This can be done by the “3-wire” method or by the “2-wire” method.

### 4.7.1. DESCRIPTION OF THE MEASUREMENT PRINCIPLE

In a “3-wire” measurement, the device checks that the three signals are of the same amplitude and at the same frequency. It then measures the phase differences between the three phases and deduces their order (forward or reverse direction).

In a “2-wire” measurement, the device checks voltage  $U_{12}$  in amplitude and frequency, then stores its phase. It then checks voltage  $U_{32}$  in amplitude and frequency. It then compares its phase to that of  $U_{12}$  and deduces the phase order (forward or reverse direction).

### 4.7.2. MAKING A MEASUREMENT

For the connection diagrams and the measurement process, refer to §3.5.1 and 3.5.2.

### 4.7.3. READING OF THE RESULT



1.2.3: the phase order is direct.  
3.2.1: the phase order is reversed.

Press the MORE key to view the other result screen.  
The voltage between phase,

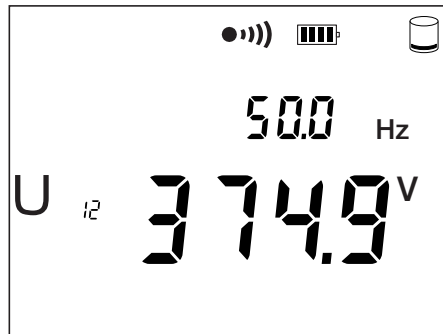

$U_{12}$ , and its frequency.  
The ► key is used to view voltages  $U_{23}$  and  $U_{31}$  and their frequencies.

### 4.7.4. ERROR INDICATION

The commonest errors in the case of a test of direction of phase rotation are:

- One of the three voltages is outside the measurement range. (See §4.2.3).
- The frequency is outside the measurement range (See §4.2.3).

- The voltages are not of the same order of magnitude.

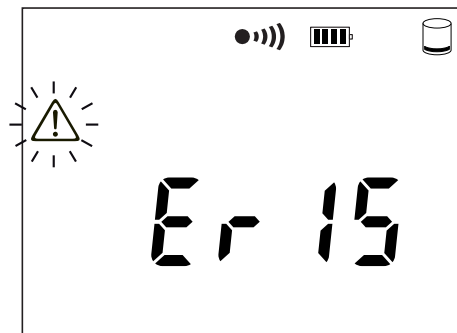

- In a "2-wire" measurement, the frequencies measured are too different.

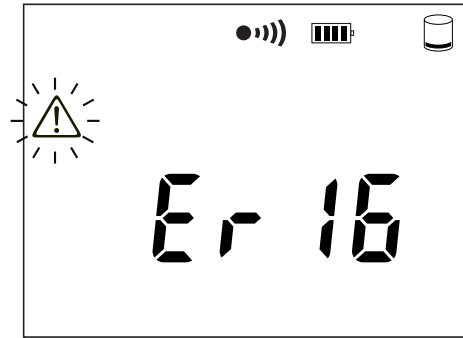

- In a "2-wire" measurement, the maximum time allowed for the voltage measurement, 10 seconds, is exceeded.

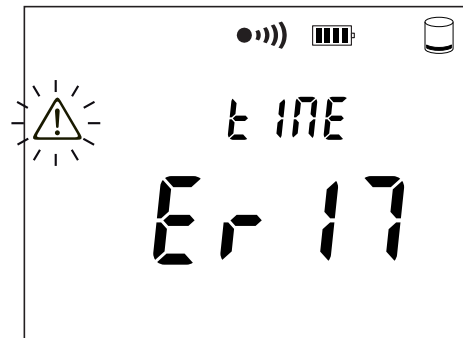

To exit from the error mode, press the TEST button.

## 4.8. CURRENT MEASUREMENT

This measurement requires the use of an optional current clamp.

It can measure very low currents (of the order of a few mA) like fault currents, and high currents (of the order of a few hundred Amperes).

### 4.8.1. DESCRIPTION OF THE MEASUREMENT PRINCIPLE

The clamp is connected to the device at 3 points. Between two points, there is a resistance that enables the device to recognize the type of clamp. The measurement is made between the other two points.

Knowing the ratio of the clamp, the device displays a direct reading of the current.

### 4.8.2. MAKING A MEASUREMENT

For the connection diagrams, refer to §4.6.1.

Before starting the measurement, you can parameterize it:

- By adjusting the alarm.

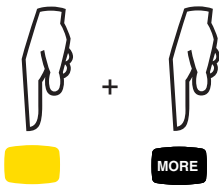

As default, the device indicates whether the measurement exceeds 30mA, but the value can be programmed in SET-UP (see §5.8).

To activate the alarm, press the ALARM key. The device will emit an audible signal if the measurement result exceeds 30mA (default value; can be programmed in SET-UP).

There is no need to press the TEST button because the measurement is made at all times.

### 4.8.3. READING OF THE RESULT

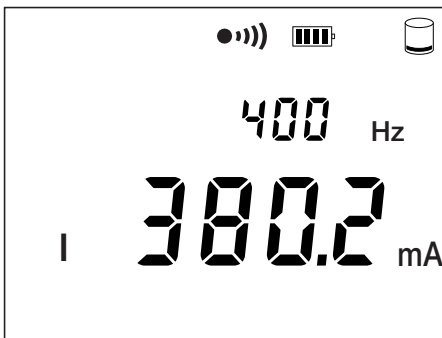

The measured current and its frequency.

Press the MORE key to view the other result screens.

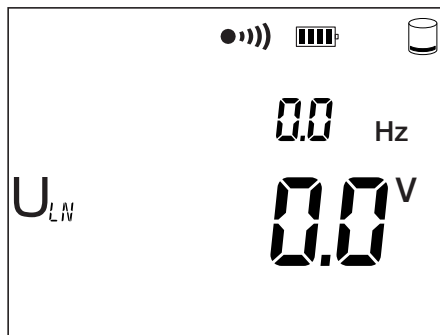

The present voltage  $U_{LN}$  and its frequency.

The ► key is used to view voltages  $U_{LPE}$  and  $U_{NPE}$ .

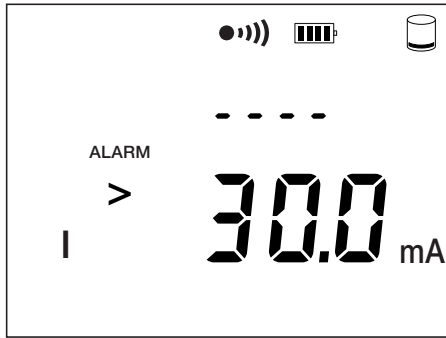

The current alarm threshold.

#### 4.8.4. ERROR INDICATION

The commonest errors in the case of a current measurement are:

- The clamp is not connected.
- The current or frequency is outside the measurement range.

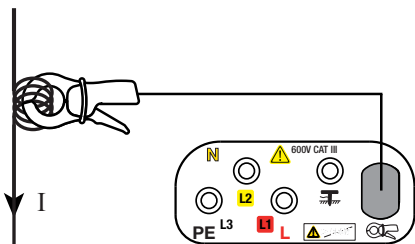

If the current measured by the clamp is too low. Use a clamp having a lower ratio or pass the conductor through the clamp several times to increase the measured current.

Here, the conductor passes through the clamp 4 times. You will have to divide the measured current by 4 to know the true value of I.

If the current measured by the clamp is too high, use a clamp having a higher ratio.

To exit from the error mode, you must eliminate the cause of the error. Here, this means measuring a power supply of which the voltage and frequency are compatible with the specifications of the device (see §9.2.5).

## 5. SET-UP

This function is used to:

- set the date and time,
- choose the type of power supply to the device and the whether or not the standby switching mode is activated,
- choose whether the audible signal is activated or not
- choose the time constant of the measurement smoothing filter
- choose the reference voltages for the calculation of short-circuit current  $I_k$
- choose the maximum contact voltage  $U_L$
- choose the nominal current for the VAR setting of the switch,
- choose loop measurement current  $I_{NtP}$  so as to avoid untimely tripping,
- set the alarm thresholds for the loop, earth, and current measurements,
- set the communication rate of the device,
- restore the default configuration of the device,
- display the internal parameters of the device.

### 5.1. ACCESS TO SET-UP

Set the switch to SET-UP.

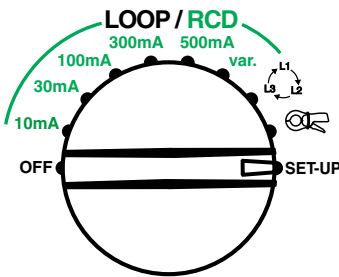

The display is as follows:

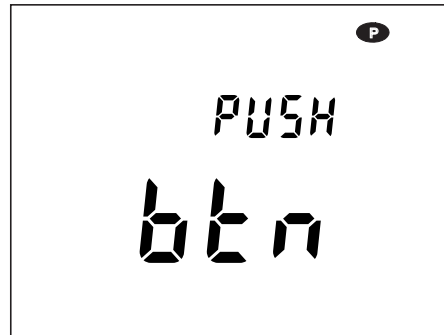

The device switches to permanent mode (display of the **P** symbol) to prevent automatic standby switching interrupting the configuration process.

The general operating principle is as follows:

- The item that can be modified blinks and can be modified using the ▲ and ▼ keys.
- The other items to be modified are accessed using the ► key.

The modifications are validated upon return to this screen (PUSH btn).  
To exit without saving, turn the switch to any position.

### 5.2. SETTING THE DATE AND TIME

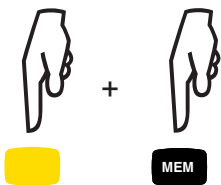

Use the ▲ key to choose the format in which the date is displayed:

- EU (European format): dd.mm
- US (American format): mm.dd



Use the ▲ and ▼ keys to set the year (YEAR).



Use the ▲ and ▼ keys to set the date (dAtE).



Use the ▲ and ▼ keys to set the time (tiME).



Press the MEM key one last time to validate the modifications and return to the PUSH btn screen.



### 5.3. TYPE OF POWER SUPPLY

The default configuration is battery operation (bAtt) with switching to standby at the end of 5 minutes with no action on the switch or the keys.



+



Use the ▲ key to specify the type of power supply:

- batteries (bAtt)
- rechargeable batteries (niMH)



The device supports both types of power supply, but their voltages are different.



Use the ▲ key to choose between automatic standby switching (SHUt On) to save the batteries or no automatic switching (SHUt OFF). In the latter case, the **P** symbol is displayed at all times.



If automatic standby switching is selected, use the ▲ and ▼ keys to set the operating time of the device, between 1 and 59 minutes.



Press the ► key one last time to validate the modifications and return to the PUSH btn screen.



## 5.4. AUDIBLE SIGNAL

As default, the audible signal is activated.

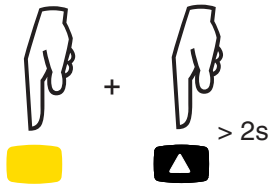

Use the ▲ key to activate (On) or deactivate (OFF) the audible signal (biP).

When the audible signal is active, each key press, each crossing of an alarm threshold, and each error will be signalled.

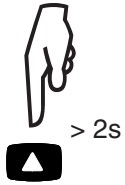

Use a second long press on the ▲ key to validate the modifications and return to the PUSH btn screen.

## 5.5. VIEWING THE INTERNAL PARAMETERS OF THE DEVICE



Successive presses on the ► key let you view, in order:

- the serial number of the device (Sn),
- the version of the internal software (SOft),
- the version of the electronics on the boards (HARd),
- the date of adjustment of the device,
- all segments of the display unit lit.

## 5.6. SMOOTHING OF THE MEASUREMENT (SMOOTH)

As default, smoothing averages 3 consecutive measurements.

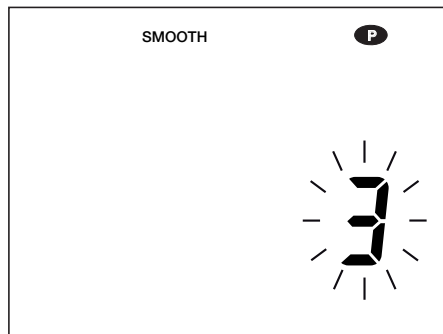
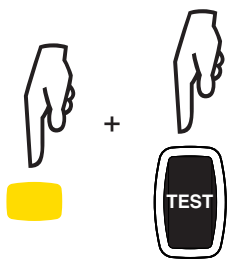

Use the ▲ key to change the number of measurements included in the smoothing process (between 2 and 5).

The duration of the measurement is proportional to the number of measurements chosen. Smoothing applies only to the loop and live earth measurements.



Press the TEST button again to validate the changes and return to the PUSH btn screen.



## 5.7. CONFIGURATION OF THE MEASUREMENTS

### 5.7.1. CHOICE OF REFERENCE VOLTAGE

As default,  $U_{REF} = 230 \text{ V}$ .

Press the MORE key.

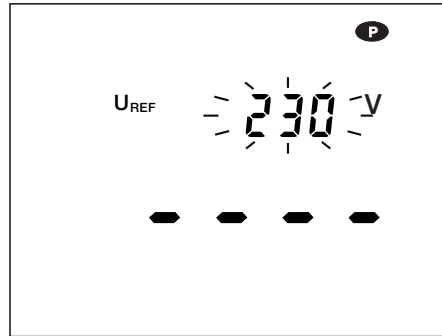

Use the ▲ key to choose the reference voltage,  $U_{REF}$ , for the calculation of  $I_k = U_{REF}/R_{LPE}$ :

- MEAS:  $U_{REF}$  = the voltage measured by the device.
- 110 V
- 127 V
- 220 V
- 230 V
- 380 V
- 400 V.

### 5.7.2. CHOICE OF MAXIMUM CONTACT VOLTAGE $U_L$

As default  $U_L = 50 \text{ V}$ .

Press the MORE key again.

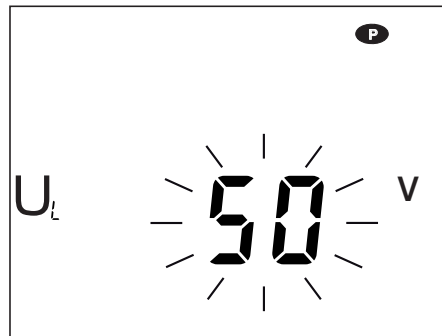

Use the ▲ key to choose the maximum contact voltage,  $U_L$ :

- 50 V.
- 25 V: for a measurement in a damp environment.

### 5.7.3. CHOICE OF NOMINAL CURRENT FOR THE TEST OF RCDS IN VARIABLE MODE

As default  $I_{\Delta N} = 30 \text{ mA}$ .

Press the MORE key a third time.

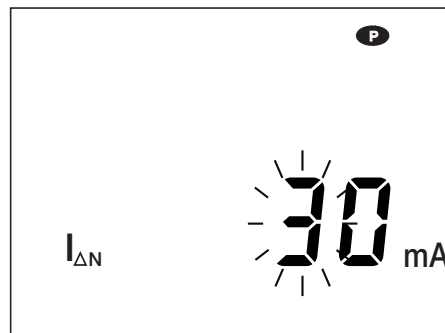

Use the ▲ and ▼ keys to set the nominal current of the RCD,  $I_{\Delta N}$ , for the VAR position of the switch (between 6 and 650mA).

### 5.7.4. CHOICE OF LOOP MEASUREMENT CURRENT

As default  $INT_P = 0.4 I_{\Delta N}$ .

Press the MORE key a fourth time.

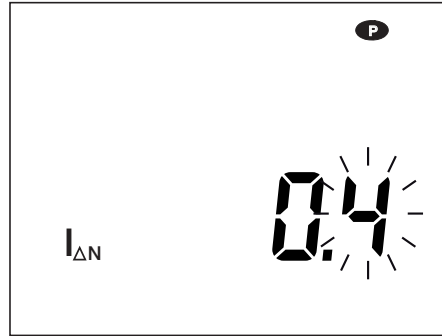

Use the ▲ key to choose the loop measurement current,  $INT_P$ , as a function of the rated current of the RCD that protects the installation  $I_{\Delta N}$ , between 0.1 and 0.5  $I_{\Delta N}$ .

Press the MORE key a fifth time.



Press the MORE key one last time to validate the modifications and return to the PUSH btn screen.

### 5.8. ALARM THRESHOLDS

The default alarm thresholds are:

- resistance measurement: < 50.00 Ω
- current measurement: > 30.0 mA

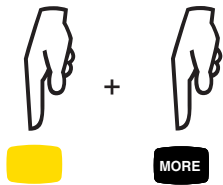

Use the ► and ▼ keys to set the resistance alarm threshold, for the loop measurement or the earth measurement, between 0.00 and 3999 Ω.

Select the direction of the alarm (< or >) and the position of the decimal point (.).



Use the ► and ▼ keys to set the current alarm threshold, between 0.00 mA and 39.99 A.

Select the direction of the alarm (< or >) and the position of the decimal point (.).



Press the MORE key one last time to validate the modifications and return to the PUSH btn screen.

### 5.9. DEFAULT CONFIGURATION

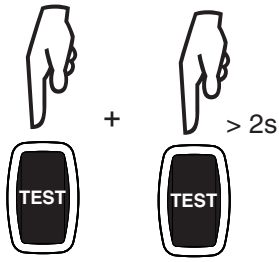

To restore the factory configuration of the device (dFLT), perform a long press on the TEST button. Only the date, the time, and any recorded measurements will not be modified.

### 5.10. COMMUNICATION RATE FOR PRINTING

The default communication rate is 9600 Bauds

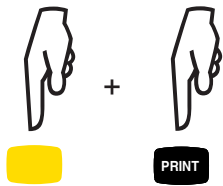

Use the ▲ key to choose the communication rate (bAUd): 300, 600, 1200, 2400, 4800, or 9600 Bauds.



Press the PRINT key again to validate the modifications and return to the PUSH btn screen.



Press the PRINT key when in the PUSH btn screen to print out the configuration of the device.

## 6. STORAGE

### 6.1. ORGANIZATION OF THE MEMORY

The device has 100 memory locations to record measurements. These comprise measurements (TEST) that are arranged in blocks (OBJ.)

A block number (OBJ.) may for example represent an installation and the measurement numbers (TEST) the various measurements made on the installation.

### 6.2. STORAGE

As soon as a measurement is over, you can record the measurement result and all associated values (date, time, type of measurement, parameters, etc.).

It is therefore important to check the date and time before storing any results (see §5.2)

Press the MEM key.



The slot proposed as default is the first free memory slot (FrEE). Here, OBJ. = 1 and TEST = 1.

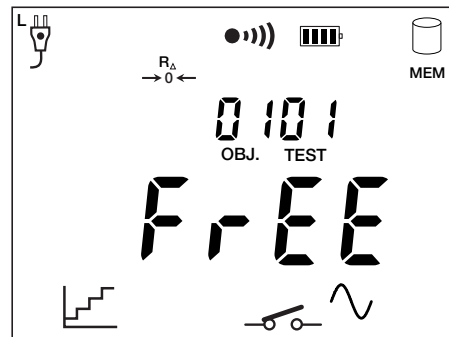

To change the slot (Object or Test), use the ► and ▲ or ▼ keys. The numbers must be between 01 and 99.

If the slot is already taken, the device displays OCC, but you can even so overwrite it and put your new measurement in place of the old.

Press the MEM key again.



The FrEE symbol turns into rEC to report that the measurement is being recorded. The device then returns to voltage measurement mode.

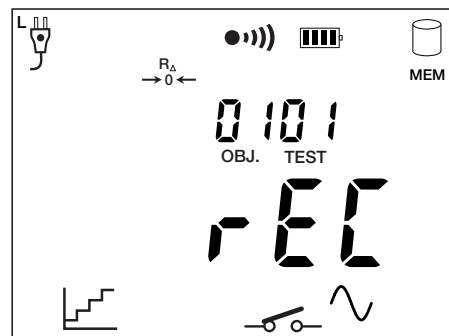

### 6.3. READOUT

To read out a measurement, press the MR key.

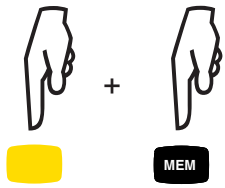

To choose the slot, use the ► and ▲ or ▼ keys to change the block (OBJ.) and measurement (TEST) numbers. Free slots are identified by FREE and occupied slots by rCd, VOLT, LOOP, rA, etc., depending on the type of measurement recorded.

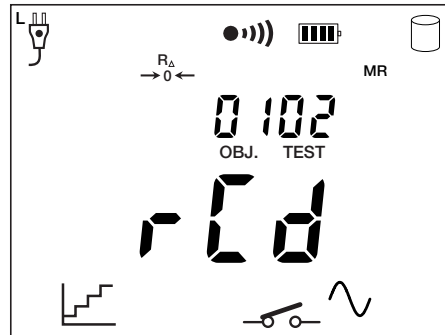

Press the MEM key again.



The recorded measurement is displayed and the MR symbol blinks. You can use the MORE key to view all of the information concerning the measurement, as during an immediate reading of a measurement result.

### 6.4. ERASURE

It is possible to erase a single measurement (TEST), a single memory block (OBJ.) with all of the measurements that it contains, or the whole memory.

Set the switch to SET-UP.

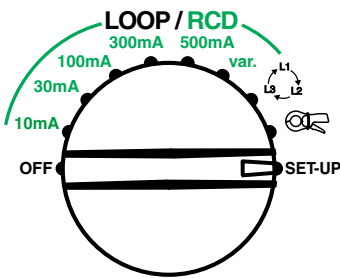

Press the MEM key.



#### 6.4.1. PARTIAL ERASURE

Press the ► key.



Use the ► and ▲ or ▼ keys to select the block (OBJ.) or measurement (TEST) to be erased, making it blink.

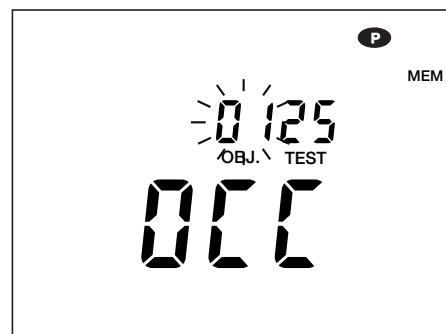

Perform a long press on the MEM key.

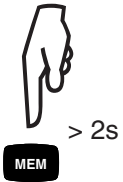

The selected block or measurement is erased and OCC is replaced by FREE, followed by a return to the PUSH btn screen.

### 6.4.2. COMPLETE ERASURE

Perform a long press on the MEM key.

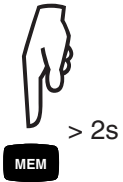

The whole memory is erased and the display "Clr ALL" is replaced by "FrEE ALL".



### 6.5. ERRORS

The commonest errors during storage are the following:

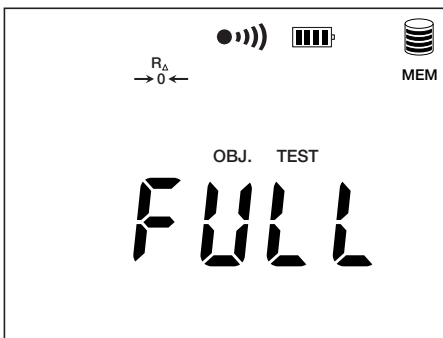

The memory is full and you try to record a measurement. It is then necessary to erase records to clear space in memory.

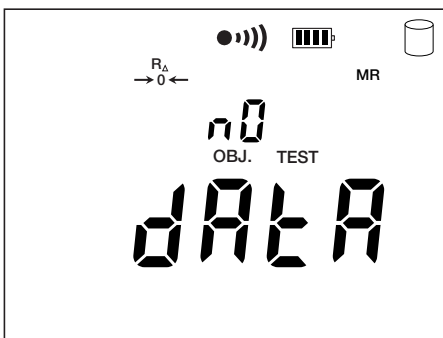

The memory is empty and you try to read it.

## 7. PRINTING

This function requires the use of a serial printer, available as an option.

It is used to print a measurement as soon as it is over.

Connect the printer to mains, then connect it to the device using the optical-RS232 communication cord provided. Insert the provided metallic adapter between the cord and the printer.

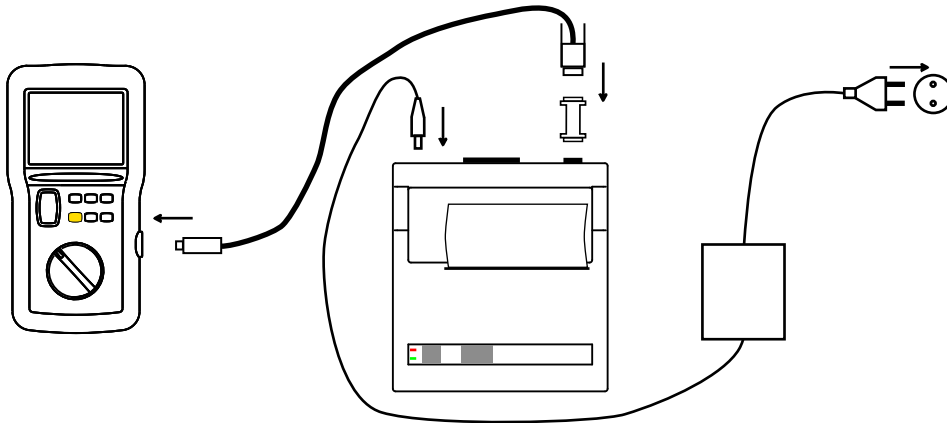

Press the PRINT key.

PRINT

Example of printing ticket:

```
*****
* LOOP MEASUREMENT *
*****
MEAS. MODE.: TRIP
Z(LPE): 1.09 ohms
R(LPE): 1.08 ohms
L(LPE): 0.00 mH
Ik(LPE): 212.8 A
Smooth: 1 meas.
*****
COMPENSATION SETTING:
on R(L): 0.06 ohms
on R(N): 0.06 ohms
on R(PE): 0.06 ohms
*****

*****
* R.C.D. *
*****
Trip current: 23.6 mA
Trip delay..: 19.4 ms
Test mode...: SLOPE
*****
```

## 8. DATA EXPORT SOFTWARE

---

The data export software, Transfertview, is used to recover the recorded measurements and transfer them into an Excel™ file.

Start by installing Transfertview using the provided CD.

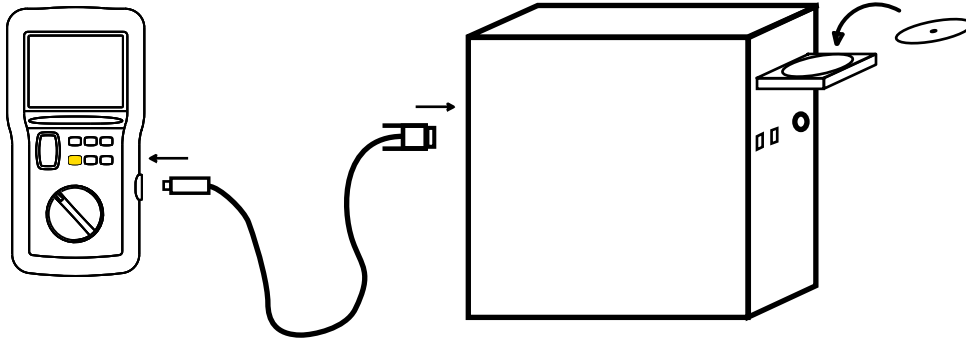

Power up the device, then connect it to the PC using the optical-RS232 communication cord.

Start the Transfertview software, then follow the instructions. You can also use Transfertview's Help function.



## 9. TECHNICAL CHARACTERISTICS

### 9.1. REFERENCE CONDITIONS

Quantity of influence	Reference values
Temperature	20 ± 3 °C
Relative humidity	45 to 55% RH
Supply voltage	8.5 ± 0.5 V
Electric field	< 1 V/m
Magnetic field	< 40 A/m

The **intrinsic uncertainty** is the error defined under the reference conditions.

The **operating uncertainty** includes the intrinsic uncertainty plus the effects of variation of the quantities of influence (supply voltage, temperature, spurious currents, etc.) as defined in standard IEC-61557.

### 9.2. ELECTRICAL CHARACTERISTICS

#### 9.2.1. VOLTAGE MEASUREMENTS

**Particular reference conditions:**

- Peak factor = 1,414 en AC
- AC component <0.1% in DC measurement
- DC component <0.1% in AC measurement

Specified measurement range	2.0 – 79.9 V	80.0 – 399.9	400 - 550 V
Resolution	0.1 V	0.1 V	1 V
Intrinsic uncertainty in DC	± (4% + 5 ct)	± (2% + 1 ct)	± (2% + 1 ct)
Intrinsic uncertainty in AC	± (3% + 5 ct)	± (1.5% + 1 ct)	± (1.5% + 1 ct)
Input impedance	440 kΩ		
Frequency of use	DC and 15.3 ... 450 Hz		

#### Contact voltage measurements

Specified measurement range (AC)	2.0 – 100.0 V
Intrinsic uncertainty	± (15% + 2 ct)
Input impedance	4.5 MΩ in series with 4.7 nF
Frequency of use	15.3 ... 65 Hz

This voltage is displayed only if it exceeds  $U_L$ .

#### Measurements of potential of the voltage probe

The characteristics are the same as in the voltage measurements.

This voltage must normally be between 0 and  $U_L$ .

#### 9.2.2. FREQUENCY MEASUREMENTS

**Particular reference conditions:**

- Voltage ≥ 10 V $\sim$
- or current ≥ 100 mA $\sim$  for the MN20 clamp,
- ≥ 100 mA $\sim$  for the C172 clamp,
- ≥ 1 A $\sim$  for the C176 clamp.

Beyond these values, the frequency is indeterminate (display of - - - - ).

Specified measurement range	15.3 – 399.9 Hz	400.0 – 499.9 Hz
Resolution	0.1 Hz	1 Hz
Intrinsic uncertainty	± (0.1% + 1 ct)	

### 9.2.3. LOOP IMPEDANCE AND LIVE EARTH MEASUREMENTS

#### Particular reference conditions:

- Voltage of the installation: 90 to 550 V.
- Frequency of the installation: 15.3 to 65 Hz.
- Resistance of the leads: compensated.
- Inductance of the leads: negligible.
- Impedance of the inductive part of the measured impedance: < 0.1 x the resistive part.
- Contact voltage (potential of the protection conductor with respect to the local earth): < 5 V.
- Resistance of the voltage measurement probe: ≤ 15 kΩ.
- Potential of the voltage probe with respect to PE: ≤ 50 V.
- Residual leakage current of the installation: zero.

Compensation of the leads up to 5 Ω.

Measurement current: 0.1 0.2 0.3 0.4 or 0.5 I<sub>ΔN</sub> can be set in SET-UP.

Range I <sub>ΔN</sub>	10mA		30mA	
Specified measurement range <sup>1</sup>	20 – 3,999 Ω	4.00 – 10.00 kΩ	7.0 – 399.9 Ω	400 – 3,333 Ω
Resolution	1 Ω	10 Ω	0.1 Ω	1 Ω
Intrinsic uncertainty <sup>2</sup>	± (15% + 75 ct)	± (10% + 15 ct)	± (15% + 175 ct)	± (10% + 15 ct)

Range I <sub>ΔN</sub>	100mA		300mA	
Specified measurement range <sup>1</sup>	5.00 – 399.9 Ω	400 – 1,000 Ω	0.20 – 39.99 Ω	40.0 – 333.3 Ω
Resolution	0.1 Ω	1 Ω	0.01 Ω	0.1 Ω
Intrinsic uncertainty <sup>2</sup>	± (15% + 75 ct)	± (10% + 15 ct)	± (15% + 75 ct)	± (10% + 15 ct)

Range I <sub>ΔN</sub>	500mA	
Specified measurement range <sup>1</sup>	0.20 – 39.99 Ω	40.0 – 200.0 Ω
Resolution	0.01 Ω	0.1 Ω
Intrinsic uncertainty <sup>2</sup>	± (15% + 100 ct)	± (10% + 15 ct)

1: For each range, the upper limit of the measurement range is specified for U<sub>L2</sub>=?50?V. It is divided by 2 if U<sub>L2</sub>= 25?V.

2: Variable range:

I<sub>ΔN</sub> < 10mA: the intrinsic uncertainty is equal to (15%+25 ct) x 10/ I<sub>ΔN</sub> (in mA)

I<sub>ΔN</sub> > 10mA: the intrinsic uncertainty must be interpolated between the fixed ranges specified above.

#### Characteristics of the short-circuit current calculation:

Calculation formula:  $I_k = U_{REF} / Z_{LPE}$

Calculation range <sup>3</sup>	0.1 – 399.9 A	400 – 3,999 A	4.00 – 39.90 kA
Resolution	0.1 A	1 A	10 A
Intrinsic uncertainty	$= \sqrt{(\text{Intrinsic uncertainty on the voltage measurement if } U_{MEAS} \text{ is used})^2 + (\text{Intrinsic uncertainty on the loop measurement})^2}$		

3: In practice, the Maximum value calculated cannot exceed 5000A.

### 9.2.4. TEST OF RESIDUAL CURRENT DEVICE

#### Particular reference conditions:

- Voltage of the installation: 90 to 550 V.
- Frequency of the installation: 15.3 to 65 Hz.
- Contact voltage (potential of the protective conductor with respect to the local earth): < 5 V.
- Resistance of the voltage probe (if used): ≤ 15 kΩ.
- Potential of the voltage probe (if used) with respect to the PE: <  $U_L$ .
- Residual leakage current of the installation: zero.

#### Limitation of the ranges in full-wave mode ()

Range $I_{\Delta N}$	10mA	30mA	100mA	300mA	500mA	var.
Ramp	yes	yes	yes	yes	yes	yes
Pulse at $I_{\Delta N}$	yes	yes	yes	yes	yes	yes
Pulse at $2 \times I_{\Delta N}$	yes	yes	yes	yes	NO	yes if ≤ 325mA
Pulse at $5 \times I_{\Delta N}$	yes	yes	yes	NO	NO	yes if ≤ 130mA
Pulse at 150mA	yes	yes	NO	NO	NO	yes if ≤ 30mA
Pulse at 250mA	yes	yes	NO	NO	NO	yes if ≤ 50mA

#### Limitation of the ranges in half-wave mode ()

Range $I_{\Delta N}$	10mA	30mA	100mA	300mA	500mA	var.
Ramp	yes	yes	yes	yes	NO	yes if ≤ 320mA
Pulse at $I_{\Delta N}$	yes	yes	yes	yes	NO	yes if ≤ 320mA
Pulse at $2 \times I_{\Delta N}$	yes	yes	yes	NO	NO	yes if ≤ 160mA
Pulse at $5 \times I_{\Delta N}$	yes	yes	NO	NO	NO	yes if ≤ 65mA
Pulse at 150mA	yes	yes	NO	NO	NO	yes if ≤ 15mA
Pulse at 250mA	yes	yes	NO	NO	NO	yes if ≤ 30mA

#### Characteristics in pulse mode

Range $I_{\Delta N}$	10mA - 30mA - 100mA - 300mA - 500mA - 650mA Variable (6 to 650mA) <sup>4</sup>				
Type of test	Loop measurement	Non-tripping test	Tripping test	Tripping test (selective)	Tripping test
Test current	$0.1 \times I_{\Delta N} \dots 0.5 \times I_{\Delta N}$ <sup>5</sup>	$0.5 \times I_{\Delta N}$	$I_{\Delta N}$	$2 \times I_{\Delta N}$	$5 \times I_{\Delta N}$
Intrinsic uncertainty on the test current	+0 -7% ± 2 mA	+0 -7% ± 2 mA	-0 +7% ± 2 mA	-0 +7% ± 2 mA	-0 +7% ± 2 mA
Maximum duration of application of the test current	from 32 to 72 periods	1,000 ms	500 ms	500 ms	40 ms

4: the upper limit (650mA) of the variable range depends on the type of test performed and on the shape of the test signal. It can range from 15 to 650mA.

5: this current is adjustable in steps of  $0.1 I_{\Delta N}$  and cannot be less than 3mA.

#### Characteristics in ramp mode

Range $I_{\Delta N}$	10mA - 30mA - 100mA - 300mA - 500mA - 650mA Variable (6 to 999mA) <sup>4</sup>		
Type of test	Loop measurement	Non-tripping test	Tripping test
Test current	$0.1 \times I_{\Delta N} \dots 0.5 \times I_{\Delta N}$ <sup>5</sup>	$0.5 \times I_{\Delta N}$	$0.9573 \times I_{\Delta N} \times k / 28$ <sup>6</sup>
Intrinsic uncertainty on the test current	+0 -7% ± 2 mA	+0 -7% ± 2 mA	-0 +7% ± 2 mA
Maximum duration of application of the test current	from 32 to 72 periods	1,000 ms	3,400 ms
Intrinsic uncertainty on the tripping current indication	-	-	-0 +7% + 3.3 % $I_{\Delta N} \pm 2$ mA Resolution de 0.1 mA up to 400 mA and 1 mA thereafter

6: k is between 9 and 31. The ramp so generated ranges from  $0.3 I_{\Delta N}$  to  $1.06 I_{\Delta N}$  in 22 steps of 3.3%  $I_{\Delta N}$  each, with a duration of 200 ms.

**Characteristics of the trip time ( $T_A$ )**

	Pulse mode		Ramp mode
Specified measurement range	5.0 – 399.9 ms	400 - 500 ms	10.0 – 200.0 ms
Resolution	0.1 ms	1 ms	0.1 ms
Intrinsic uncertainty	± 2 ms		± 2 ms

**Characteristics of the short-circuit current calculation:**

See §9.2.3.

**Characteristics of the fault voltage calculation ( $U_F$ ):**

Calculation formula:  $I_{AN} \times Z_{LPE}$  (or  $R_A$ ) and  $2 \times I_{AN} \times Z_{LPE}$  (or  $R_A$ ) if the test is performed at  $2 \times I_{AN}$ .

Specified measurement range	5.0 – 50.0 V
Resolution	0.1 V
Intrinsic uncertainty	± 10%

**9.2.5. CURRENT MEASUREMENT**

**Particular reference conditions:**

- Peak factor = 1.414
- DC component < 0.1%
- Frequency: 15.3 to 450 Hz.

**Characteristics with the MN20 clamp:**

Transformation ratio: 1,000 / 1

Specified measurement range	5.0 – 399.9mA	0.400 – 3.999 A	4.00 – 39.99 A
Resolution	0.1mA	1mA	10mA
Intrinsic uncertainty	± (2% + 10 ct)	± (1.5% + 2 ct)	± (1.2% + 2 ct)

**Characteristics with the C172 clamp:**

Transformation ratio: 1000 / 1

Specified measurement range	5.0 – 399.9mA	0.400 – 3.999 A	4.00 – 39.99 A
Resolution	0.1mA	1mA	10mA
Intrinsic uncertainty	± (2% + 10 ct)	± (1.5% + 2 ct)	± (1.2% + 2 ct)

**Characteristics with the C176 clamp:**

Transformation ratio: 10 000 / 1

Specified measurement range	0.055 – 3.999 A	4.00 – 39.99 A	40.0 – 399.9 A
Resolution	1mA	10mA	100mA
Intrinsic uncertainty	± (2% + 10 ct)	± (1.5% + 2 ct)	± (1.2% + 2 ct)

**9.2.6. DIRECTION OF PHASE ROTATION**

**Particular reference conditions:**

- Three-phase network.
- Voltage of the installation: 90 to 550 V.
- Frequency: 50 Hz.
- Frequency stability: 0.1% during the measurement.
- Acceptable level of amplitude unbalance: 20%.
- Acceptable level of phase unbalance: 10%.
- Acceptable level of harmonics (voltage): 10%.

**Characteristics:**

- Frequency range (approximately ± 6% with respect to the theoretical value): between 15.7 and 17.7 Hz (for 16.67 Hz) or between 47 and 53 Hz (for 50 Hz) or between 56 and 64 Hz (for 60 Hz).
- Reference period acquisition time after contact: ≤ 500 ms (2-wire mode only).
- Reference period information retention time: 10 s (2-wire mode only).
- Measurement period acquisition time after contact and phase order display time: ≤ 500 ms.
- Phase order indication retention time: no limitations other than those of the functions of the device: switching off, reset of the function.
- Rejection of EDF remote control frames (TCC-175Hz-188Hz)

**9.3. VARIATIONS IN THE RANGE OF USE**

**9.3.1. VOLTAGE MEASUREMENT**

Quantities of influence	Limits of the range of use	Variation of the measurement	
		Typical	Maximum
Temperature	-10 ... + 55 °C	1%/10 °C ± 1 ct	2%/10 °C + 2 ct
Relative humidity	10 ... 85% RH at 45°C	2%	3% + 2 ct
Supply voltage	6.8 ... 10 V	0.5%	2% + 2 ct
Frequency	15.3 ... 450 Hz	0.5%	1%
Series mode rejection in AC	0 ... 500 Vac	50 dB	40 dB
50/60Hz series mode rejection in DC			
Common mode rejection in 50/60Hz AC			

**9.3.2. EARTH MEASUREMENT ON LIVE CIRCUIT, LOOP AND SELECTIVE EARTH**

Quantities of influence	Limits of the range of use	Variation of the measurement	
		Typical	Maximum
Temperature	-10 ... + 55 °C	1%/10 °C ± 1ct	2%/10 °C + 2 ct
Relative humidity	10 ... 85% RH at 45°C	2%	3% + 2 ct
Supply voltage	6.8 ... 10 V	0.5%	2% + 2 ct
Network frequency of the installation tested	99 to 101% of the nominal frequency	0.5% or 1 ct	1% + 1 ct
Network voltage of the installation tested	85 to 110% of the nominal frequency	0.5% or 1 ct	1% + 1 ct
Phase difference between the internal load and the measured impedance or inductance of the measured impedance or L/R ratio of the measured impedance	0 ... 20° or 0 ... 400 mH or 0 ... 500 ms	0.5%/10°	1%/10°
Resistance in series with the voltage probe (earth on live circuit only)	0 ... 15 kΩ	0.1%/kΩ	0.2%/kΩ + 1 ct
Contact voltage (U <sub>c</sub> )	0 ... 50 V	0.1%/10 V	0.2%/10 V + 1 ct

**9.3.3. TEST OF RESIDUAL CURRENT DEVICE**

Quantities of influence	Limits of the range of use	Variation of the measurement	
		Typical	Maximum
Temperature	-10 ... + 55 °C	1%/10 °C ± 1ct	2%/10 °C + 2 ct
Relative humidity	10 ... 85% RH at 45°C	2%	3% + 2 ct
Supply voltage	6.8 ... 10 V	0.5%	2% + 2 ct
Network frequency of the installation tested	99 to 101% of the nominal frequency	0.5%	1% + 1 ct
Network voltage of the installation tested	85 to 110% of the nominal frequency	0.5%	1% + 1 ct

### 9.3.4. DIRECTION OF PHASE ROTATION

No quantity of influence

### 9.3.5. CURRENT MEASUREMENT

Quantities of influence	Limits of the range of use	Variation of the measurement	
		Typical	Maximum
Temperature	-10 ... + 55 °C	1%/10 °C ± 1ct	2%/10 °C + 2 ct
Relative humidity	10 ... 85% RH at 45°C	2%	3% + 2 ct
Supply voltage	6.8 ... 10 V	0.5%	2% + 2 ct
Frequency	15.3 ... 450 Hz	0.5%	1%
Common mode rejection in 50/60Hz AC	0 ... 500 VAC	50 dB	40 dB

## 9.4. INTRINSIC UNCERTAINTY AND OPERATING UNCERTAINTY

The C.A. 6030 installation tester complies with standard IEC-61557, which requires that the operating uncertainty, called B, be less than 30%.

- In loop measurement,  $B = \pm ( |A| + 1,15 \sqrt{E_1^2 + E_2^2 + E_3^2 + E_6^2 + E_7^2 + E_8^2} )$

with  $E_1$  = influence of reference position ± 90°.  
 $E_2$  = influence of the supply voltage within the limits indicated by the manufacturer.  
 $E_3$  = influence of the temperature between 0 and 35°C.

$E_6$  = influence of the phase angle from 0 to 18°.  
 $E_7$  = influence of the network frequency from 99 to 101% of the nominal frequency.  
 $E_8$  = influence of the network voltage from 85 to 110% of the nominal voltage.

- In test of residual current device,  $B = \pm ( |A| + 1,15 \sqrt{E_1^2 + E_2^2 + E_3^2 + E_5^2 + E_8^2} )$

with  $E_5$  = influence of the resistance of the probes within the limits indicated by the manufacturer.

## 9.5. POWER SUPPLY

The device can be powered by 6 1.5-V LR6 alkaline batteries or by NiMH rechargeable batteries of the same size.

Each change of type of power supply (from batteries to rechargeable batteries or vice versa) must be indicated in SET-UP, because the low supply level is not the same, and the device might then either validate erroneous measurements or prohibit measurements because the power supply seems too low.

The supply voltage is measured regularly and displayed (  symbol). When the voltage is too low to ensure correct operation, the device displays BAAtt and switches to standby. The batteries must then be replaced.

Battery life is at least 40 hours, allowing 5 days of use at 8 hours a day.

## 9.6. ENVIRONMENTAL CONDITIONS

Indoor and outdoor use.

Operating range -10 to 55 °C and 10% to 85% RH  
 Specified operating range <sup>3</sup> 0 to 35 °C and 10% to 75% RH  
 Range in storage (sans piles) -40 °C to +70 °C and 10% to 90% RH  
 Altitude < 2,000 m  
 Pollution degree 2

7: This range corresponds to the range of the operating uncertainty defined by standard IEC-61557. When the device is used outside this range, it is necessary to add 1.5%/10°C and 1.5% between 75 and 90% RH to the operating uncertainty.

## 9.7. MECHANICAL CHARACTERISTICS

Dimensions (L x I x H) 211 x 108 x 60 mm  
Weight approximately 850 g

Protection class IP 54 per IEC 60 529  
IK 04 per IEC 50102

Free fall test per IEC 61010-1

## 9.8. CONFORMITY TO INTERNATIONAL STANDARDS

The device is in conformity with IEC 61010-1, 600V CAT III.

Assigned characteristics: measurement category III, 600V with respect to earth, 500V in differential between the terminals.

The device is in conformity with:

- IEC 61557 parts 1, 3, 6 and 7.
- IEC 61557 part 10.

## 9.9. ELECTROMAGNETIC COMPATIBILITY (EMC)

Emissions and immunity in an industrial environment per IEC61326-1.

## 10. DEFINITION OF SYMBOLS

Here is a list of the symbols used in this document and on the display unit of the device.

AC	AC (Alternating Current) signal.
DC	DC (Direct Current) signal.
Hz	Hertz: indicates the frequency of the signal.
I	current.
$I_{ALARM}$	current alarm threshold.
$I_a$	effective RCD operating current (ramp mode test).
$I_{\Delta N}$	nominal rating of the RCD tested.
$I_k$	short-circuit current between the L and N terminals.
IT	type of link to earth defined in standard IEC 60364-6.
INtP	loop or live earth measurement current.
L	L terminal (phase).
N	N terminal (neutral).
PE	PE terminal (protective conductor).
$R_{\Delta L}$	resistance of the lead on the L terminal subtracted from the measurement (compensation of measurement leads).
$R_{\Delta N}$	resistance of the lead on the N terminal subtracted from the measurement (compensation of measurement leads).
$R_{\Delta PE}$	resistance of the lead on the PE terminal subtracted from the measurement (compensation of measurement leads).
$R_A$	earth resistance in earth measurement on live circuit.
$R_{ALARM}$	loop resistance alarm threshold.
RCD	acronym designating a Residual Current Device or switch.
$R_{L-PE}$	resistance in the L-PE loop.
RMS	Root Mean Square: root-mean-square value of the signal, the square root of the mean of the squares of the signals.
$R_p$	resistance of the auxiliary rod.
$\square$	selective residual current device.
$T_a$	effective trip time of the residual current device (pulse mode test).
TN	type of link to earth defined in standard IEC 60364-6.
TT	type of link to earth defined in standard IEC 60364-6.
$U_F$	fault voltage appearing during a fault condition between accessible conducting parts (and/or external conducting parts) and the reference frame ground (IEC 61557).
$U_{Fn}$	fault voltage referred to $I_{\Delta N}$ , calculated before applying the tripping current for the test of the RCD.
$U_L$	conventional maximum contact voltage (IEC 61557).
$U_{L-N}$	voltage measured between the L and N terminals.
$U_{L-PE}$	voltage measured between the L and PE terminals.
$U_{N-PE}$	voltage measured between the N and PE terminals.
$U_p$	voltage between the PE conductor and the auxiliary rod.
$U_{REF}$	reference voltage for calculation of the short-circuit current.
$Z_{L-PE}$	impedance in the L-PE loop.
$Z_{LALARM}$	loop impedance alarm threshold.



# 11. MAINTENANCE

⚠ The manufacturer cannot be held liable for any accident that occurs following a repair not performed by its customer service department or by an approved repairer.

## 11.1. CLEANING

Disconnect the unit completely and turn the rotary switch to OFF.

Use a soft cloth, dampened with soapy water. Rinse with a damp cloth and dry rapidly with a dry cloth or forced air. Do not use alcohol, solvents, or hydrocarbons.

## 11.2. REPLACING THE BATTERIES

When there are no more bars in the battery symbol (  ), you must replace all of the batteries.

⚠ **Disconnect anything connected to the device and set the switch to OFF**, then proceed as described in §1.4.

You can use either batteries of the type indicated by the label on the battery compartment cover or NiMH rechargeable batteries having a capacity of at least 2000mAh. If this is done, it must be indicated in SET-UP (see §5.3)

When the batteries are withdrawn, enough energy is stored in the device to preserve the date and time for one minute. If this time is exceeded, the device will display tIME when next powered up, prompting you to check the date and time (see §5.2).

## 11.3. STORAGE

If the device is to be left unused for an extended period (more than two months), withdraw the batteries. The date and time will have to be set when the device is next used (see §5.2).

## 11.4. RESETTING THE DEVICE

If the device crashes, it can be reset, like a PC.

Set the switch to RCD 300mA.

Press the 3 keys indicated below simultaneously.

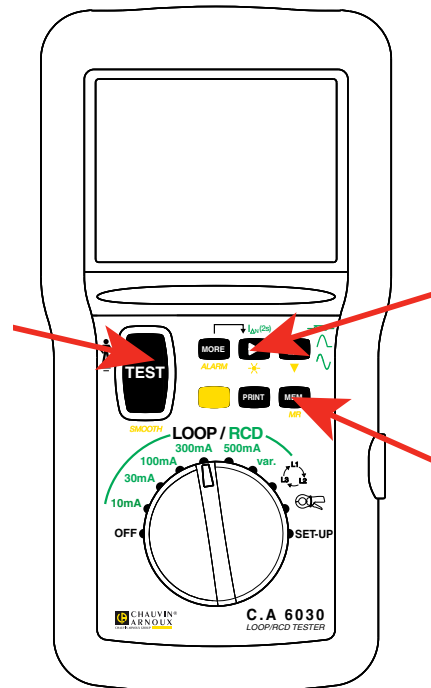
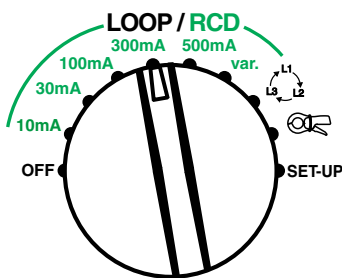

## 11.5. UPDATING OF THE INTERNAL SOFTWARE

With a view to providing, at all times, the best possible service in terms of performance and technical upgrades, Chauvin Arnoux invites you to update the embedded software of the device by downloading the new version, available free of charge on our web site.

Our site:

[www.chauvin-arnoux.com](http://www.chauvin-arnoux.com)

Click on "Support", then "Access the download area", then enter the name of the instrument.

Connect the device to your PC using the cord provided.

## 12. WARRANTY

---

Except as otherwise stated, our warranty is valid for **twelve months** starting from the date on which the equipment was sold. Extract from our General Conditions of Sale provided on request.

The warranty does not apply in the following cases:

- Inappropriate use of the equipment or use with incompatible equipment;
- Modifications made to the equipment without the explicit permission of the manufacturer's technical staff;
- Work done on the device by a person not approved by the manufacturer;
- Adaptation to a particular application not anticipated in the definition of the equipment or not indicated in the user's manual;
- Damage caused by shocks, falls, or floods.

---

**FRANCE**

**Chauvin Arnoux Group**

190, rue Championnet

75876 PARIS Cedex 18

Tél : +33 1 44 85 44 85

Fax : +33 1 46 27 73 89

[info@chauvin-arnoux.com](mailto:info@chauvin-arnoux.com)

[www.chauvin-arnoux.com](http://www.chauvin-arnoux.com)

**INTERNATIONAL**

**Chauvin Arnoux Group**

Tél : +33 1 44 85 44 38

Fax : +33 1 46 27 95 69

**Our international contacts**

[www.chauvin-arnoux.com/contacts](http://www.chauvin-arnoux.com/contacts)

