

YASKAWA

AC SERVO DRIVES Σ -7 SERIES



e-motional
solution



Certified for
ISO9001 and
ISO14001



JQA-0422



JQA-EM0202



MECHATROLINK

Σ -7 Series of AC Servo Drives

Everyone's preferred choice of Servo Drives

Since the release of the first Σ series of Servo Drives in 1992, Yaskawa Electric has consistently made innovations to existing technologies to find solutions for problems that users experience. Users have always sought high-speed, high-accuracy, and easy-to-use products, and this demand rises every year.

In 2013, the Σ series of Servo Drives evolved into the Σ -7 Servo Drives, which provides users with the ultimate experience in seven key areas and delivers the optimal solutions that only Yaskawa can offer. With the superlative performance and outstanding ease of use of the Σ -7 series, Yaskawa can offer solutions that will make the Σ -7 Servo Drives the preferred choice of customers at any point in the life cycle of their systems.



1 Ultimate system performance pages M-4 to M-7

Superlative performance with improved efficiency and speed

Attention developers/engineers

Refer to pages M-6 and M-7 for examples of the high performance of the Σ -7 series in "pick and place" applications. Contact Yaskawa for details on this and additional applications.

2 Ultimate ease of use page M-8

No tuning required with the Σ -7 series upgraded tuning-less function to achieve stable movement with no vibration.

Attention developers/engineers production maintenance personnel

You can check the level of performance of actual operations with the use of demonstration units. Contact Yaskawa for a demonstration.

3 Ultimate environmental performance page M-9

Each product has improved specifications to meet even the most stringent environmental requirements. Servo Drives can now be used in different countries and regions, and under a variety of conditions.

Attention developers/engineers operators

Are there any operating environments that you have given up on? The Σ -7 servos have an increased ability to cope with temperature rises in systems, comply with the IP67 resistance to water immersion rating, and have greater global support (AC 240 V input and operable at an altitude of 2,000 meters*). Compact and energy saving systems can also be easily built with the Σ -7W two-axis SERVOPACKS.

* At this altitude, the servo drives will operate at reduced ratings.



7 Ultimate compatibility page M-13

Programs and parameters used with Σ -V SERVOPACKs are compatible with Σ -7 SERVOPACKs. The performance of your systems can be easily enhanced with a simple replacement.

 Attention developers/engineers

There is no need to change your system design because the sizes of the Σ -V Servo Drives are the same as those of the Σ -7 series. The improved shape of the mounting screws makes them easier to secure. With the ensured compatibility of programs and parameters, it is easy to replace Σ -V Servo Drives with Σ -7 Servo Drives.



6 Ultimate lineup page M-12

You can choose from a rich product lineup of the Σ -7 series as well as from the compatible products of Yaskawa's partner companies to easily build just the right system for your needs.

 Attention developers/engineers

- Compatible products made by our partner companies are also available. You can prepare all the motion devices required for your system with our one-stop, all-in-one service.
- It is now possible to drive rotary, Linear, or Direct Drive Servomotors using the same SERVOPACK model in the Σ -7 series. This helps to reduce the number of Servo Drives that are put in storage.

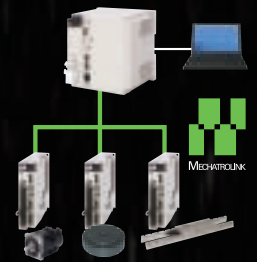

5 Ultimate support page M-11

Full support is available from selection to maintenance. Maintenance is easier because product information can be viewed by using a smartphone.

 Attention developers/engineers maintenance personnel

Services* that take full advantage of the latest technology, such as cloud storages, QR codes, and smartphones are readily available. They add another dimension of convenience and ease in terms of product information control and maintenance work.

* MechatroCloud is available in Japan only.

Note: QR code is a registered trademark of Denso Wave Incorporated.

QR code reading with a smartphone.



4 Ultimate safety and security page M-10

The Σ -7 Servo Drives satisfy the IEC 61508 safety integrity level 3 (SIL 3). Safety is also ensured with temperature sensors mounted in products. These Servo Drives can be used as system components with safety guaranteed.

 Attention developers/engineers operators maintenance personnel

It is absolutely essential to ensure the safety of systems and protect against temperature increases. The Σ -7 Servo Drives are fully equipped with all the necessary safety measures, which reduces the amount of work required for system design and maintenance.

Ultimate system performance

1

The high-performance of Σ -7 SERVOPACKs translates into ultra-high-speed and ultra-high-accuracy control, which maximizes system performance.

Σ -7S Single-axis SERVOPACKs

- ★ 3.1 kHz response frequency
- ★ Optimized for specific applications:
New models in EX and FT series to be released
- ★ Improved vibration suppression



Ripple compensation

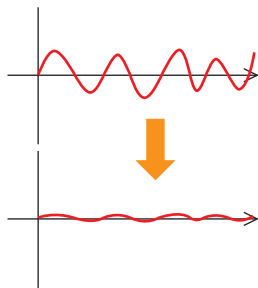

Σ -7 SERVOPACKs can reduce speed ripples caused by motor cogging, even for machines for which speed loop gains cannot be set high. This ensures smooth operation.

Enhanced vibration suppression function

Notch filter

Suppresses high-frequency vibrations of 500 Hz or higher.
Number of filters increased from 2 to 5.

Anti-resonance control

Suppresses vibrations at frequencies ranging from several hundred Hz to 1 kHz.

Vibrations can now be suppressed at multiple frequencies in comparison with one frequency in earlier models.

Vibration suppression

Suppresses vibrations at low frequencies (30 Hz and lower).

Vibrations can now be suppressed at two different frequencies (in comparison with one frequency in earlier models).

These functions can be adjusted automatically using the autotuning function.

Σ -7W Two-axis SERVOPACKs

- ★ Two-axis SERVOPACKs
(200 W x 2 axes to 1 kW x 2 axes)
- ★ 3.1 kHz response frequency
- ★ Improved vibration suppression



Σ -7C Two-axis SERVOPACKs with Built-in Controllers

- ★ 3.1 kHz response frequency
- ★ Build small-scale equipment system without PLC using one SERVOPACK.



SERVOPACK



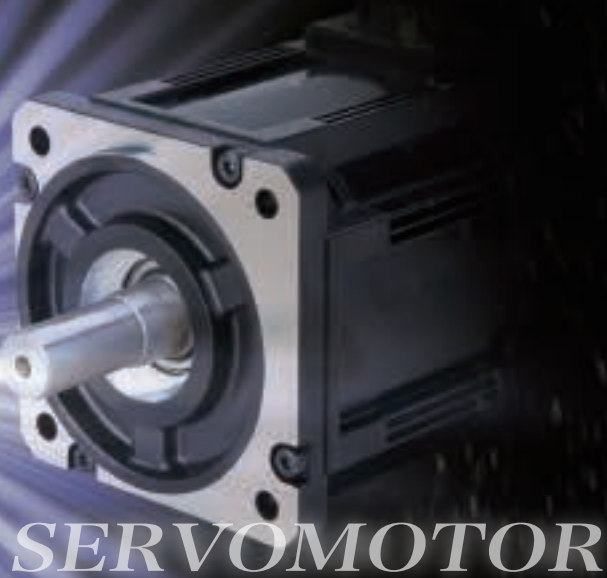

SERVOMOTOR

Model

SGMMV	10 W	30 W
SGM7J	50 W	750 W
SGM7A	50 W	7 kW
SGM7P	100 W	1.5 kW
SGM7G	300 W	15 kW



Refer to pages M-18 to M-21 for the details on the features of Direct Drive Servomotors and Linear Servomotors.



Σ -7 Rotary Servomotors

- ★ Compact dimensions
(approx. 80% smaller than our earlier models.)
- ★ High-resolution 24-bit encoder incorporated
(16,777,216 pulses/rev)
- ★ Maximum torque: 350%
(small capacity)

High-resolution, 24-bit encoder

Σ -7 Servomotors (50 W or greater) use encoders with a resolution that are 16 times higher than those used in Σ -V Servomotors.

Encoder resolution comparison

Σ -V series	Σ -7 series
20 bits =	24 bits =
1 million pulses/rev (approx.)	16 million pulses/rev (approx.)
	16 times higher!



Solution for 50-W or greater models.

Servomotors with 24-bit batteryless absolute encoders have also been added to the lineup.

High efficiency and low heat generation

Σ -7 Servomotors use an optimized magnetic circuit that improves motor efficiency and reduces heat generation.
(comparison with typical models.)

About 20% reduction in temperature increase!

(under the same conditions)

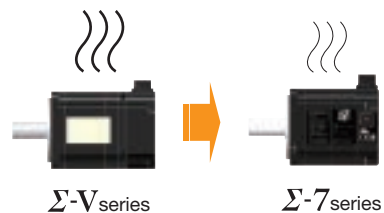

Example Solving problems in “pick and place” applications

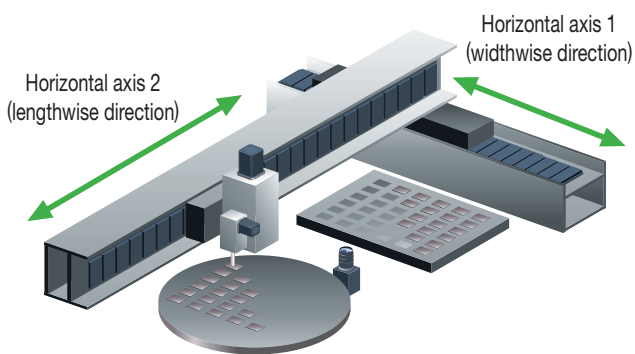

- Issue** How can we reduce takt times?
- Issue** How can we improve positioning accuracy?
- Issue** How can we suppress vibration created by speed acceleration?
- Issue** How can we achieve stable operation with or without workpieces?

“Pick and place” refers to the actions involved in picking up an object in one location and placing it in another location.

Issue 1 We need to reduce takt times.

Problem

Case 1

Vibration occurs after servo gain is increased.

Without anti-resonance control adjustment

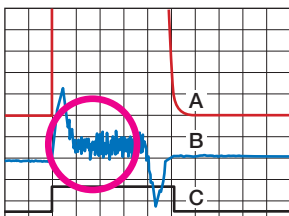

A Position deviation
B Torque reference
C Positioning Completion signal

Case 2

Servo gain was successfully increased by first using the anti-resonance control adjustment, and then vibration occurred at a different frequency.

With anti-resonance control adjustment

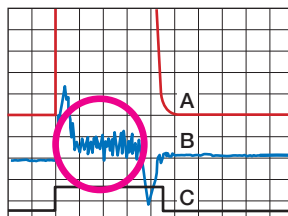

Solution

Servo gain can be increased by using the enhanced anti-resonance control adjustment function.

With improved anti-resonance control adjustment

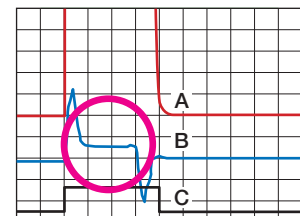

Reduces system takt times

Issue 1 We want to increase productivity by suppressing vibration of equipment.

Problem

Vibration occurs at two different frequencies at the edges of equipment and it takes a while for the vibration to stop.

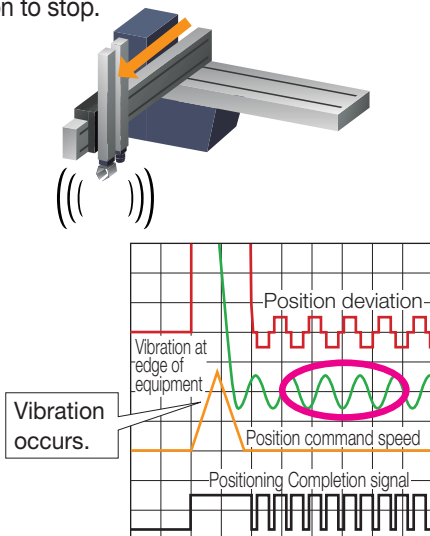

Solution

Vibration at two different low-frequencies is suppressed simultaneously with the automatic adjustment function.

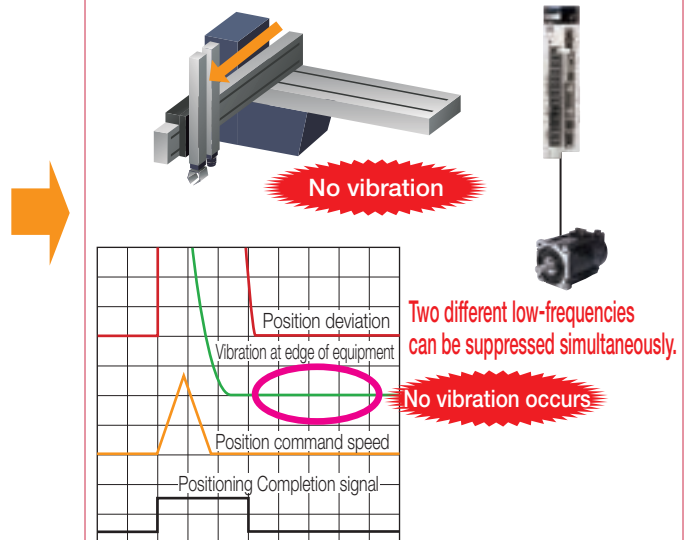

Issue 2 We want to improve positioning accuracy to handle parts that are becoming increasingly smaller.

Problem

Positioning accuracy needs to be improved because parts that are handled are becoming increasingly smaller.

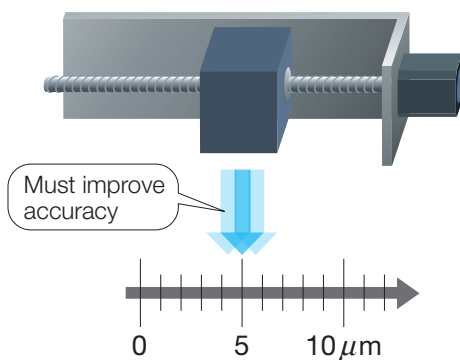

Solution

High-precision positioning becomes possible for precision workpieces by replacing the existing drive with the Σ -7 Servo Drive.

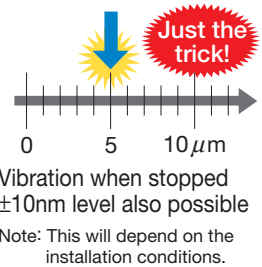

Σ -7S SERVOPACKs

- Highest performance in the industry
- 3.1 kHz response frequency
- Improved vibration suppression

Σ -7 Servomotors

- High-resolution encoders
24 bits = 16,777,216 pulses/rev
- For 20 mm lead ball screws
1.2 nm resolution



2

Ultimate ease of use

Yaskawa's original tuning-less function has undergone further development. Stable operations can be achieved without having to adjust gains.

No need to adjust servo gains

With Yaskawa's original tuning-less function, systems can run without vibration for a load with 30 times (max.) of load moment of inertia. Systems remain stable even with load changes during operation.

	Σ -V Series	Σ -7 Series
Allowable load moment of inertia ratio	30 times (max.)	30 times (max.)
Max. control gain	Speed loop gain 40 Hz (approx.)	Speed loop gain 70 Hz (approx.)

When the allowable load moment of inertia ratio is 30 times:

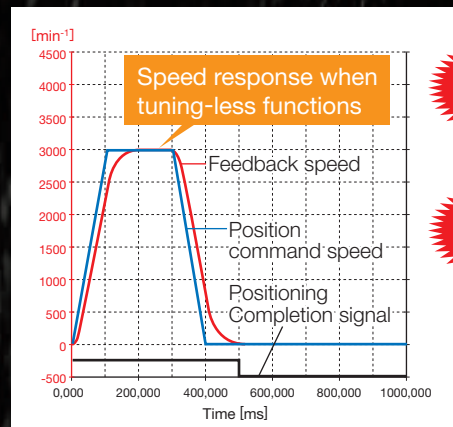
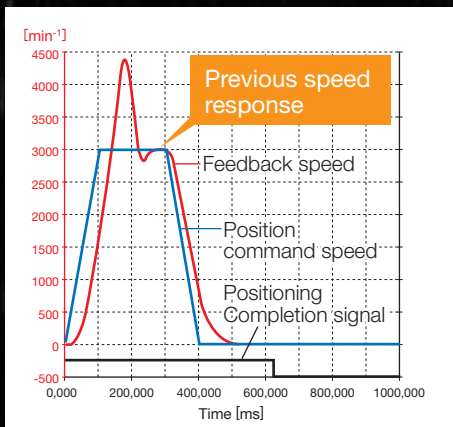

Setup time reduced

Takt time reduced

Solution Example Robot

The robot's arm maintains stable movements even when the moment of inertia changes due to changes in the robot's posture.

- **Improved response**
Response is about twice as fast as before and requires no adjustment.
- **Improved stability**
Stable operation is assured even in systems with load fluctuations.
- **No need for gain adjustments**
High-level performance is assured although no tuning is required.

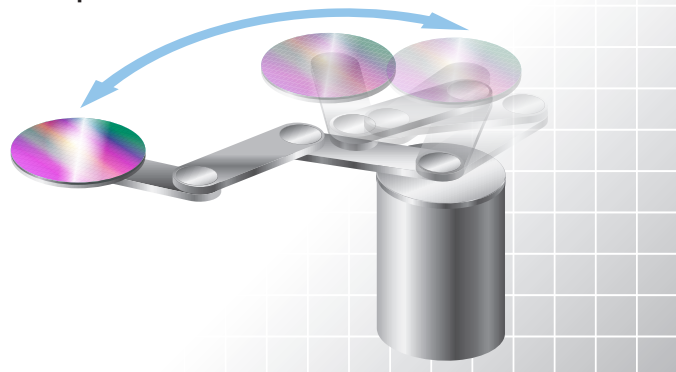

3

Ultimate environmental performance

e-motional
solution

The Σ -7 Servo Drives can be used in harsh environments and conserve energy. Optimal systems can be easily set up in different countries and under a variety of conditions.

Satisfies specifications for use overseas and in harsh operating conditions

- 240 VAC supply voltage also supported
- High-altitude use increased to 2,000 meters above sea level*
- Maximum ambient temperature raised to 60°C*

* Derating required.

Waterproof protective structure upgrade to IP67 rating

[SGM7J, SGM7A (IP22 for 7.0 kW), and SGM7G models]

Protective Structure (IEC 60034-5)

IP 67

◎ Rating for protection from water:

The units can be used even when they are immersed in water under specific conditions (immersed at a depth of 1 m below the surface of the water for 30 minutes).

◎ Rating for protection from contact and entry of solid foreign objects:

Safe dust-proof structure

Structure is completely protected from the entry of dust.

Solution Example

Regenerative energy effectively used to help save energy

Issue

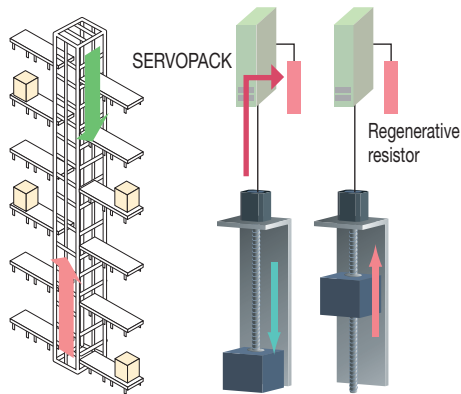

Regenerative power used to be converted to heat by using regenerative resistors. With global warming, CO₂ emissions must be cut by reducing power generation that produces CO₂, such as thermal power.

Solution

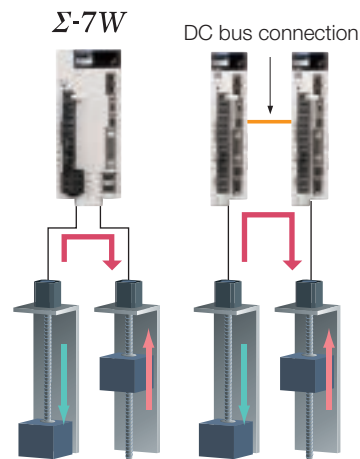

- By replacing the existing amplifiers with the Σ -7W 2-axis SERVOPACKs or using a DC bus connection, the regenerative energy of multiple axes can be used as the drive energy.
- This means that the energy inside the system can be utilized more effectively.
- Status of energy consumption in the system can be viewed on a display by using machine controllers.



Energy consumption monitoring display (image)

4

Ultimate safety and security

Systems can be operated safely because the Σ -7 Servo Drives comply with safety standards and safety is ensured by monitoring.

Satisfies requirements of the SIL 3 of the IEC 61508 functional safety standards (first in Japan)

Certification will make it easier to set up systems that conform to safety standards for press machines and other systems in Europe and other regions. Certification also helps reduce the number of hours required for wiring and of peripheral devices. **Complies with Stop Category 0 (Safe Torque Off)**

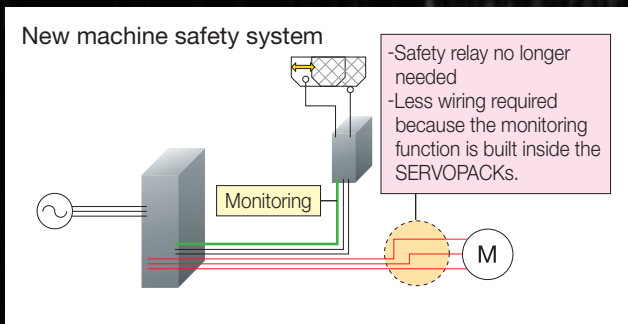
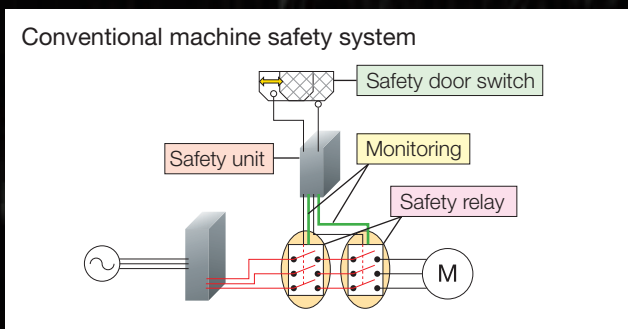

	Safety standards	Performance level & category
Safety of machinery	EN ISO13849-1	PLe (CAT3)
	IEC 60204-1	Stop Category 0
Functional safety	IEC 61508	SIL 3
	IEC 62061	SIL CL3
	IEC 61800-5-2	STO

- The safety function works even for a single problem.
- The safety function is enhanced with compliance with the EN ISO 13849-1 PLe (performance level e).

Note: Although the safety performance level of the Σ -V series Servo Drives is PLd (performance level d), the benefits described in the figure on the left apply.

Systems that need to satisfy the required performance level e (PLr e) can easily be configured.

Protect systems from high temperatures

Σ -7 SERVOPACKs and Servomotors are equipped with temperature sensors that can directly monitor temperatures of machines and detect abnormalities to prevent failures. Real-time temperatures can be viewed on a display by using Machine Controllers.

Protection from abnormal temperatures

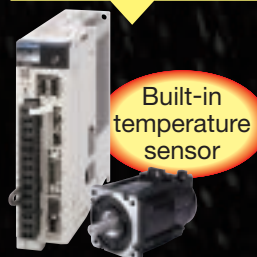

Temperature monitoring display (image)

Maintenance throughout a product's service life is improved and simplified with SigmaTouch!, Yaskawa's smartphone application.

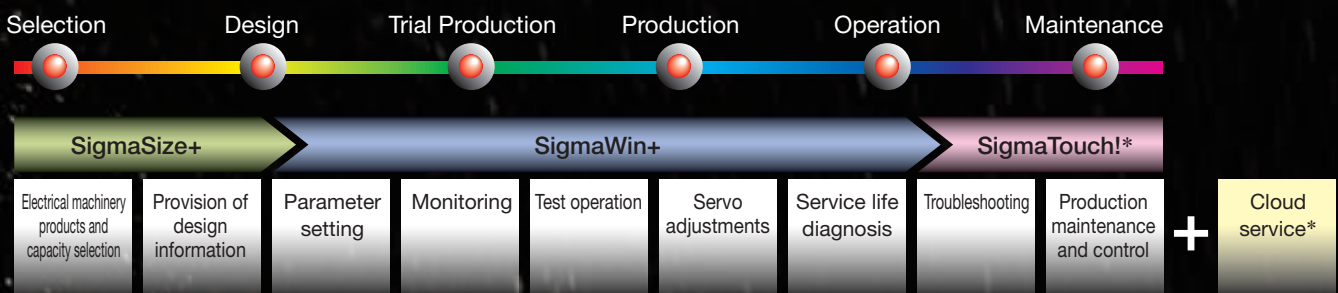

Single or multiple orders possible after specifying parameters*

Customers can now place single or multiple orders for SERVOPACKs in the Σ -7 series after specifying parameters at the factory shipment stage. No longer is it necessary to write the parameters at the system assembly site, which means that production lead times can be reduced.



Note: MechatroCloud is available in Japan only.

Product management and maintenance service*

Product information can be easily viewed by using SigmaTouch!, Yaskawa's smartphone application. To view, simply hold your smartphone over the QR code of the product.



Improve troubleshooting*

- If you have a smartphone, troubleshooting information can be accessed by reading a product's QR code.
- Automatic tracing is possible when a SERVOPACK alarm occurs. This allows you to detect and solve problems promptly.

Features:
Simply access the MechatroCloud service* and hold your smartphone over the QR code of the product. You can access the product data stored in the MechatroCloud, and view the manual for that product.

Note: MechatroCloud is a new cloud service provided by the Yaskawa Electric.

Achieve planned maintenance by monitoring the remaining service life

The service life of the maintenance can be estimated, and the users are notified when the parts should be replaced. System failure can be prevented because parts can be replaced before products break.

Service Life Monitor

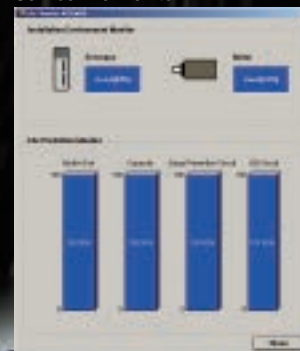

* MechatroCloud is available in Japan only. For details, refer to pages M-14 to M-19.

6



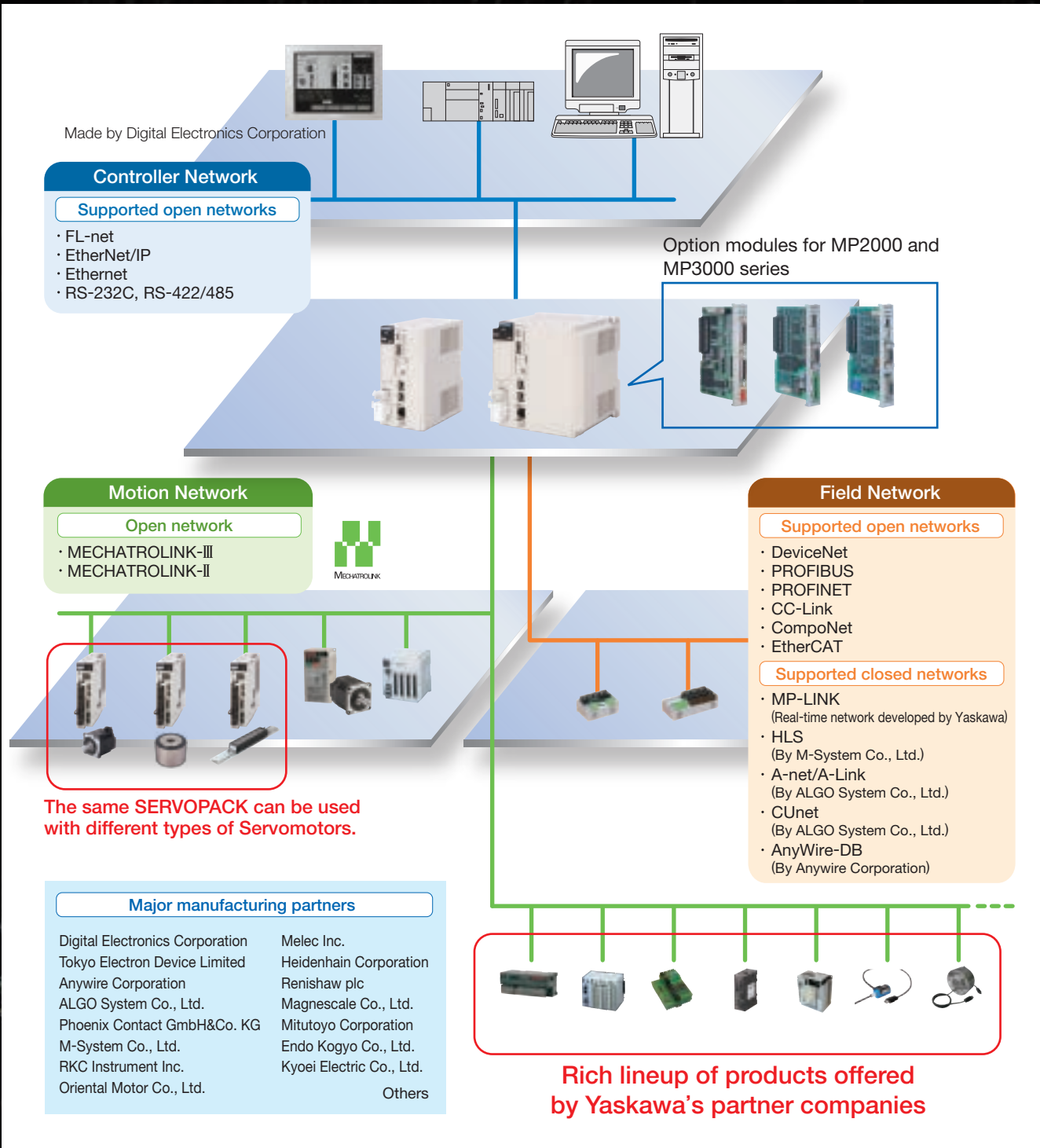

Ultimate lineup

You can construct a system that exactly meets your requirements using communications networks and the rich lineup of products offered by Yaskawa's partner companies.

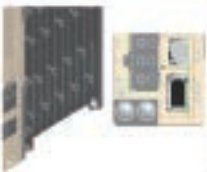
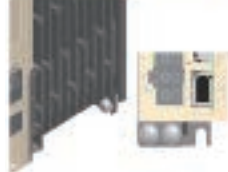
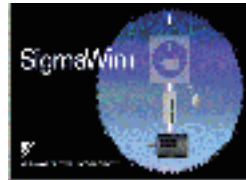

7

Compatibility with earlier series is assured. You can improve the performance of your system by replacing devices currently used with Σ -7 Servo Drives.

SERVOPACK	<p>Installation interchangeability with the models in the Σ-V SERVOPACK having the same capacity is featured for the SERVOPACKs.</p> <p>The Σ-7 SERVOPACKs have improved shapes for mounting holes. With this new shape, it is much easier to insert a screwdriver.</p>	<p>A parameter conversion mode is provided. The parameters of the Σ-V SERVOPACKs can be used with the Σ-7 SERVOPACKs, when using the SigmaWin+ parameter converter.</p>
	<div style="display: flex; justify-content: space-around;"> <div style="text-align: center;"> <p>Mounting holes on Σ-V top</p>  </div> <div style="text-align: center;"> <p>Mounting holes on Σ-7 top</p>  </div> </div> <div style="display: flex; justify-content: space-around; margin-top: 10px;"> <div style="text-align: center;"> <p>Mounting holes on Σ-V bottom</p>  </div> <div style="text-align: center;"> <p>Mounting holes on Σ-7 bottom</p>  </div> </div>	
Servomotor	<p>The Σ-7 SERVOPACKs are compatible with models of the same capacity in the Σ-V series SERVOPACKs.</p> <div style="display: flex; align-items: center; justify-content: center; margin: 10px 0;"> <div style="text-align: center;"> <p>Σ-V</p>  <p>200 W □60 mm</p> </div> <div style="margin: 0 20px; font-size: 2em; color: orange;">➔</div> <div style="text-align: center;"> <p>Σ-7</p>  <p>200 W □60 mm</p> </div> </div>	

MechatroCloud is a cloud service offered by the Motion Control Division of Yaskawa Electric. With this service, it is now easier and more convenient to use Yaskawa's motion control products. A wide range of services are now available through Yaskawa's website, smartphone applications, and QR codes.

Troubleshooting
SigmaTouch!
smartphone application



BTO Service
Website



BTO Service

You can order customized SERVOPACKs from the website!

Use BTO
for
free!

Customize parameter settings

Parameters and text to be printed on nameplates can be registered on the MechatroCloud website. This service is available for all orders.

Reduce equipment assembly time

Ready-to-use SERVOPACKs will be delivered to you with parameters set and text printed on the nameplate.

Refer to page M-16 for an example of how BTO can be used.



In the BTO (build to order) service available from Yaskawa, parameters for SERVOPACKs are set to the values specified by customers when placing orders. Customers can order customized SERVOPACKs by simply registering parameter specifications on the website.

Standard product Parameter file specified by customer*1 BTO product



Parameter values are set to customer specifications.

Text*2, such as "Axis name", can be printed on the nameplate.

Note: To use MechatroCloud service, you must register your name under the corporate membership of the e-mechatronics website, the Yaskawa Electric website for product and technical information.

*1. Use a parameter file for version 5.71 or later versions of SigmaWin+.

*2. Alphanumeric characters and some symbols can be used for the text (equipment name and axis name).

MechatCloud Introduction Videos – Now on YouTube

Use the standard bar code reader on your smartphone to read these codes and view videos on YouTube.

Note: "YouTube" is a trademark or a registered trademark of Google Inc.

BTO service



SigmaTouch!



BTO Service

Single or multiple orders possible after specifying parameters (BTO)

Customers can now place single or multiple orders for SERVOPACKs in the Σ -7 series after specifying parameters at the factory shipment stage. It is no longer necessary to write the parameters at the system assembly site, which means that production lead times can be reduced.

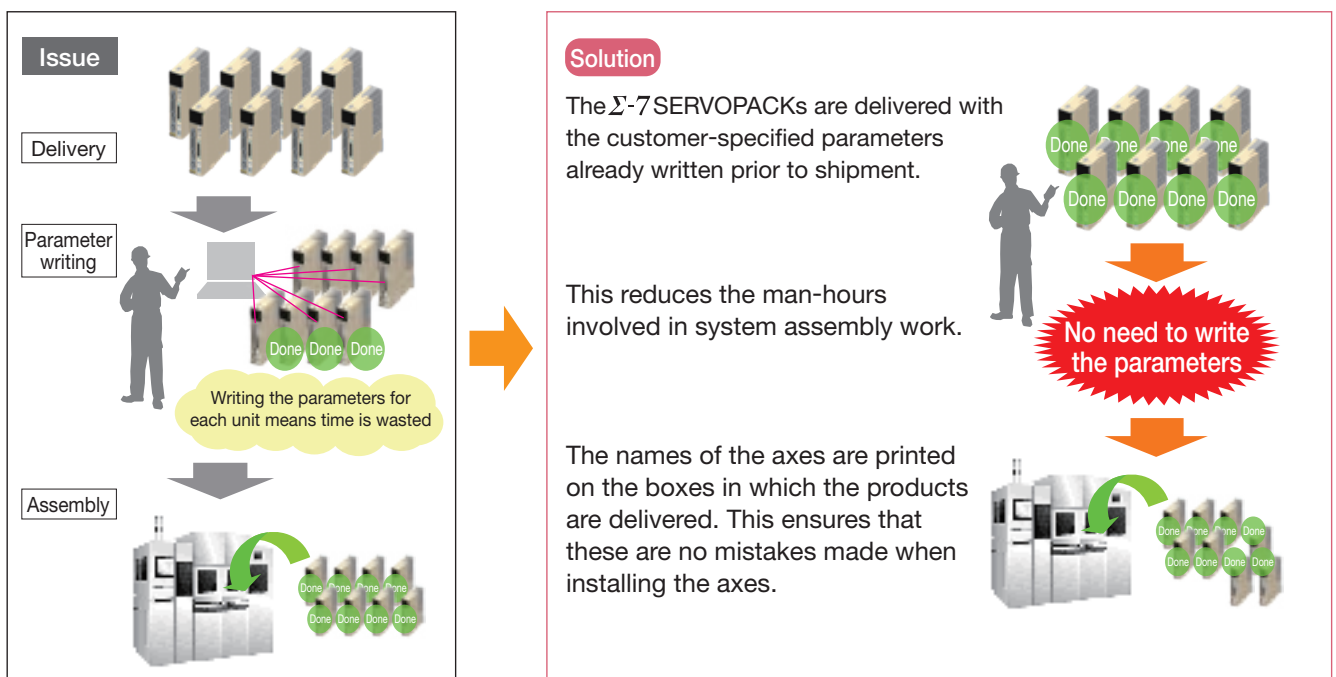

BTO Service

How to use Yaskawa's BTO service

- ① Register required information under a corporate membership on the e-mechatronics website.*
- ② Determine parameters for your equipment.
- ③ Upload the parameter file to the MechatroCloud website and issue BTO numbers and BTO order numbers.

Note: Use a parameter file for SigmaWin+ version 5.71 or later versions to upload parameter files.

- ④ Provide the BTO order number to your Yaskawa representative when requesting estimates and placing orders.

* Corporate member registration for MechatroCloud use

Corporate Members



Corporate Manager

Management Group

The Corporate Manager is in charge of the members that are registered under the company's corporate membership. The first person who registers as a corporate member is the Corporate Manager. There must be at least one Corporate Manager for each corporate membership.

● **Corporate Managers are authorized to:**

- Add or delete Corporate Managers or Corporate Users.
- Issue or delete BTO numbers.

Corporate User (company employees)

Corporate User group

A person who is added as a corporate member by the Corporate Manager.

● **Corporate Users (company employees) are authorized to:**

- Issue or delete BTO numbers.



Corporate User (system integrators)

A person who is added as a corporate member by the Corporate Manager.

● **Corporate users (system integrators) are authorized to:**

- Issue or delete BTO numbers.

Corporate User (sales representatives)

A person who is added as a corporate member by the Corporate Manager.

● **Corporate Users (sales representatives) are authorized to:**

- Issue or delete BTO numbers.

Register required information under the corporate membership of the e-mechatronics website, the Yaskawa Electric website for product and technical information. For example, information on Yaskawa's BTO service can be shared by members of the same corporate membership by registering persons at the same company and/or persons at related companies under the same corporate membership.

There are two types of corporate membership: Corporate Manager and Corporate User.

The member(s) in charge of Corporate Members is called the Corporate Manager. The Corporate Manager is the first person to register as a Corporate Member. Persons who are invited to become Corporate Members under the same corporate membership are called "Corporate Users." A Corporate User can issue BTO numbers.

Easy troubleshooting with SigmaTouch!

Anytime, Anywhere

Use SigmaTouch! for free!

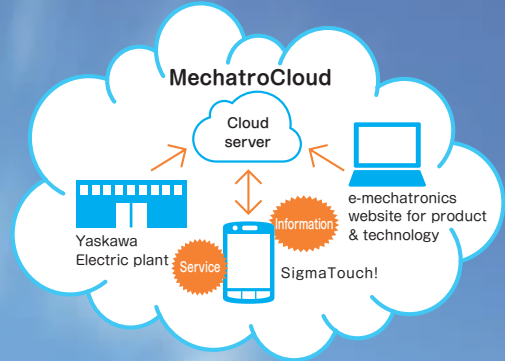

Innovative service that links users to cloud data!

Yaskawa is striving to incorporate the needs of our customers into our services in a timely manner. With the use of SigmaTouch!, users can quickly and easily access the MechatroCloud server, which contains the latest product information from Yaskawa Electric's plants and maintenance information from the e-mechatronics website. Yaskawa Electric's service will continue to be enhanced to accommodate the needs and expectations of our customers.

Easily search for product information using SigmaTouch!

Users can search for troubleshooting information for a specific model and view product manuals on a smartphone by using a smartphone camera to simply read the QR code of the product.

Simply read the QR code!



"SigmaTouch!" is a smartphone application for MechatroCloud. Product information, such as manufacturing information and parameter lists, can be viewed by simply reading the QR codes of Yaskawa Electric's products with a smartphone camera. Alarm details and troubleshooting information can also be viewed on the smartphone, which can greatly reduce recovery time.

Note: The QR codes can be read with Android OS 4.0.3 or later versions. The Android must be connected to the network to use this service.



QR code



SigmaTouch!

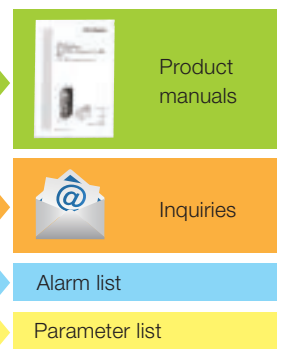

etc.

SigmaTouch!

Easier and faster troubleshooting options

Operators can use smartphones on-site to display the SERVOPACKs in the Σ -7 series manual and troubleshooting details. The trace waveforms generated when alarms occur can be saved automatically, and the real causes of problems can be tracked faster, which reduces downtime.

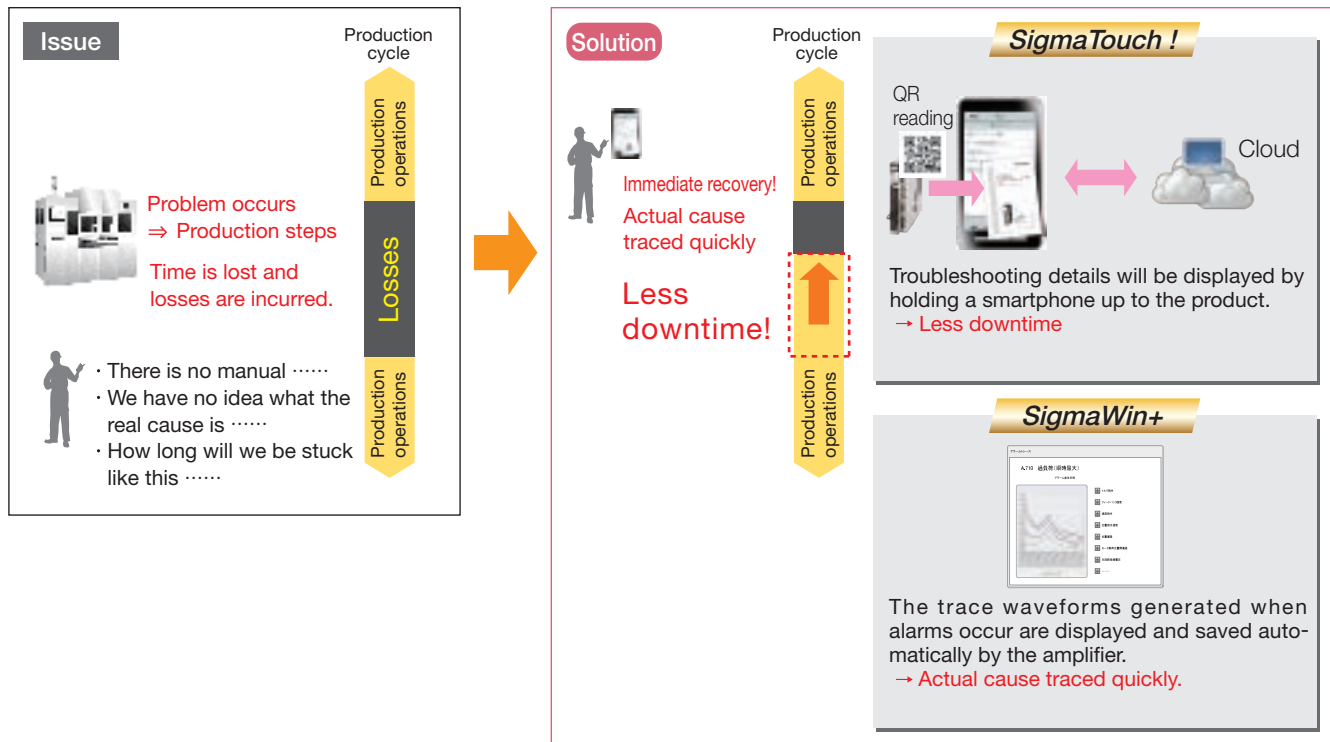

Napping on the Cloud Narumi

An alarm is going off!
What should I do?

All you need is a smartphone.

At the customer's plant

Details of the alarm can be found in seconds.

Search Alarms

A.720

Search

It's so easy to see what the problem is and how to solve it.

Note: The smartphone screen is a sample illustration.

You can also view manufacturing information for the product by reading the QR code.

I can view manuals too.

Display Manual

Note: The smartphone screen is a sample illustration.

Thank you! Now I can restart the production line.

You can fix the problem quickly on site.

At the customer's plant

SigmaTouch!

Functions of SigmaTouch!

Members of the e-mechatronics website have immediate access to all functions. (Non-members can access some functions.)

- ◎ : Can use all functions and view information of BTO products.
- : Can use all functions.
- △ : Can view some information.

	Corporate members	Individual members	Non-members
Product information	◎	●	△ Nameplate info only
Manuals	●	●	
Troubleshooting	●	●	

Easy download from the Google Play Store

SigmaTouch! can be downloaded from Google Play Store, the contents distribution service for Android.

You can access the Google Play Store through the e-mechatronics website, the Yaskawa Electric website for product and technical information.

Download SigmaTouch! to your smartphone to start your experience!

Note: "Android" and "Google Play" are trademarks or registered trademarks of Google Inc.

Download SigmaTouch!
from the Google Play Store for free.



Link to the Google Play Store →
Read the QR code with the bar
code reader of your smartphone.



Use the various functions and services of SigmaTouch! using your smartphone.



Select the
appropriate
function.



Read the QR code
on the SERVOPACK.*

* Hold the camera about 10 cm
away from the QR code.

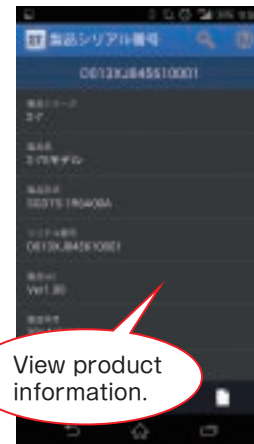

View product
information.

Direct Drive Servomotors

Use a direct drive to supply high torque at low speeds, obtain precise positioning at high speeds without any slippage and backlash, and simplify your machine's configuration and maintenance.



Features

Coreless, inner rotor
Small capacity: SGM7E/SGMCS*1

Ideal for applications that require smooth movement without speed fluctuations.

With core, inner rotor
Small capacity: SGM7F/SGMCV*2
Medium capacity: SGM7F/SGMCS*2

Ideal for applications that require downsizing and a shorter takt time.

With core, outer rotor
Small and medium capacity: SGM7D

Ideal for applications that require high torque, high precision, and high rigidity.

Structures

Inner rotor

The inside of the motor rotates.



- ⊙ Built-in 24- and 20-bit encoder.
- ⊙ Low cogging with a core-less system provides smooth operation free from speed variations.

Inner rotor

The inside of the motor rotates.



- ⊙ Built-in 24-, 22- and 20-bit encoder.
- ⊙ Compact design with small rotor diameter.
- ⊙ High-speed, high-frequency positioning.
- ⊙ Low inertia.
- ⊙ Low heat generation.

Outer rotor*3

The outside of the motor rotates.



Compatible with the former Yokogawa Electric DYNASERV Series.

- ⊙ Built-in 24-bit encoder.
- ⊙ Application to large loads possible with a high allowable load moment of inertia ratio.
- ⊙ Large center aperture design provides more space available for wiring connections.
- ⊙ High rigidity.

*1: The SGM7E is the next-generation series following the SGMCS (Small capacity).

*2: The SGM7F is the next-generation series following the SGMCV and SGMCS (Medium capacity).

*3: A magnetic bias is used that places a strong permanent magnet between the stator and core.
Note: Use the motor with a Σ -7S SERVOPACK that has a FT82/FT83 specification.

Applications

- ⊙ Spinning (CMP equipment and washing machines)
- ⊙ Printing rolls



- ⊙ Indexers
- ⊙ Sorters and bonders



- ⊙ Rotary tables (Can handle large loads.)
- ⊙ Semiconductor manufacturing equipment
- ⊙ Machine tools

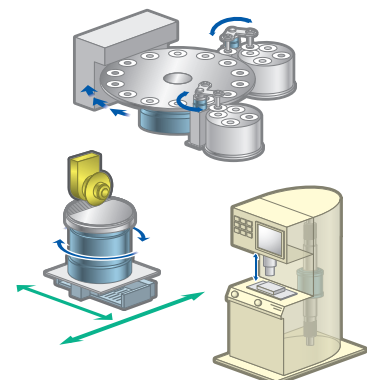

Features of Direct Drive Servomotor

The load is mounted directly to the motor, so the motor accuracy becomes the equipment accuracy, which contributes greatly to increasing the equipment accuracy. Furthermore, there is no drop in efficiency due to the presence of a reduction gear or other parts, which helps to save energy. The motor's compact size also enables reducing the equipment size, which helps to reduce both the design process time and maintenance costs. The desired operation angle and number of divisions can easily be set, simply by changing the command values.

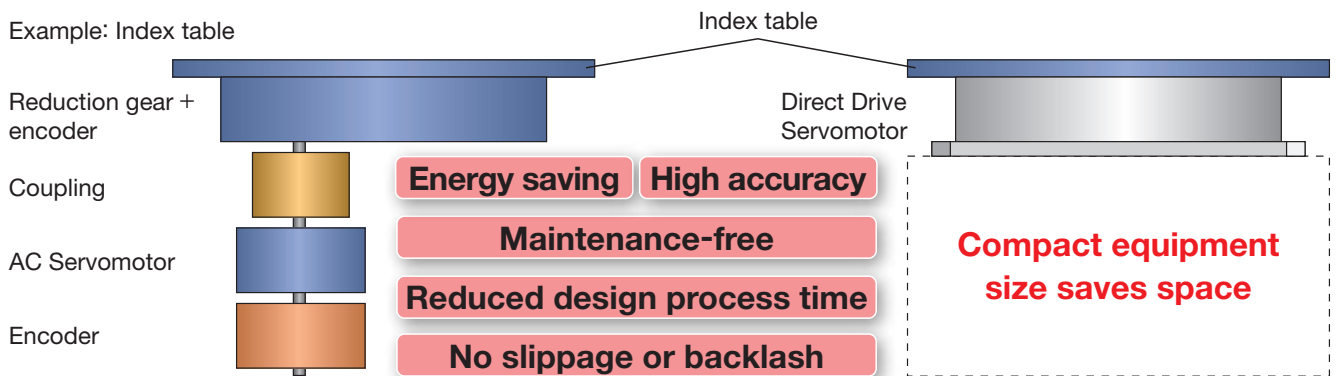
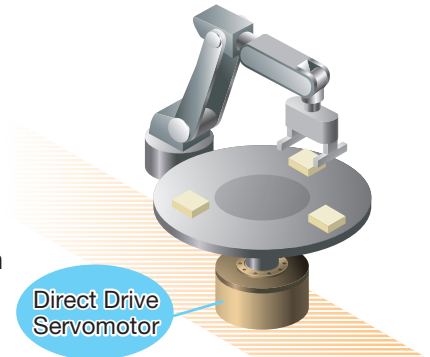

Typical Servo Drive System

Current limitations :

- Reduced accuracy in positioning with excessive slippage and backlash
- Noise
- Maintenance for wear and tear or for lubrication

Motor with Gear

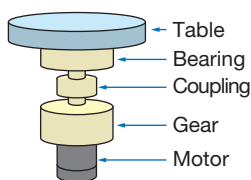

Motor + Timing Belt

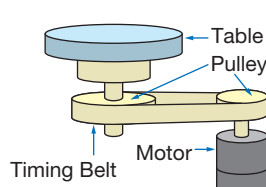

Hollow Motor + Hollow Gear

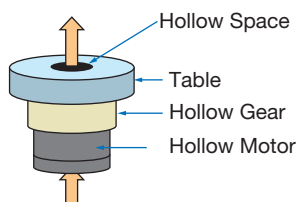

Direct Drive System

Technical improvements:

- Improved positioning accuracy with direct connection to a load
- Low noise
- Clean room use (No gear means no lubrication.)
- Reduced number of parts
- Easy wiring and piping based on the motor's hollow design

Direct Drive Servomotor

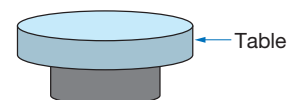

Direct Drive Servomotor (Large center aperture)

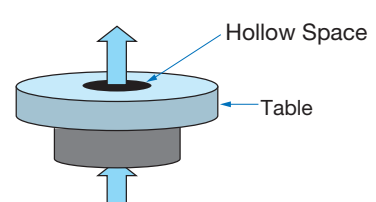

Linear Servomotors

Linear Servo Drives contribute to improved machine functionality and performance with exceptional features such as high speed, fast acceleration, long-stroke compatible, constant speed, stability, clean operation, low noise, and low maintenance.

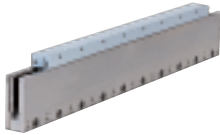

Coreless Model
(SGLG)

The lack of magnetic attraction force helps to extend the life of the linear motion guides and minimize operational noise in applications that require high precision with a small force.

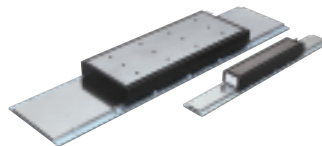

Model with F-type Iron Cores
(SGLF)

The compact profiles of the FW Linear Motors save installation space. The magnetic attraction between the Moving Coil and Magnetic Way allows the linear motion guides to be highly rigid.

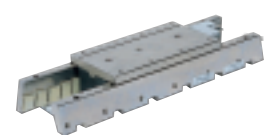

Model with T-type Iron Cores
(SGLT)

Yaskawa's unique structure negates the effects of magnetic attraction. This reduces concerns for the structural strength of the linear motion guides and machinery.

Features

Structures

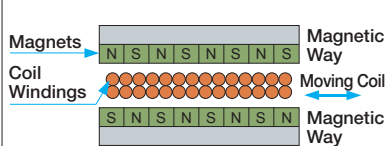
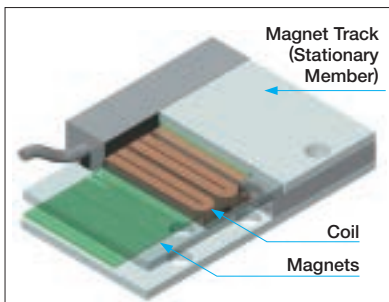

- The Moving Coil has no core, and is made of accurately molded resin windings
- The Magnetic Way is made of two facing plates with accurately placed magnets secured on the sides.

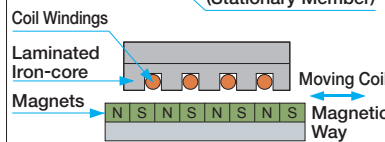
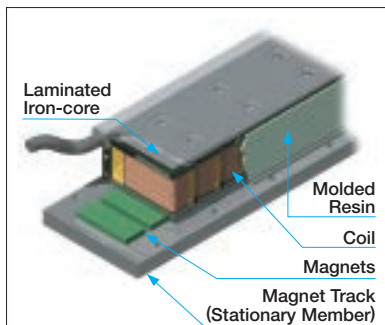

- The Moving Coil consists of laminated core and pre-wound coil bobbins inserted into slots located in the laminated core and encapsulated in resin.
- The Magnetic Way is made of a row of magnets accurately placed on the core side of the carrier plate.

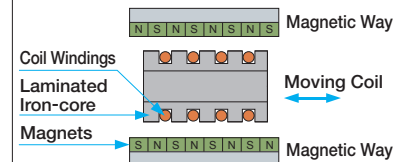
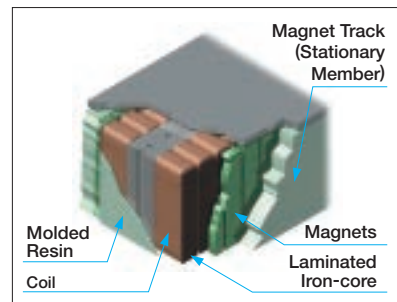

- The Moving Coil consists of laminated core and pre-wound coil bobbins inserted into slots located in the laminated core and encapsulated in resin.
- The Magnetic Way is made of a row of magnets accurately placed on carrier plates on both sides of the core.

Applications

◎ **Multiple heads**

Devices used in LCD and OLED manufacturing (dispensers, inspection equipment, repair equipment, etc.)

◎ **Linear stages (X, Y, θ)**

Devices used in LCD and OLED manufacturing (for G5.5 or larger glass substrates and for long strokes) and semiconductor manufacturing devices (probers, etc.)

◎ **Gantries**

Devices for electronic parts manufacturing (high-speed chip mounters, etc.)

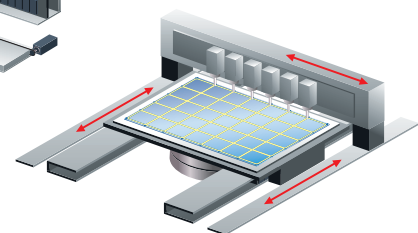
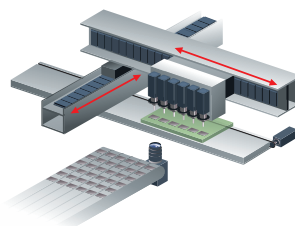

Benefits of Linear Servomotors

Linear Drive

Benefits 1

- High Speed
- High Precision

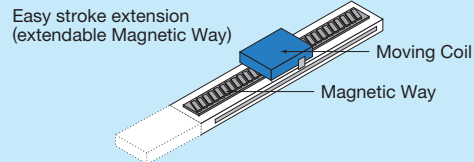

Speed	A load is directly driven by the Linear Servomotor without any restrictions on the speed. This easily enables speeds of up to 5 m/s.
Positioning Accuracy	The load is directly driven in a fully-closed loop, enabling submicron positioning control at the sensor resolution.
Stroke	A long stroke can be achieved by coupling Magnetic Ways as required.

Ball Screw Drive

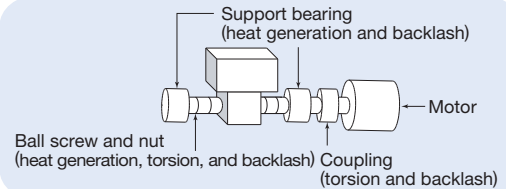

Resonance and heat generation occur at high speeds.

The actual position is likely to deviate from the target position due to torsion and backlash.

A ball screw must be selected according to the stroke length.

Benefits 2

- Fast Acceleration
- Simple Structure

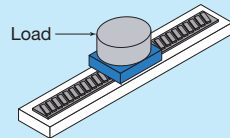

Acceleration Rate	$\text{Acceleration rate} = \frac{\text{Force}}{M+m} \left(\begin{array}{l} M = \text{Load mass} \\ m = \text{Moving Coil mass} \end{array} \right)$
--------------------------	---

The acceleration rate can be increased just by lightening the load.

Heat Generation	Extremely limited heat transfer to the surroundings allows highly accurate positioning.
------------------------	---

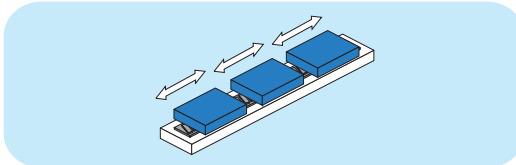

Extendibility	<p>Multiple Moving Coil can be mounted to one Magnetic Way.</p> <p>↓</p> <ul style="list-style-type: none"> Simple structure. Versatile operations can be performed on the same axis.
----------------------	--

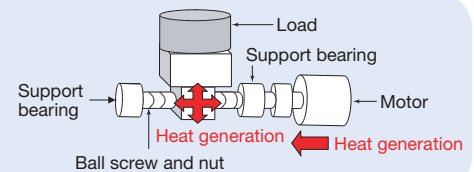

Acceleration rate	$\text{Acceleration rate} = \frac{\text{Torque}}{J_L + J_B + J_C + J_M} \left(\begin{array}{l} J_L = \text{Load inertia} \\ J_B = \text{Ball screw inertia} \\ J_C = \text{Coupling inertia} \\ J_M = \text{Motor inertia} \end{array} \right)$
--------------------------	--

Lightening the load does not have much impact on increasing the acceleration rate.

The ball screw expands due to the heat generated at different parts, resulting in inconsistent positioning accuracy.

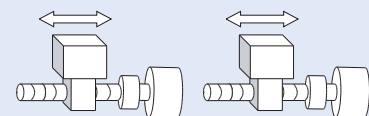

	<p>Multiple feeding units are required to perform versatile operations on the same axis.</p> <p>↓</p> <ul style="list-style-type: none"> Increased costs. One ball screw can be used for only one operation.
--	--

Benefits 3

- Easy Operation

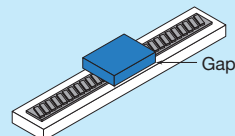

Noise	A table that uses a Linear Servomotor has limited mechanical contact areas and therefore creates minimum operational noise.
Maintenance	A table that uses a Linear Servomotor has limited mechanical contact areas, which greatly reduces the need for maintenance.
Clean Environment	The lack of any rotating parts creates a clean manufacturing environment without grease splattering.

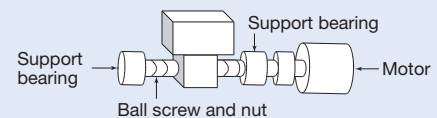

High-speed operation is likely to increase noise.

The many mechanical contact areas require periodic maintenance to be performed for lubrication and wear.

Rotating contact areas cause applied grease to splatter, making it difficult to keep a clean manufacturing environment.

Σ-7-Series SERVOPACKs and Option Modules

SERVOPACKs

MECHATROLINK-III/-II Communications Reference

◎ Real-time communication

A high transmission speed allows real-time transmission of various data required for control.

◎ Cost savings

Multiple stations can be connected to a single MECHATROLINK transmission line, so wiring costs and time are greatly reduced. Also, only one signal connector is required on the host controller. The all-digital network eliminates the need for a converter to change speed/torque references from digital to analog and for a pulse generator to create position references.

◎ High-precision motion control

The SERVOPACK when connected to the host controller in the MECHATROLINK-III /-II network provides not only torque, position, and speed control, but also synchronized phase control that requires advanced control technology. The control mode can be changed online so that the machine can move smoothly in complex motions with great efficiency.



Single-axis
MECHATROLINK-III
Communications
Reference Σ-7S



Two-axis
MECHATROLINK-III
Communications
Reference Σ-7W



Single-axis
MECHATROLINK-II
Communications
Reference Σ-7S



Analog Voltage/
Pulse Train
Reference Σ-7S

Communications protocol	MECHATROLINK-III	MECHATROLINK-II
Physical layer	Ethernet	Same as RS-485
Baud rate	100 Mbps	10 Mbps
Transmission cycle	Σ-7S: 125 μs to 4.0 ms, Σ-7W: 250 μs to 4.0 ms	250 μs to 4.0 ms
Number of transmission bytes	32 or 48 bytes/station	17 or 32 bytes/station
Number of slaves	62 max.	30 max.
Maximum transmission distance	75 m between stations	50 m total (100 m with Repeater)
Minimum distance between stations	20 cm	50 cm

Analog Voltage/Pulse Train Reference

Analog voltage reference	Speed control	Reference voltage	Max. input voltage	± 12 V (forward speed reference with positive reference)
			Factory setting	6 VDC at rated speed (Input gain setting can be changed.)
Torque control	Reference voltage	Max. input voltage	± 12 V (forward torque reference with positive reference)	
		Factory setting	3 VDC at rated torque (Input gain setting can be changed.)	
Pulse train reference	Position control	Reference pulse	Type	Select one: Sign + pulse train, CW + CCW pulse train, or two-phase pulse train with 90° phase differential
			Form	For line driver, open collector
			Max. input pulse frequency*	Line driver Sign + pulse train, CW + CCW pulse train: 4 Mpps Two-phase pulse train with 90° phase differential: 1 Mpps
	Open Collector	Sign + pulse train, CW + CCW pulse train: 200 kpps Two-phase pulse train with 90° phase differential: 200 kpps		
Clear signal (Position error clear)		For line driver, open collector		

*: If the maximum reference frequency exceeds 1 Mpps, use a shielded cable for I/O signals and ground both ends of the shield. Connect the shield at the SERVOPACK to the connector shell.

INDEXER Module-Mounted Type

Application Examples

Point-to-point positioning
(X-Y Table)

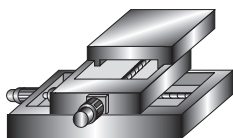

Station positioning (Indexing)
(Rotary Table)

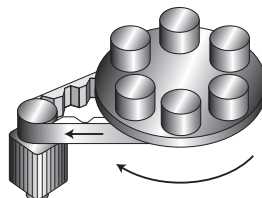

Feeding
(Labeling Machine)

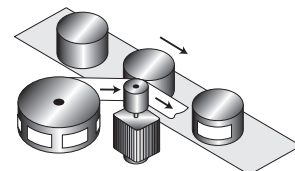

Simple

- Interactive methods for everything from adjustment to programming are available with the setup support tool SigmaWin+ for Windows (Ver.5.72 or later).
- Simple connection to the host controller can be established with the I/O module.

Smart

- Special languages are not required, because required operation patterns are easily made by simply setting the data for position and speed in program tables.
- Optimum operation method supports your application.
For positioning, up to 256 steps can be programmed.
<Operation> Program tables, Position and speed tables (station positioning), Registration (positioning by external signals), Serial communication
- Various functions, including external positioning, JOG table operation, homing, and programmable signal outputs are provided.

Speedy

- Reliable high-speed, high-precision positioning when combined with high-performance Σ -7S SERVOPACKs.
- Motion control is accomplished without using motion controllers.

Note: The INDEXER module can be used in combination with the Fully-Closed Module.



Specifications

Function	Specifications
Stations for Program Table Operation	256
JOG Speed Setting	16
ZONE Signal Output	32
Serial Communication	HR: ASCII; max. axes: 16 MEMOBUS: Binary
Homing Methods	3
Equally-dividing and Indexing Positioning (Station Positioning Command)	Rotary machine and tool setting

DeviceNet Module-Mounted Type

- Compliant with the communication specifications of the DeviceNet open field network.
- Maintainability improved by the host controller using DeviceNet to monitor the operating conditions of servo drives, alarm status, and other information.
- Full range of positioning functions featured including simple positioning, homing, continuous speed operation, positioning after continuous speed operation, and programmed operation.
- Round micro-connectors used for the connectors.
- Modules can be driven by two different power-supply methods: servo control power or external power.

Note: The DeviceNet module can be used in combination with the Fully-Closed Module.



Option Modules

Fully-Closed Module

- High-precision and high-response positioning by using feedback from detector (such as an external encoder) installed on the machine.
- High resolution with external encoders (linear scales).

Note: The Fully-Closed Module can be used in combination with the INDEXER module or DeviceNet module.



Safety Module

The Safety Module complies with EN ISO13849-1 (the standards harmonized with EU Machinery Directive 2006/42/EC) and has safety functions equivalent to those stipulated in IEC61800-5-2. By using Σ -7S SERVOPACKs with the safety module, optimum safety designs can be created for mechanical systems to better meet the needs of the industry.

- The first product for AC servo drives in Japan that has safety functions equivalent to the following ones stipulated in the international standard IEC Safe Torque Off (STO), Safe Stop 1 (SS1), Safe Stop 2 (SS2), Safely-Limited Speed (SLS)
- Two safety functions (A and B) are provided and stopping functions can be allocated individually to these safety functions.
- With the attachable Safety Modules for SERVOPACKs, system configurations are simplified and compact.



Σ-7S SERVOPACKs with FT Specifications



Choose the Best SERVOPACK for the Application

The know-how we have acquired in every market has resulted in the creation of a lineup of SERVOPACKs with FT specifications that have added functions to optimally suit a variety of applications.

✓ : Possible – : Not Possible

FT Specifications	Applications	Additional Functions	Features	Interface		
				A/P	M-II	M-III
FT19	Tracking	Built-in Less Deviation Control	Little delay in motor operations for position references as a result of built-in less deviation control. Ideal for applications that require reference tracking performance (high position accuracy) during movement.	✓	–	✓
FT21	Machining and Cutting	Feed Shaft Supporting	Improved tracking ability and high-accuracy machining operations with the use of clearance (constant distance) control, predictive control, and quadrant projection compensation functions.	–	–	✓
FT40	Press and Injection Molding	Pressure Feedback	Highly accurate pressure control with input of pressure sensor signals directly to the SERVOPACK.	–	–	✓
FT41	Press and Injection Molding	Pressure Feedback	Highly accurate pressure control by feeding back the signals of the pressure sensors directly to the SERVOPACK through the MECHATROLINK-I/O system.	–	–	✓
FT60	Conveyance	Three-Point Latching	The host controller can detect the orientation of the workpiece or offsets in multiple workpieces based on the information on the three positions input to the SERVOPACK.	–	–	✓
FT62	Conveyance and Alignment	Triggers at Pre-set Positions and Rotational Coordinate System	Addition of pass-through signals for designated points to enable coordinated operations with the use of trigger signals. Turntables can be easily controlled with infinite-length coordinates.	–	–	✓
FT77	Conveyance	Built-in Torque/Force Assistance	Multiple SERVOPACKs can be used for applications that require more than one axis to easily build a system will increase the torque or force up to five times.	✓	–	✓
FT79	Indexing	Built-in INDEXER	Convenient positioning functions (ZONE signal outputs, job speed table, homing, other) added for high-precision and high-speed positioning without a motion controller.	✓	–	–
FT82	For Special Motors	SGM7D Motor Drive	SERVOPACKs with high torque, high precision, and a user-friendly design for SGM7D motors.	✓	✓	✓
FT83	For Special Motors	SGM7D Motor Drive	SERVOPACKs with built-in INDEXER for SGM7D motors.	✓	–	–



New Two-Axis SERVOPACKs with Built-in Controllers!

Yaskawa's newest two-axis SERVOPACKs with built-in controllers offer the ideal configuration to control small-scale equipment and mechanisms to meet the increasing needs of component downsizing, equipment modularization, and system distribution.

Simple, All-in-One System Configuration

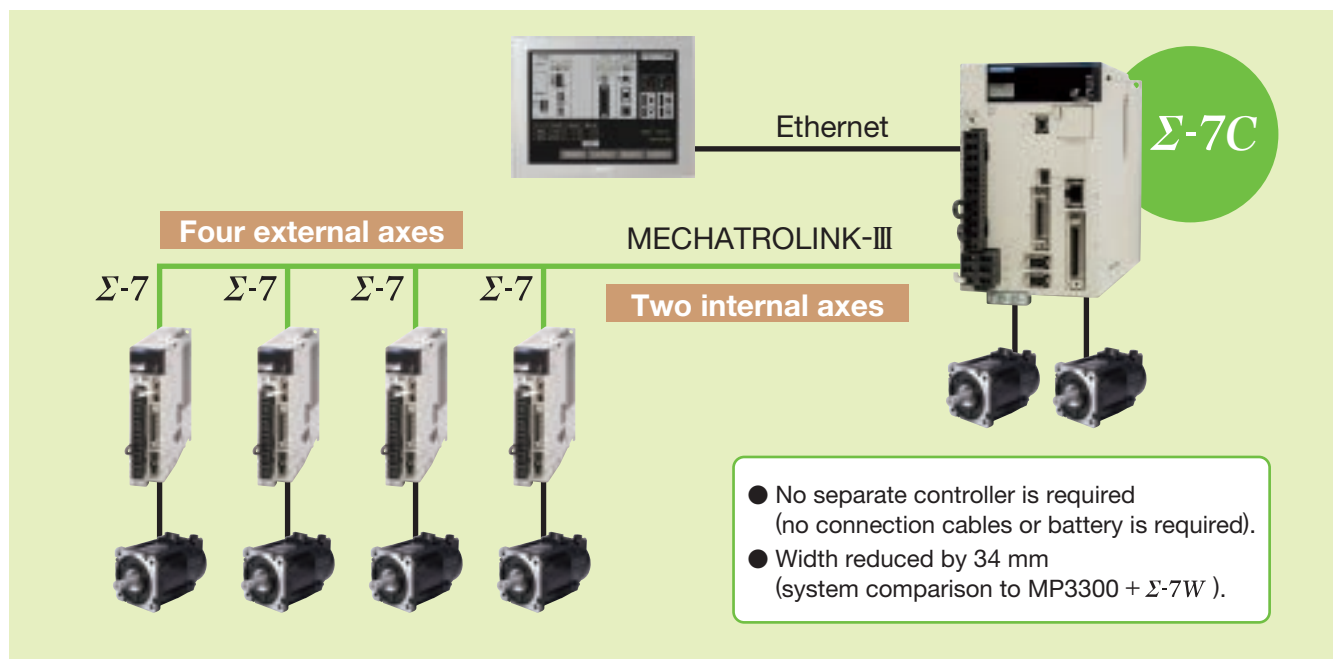

Features

Less system space required

- Configure up to six axes.
- Build small-scale equipment system without PLC using one SERVOPACK.
- Expand functionality by mounting an option unit.

Equipment modularization and distributed control system

- Reduce burden of designing software when part of the equipment changes.

High-Speed Response

- High-speed response frequency of 3.1 kHz has been achieved.
- High-speed I/O used for the Controller Function Module.
- The command/response delay is minimized with the two internal axes. These axes can be synchronized with the external axes.

Easier Maintenance

- No battery is required for the Controller Function Module, which reduces the time and cost of periodic replacement.
- Protective functions have been improved for outputs to the Controller Function Module.

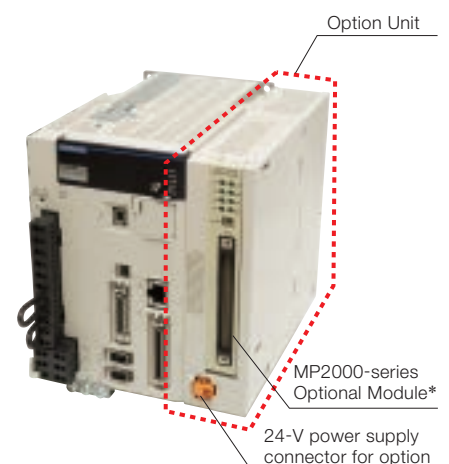





*: Excluding the following Optional Modules: SVA-01, SVB-01, SVC-01, PO-01, MPU-01, 215AIF-01, and EXIOIF.







Product Lineup

Servomotors



Rotary Servomotors

	Low inertia		Medium inertia		
					
Model	SGMMV	SGM7A	SGM7J	SGM7P	SGM7G
Rated Output	10W – 30W	50W – 7kW	50W – 750W	100W – 1.5kW	300W – 15kW

Direct Drive Servomotors

	With core, outer rotor	With core, inner rotor		Coreless, inner rotor
				
Model	SGM7D	SGM7F/SGMVCV (Small Capacity)	SGM7F/SGMCS (Medium capacity)	SGM7E/SGMCS (Small Capacity)
Rated Torque	1.30N·m – 240N·m	2.00N·m – 35.0N·m	45.0N·m – 200N·m	2.00N·m – 35.0N·m

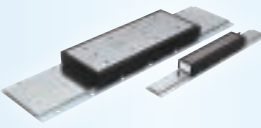
Linear Servomotors

	Coreless model	Model with iron core		
				
Model	SGLG	SGLFW2	SGLFW	SGLT
Rated Force	12.5N – 750N	45N – 1680N	25N – 1120N	130N – 900N

SERVOPACKs

● Σ -7S (Single-axis)



Analog Voltage/Pulse Train Reference
SGD7S-□□□□00A

MECHATROLINK-II Communications Reference
SGD7S-□□□□10A

MECHATROLINK-III Communications Reference
SGD7S-□□□□20A



INDEXER Module-Mounted
SGD7S□□□□E0A□□□10□

DeviceNet Module-Mounted
SGD7S□□□□E0A□□□50□
SGD7S□□□□E0A□□□60□

FT Specifications
▼ Refer to page M-26 for the line-up.

● Σ -7W (Two-axis)



MECHATROLINK-III Communications Reference
SGD7W-□□□A20A

● Σ -7C (Two-axis)



Σ -7C Two-axis SERVOPACKs with Built-in Controllers, Bus Connection Reference
SGD7C-□□□AMAA□□□

● Option Modules



Fully-Closed Module
SGDV-OFA01A

Safety Module
SGDV-OSA01A

Combination of SERVOPACKs and Option Modules

✓ : Possible – : Not Possible

SERVOPACK (Model Number)			Option Module	
			Fully-Closed Module (SGDV-OFA01A)	Safety Module (SGDV-OSA01A)
Single-axis Analog Voltage/Pulse Train Reference Type (SGD7S-□□□□00A)			✓*1	✓*1
Single-axis MECHATROLINK-II Communications Reference Type (SGD7S-□□□□10A)			✓*1	✓*1
Single-axis MECHATROLINK-III Communications Reference Type (SGD7S-□□□□20A)			✓*1	✓*1
Two-axis MECHATROLINK-III Communications Reference Type (SGD7W-□□□A20A)			–	–
SERVOPACK (Model Number of Set)	SERVOPACK (Model Number)	Command Option Module (Model Number)		
Single-axis INDEXER Module-Mounted Type (SGD7S□□□□E0A□□□10□)	Command Option Attachable Type (SGD7S-□□□□E0A)	INDEXER (SGDV-OCA03A)	✓	–
Single-axis DeviceNet Module-Mounted Type (SGD7S□□□□E0A□□□50□)*2 (SGD7S□□□□E0A□□□60□)*3		DeviceNet*2 (SGDV-OCA04A)	✓	–
		DeviceNet*3 (SGDV-OCA05A)	✓	–

*1. You cannot use a Fully-Closed Module and a Safety Module together.

*2. Driven by control power supply

*3. Driven by external power supply



System Configuration Example

Combination of Σ -7S SERVOPACK and Rotary Servomotor/Direct Drive Servomotor

- For MECHATROLINK-III Communications
Three-phase 200 VAC

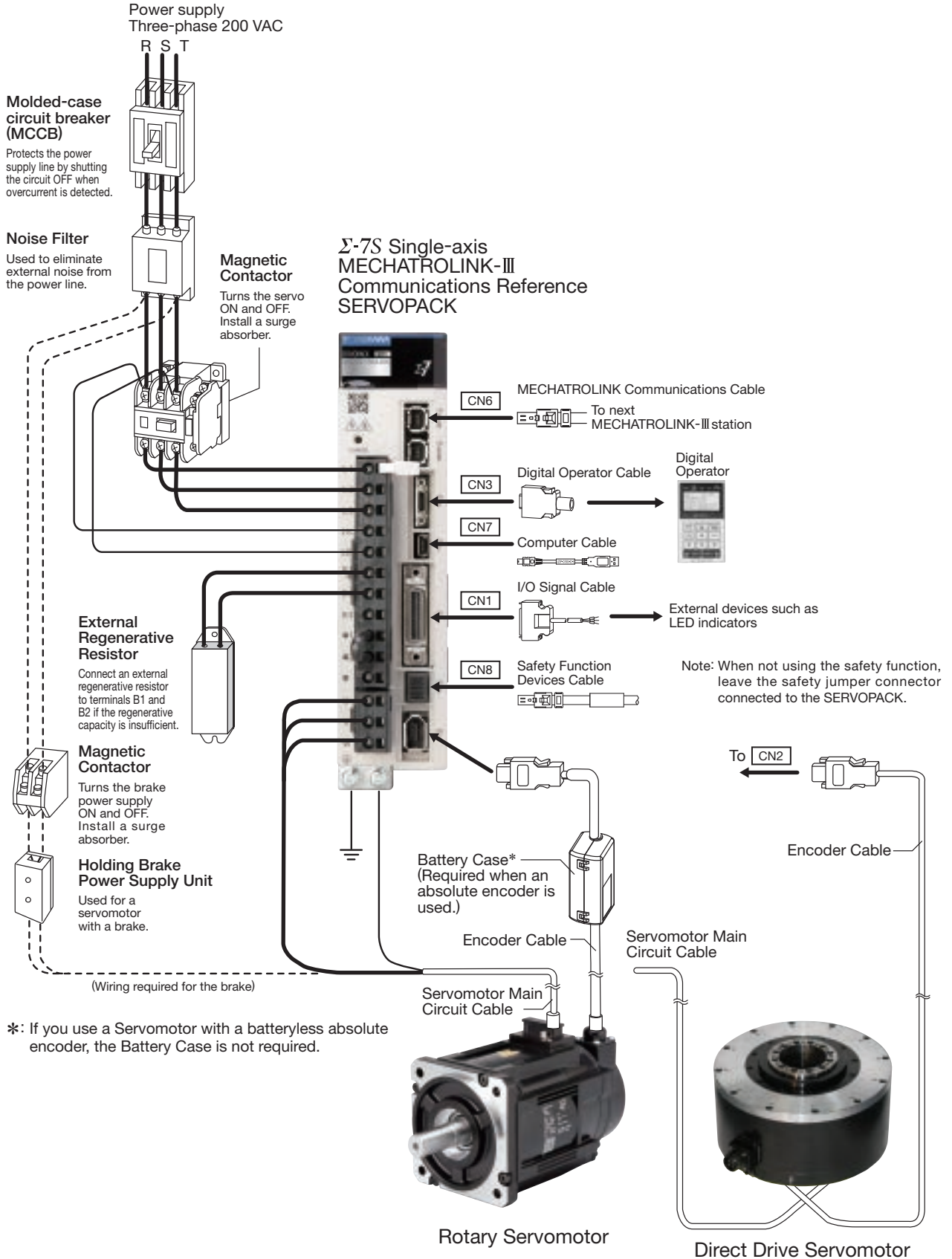

Combination of Σ -7S SERVOPACK and Linear Servomotor

● For MECHATROLINK-III Communications

Three-phase 200 VAC

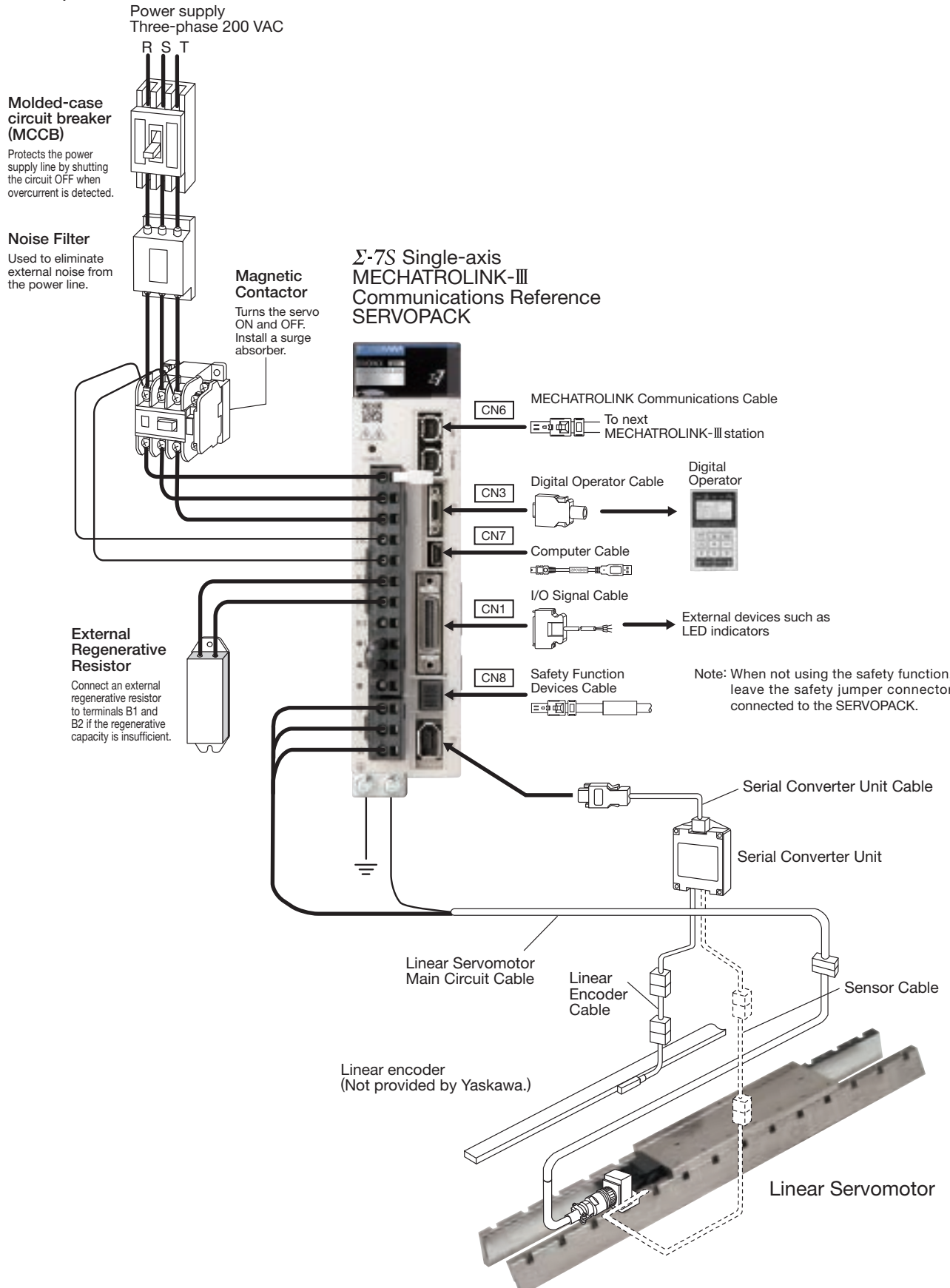



System Configuration Example

Combination of Σ -7W SERVOPACK and Rotary Servomotor/Direct Drive Servomotor

- For MECHATROLINK-III Communications
Three-phase 200 VAC

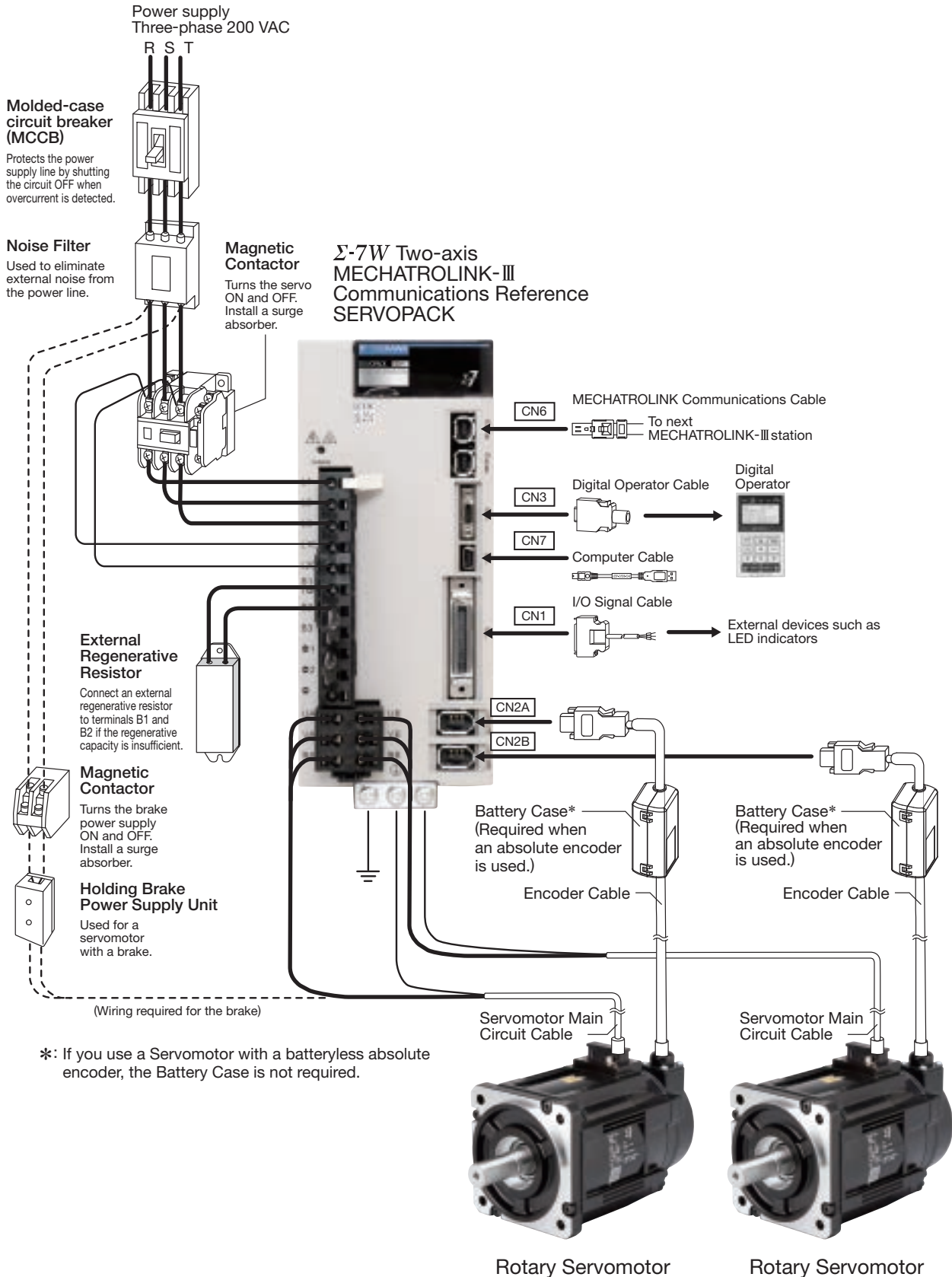



Σ-7 Series Combination

● Combination of Rotary Servomotors and SERVOPACKs

Rotary Servomotor Model		Rated Output	SERVOPACK Model	
			SGD7S-□□□□	SGD7W-□□□□ SGD7C-□□□□
SGMMV (Low inertia, ultra-small capacity) 6000min ⁻¹	SGMMV-A1A	10 W	R90A, R90F	1R6A*1, 2R8A*1
	SGMMV-A2A	20 W		
	SGMMV-A3A	30 W	1R6A, 2R1F	1R6A, 2R8A*1
SGM7J (Medium inertia, high speed) 3000 min ⁻¹	SGM7J-A5A	50 W	R70A, R70F	1R6A*1, 2R8A*1
	SGM7J-01A	100 W	R90A, R90F	
	SGM7J-C2A	150 W	1R6A, 2R1F	1R6A, 2R8A*1
	SGM7J-02A	200 W		
	SGM7J-04A	400 W	2R8A, 2R8F	2R8A, 5R5A*1, 7R6A*1
	SGM7J-06A	600 W	5R5A	5R5A, 7R6A
	SGM7J-08A	750 W		
SGM7A (Low inertia, high speed) 3000 min ⁻¹	SGM7A-A5A	50 W	R70A, R70F	1R6A*1, 2R8A*1
	SGM7A-01A	100 W	R90A, R90F	
	SGM7A-C2A	150 W	1R6A, 2R1F	1R6A, 2R8A*1
	SGM7A-02A	200 W		
	SGM7A-04A	400 W	2R8A, 2R8F	2R8A, 5R5A*1, 7R6A*1
	SGM7A-06A	600 W	5R5A	5R5A, 7R6A
	SGM7A-08A	750 W		
	SGM7A-10A	1.0 kW	120A	-
	SGM7A-15A	1.5 kW		
	SGM7A-20A	2.0 kW		
	SGM7A-25A	2.5 kW		
	SGM7A-30A	3.0 kW	200A	-
	SGM7A-40A	4.0 kW	330A	
	SGM7A-50A	5.0 kW		
SGM7A-70A	7.0 kW	550A		
SGM7P (Medium inertia, flat type) 3000 min ⁻¹	SGM7P-01A	100 W	R90A, R90F	1R6A*1, 2R8A*1
	SGM7P-02A	200 W	2R8A, 2R1F	2R8A, 5R5A*1, 7R6A*1
	SGM7P-04A	400 W	2R8A, 2R8F	
	SGM7P-08A	750 W	5R5A	5R5A, 7R6A
	SGM7P-15A	1.5 kW	120A	-
	SGM7G (Medium inertia, large torque) 1500 min ⁻¹	SGM7G-03A	300 W	3R8A
SGM7G-05A		450 W		
SGM7G-09A		850 W	7R6A	
SGM7G-13A		1.3 kW	120A	-
SGM7G-20A		1.8 kW	180A	
SGM7G-30A		2.9 kW*2	330A	
SGM7G-44A		4.4 kW		
SGM7G-55A		5.5 kW	470A	-
SGM7G-75A		7.5 kW	550A	
SGM7G-1AA		11 kW	590A	
SGM7G-1EA	15 kW	780A		

*1. If you use this combination, performance may not be as good, e.g., the control gain may not increase, in comparison with using a Σ-7S SERVOPACK.

*2. The rated output is 2.4 kW if you combine the SGM7G-30A with the SGD7S-200A.



Σ-7 Series Combination

●Combination of Direct Drive Servomotors and SERVOPACKs

Direct Drive Servomotor Model		Rated Torque N·m	Instantaneous Max. Torque N·m	SERVOPACK Model		
				SGD7S-□□□□	SGD7W-□□□□ SGD7C-□□□□	
SGM7D (With core, outer rotor)	SGM7D-30F	30.0	50.0	120A*1	-	
	SGM7D-58F	58.0	100			
	SGM7D-90F	90.0	150			
	SGM7D-1AF	110	200			
	SGM7D-01G	1.30	4.00	2R8A*1, 2R8F*1		
	SGM7D-05G	5.00	6.00			
	SGM7D-08G	8.00	15.0			
	SGM7D-18G	18.0	30.0	120A*1		
	SGM7D-24G	24.0	45.0			
	SGM7D-34G	34.0	60.0			
	SGM7D-45G	45.0	75.0			
	SGM7D-03H	3.00	4.00	2R8A*1, 2R8F*1		
	SGM7D-28I	28.0	50.0			
	SGM7D-70I	70.0	100	120A*1		
	SGM7D-1ZI	100	150			
	SGM7D-1CI	130	200			
	SGM7D-2BI	220	300			
	SGM7D-2DI	240	400			
	SGM7D-06J	6.00	8.00			
	SGM7D-09J	9.00	15.0			
	SGM7D-18J	18.0	30.0			
	SGM7D-20J	20.0	45.0			
	SGM7D-38J	38.0	60.0			
	SGM7D-02K	2.06	5.00	2R8A*1, 2R8F*1		
SGM7D-06K	6.00	10.0				
SGM7D-08K	8.00	15.0				
SGM7D-06L	6.00	10.0				
SGM7D-12L	12.0	20.0	120A*1			
SGM7D-30L	30.0	40.0				
SGM7E (Coreless, inner rotor)	SGM7E-02B	2.00	6.00	2R8A, 2R1F	2R8A	
	SGM7E-05B	5.00	15.0			
	SGM7E-07B	7.00	21.0			
	SGM7E-04C	4.00	12.0	2R8A, 2R8F		
	SGM7E-10C	10.0	30.0			
	SGM7E-14C	14.0	42.0			
	SGM7E-08D	8.00	24.0			
	SGM7E-17D	17.0	51.0	5R5A		
	SGM7E-25D	25.0	75.0			
	SGM7E-16E	16.0	48.0			
SGM7E-35E	35.0	105				
SGM7F (With core, inner rotor)	SGM7F-02A	2.00	6.00	2R8A, 2R1F	2R8A	
	SGM7F-05A	5.00	15.0			
	SGM7F-07A	7.00	21.0			
	SGM7F-04B	4.00	12.0	2R8A, 2R8F		
	SGM7F-10B	10.0	30.0			
	SGM7F-14B	14.0	42.0	5R5A		
	SGM7F-08C	8.00	24.0	2R8A, 2R8F		2R8A
	SGM7F-17C	17.0	51.0	5R5A		
	SGM7F-25C	25.0	75.0	7R6A		
	SGM7F-16D	16.0	48.0	5R5A		
	SGM7F-35D	35.0	105	7R6A*2, 120A	7R6A*2	
	SGM7F-45M	45.0	135	7R6A		
	SGM7F-80M	80.0	240	120A	-	
	SGM7F-1AM	110	330	180A		
	SGM7F-80N	80.0	240	120A		
	SGM7F-1EN	150	450	200A		
	SGM7F-2ZN	200	600			

● Combination of Direct Drive Servomotors and SERVOPACKs

Direct Drive Servomotor Model		Rated Torque N·m	Instantaneous Max. Torque N·m	SERVOPACK Model	
				SGD7S-□□□□	SGD7W-□□□□ SGD7C-□□□□
SGMCV (Small capacity, with core, inner rotor)	SGMCV-04B	4.00	12.0	2R8A, 2R8F	2R8A
	SGMCV-10B	10.0	30.0		
	SGMCV-14B	14.0	42.0	5R5A	
	SGMCV-08C	8.00	24.0	2R8A, 2R8F	2R8A
	SGMCV-17C	17.0	51.0	5R5A	
	SGMCV-25C	25.0	75.0	7R6A	
	SGMCV-16D	16.0	48.0	5R5A	
	SGMCV-35D	35.0	105	7R6A*2, 120A	7R6A*2
SGMCS (Small capacity, coreless, inner rotor)	SGMCS-02B	2.00	6.00	2R8A, 2R1F	2R8A
	SGMCS-05B	5.00	15.0		
	SGMCS-07B	7.00	21.0		
	SGMCS-04C	4.00	12.0	2R8A, 2R8F	
	SGMCS-10C	10.0	30.0		
	SGMCS-14C	14.0	42.0		
	SGMCS-08D	8.00	24.0		
	SGMCS-17D	17.0	51.0		
	SGMCS-25D	25.0	75.0		
	SGMCS-16E	16.0	48.0		
SGMCS-35E	35.0	105	5R5A		
SGMCS (Medium capacity, with core, inner rotor)	SGMCS-45M	45.0	135	7R6A	
	SGMCS-80M	80.0	240	120A	-
	SGMCS-1AM	110	330	180A	
	SGMCS-80N	80.0	240	120A	
	SGMCS-1EN	150	450	200A	
	SGMCS-2ZN	200	600		

*1 An SGM7D Servomotor is used together with an FT-specification SERVOPACK. The following SERVOPACK models can be used.

- SGD7S-□□□□□□ A□□□ F82 □
- SGD7S-□□□□ 00A□□□ F83 □

*2 Use the derated values given in the table on the right for the rated output and rated motor speed of this combination.

SERVOPACK Model		SGD7S-□□□□	SGD7W-□□□□ SGD7C-□□□□
Rated Output	W	1000	
Rated Motor Speed	min ⁻¹	270	



Σ-7 Series Combination

●Combination of Linear Servomotors and SERVOPACKs

Linear Servomotor Model		Rated Force N	Max. Force N	SERVOPACK Model		
				SGD7S-□□□□	SGD7W-□□□□ SGD7C-□□□□	
SGLG (Coreless model, with standard magnetic way)	SGLGW-30A050C	12.5	40	R70A, R70F	1R6A	
	SGLGW-30A080C	25	80	R90A, R90F		
	SGLGW-40A140C	47	140			
	SGLGW-40A253C	93	280	1R6A, 2R1F	2R8A	
	SGLGW-40A365C	140	420	2R8A, 2R8F		
	SGLGW-60A140C	70	220	1R6A, 2R1F	1R6A	
	SGLGW-60A253C	140	440	2R8A, 2R8F	2R8A	
	SGLGW-60A365C	210	660	5R5A		
	SGLGW-90A200C	325	1300	120A	-	
	SGLGW-90A370C	550	2200	180A		
SGLGW-90A535C	750	3000	200A			
SGLG (Coreless model, with high-force magnetic way)	SGLGW-40A140C	57	230	1R6A, 2R1F	1R6A	
	SGLGW-40A253C	114	460	2R8A, 2R8F	2R8A	
	SGLGW-40A365C	171	690	3R8A	5R5A	
	SGLGW-60A140C	85	360	1R6A, 2R1F	1R6A	
	SGLGW-60A253C	170	720	3R8A	5R5A	
	SGLGW-60A365C	255	1080	7R6A		
SGLF (Model with F-type iron core)	SGLFW-20A090A	25	86	1R6A, 2R1F	1R6A	
	SGLFW-20A120A	40	125			
	SGLFW-35A120A	80	220			
	SGLFW-35A230A	160	440	3R8A	5R5A	
	SGLFW-50A200B	280	600	5R5A		
	SGLFW-50A380B	560	1200	120A	-	
	SGLFW-1ZA200B					
	SGLFW-1ZA380B	1120	2400	200A	1R6A	
	SGLFW2-30A070A	45	135	1R6A, 2R1F		
	SGLFW2-30A120A	90	270			
	SGLFW2-30A230A	180	540	3R8A		-
		170	500	2R8A, 2R8F		2R8A
	SGLFW2-45A200A	280	840	5R5A		
	SGLFW2-45A380A	560	1680	180A	-	
			1500			
	SGLFW2-90A200A	560	1680	120A		
SGLFW2-90A380A	1120	3360	200A			
SGLFW2-90A560A	1680	5040	330A			
SGLFW2-1DA380A	1680	5040	200A			
SGLFW2-1DA560A	2520	7560	330A	5R5A		
SGLTW-20A170A	130	380	3R8A			
SGLTW-20A320A	250	760	7R6A			
SGLTW-20A460A	380	1140	120A	-		
SGLTW-35A170A	220	660	5R5A			
SGLTW-35A170H	300	600				
SGLTW-35A320A	440	1320	120A	-		
SGLTW-35A320H	600	1200				
SGLTW-35A460A	670	2000	180A			
SGLTW-40A400B	670	2600				
SGLTW-40A600B	1000	4000	330A			
SGLTW-50A170H	450	900	5R5A			
SGLTW-50A320H	900	1800	120A	-		
SGLTW-80A400B	1300	5000	330A			
SGLTW-80A600B	2000	7500	550A			



Recommended Encoders

◆ Incremental Linear Encoders

✓ : Possible

Output Signal	Manufacturer	Linear Encoder Type	Model			Linear Encoder Pitch μm	Resolution nm	Maximum Speed*4 m/s	Support for Polarity Sensor Input	Application to Linear Motors	Application to Fully-Closed Loop Control	
			Scale	Sensor Head	Interpolator (Serial Converter Unit)							
1 Vp-p Analog Voltage*1	Heidenhain Corporation	Exposed	LIDA48□		JZDP-H003/-H006*6	20	78.1	5	✓	✓	✓	
			LIF48□		JZDP-J003/-J006*6		4.9	2	✓	✓	*9	
	LIF48□		JZDP-H003/-H006*6	4	15.6	1	✓	✓	✓			
	LIF48□		JZDP-J003/-J006*6		1.0	0.4	✓	*9	*9			
Encoder for Yaskawa's Serial Interface*2	Renishaw plc*5	Exposed	RGS20	RGH22B	JZDP-H005/-H008*6	20	78.1	5	✓	✓	✓	
			RGS20		JZDP-J005/-J008*6		4.9	2	✓	✓	*9	
Encoder for Yaskawa's Serial Interface*2	Magnescale Co., Ltd.	Exposed	SL7□0		PL101-RY*7	800	97.7	10	–	✓	✓	
			PL101		MJ620-T13*8				–	✓	*9	
			SQ10		PQ10	MQ10-FLA	400	48.83	3	–	✓	✓
			SQ10		PQ10	MQ10-GLA				–	✓	–
		Sealed	SR75-□□□□□LF		–		80	9.8	3.33	–	✓	✓
			SR75-□□□□□MF		–		80	78.1	3.33	–	✓	✓
			SR85-□□□□□LF		–		80	9.8	3.33	–	✓	✓
			SR85-□□□□□MF		–		80	78.1	3.33	–	✓	✓

◆ Absolute Linear Encoder

✓ : Possible

Output Signal	Manufacturer	Linear Encoder Type	Model			Linear Encoder Pitch*3 μm	Resolution nm	Maximum Speed*4 m/s	Support for Polarity Sensor Input	Application to Linear Motors	Application to Fully-Closed Loop Control
			Scale	Sensor Head	Interpolator (Serial Converter Unit)						
Encoder for Yaskawa's Serial Interface*2	Magnescale Co., Ltd.	Sealed	SR77-□□□□□LF		–	80	9.8	3.33	–	✓	✓
			SR77-□□□□□MF		–	80	78.1	3.33	–	✓	✓
			SR87-□□□□□LF		–	80	9.8	3.33	–	✓	✓
			SR87-□□□□□MF		–	80	78.1	3.33	–	✓	✓
	Mitutoyo Corporation	Exposed	ST781A		–	256	500	5	–	✓	✓
			ST782A		–	256	500	5	–	✓	✓
			ST783A		–	51.2	100	5	–	✓	✓
			ST784A		–	51.2	100	5	–	✓	✓
			ST788A		–	51.2	100	5	–	✓	✓
			ST789A*10		–	25.6	50	5	–	✓	✓
			ST1381		–	5.12	10	8	–	✓	✓
	ST1382		–	0.512	1	3.6*11	–	✓	✓		
	Heidenhain Corporation	Exposed	LIC4100 series		EIB3391Y*8	20.48	5	10	–	✓	✓
		Sealed	LC115			40.96	10	3	–	✓	✓
	Renishaw plc	Exposed	EL36Y-□□050F□□□		–	12.8	50	100	–	✓	✓
			EL36Y-□□100F□□□		–	25.6	100	100	–	✓	✓
			EL36Y-□□500F□□□		–	128	500	100	–	✓	✓

- * 1. You must also use a Yaskawa Serial Converter Unit. The output signal will be multiplied by 8 bits (256 divisions) or 12 bits (4,096 divisions) in the Serial Converter Unit.
- * 2. The multiplier (number of divisions) depends on the Linear Encoder. Also, you must write the motor constant file to the Linear Encoder in advance.
- * 3. These are reference values for setting SERVOPACK parameters. Contact the manufacturer for actual linear encoder scale pitches.
- * 4. The maximum speeds given in the above table are the maximum applicable speeds of the encoders when combined with a Yaskawa SERVOPACK. The actual speed will be restricted by either the maximum speed of the Linear Servomotor or the maximum speed of the Linear Encoder (given above).

- * 5. If you use the origin signals with a Linear Encoder from Renishaw plc, the origin may sometimes be falsely detected. If that occurs, use the BID/DIR signal to output the origin signal only in one direction.
 - * 6. Use this model number to purchase the Serial Converter Unit.
 - * 7. Use this model number to purchase the Sensor Head with Interpolator.
 - * 8. Use this model number to purchase the Interpolator.
 - * 9. Contact your Yaskawa representative.
 - * 10. Contact Mitutoyo Corporation for details on the Linear Encoders.
 - * 11. The speed is restricted for some SERVOPACKs.
- Note: Confirm detailed specifications, such as the tolerances, dimensions, and operating environment, with the manufacturer of the Encoder before you use it.

◆ Absolute Rotary Encoder

The following Absolute Rotary Encoders are for fully-closed control. Can not use it to control the motor.

Output Signal	Manufacturer	Linear Encoder Type	Model		Relay Device between Fully-Closed Module and Rotary Encoder	Resolution Bits	Maximum Speed*1 min ⁻¹
			Scale	Sensor Head			
Encoder for Yaskawa's Serial Interface	Magnescale Co., Ltd.	Sealed	RU77-4096ADF		–	20	2000
			RU77-4096AFFT01		–	22	2000
	Heidenhain Corporation	Sealed	RCN2310*2		EIB3391Y	26	3000
			RCN5510*2			28	800
			RCN8310*2			29	400

- * 1. The maximum speeds given in the above table are the maximum applicable speeds of the encoders when combined with a Yaskawa SERVOPACK. The actual speed will be restricted by either the maximum speed of the Linear Servomotor or the maximum speed of the Linear Encoder (given above).

- * 2. This is a single-turn absolute encoder.
- Note: Confirm detailed specifications, such as the tolerances, dimensions, and operating environment, with the manufacturer of the Encoder before you use it.



Model Designations

● Rotary Servomotors

SGMMV

SGMMV - A1 A 2 A 2 1

Σ-Vmini Series 1st+2nd 3rd 4th 5th 6th 7th digit

Servomotors:
SGMMV

1st+2nd digits Rated Output	
Code	Specification
A1	10 W
A2	20 W
A3	30 W

3rd digit Power Supply Voltage	
Code	Specification
A	200 VAC

4th digit Serial Encoder	
Code	Specification
2	17-bit absolute

5th digit Design Revision Order	
Code	Specification
A	

6th digit Shaft End	
Code	Specification
2	Straight (standard)
A	Straight with flat seats (optional)

7th digit Options	
Code	Specification
1	Without options
C	With holding brake (24 VDC)

SGM7J

● Without Gears

SGM7J - 01 A 7 A 2 1

Σ-7 Series 1st+2nd 3rd 4th 5th 6th 7th digit

Servomotors:
SGM7J

1st+2nd digits Rated Output	
Code	Specification
A5	50 W
01	100 W
C2	150 W
02	200 W
04	400 W
06	600 W
08	750 W

3rd digit Power Supply Voltage	
Code	Specification
A	200 VAC

4th digit Serial Encoder	
Code	Specification
6	24-bit batteryless absolute
7	24-bit absolute
F	24-bit incremental

5th digit Design Revision Order	
Code	Specification
A	

6th digit Shaft End	
Code	Specification
2	Straight without key
6	Straight with key and tap
B	With two flat seats

7th digit Options	
Code	Specification
1	Without options
C	With holding brake (24 VDC)
E	With oil seal and holding brake (24 VDC)
S	With oil seal

● With Gears

SGM7J - 01 A 7 A H 1 2 1

Σ-7 Series 1st+2nd 3rd 4th 5th 6th 7th 8th 9th digit

Servomotors:
SGM7J

1st+2nd digits Rated Output	
Code	Specification
A5	50 W
01	100 W
C2	150 W
02	200 W
04	400 W
06	600 W
08	750 W

3rd digit Power Supply Voltage	
Code	Specification
A	200 VAC

4th digit Serial Encoder	
Code	Specification
6	24-bit batteryless absolute
7	24-bit absolute
F	24-bit incremental

5th digit Design Revision Order	
Code	Specification
A	

6th digit Gear Type	
Code	Specification
H	HDS planetary low-backlash gear

7th digit Gear Ratio	
Code	Specification
B	1/11*1
C	1/21
1	1/5
2	1/9*2
7	1/33

*1. This specification is not supported for models with a rated output of 50 W.
*2. This specification is supported only for models with a rated output of 50 W.

8th digit Shaft End	
Code	Specification
0	Flange output
2	Straight without key
6	Straight with key and tap

9th digit Options	
Code	Specification
1	Without options
C	With holding brake (24 VDC)

SGM7A

● Without Gears

SGM7A - 01 A 7 A 2 1

Σ-7 Series 1st+2nd 3rd 4th 5th 6th 7th digit

Servomotors:
SGM7A

1st+2nd digits Rated Output	
Code	Specification
A5	50 W
01	100 W
C2	150 W
02	200 W
04	400 W
06	600 W
08	750 W
10	1.0 kW
15	1.5 kW
20	2.0 kW
25	2.5 kW
30	3.0 kW
40	4.0 kW
50	5.0 kW
70	7.0 kW

3rd digit Power Supply Voltage	
Code	Specification
A	200 VAC

4th digit Serial Encoder	
Code	Specification
6	24-bit batteryless absolute
7	24-bit absolute
F	24-bit incremental

5th digit Design Revision Order	
Code	Specification
A	

6th digit Shaft End	
Code	Specification
2	Straight without key
6	Straight with key and tap
B*	With two flat seats

* Code B is not supported for models with a rated output of 1.5 kW or higher.

7th digit Options	
Code	Specification
1	Without options
C	With holding brake (24 VDC)
E	With oil seal and holding brake (24 VDC)
S	With oil seal

Note: SGM7A-70A Servomotors with holding brakes are not available.

● With Gears

SGM7A - 01 A 7 A H 1 2 1

Σ-7 Series 1st+2nd 3rd 4th 5th 6th 7th 8th 9th digit

Servomotors:
SGM7A

1st+2nd digits Rated Output	
Code	Specification
A5	50 W
01	100 W
C2	150 W
02	200 W
04	400 W
06	600 W
08	750 W
10	1.0 kW

3rd digit Power Supply Voltage	
Code	Specification
A	200 VAC

4th digit Serial Encoder	
Code	Specification
6	24-bit batteryless absolute
7	24-bit absolute
F	24-bit incremental

Note: Contact your Yaskawa representative for models of 1.5 kW or higher.

5th digit Design Revision Order	
Code	Specification
A	

6th digit Gear Type	
Code	Specification
H	HDS planetary low-backlash gear

7th digit Gear Ratio	
Code	Specification
B	1/11*1
C	1/21
1	1/5
2	1/9*2
7	1/33

*1. This specification is not supported for models with a rated output of 50 W.
*2. This specification is supported only for models with a rated output of 50 W.

8th digit Shaft End	
Code	Specification
0	Flange output
2	Straight without key
6	Straight with key and tap

9th digit Options	
Code	Specification
1	Without options
C	With holding brake (24 VDC)

● Rotary Servomotors

SGM7P

● Without Gears

SGM7P - 01 A 7 A 2 1

Σ-7 Series 1st+2nd digit 3rd 4th 5th 6th 7th digit

Servomotors:
SGM7P

1st+2nd digits		Rated Output
Code	Specification	
01	100 W	
02	200 W	
04	400 W	
08	750 W	
15	1.5 kW	

3rd digit		Power Supply Voltage
Code	Specification	
A	200 VAC	

4th digit		Serial Encoder
Code	Specification	
6	24-bit batteryless absolute	
7	24-bit absolute	
F	24-bit incremental	

5th digit		Design Revision Order
Code	Specification	
A	IP65	
E	IP67	

6th digit		Shaft End
Code	Specification	
2	Straight without key	
6	Straight with key and tap	

7th digit		Options
Code	Specification	
1	Without options	
C	With holding brake (24 VDC)	
E	With oil seal and holding brake (24 VDC)	
S	With oil seal	

● With Gears

SGM7P - 01 A 7 A H B 0 1

Σ-7 Series 1st+2nd digit 3rd 4th 5th 6th 7th 8th 9th digit

Servomotors:
SGM7P

1st+2nd digits		Rated Output
Code	Specification	
01	100 W	
02	200 W	
04	400 W	
08	750 W	
15	1.5 kW	

3rd digit		Power Supply Voltage
Code	Specification	
A	200 VAC	

4th digit		Serial Encoder
Code	Specification	
6	24-bit batteryless absolute	
7	24-bit absolute	
F	24-bit incremental	

5th digit		Design Revision Order
Code	Specification	
A	IP55	

6th digit		Gear Type
Code	Specification	
H	HDS planetary low-backlash gear	

7th digit		Gear Ratio
Code	Specification	
B	1/11	
C	1/21	
1	1/5	
7	1/33	

8th digit		Shaft End
Code	Specification	
0	Flange output	
2	Straight without key	
6	Straight with key and tap	

9th digit		Options
Code	Specification	
1	Without options	
C	With holding brake (24 VDC)	

SGM7G

SGM7G - 03 A 7 A 2 1

Σ-7 Series 1st+2nd digit 3rd 4th 5th 6th 7th digit

Servomotors:
SGM7G

1st+2nd digits		Rated Output
Code	Specification	
03	300 W	
05	450 W	
09	850 W	
13	1.3 kW	
20	1.8 kW	
30	2.9 kW*	
44	4.4 kW	
55	5.5 kW	
75	7.5 kW	
1A	11 kW	
1E	15 kW	

* : The rated output is 2.4 kW if you combine the SGM7G-30A with the SGD7S-200A.

3rd digit		Power Supply Voltage
Code	Specification	
A	200 VAC	

4th digit		Serial Encoder
Code	Specification	
6	24-bit batteryless absolute	
7	24-bit absolute	
F	24-bit incremental	

5th digit		Design Revision Order
Code	Specification	
A		

6th digit		Shaft End
Code	Specification	
2	Straight without key	
6	Straight with key and tap	

7th digit		Options
Code	Specification	
1	Without options	
C	With holding brake (24 VDC)	
E	With oil seal and holding brake (24 VDC)	
S	With oil seal	

● Direct Drive Servomotors

Note: Direct Drive Servomotors are not available with holding brakes.

SGM7D

SGM7D - 30 F 7 C 4 1

Direct Drive 1st+2nd digit 3rd 4th 5th 6th 7th digit

Servomotors:
SGM7D

1st+2nd digits		Rated Output	
Code	Specification		
01	1.36 N·m	30	30.0 N·m
02	2.06 N·m	34	34.0 N·m
03	3.00 N·m	38	38.0 N·m
05	5.00 N·m	45	45.0 N·m
06	6.00 N·m	58	58.0 N·m
08	8.00 N·m	70	70.0 N·m
09	9.00 N·m	90	90.0 N·m
12	12.0 N·m	1Z	100 N·m
18	18.0 N·m	1A	110 N·m
20	20.0 N·m	1C	130 N·m
24	24.0 N·m	2B	220 N·m
28	28.0 N·m	2D	240 N·m

3rd digit		Servomotor Outer Diameter	
Code	Specification	Code	Specification
F	264-mm dia.	J	150-mm dia.
G	160-mm dia.	K	107-mm dia.
H	116-mm dia.	L	224 mm x 224 mm
I	264-mm dia.		

4th digit		Serial Encoder
Code	Specification	
7	24-bit multi-turn absolute encoder*	
F	24-bit incremental encoder*	

*: Both multiturn absolute encoder and incremental encoder can be used as a single-turn absolute encoder by setting parameters.

5th digit		Design Revision Order
Code	Specification	
C		

6th digit		Flange		✓ : Applicable models.						
Code	Mounting	Servomotor Outer Diameter Code (3rd Digit)								
		F	G	H	I	J	K	L		
4	Non-load	✓	✓	✓	—	—	—	✓		
	side	✓	✓*	—	✓	✓	✓	—		
5	with cable on side	✓	✓	✓	—	—	—	✓		
	with cable on bottom	✓	✓*	—	✓	✓	✓	—		

*: SGM7D-01G and -05G are not available with a cable extending from the bottom.

7th digit		Options
Code	Specification	
1	Standard machine precision	
2	High machine precision*	

*: The SGM7D-01G, -05G, and -03H are available only with high mechanical precision.



Model Designations

● Direct Drive Servomotors

Note: Direct Drive Servomotors are not available with holding brakes.

SGM7E

SGM7E - 02 B 7 A 1 1

Direct Drive 1st+2nd 3rd 4th 5th 6th 7th digit

Servomotors:
SGM7E

1st+2nd digits Rated Output	
Code	Specification
02	2.00 N·m
04	4.00 N·m
05	5.00 N·m
07	7.00 N·m
08	8.00 N·m
10	10.0 N·m
14	14.0 N·m
16	16.0 N·m
17	17.0 N·m
25	25.0 N·m
35	35.0 N·m

3rd digit Servomotor Outer Diameter	
Code	Specification
B	135-mm dia.
C	175-mm dia.
D	230-mm dia.
E	290-mm dia.

4th digit Serial Encoder	
Code	Specification
7	24-bit multiturn absolute encoder*
F	24-bit incremental encoder*

* Both multiturn absolute encoder and incremental encoder can be used as a single-turn absolute encoder by setting parameters.

5th digit Design Revision Order	
Code	Specification
A	

6th digit Flange	
Code	Mounting
1	Non-load side
4	Non-load side (with cable on side)

7th digit Options	
Code	Specification
1	Without options
2	High machine precision (runout at end of shaft and runout of shaft surface: 0.01 mm)

Note: 1. Direct Drive Servomotors are not available with holding brakes.
2. This information is provided to explain model numbers. It is not meant to imply that models are available for all combinations of codes.

SGM7F

SGM7F - 02 A 7 A 1 1

Direct Drive 1st+2nd 3rd 4th 5th 6th 7th digit

Servomotors:
SGM7F

1st+2nd digits Rated Output			
• Small-capacity			
Code	Specification	Code	Specification
02	2.00 N·m	14	14.0 N·m
04	4.00 N·m	16	16.0 N·m
05	5.00 N·m	17	17.0 N·m
07	7.00 N·m	25	25.0 N·m
08	8.00 N·m	35	35.0 N·m
10	10.0 N·m		

• Medium-capacity	
Code	Specification
45	45.0 N·m
80	80.0 N·m
1A	110 N·m
1E	150 N·m
2Z	200 N·m

3rd digit Servomotor Outer Diameter	
Code	Specification
A	100-mm dia.
B	135-mm dia.
C	175-mm dia.
D	230-mm dia.
M	280-mm dia.
N	360-mm dia.

4th digit Serial Encoder	
Code	Specification
7	24-bit multiturn absolute encoder*
F	24-bit incremental encoder*

* Both multiturn absolute encoder and incremental encoder can be used as a single-turn absolute encoder by setting parameters.

5th digit Design Revision Order	
Code	Specification
A	

6th digit Flange		✓ : Applicable models.					
Code	Mounting	Servomotor Outer Diameter Code (3rd Digit)					
		A	B	C	D	M	N
1	Non-load side	✓	✓	✓	✓	—	—
	Load side	—	—	—	—	✓	✓
3	Non-load side	—	—	—	—	✓	✓
4	Non-load side (with cable on side)	✓	✓	✓	✓	—	—

7th digit Options	
Code	Specification
1	Without options
2	High machine precision (runout at end of shaft and runout of shaft surface: 0.01 mm)

Note: 1. Direct Drive Servomotors are not available with holding brakes.
2. This information is provided to explain model numbers. It is not meant to imply that models are available for all combinations of codes.

SGMCMV

SGMCMV - 04 B E A 1 1

Direct Drive 1st+2nd 3rd 4th 5th 6th 7th digit

Servomotors:
SGMCMV

1st+2nd digits Rated Output	
Code	Specification
04	4.00 N·m
08	8.00 N·m
10	10.0 N·m
14	14.0 N·m
16	16.0 N·m
17	17.0 N·m
25	25.0 N·m
35	35.0 N·m

3rd digit Servomotor Outer Diameter	
Code	Specification
B	135-mm dia.
C	175-mm dia.
D	230-mm dia.

4th digit Serial Encoder	
Code	Specification
E	22-bit single-turn absolute encoder
I	22-bit multiturn absolute encoder

5th digit Design Revision Order	
Code	Specification
A	

6th digit Flange	
Code	Specification
1	Non-load side
4	Non-load side (with cable on side)

7th digit Options	
Code	Specification
1	Without options
5	High machine precision (runout at end of shaft and runout of shaft surface: 0.01 mm)

* Both multiturn absolute encoder and incremental encoder can be used as a single-turn absolute encoder by setting parameters.

SGMCS

SGMCS - 02 B 3 C 1 1

Direct Drive 1st+2nd 3rd 4th 5th 6th 7th digit

Servomotors:
SGMCS

1st+2nd digits Rated Output			
• Small-capacity, Coreless			
Code	Specification	Code	Specification
02	2.00 N·m	14	14.0 N·m
04	4.00 N·m	16	16.0 N·m
05	5.00 N·m	17	17.0 N·m
07	7.00 N·m	25	25.0 N·m
08	8.00 N·m	35	35.0 N·m
10	10.0 N·m		

• Medium-capacity, with Core	
Code	Specification
45	45.0 N·m
80	80.0 N·m
1A	110 N·m
1E	150 N·m
2Z	200 N·m

3rd digit Servomotor Outer Diameter	
Code	Specification
B	135-mm dia.
C	175-mm dia.
D	230-mm dia.
E	290-mm dia.
M	280-mm dia.
N	360-mm dia.

4th digit Serial Encoder	
Code	Specification
3	20-bit single-turn absolute encoder
D	20-bit incremental encoder

5th digit Design Revision Order	
Code	Specification
A	Model with servomotor outer diameter code M or N
B	Model with servomotor outer diameter code E
C	Model with servomotor outer diameter code B, C, or D

6th digit Flange		✓ : Applicable models.					
Code	Mounting	Servomotor Outer Diameter Code (3rd Digit)					
		B	C	D	E	M	N
1	Non-load side	✓	✓	✓	✓	—	—
	Load side	—	—	—	—	✓	✓
3	Non-load side	—	—	—	—	✓	✓
4	Non-load side (with cable on side)	✓	✓	✓	✓	—	—

7th digit Options	
Code	Specification
1	Without options

* Both multiturn absolute encoder and incremental encoder can be used as a single-turn absolute encoder by setting parameters.

● Linear Servomotors

SGLG (Coreless Models)

● Moving Coil

S G L G W - 30 A 050 C P □

Linear Σ 1st 2nd 3rd+4th 5th 6th+7th+8th 9th 10th 11th digit

Series

Linear

Servomotors

1st digit Servomotor Type		5th digit Power Supply Voltage	
Code	Specification	Code	Specification
G	Coreless model	A	200 VAC

2nd digit Moving Coil/Magnetic Way		6th+7th+8th digits Length of Moving Coil	
Code	Specification	Code	Specification
W	Moving Coil	050	50 mm
		080	80 mm
		140	140 mm
		200	199 mm
		253	252.5 mm
		365	365 mm
		370	367 mm
		535	535 mm

3rd+4th digits Magnet Height	
Code	Specification
30	30 mm
40	40 mm
60	60 mm
90	86 mm

9th digit	Design Revision Order
A, B...	

10th digit Sensor Specification and Cooling Method			
Code			Specifications
Code	Polarity Sensor	Cooling Method	Applicable Models
None	None	Self-cooled	All models
C	None	Air-cooled	SGLGW-40A, -60A, -90A
H	Yes	Air-cooled	All models
P	Yes	Self-cooled	All models

11th digit Connector for Servomotor Main Circuit Cable		
Code		Specifications
Code	Specification	Applicable Models
None	Connector from Tyco Electronics Japan G.K.	All models
D	Connector from Interconnectron GmbH	SGLGW-30A, -40A, -60A

Note: This information is provided to explain model numbers. It is not meant to imply that models are available for all combinations of codes.

SGLFW2 (Models with F-type Iron Cores)

● Moving Coil

S G L F W2 - 30 A 070 A T □

Linear Σ 1st 2nd 3rd+4th 5th 6th+7th+8th 9th 10th 11th digit

Series

Linear

Servomotors

1st digit Servomotor Type		5th digit Power Supply Voltage	
Code	Specification	Code	Specification
F	With F-type iron core	A	200 VAC

2nd digit Moving Coil/Magnetic Way		6th+7th+8th digits Length of Moving Coil	
Code	Specification	Code	Specification
W	Moving Coil	070	70 mm
		120	125 mm
		200	205 mm
		230	230 mm
		380	384 mm
		560	563 mm

3rd+4th digits Magnet Height	
Code	Specification
30	30 mm
45	45 mm
90	90 mm
1D	135 mm

9th digit	Design Revision Order
A	

10th digit Sensor Specification	
Code	Specification
S	With polarity sensor and thermal protector
T	Without polarity sensor, with thermal protector

11th digit Cooling Method	
Code	Specification
None	Self-cooled
L	Water-cooled*

* Contact your Yaskawa representative for information on water-cooled models.

Note: This information is provided to explain model numbers. It is not meant to imply that models are available for all combinations of codes.

● Magnetic Way

S G L G M - 30 108 A □

Linear Σ 1st 2nd 3rd+4th 5th+6th+7th 8th 9th digit

Series

Linear

Servomotors

1st digit Servomotor Type		5th+6th+7th digits Length of Magnetic Way	
Code	Specification	Code	Specification
G	Coreless model	090	90 mm
		108	108 mm
		216	216 mm
		225	225 mm
		252	252 mm
		360	360 mm
		405	405 mm
		432	432 mm
		450	450 mm
		504	504 mm

2nd digit Moving Coil/Magnetic Way	
Code	Specification
M	Magnetic Way

3rd+4th digits Magnet Height	
Code	Specification
30	30 mm
40	40 mm
60	60 mm
90	86 mm

8th digit	Design Revision Order
A, B, C...	

9th digit Options		
Code	Specification	Applicable Models
None	Standard-force	All models
-M	High-force	SGLGM-40, -60

* The SGLGM-40 and SGLGM-60 also have a CT code.

· C = Without mounting holes on the bottom

· CT = With mounting holes on the bottom



Model Designations

● Linear Servomotors

SGLFW (Models with F-type Iron Cores)

● Moving Coil

S G L F W - 20 A 090 A P □

Linear Σ 1st 2nd 3rd+4th 5th 6th+7th+8th 9th 10th 11th digit

Series

Linear

Servomotors

1st digit		Servomotor Type		5th digit		Voltage	
Code	Specification	Code	Specification	Code	Specification	Code	Specification
F	With F-type iron core	A	200 VAC				
2nd digit		Moving Coil/Magnetic Way		6th+7th+8th digits		Length of Moving Coil	
Code	Specification	Code	Specification	Code	Specification	Code	Specification
W	Moving Coil	090	91 mm	120	127 mm	200	215 mm
		120	127 mm	230	235 mm	380	395 mm
3rd+4th digits		Magnet Height		9th digit			
Code	Specification	Code	Specification	Design Revision Order			
20	20 mm			A, B...			
35	36 mm						
50	47.5 mm						
1Z	95 mm						
10th digit		Sensor Specification		11th digit			
Code	Specification	Code		Specification		Applicable Models	
P	With polarity sensor	None		Connector from Tyco Electronics Japan G.K.		All models	
None	Without polarity sensor	D		Connector from Interconnectron GmbH		SGLFW-35, -50, -1Z□200B	

● Magnetic Way

S G L F M - 20 324 A □

Linear Σ 1st 2nd 3rd+4th 5th+6th+7th 8th 9th digit

Series

Linear

Servomotors

1st digit		Servomotor Type		5th+6th+7th digits		Length of Magnetic Way	
Code	Specification	Code	Specification	Code	Specification	Code	Specification
F	With F-type iron core			324	324 mm		
				405	405 mm		
				540	540 mm		
				675	675 mm		
				756	756 mm		
				945	945 mm		
2nd digit		Moving Coil/Magnetic Way		8th digit			
Code	Specification	Code		Specification		Design Revision Order	
M	Magnetic Way					A, B...	
3rd+4th digits		Magnet Height		9th digit			
Code	Specification	Code		Specification		Options	
20	20 mm	None		Without options			
35	36 mm	C		With magnet cover			
50	47.5 mm	Y		With base and magnet cover			
1Z	95 mm						

Note: This information is provided to explain model numbers. It is not meant to imply that models are available for all combinations of codes.

SGLT (Models with T-type Iron Cores)

● Moving Coil

S G L T W - 20 A 170 A P □

Linear Σ 1st 2nd 3rd+4th 5th 6th+7th+8th 9th 10th 11th digit

Series

Linear

Servomotors

1st digit		Servomotor Type		5th digit		Power Supply Voltage		
Code	Specification	Code	Specification	Code	Specification	Code	Specification	
T	With T-type iron core	A	200 VAC					
2nd digit		Moving Coil/Magnetic Way		6th+7th+8th digits		Length of Moving Coil		
Code	Specification	Code	Specification	Code	Specification	Code	Specification	
W	Moving Coil	170	170 mm	320	315 mm	400	394.2 mm	
		320	315 mm	460	460 mm	600	574.2 mm	
3rd+4th digits		Magnet Height		9th digit				
Code	Specification	Code		Specification		Design Revision Order		
20	20 mm					A, B...		
35	36 mm					H: High-efficiency model		
40	40 mm							
50	51 mm							
80	76.5 mm							
10th digit		Sensor Specification and Cooling Method		11th digit				
Code	Polarity Sensor	Cooling Method	Code		Specification		Applicable Models	
None	None	Self-cooled	None		Water-cooled		All models	
C*	None	Water-cooled	SGLT-40		-80		SGLTW-40, -80	
H*	Yes	Water-cooled						
P	Yes	Self-cooled						
11th digit		Connector for Servomotor Main Circuit Cable		11th digit				
Code	Specification	Code		Specification		Applicable Models		
None	Connector from Tyco Electronics Japan G.K.	SGLTW-20A□□□□□□□□□□		-35A□□□□□□□□□□		SGLTW-20A□□□□□□□□□□, -35A□□□□□□□□□□		
	MS connector	SGLTW-40A□□□□□□□□□□		-80A□□□□□□□□□□		SGLTW-40A□□□□□□□□□□, -80A□□□□□□□□□□		
	Loose lead wires with no connector	SGLTW-35A□□□□□□□□□□		-50A□□□□□□□□□□		SGLTW-35A□□□□□□□□□□, -50A□□□□□□□□□□		

● Magnetic Way

S G L T M - 20 324 A □

Linear Σ 1st 2nd 3rd+4th 5th+6th+7th 8th 9th digit

Series

Linear

Servomotors

1st digit		Servomotor Type		5th+6th+7th digits		Length of Magnetic Way	
Code	Specification	Code	Specification	Code	Specification	Code	Specification
T	With T-type iron core			324	324 mm		
				405	405 mm		
				540	540 mm		
				675	675 mm		
				756	756 mm		
				945	945 mm		
2nd digit		Moving Coil/Magnetic Way		8th digit			
Code	Specification	Code		Specification		Design Revision Order	
M	Magnetic Way					A, B...	
						H: High-efficiency model	
3rd+4th digits		Magnet Height		9th digit			
Code	Specification	Code		Specification		Options	
20	20 mm	None		Without options			
35	36 mm	C		With magnet cover			
40	40 mm	Y		With base and magnet cover			
50	51 mm						
80	76.5 mm						

* The SGLTM-35□□□□H (high-efficiency models) do not support this specification.

* Contact your Yaskawa representative for the characteristics, dimensions, and other details on Servomotors with these specifications.

Note: This information is provided to explain model numbers. It is not meant to imply that models are available for all combinations of codes.

● SERVOPACKS

Σ-7S Model

SGD7S - R70 A 20 A 001 000 B

Σ-7 Series 1st+2nd+3rd 4th 5th+6th 7th 8th+9th+10th 11th+12th+13th 14th digit
Σ-7S Models

1st+2nd+3rd digits		Maximum Applicable Motor Capacity	
Voltage	Code	Code	Specification
Three-phase, 200 VAC	R70*1	0.05 kW	
	R90*1	0.1 kW	
	1R6*1	0.2 kW	
	2R8*1	0.4 kW	
	3R8	0.5 kW	
	5R5*1	0.75 kW	
	7R6	1.0 kW	
	120*2	1.5 kW	
	180	2.0 kW	
	200*3	3.0 kW	
	330	5.0 kW	
	470	6.0 kW	
	550	7.5 kW	
	590	11 kW	
780	15 kW		
Single-phase, 100 VAC	R70	0.05 kW	
	R90	0.1 kW	
	2R1	0.2 kW	
	2R8*7	0.4 kW	

4th digit Voltage	
Code	Specification
A	200 VAC
F	100 VAC

5th+6th digits Interface*3	
Code	Specification
00	Analog voltage/pulse train reference
10	MECHATROLINK-II communications reference
20	MECHATROLINK-III communications reference
E0	Command Option Attachable Type*4

7th digit Design Revision Order	
Code	Specification
A	

8th+9th+10th digits Hardware Options Specification		
Code	Specification	Applicable Models
None	Without options	All models
001	Rack-mounted	SGD7S-R70A to -330A SGD7S-R70F to -2R8F
	Duct-ventilated	SGD7S-470A to -780A
002	Varnished	All models
008	Single-phase, 200-VAC power supply input	SGD7S-120A
020*6	No dynamic brake	SGD7S-R70A to -2R8A SGD7S-R70F to -2R8F
	External dynamic brake resistor	SGD7S-3R8A to -780A

11th+12th+13th digits FT/EX Specification	
Code	Specification
None	None
000	None
F82*7	Application function option for special motors, SGM7D motor drive
F83*7	Application function option for special motors, SGM7D motor drive, indexing

14th digit BTO Specification*8 (Available in Japan only)	
Code	Specification
None	None
B	BTO Specification

- *1. You can use these models with either a single-phase or three-phase power supply input.
- *2. A model with a single-phase, 200-VAC power supply input is available as a hardware option (model. SGD7S-120A□0A008).
- *3. The rated output is 2.4 kW if you combine the SGM7G-30A with the SGD7S-200A.
- *4. The same SERVOPACKS are used for both Rotary Servomotors and Linear Servomotors.
- *5. A command option module must be attached to the Command Option Attachable-type SERVOPACK for use. Refer to pages 356 to 381 for details.
- *6. Refer to the following manual for details.
□ □ Σ-7-Series AC Servo Drive Σ-7S/Σ-7W SERVOPACK with Hardware Option Specifications Dynamic Brake Product Manual (Manual No.: SIEP S800001 73)
- *7. Refer to the following manual for details.
□ □ Σ-7-Series AC Servo Drive Σ-7S SERVOPACK with FT/EX Specification for SGM7D Motor Product Manual (Manual No.: SIEP S800001 91)
- *8. The BTO specification indicates if the SERVOPACK is customized by using the MechatroCloud BTO service. This service is available in Japan only.
You need a BTO number to order SERVOPACKS with customized specifications. Refer to page M-15 for the details on the BTO service.

Σ-7W Model

SGD7W - 1R6 A 20 A 001 000 B

Σ-7 Series 1st+2nd+3rd 4th 5th+6th 7th 8th+9th+10th 11th+12th+13th 14th digit
Σ-7W Models

1st+2nd+3rd digits		Maximum Applicable Motor Capacity per Axis	
Voltage	Code	Code	Specification
Three-phase, 200 VAC	1R6*1	0.2 kW	
	2R8*1	0.4 kW	
	5R5*2	0.75 kW	
	7R6	1.0 kW	

5th+6th digits Interface*3	
Code	Specification
20	MECHATROLINK-III communications reference

7th digit Design Revision Order	
Code	Specification
A	

8th+9th+10th digits Hardware Options Specification		
Code	Specification	Applicable Models
None	Without options	All models
001	Rack-mounted	All models
002	Varnished	All models
020*4	No dynamic brake	SGD7W-1R6A to -2R8A
	External dynamic brake resistor	SGD7W-5R5A to -7R6A
700*5	HWBB option	All models

11th+12th+13th digits FT/EX Specification	
Code	Specification
None	None
000	None

14th digit BTO Specification*6 (Available in Japan only)	
Code	Specification
None	None
B	BTO Specification

- *1. You can use these models with either a single-phase or three-phase power supply input.
- *2. If you use the SGD7W-5R5A with a single-phase 200-VAC power supply input, derate the load ratio to 65%. An example is given below.
If the load ratio of the first axis is 90%, use a load ratio of 40% for the second axis so that average load ratio for both axes is 65% ((90% + 40%)/2 = 65%).
- *3. The same SERVOPACKS are used for both Rotary Servomotors and Linear Servomotors.
- *4. Refer to the following manual for details.
□ □ Σ-7 Series AC Servo Drive Σ-7S/Σ-7W SERVOPACK with Hardware Option Specifications Dynamic Brake Product Manual (Manual No.: SIEP S800001 73)
- *5. Refer to the following manual for details.
□ □ Σ-7 Series AC Servo Drive Σ-7W/Σ-7C SERVOPACK with Hardware Option Specifications HWBB Function Product Manual (Manual No.: SIEP S800001 72)
- *6. The BTO specification indicates if the SERVOPACK is customized by using the MechatroCloud BTO service. This service is available in Japan only.
You need a BTO number to order SERVOPACKS with customized specifications. Refer to page M-15 for the details on the BTO service.

Σ-7C Model

SGD7C - 1R6 A MA A 001

Σ-7 Series 1st+2nd+3rd 4th 5th+6th 7th 8th+9th+10th digit
Σ-7C Models

1st+2nd+3rd digits		Maximum Applicable Motor Capacity per Axis	
Voltage	Code	Code	Specification
Three-phase, 200 VAC	1R6*1	0.2 kW	
	2R8*1	0.4 kW	
	5R5*2	0.75 kW	
	7R6	1.0 kW	

4th digit Voltage	
Code	Specification
A	200 VAC

5th+6th digits Interface*3	
Code	Specification
MA	Bus connection with references

7th digit Design Revision Order	
Code	Specification
A	

8th+9th+10th digits Hardware Options Specification		
Code	Specification	Applicable Models
None	Without options	All models
001	Rack-mounted	All models
002	Varnished	All models
020*4	No dynamic brake	SGD7C-1R6A to -2R8A
	External dynamic brake resistor	SGD7C-5R5A to -7R6A
700*5	HWBB option	All models

- *1. You can use these models with either a single-phase or three-phase power supply input.
- *2. If you use the SGD7W-5R5A with a single-phase 200-VAC power supply input, derate the load ratio to 65%. An example is given below.
If the load ratio of the first axis is 90%, use a load ratio of 40% for the second axis so that average load ratio for both axes is 65% ((90% + 40%)/2 = 65%).
- *3. The same SERVOPACKS are used for both Rotary Servomotors and Linear Servomotors.
- *4. Refer to the following manual for details.
□ □ Σ-7 Series AC Servo Drive Σ-7S/Σ-7W SERVOPACK with Hardware Option Specifications Dynamic Brake Product Manual (Manual No.: SIEP S800001 73)
- *5. Refer to the following manual for details.
□ □ Σ-7 Series AC Servo Drive Σ-7W/Σ-7C SERVOPACK with Hardware Option Specifications HWBB Function Product Manual (Manual No.: SIEP S800001 72)



Related Documents

The documents that are related to the MP3300 Machine Controllers and Σ -7 series AC Servo Drives are shown in the following table. Refer to these documents as required.

Catalog (Catalog No.)	Manual (Manual No.)	Description of Document
General Catalog		
Machine Controller and AC Servo Drive Solutions Catalog (KAEP S800001 22)	–	–
MP3300 Catalog	MP3000-Series Manual	Describes the functions, specifications, operating methods, maintenance, inspections, and troubleshooting of the MP3000-Series MP3300 Machine Controllers.
Machine Controller MP3300 (KAEP C880725 03)	MP3300 (SIEP C880725 21)	
Σ-7-Series Catalog	Σ-7-Series SERVOPACK Product Manual	Provide detailed information on selecting Σ -7-Series SERVOPACKs and information on installing, connecting, setting, performing trial operation for, tuning, and monitoring the Servo Drives.
AC Servo Drives Σ -7Series (KAEP S800001 23)	Σ -7S SERVOPACK with MECHATROLINK-III Communications References (SIEP S800001 28)	
	Σ -7S SERVOPACK with MECHATROLINK-II Communications References (SIEP S800001 27)	
	Σ -7S SERVOPACK with Analog Voltage/Pulse Train References (SIEP S800001 26)	
	Σ -7S SERVOPACK Command Option Attachable Type with INDEXER Module (SIEP S800001 64)	
	Σ -7S SERVOPACK Command Option Attachable Type with DeviceNet Module (SIEP S800001 70)	
	Σ -7W SERVOPACK with MECHATROLINK-III Communications References (SIEP S800001 29)	
	Σ -7C SERVOPACK (SIEP S800002 04)	Provides detailed information on selecting Σ -7-Series Σ -7C SERVOPACKs; installing, connecting, setting, testing in trial operation, and tuning Servo Drives; writing, monitoring, and maintaining programs; and other information.
	Σ -7C SERVOPACK Motion Control User's Manual (SIEP S800002 03)	Provides detailed information on the specifications, system configuration, and application methods of the Motion Control Function Modules (SVD, SVC4, and SVR4) for Σ -7-Series Σ -7C SERVOPACKs.
	Machine Controller MP3000 Series Communications User's Manual (SIEP C880725 12)	Provides detailed information on the specifications, system configuration, and communications connection methods for the Ethernet communications that are used with Σ -7-Series Σ -7C SERVOPACKs.

Catalog (Catalog No.)	Manual (Manual No.)	Description of Document
Σ-7-Series Catalog	Σ-7-Series SERVOPACK Product Manual	
AC Servo Drives Σ -7Series (KAEP S800001 23)	Σ -7C SERVOPACK Troubleshooting Manual (SIEP S800002 07)	Provides detailed troubleshooting information for Σ -7-Series Σ -7C SERVOPACKs.
	Σ -7S / Σ -7W SERVOPACK with Hardware Option Specifications Dynamic Brake (SIEP S800001 73)	Provides detailed information on Hardware Options for Σ -7-Series SERVOPACKs.
	Σ -7W / Σ -7C SERVOPACK with Hardware Option Specifications HWBB Function (SIEP S800001 72)	
	Σ -7-Series AC Servo Drive Σ -7S SERVOPACK with Hardware Option Specifications Dynamic Brake (SIEP S800001 91)	Provides detailed information on Options for Σ -7S SERVOPACK with FT/EX Specification.
	Σ -V-Series/ Σ -V-Series for Large- Capacity Models/ Σ -7-Series User's Manual Safety Module (SIEP C720829 06)	Provides details information required for the design and maintenance of a Safety Module.
	Σ-7-Series Servomotor Product Manual	
Rotary Servomotor (SIEP S800001 36)	Provide detailed information on selecting, installing, and connecting the Σ -7-Series Servomotors.	
Linear Servomotor (SIEP S800001 37)		
Direct Drive Servomotor (SIEP S800001 38)		



Related Documents

Catalog (Catalog No.)	Manual (Manual No.)	Description of Document
Σ-7-Series Catalog	Others	
AC Servo Drives Σ-7Series (KAEP S800001 23)	Peripheral Device Selection Manual (SIEP S800001 32)	Describes the peripheral devices for a Σ-7-Series Servo System.
	MECHATROLINK-III Communications Standard Servo Profile Command Manual (SIEP S800001 31)	Provides detailed information on the MECHATROLINK-III communications standard servo profile commands that are used for a Σ-7- Series Servo System.
	MECHATROLINK-II Communications Command Manual (SIEP S800001 30)	Provides detailed information on the MECHATROLINK-II communications commands that are used for a Σ-7-Series Servo System.
	Digital Operator Operating Manual (SIEP S800001 33)	Describes the operating procedures for a Digital Operator for a Σ-7-Series Servo System.
	Engineering Tool SigmaWin+ Operation Manual (SIET S800001 34)	Provides detailed operating procedures for the SigmaWin+ Engineering Tool for a Σ-7-Series Servo System.
	Machine Controller MP2000/MP3000 Series Engineering Tool MPE720 Version 7 User's Manual (SIEP C880761 03)	Describes in detail how to operate MPE720 version 7.
	Machine Controller MP3000 Series Ladder Programming Manual (SIEP C880725 13)	Provides detailed information on the ladder programming specifications and instructions for Σ-7-Series Σ-7C SERVOPACKs.
Machine Controller MP3000 Series Motion Programming Manual (SIEP C880725 14)	Provides detailed information on the motion programming and sequence programming specifications and instructions for Σ-7-Series Σ-7C SERVOPACKs.	



CONTENTS

Rotary Servomotors	
SGMMV (Low Inertia, Ultra-small Size)	4
SGM7J (Medium Inertia, High-speed)	14
SGM7A (Low Inertia, High-speed)	38
SGM7P (Medium Inertia, Flat Type)	74
SGM7G (Medium Inertia, Large Torque)	94
Direct Drive Servomotors	
SGM7D (With Core, Outer Rotor)	118
SGM7E (Coreless, Inner Rotor)	144
SGM7F (With Core, Inner Rotor)	160
SGM7CV (Small Capacity, with Core, Inner Rotor)	182
SGM7CS (Small Capacity, Coreless, Inner Rotor or Medium Capacity, with Core, Inner Rotor)	196
Linear Servomotors	
SGLG (Coreless Models)	218
SGLF (Models with F-type Iron Cores)	242
SGLT (Models with T-type Iron Cores)	282
Recommended Linear Encoders and Cables	308
SERVOPACKs	
Σ -7S Single-axis Analog Voltage/Pulse Train Reference SERVOPACKs	326
Σ -7S Single-axis MECHATROLINK-II Communications Reference SERVOPACKs	336
Σ -7S Single-axis MECHATROLINK-III Communications Reference SERVOPACKs	346
Σ -7S Single-axis SERVOPACKs with INDEXER Module	356
Σ -7S Single-axis SERVOPACKs with DeviceNet Module	370
Σ -7S Single-axis FT82 SERVOPACKs SGM7D Motor Drive	382
Σ -7S Single-axis FT83 SERVOPACKs SGM7D Motor Drive with Built-in INDEXER	402
Σ -7W Two-axis MECHATROLINK-III Communications Reference SERVOPACKs	412
Σ -7C Two-axis Bus Connection Reference SERVOPACKs with built-in Controllers	420
SERVOPACK External Dimensions	436
Peripheral Devices	448
Option Modules	
Feedback Option Module	480
Safety Option Module	486
Appendices	
Capacity Selection for Servomotors	492
Capacity Selection for Regenerative Resistors	500
International Standards	518
Warranty	520

Rotary Servomotors

■ Features



SGMMV (Low Inertia, Ultra Small Size) 4

- Contributes to machine downsizing (flange size: 25 mm × 25 mm).
- Ultra small capacity: 10 W to 30 W and maximum motor speed: 6,000 min⁻¹
- Mounted absolute serial encoder: 17 bits. Can be used as an incremental encoder.



SGM7J (Medium Inertia, High Speed) 14

- Instantaneous peak torque: 350% of rated torque.
- Protective structure: IP67
- Mounted high-resolution serial encoder: 24 bits. Batteryless absolute encoder also provided.
- Full lineup (50 W to 750 W, with holding brake, with gears, and with oil seal).
- Cables can be installed in both load side and non-load side.



SGM7A (Low Inertia, High Speed) 38

- Instantaneous peak torque: 350% of rated torque (for motors of less than 1 kW).
- Protective structure: IP67 (IP22 for 7.0 kW motor)
- Mounted high-resolution serial encoder: 24 bits. Batteryless absolute encoder also provided.
- Full lineup (50 W to 7.0 kW, with holding brake, with gears, and with oil seal).
- Cables can be installed in both load side and non-load side (for motors of less than 1 kW).



SGM7P (Medium Inertia, Flat Type) 74

- Flat type with short depth.
- Mounted high-resolution serial encoder: 24 bits. Batteryless absolute encoder also provided.
- Full lineup (100 W to 1.5 kW, with holding brake, with gears, and with oil seal).



SGM7G (Medium Inertia, Large Torque) 94

- Protective structure: IP67
- Mounted high-resolution serial encoder: 24 bits. Batteryless absolute encoder also provided.
- Full lineup (300 W to 15 kW, with holding brake, and with oil seal).

SGMMV

SGM7J

SGM7A

SGM7P

SGM7G

SGMMV

Model Designations

SGMMV - A1 A 2 A 2 1

1st+2nd digits 3rd digit 4th digit 5th digit 6th digit 7th digit

Σ-V mini Series
Servomotors:
SGMMV

1st+2nd digits Rated Output

Code	Specification
A1	10 W
A2	20 W
A3	30 W

3rd digit Power Supply Voltage

Code	Specification
A	200 VAC

4th digit Serial Encoder

Code	Specification
2	17-bit absolute

5th digit Design Revision Order

A

6th digit Shaft End

Code	Specification
2	Straight (standard)
A	Straight with flat seats (optional)

7th digit Options

Code	Specification
1	Without options
C	With holding brake (24 VDC)

Specifications and Ratings

Specifications

Voltage		200 V		
Model SGMMV-		A1A	A2A	A3A
Time Rating		Continuous		
Thermal Class		B		
Insulation Resistance		500 VDC, 10 M Ω min.		
Withstand Voltage		1,500 VAC for 1 minute		
Excitation		Permanent magnet		
Mounting		Flange-mounted		
Drive Method		Direct drive		
Rotation Direction		Counterclockwise (CCW) for forward reference when viewed from the load side		
Vibration Class* ¹		V15		
Environmental Conditions	Surrounding Air Temperature	0°C to 40°C		
	Surrounding Air Humidity	20% to 80% relative humidity (with no condensation)		
	Installation Site	<ul style="list-style-type: none"> • Must be indoors and free of corrosive and explosive gases. • Must be well-ventilated and free of dust and moisture. • Must facilitate inspection and cleaning. • Must have an altitude of 1,000 m or less. • Must be free of strong magnetic fields. 		
	Storage Environment	Store the Servomotor in the following environment if you store it with the power cable disconnected. Storage Temperature: -20°C to 60°C (with no freezing) Storage Humidity: 20% to 80% relative humidity (with no condensation)		
Shock Resistance* ²	Impact Acceleration Rate at Flange	490 m/s ²		
	Number of Impacts	2 times		
Vibration Resistance* ²	Vibration Acceleration Rate at Flange	49 m/s ²		
Applicable SERVOPACKs	SGD7S-	R90A, R90F		1R6A, 2R1F
	SGD7W-SGD7C-	1R6A* ³ , 2R8A* ³		1R6A, 2R8A* ³

*1. A vibration class of V15 indicates a vibration amplitude of 15 μ m maximum on the Servomotor without a load at the rated motor speed.

*2. The given values are for when the Servomotor shaft is mounted horizontally and shock or vibration is applied in the directions shown in the following figures.

The strength of the vibration that the Servomotor can withstand depends on the application. Always check the vibration acceleration rate that is applied to the Servomotor with the actual equipment.

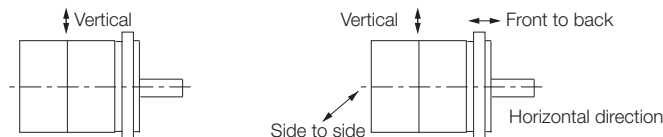

Shock Applied to the Servomotor

Vibration Applied to the Servomotor

*3. If you use a Servomotor together with a Σ -7W or Σ -7C SERVOPACK, the control gain may not increase as much as with a Σ -7S SERVOPACK and other performances may be lower than those achieved with a Σ -7S SERVOPACK.

Servomotor Ratings

Voltage		200 V			
Model SGMMV-		A1A	A2A	A3A	
Rated Output* ¹	W	10	20	30	
Rated Torque* ^{1, *2}	N·m	0.0318	0.0637	0.0955	
Instantaneous Maximum Torque* ¹	N·m	0.0955	0.191	0.286	
Rated Current* ¹	Arms	0.70	0.66	0.98	
Instantaneous Maximum Current* ¹	Arms	2.0	1.9	2.9	
Rated Motor Speed* ¹	min ⁻¹	3000			
Maximum Motor Speed* ¹	min ⁻¹	6000			
Torque Constant	N·m/Arms	0.0516	0.107	0.107	
Motor Moment of Inertia	×10 ⁻⁷ kg·m ²	2.72 (4.07)	4.66 (6.02)	6.68 (8.04)	
Rated Power Rate* ¹	kW/s	3.72	8.71	13.7	
Rated Angular Acceleration Rate* ¹	rad/s ²	117000	137000	143000	
Heat Sink Size (Aluminum)* ³	mm	150×150×3		250×250×6	
Protective Structure* ⁴	Totally enclosed, self-cooled, IP55 (except for shaft opening)				
Holding Brake Specifications* ⁵	Rated Voltage	V	24 VDC ^{+10%} ₀		
	Capacity	W	2.0	2.6	
	Holding Torque	N·m	0.0318	0.0637	0.0955
	Coil Resistance	Ω (at 20°C)	320	221.5	
	Rated Current	A (at 20°C)	0.075	0.108	
	Time Required to Release Brake	ms	40		
	Time Required to Brake	ms	100		
Allowable Load Moment of Inertia (Motor Moment of Inertia Ratio)* ⁶	30 times				
	With External Regenerative Resistor	30 times			
Allowable Shaft Loads* ⁷	LF	mm	16		
	Allowable Radial Load	N	34	44	
	Allowable Thrust Load	N	14.5		

Note: The values in parentheses are for Servomotors with Holding Brakes.

*1. These values are for operation in combination with a SERVOPACK when the temperature of the armature winding is 100°C. These are typical values.

*2. The rated torques are the continuous allowable torque values with an aluminum or steel heat sink of the dimensions given in the table.

*3. Refer to the following section for the relation between the heat sinks and derating rate.

 **Servomotor Heat Dissipation Conditions (page 9)**

*4. This does not apply to the shaft opening. Protective structure specifications apply only when the special cable is used.

*5. Observe the following precautions if you use a Servomotor with a Holding Brake.

- The holding brake cannot be used to stop the Servomotor.
- The time required to release the brake and the time required to brake depend on which discharge circuit is used. Confirm that the operation delay time is appropriate for the actual equipment.
- The 24-VDC power supply is not provided by Yaskawa.

*6. The motor moment of inertia scaling factor is the value for a standard Servomotor without a Holding Brake.

*7. Design the mechanical system so that the thrust and radial loads applied to the Servomotor shaft end during operation do not exceed the values given in the table.

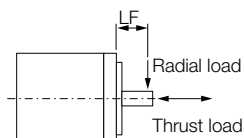

Torque-Motor Speed Characteristics

- A** : Continuous duty zone
- B** : Intermittent duty zone*

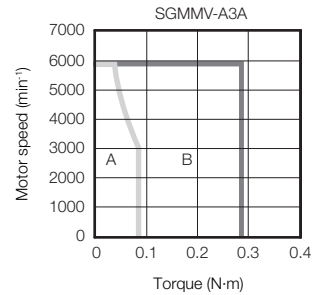
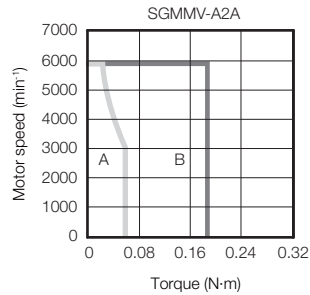
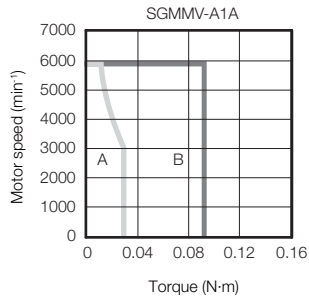

* The characteristics are the same for three-phase 200 V, single-phase 200 V, and single-phase 100 V input.

- Note: 1. These values (typical values) are for operation in combination with a SERVOPACK when the temperature of the armature winding is 100°C.
2. The characteristics in the intermittent duty zone depend on the power supply voltage.
 3. If the effective torque is within the allowable range for the rated torque, the Servomotor can be used within the intermittent duty zone.
 4. If you use a Servomotor Main Circuit Cable that exceeds 20 m, the intermittent duty zone in the torque-motor speed characteristics will become smaller because the voltage drop increases.

Servomotor Overload Protection Characteristics

The overload detection level is set for hot start conditions with a Servomotor surrounding air temperature of 40°C.

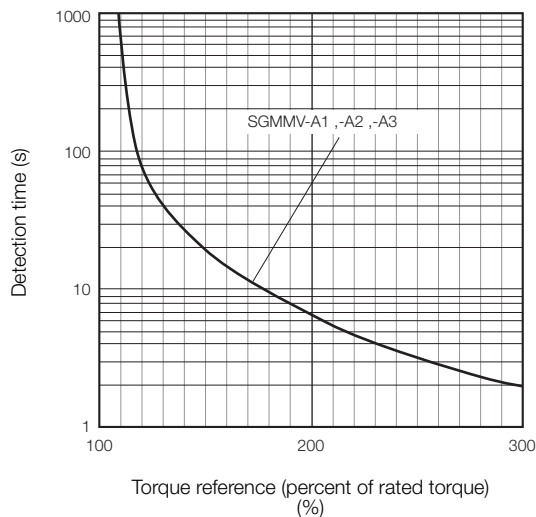

Note: The above overload protection characteristics do not mean that you can perform continuous duty operation with an output of 100% or higher. Use the Servomotor so that the effective torque remains within the continuous duty zone given in *Torque-Motor Speed Characteristics* (page 7).

Allowable Load Moment of Inertia

The allowable load moments of inertia (motor moment of inertia ratios) for the Servomotors are given in the *Servomotor Ratings* (page 6). The values are determined by the regenerative energy processing capacity of the SERVOPACK and are also affected by the drive conditions of the Servomotor. Perform the required Steps for each of the following cases.

Use the SigmaSize+ AC Servo Drive Capacity Selection Program to check the driving conditions. Contact your Yaskawa representative for information on this program.

◆ Exceeding the Allowable Load Moment of Inertia

Use one of the following measures to adjust the load moment of inertia to within the allowable value.

- Reduce the torque limit.
- Reduce the deceleration rate.
- Reduce the maximum motor speed.

If the above steps is not possible, install an external regenerative resistor.

Information An Overvoltage Alarm (A.400) is likely to occur during deceleration if the load moment of inertia exceeds the allowable load moment of inertia. SERVOPACKs with a built-in regenerative resistor may generate a Regenerative Overload Alarm (A.320). Refer to *Built-In Regenerative Resistor* (page 472) for the regenerative power (W) that can be processed by the SERVOPACKs.
Install an External Regenerative Resistor when the built-in regenerative resistor cannot process all of the regenerative power.

◆ SERVOPACKs without Built-in Regenerative Resistors

The following graph shows the allowable load moment of inertia scaling factor of the motor speed (reference values for deceleration operation at or above the rated torque). Application is possible without an external regenerative resistor within the allowable value. However, an External Regenerative Resistor is required in the shaded areas of the graphs.

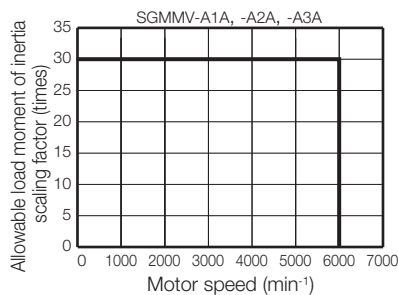

Note: Applicable SERVOPACK models: SGD7S-R90A, -1R6A, -R90F, and -2R1F

◆ When an External Regenerative Resistor Is Required

Install the External Regenerative Resistor. Refer to the following section for the recommended products.

External Regenerative Resistors (page 472)

Derating Rates

◆ Servomotor Heat Dissipation Conditions

The Servomotor ratings are the continuous allowable values when a heat sink is installed on the Servomotor. If the Servomotor is mounted on a small device component, the Servomotor temperature may rise considerably because the surface for heat dissipation becomes smaller. Refer to the following graphs for the relation between the heat sink size and derating rate.

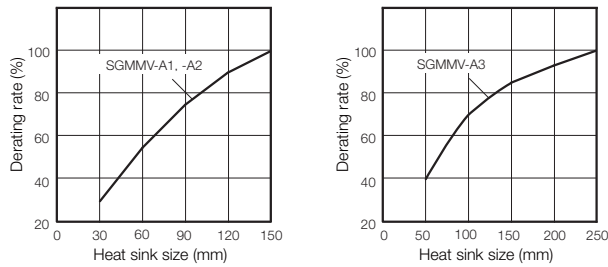

Important

The actual temperature rise depends on how the heat sink (i.e., the Servomotor mounting section) is attached to the installation surface, what material is used for the Servomotor mounting section, and the motor speed. Always check the Servomotor temperature with the actual equipment.

Information

When using Servomotors with derating, change the detection timing of overload warning and overload alarm based on the overload detection level of the motor given in *Servomotor Overload Protection Characteristics* (page 7).

Note: The derating rates are applicable only when the average motor speed is less than or equal to the rated motor speed. If the average motor speed exceeds the rated motor speed, consult with your Yaskawa representative.

External Dimensions

Servomotors without Holding Brakes

◆ SGMMV-A1, -A2 and -A3

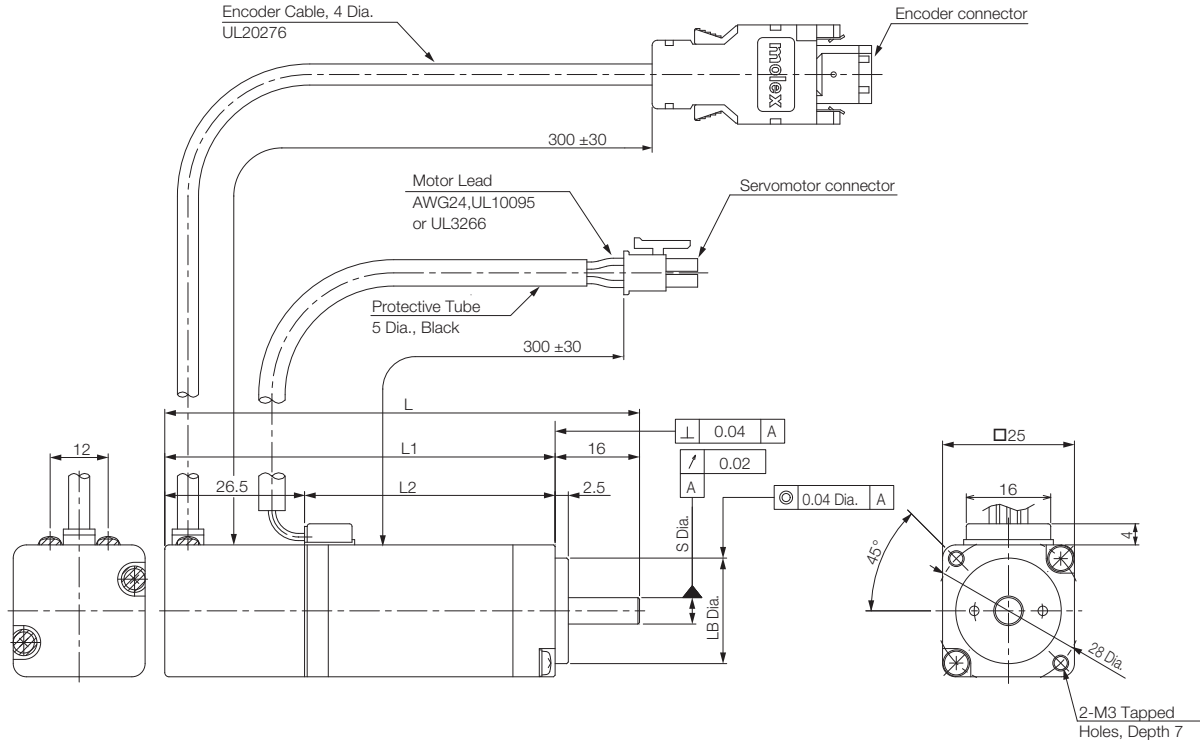

Model SGMMV-	L	L1	L2	Flange Dimensions		Approx. Mass [kg]
				S	LB	
A1A2A□1	70	54	27.5	5 ⁰ _{-0.008}	20 ⁰ _{-0.021}	0.13
A2A2A□1	80	64	37.5	5 ⁰ _{-0.008}	20 ⁰ _{-0.021}	0.17
A3A2A□1	90	74	47.5	5 ⁰ _{-0.008}	20 ⁰ _{-0.021}	0.21

■ Shaft End Specification

- Straight with Flat Seats

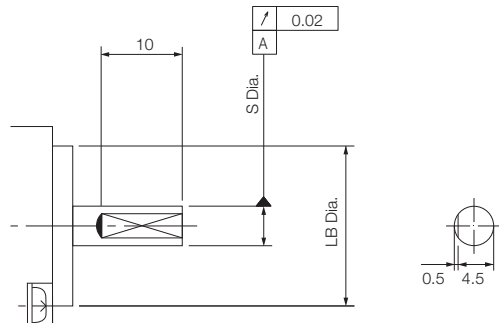

■ Connector Specifications

• Encoder Connector

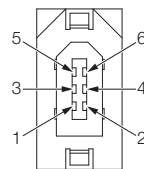

1	PG5V	Red
2	PG0V	Black
3*	BAT	Orange
4*	BAT0	Orange/white
5	PS	Light blue
6	/PS	Light blue/white
Connector case	FG (frame ground)	Shield

* A battery is required only for an absolute encoder.

Model: 55102-0600

Manufacturer: Molex Japan LLC

Mating connector: 54280-0609

• Servomotor Connector

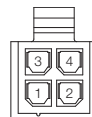

1	Phase U
2	Phase V
3	Phase W
4	FG (frame ground)

Receptacle: 43025-0400

Manufacturer: Molex Japan LLC

Servomotors with Holding Brakes

◆ SGMMV-A1, -A2 and -A3

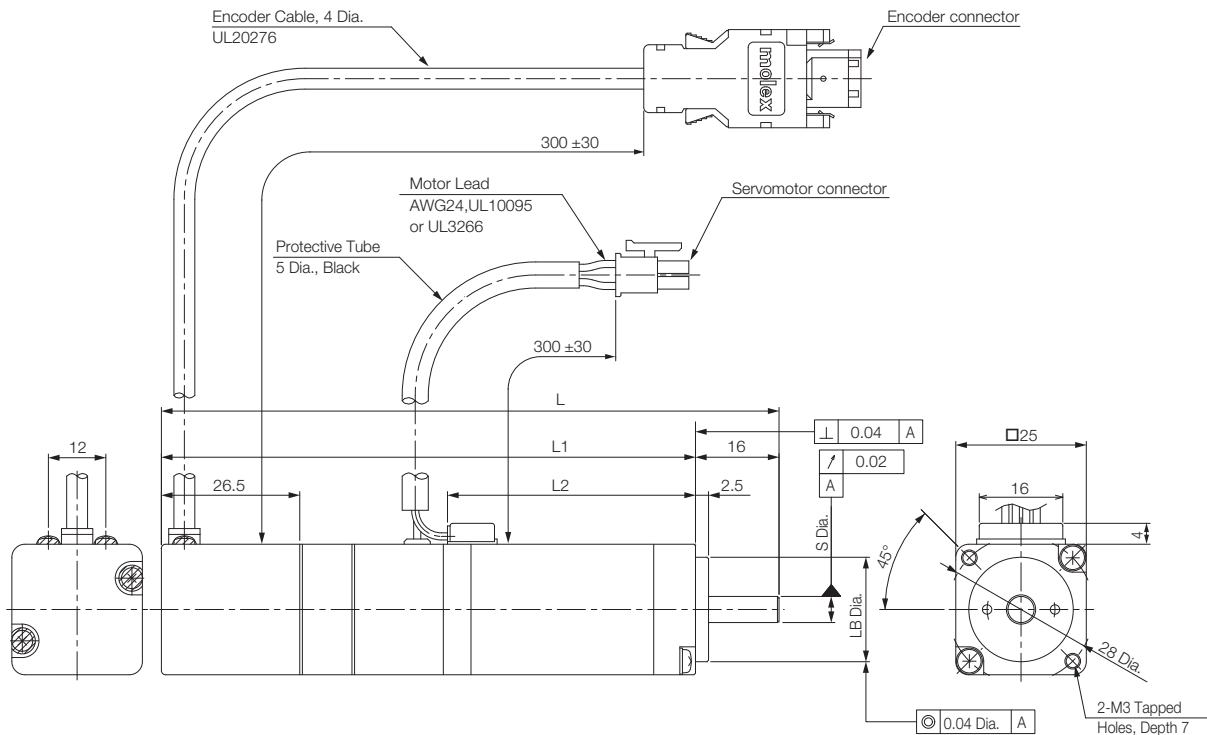

Model SGMMV-	L	L1	L2	Flange Dimensions		Approx. Mass [kg]
				S	LB	
A1A2A□C	94.5	78.5	27.5	5 ⁰ _{-0.008}	20 ⁰ _{-0.021}	0.215
A2A2A□C	108.5	92.5	37.5	5 ⁰ _{-0.008}	20 ⁰ _{-0.021}	0.27
A3A2A□C	118.5	102.5	47.5	5 ⁰ _{-0.008}	20 ⁰ _{-0.021}	0.31

■ Shaft End Specification

- Straight with Flat Seats

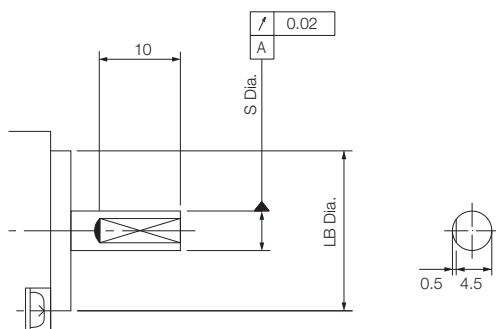

■ Connector Specifications

- Encoder Connector

1	PG5V	Red
2	PG0V	Black
3*	BAT	Orange
4*	BAT0	Orange/white
5	PS	Light blue
6	/PS	Light blue/white
Connector case	FG (frame ground)	Shield

* A battery is required only for an absolute encoder.

Model: 55102-0600

Manufacturer: Molex Japan LLC

Mating connector: 54280-0609

- Servomotor Connector

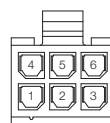

1	Phase U
2	Phase V
3	Phase W
4	FG (frame ground)
5	Brake
6	Brake

Receptacle: 43025-0600

Manufacturer: Molex Japan LLC

Selecting Cables

◆ Cable Configurations

The cables shown below are required to connect a Servomotor to a SERVOPACK.

Encoder Cable of 20 m or Less

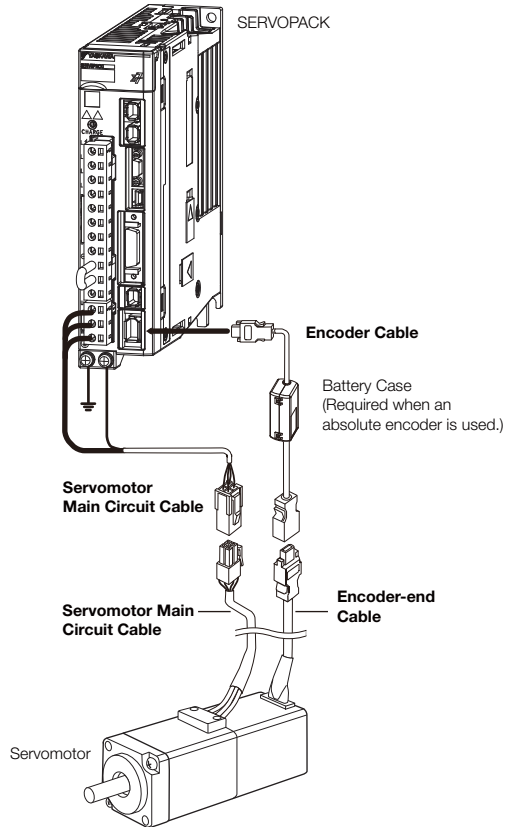

Encoder Cable of 30 m to 50 m (Relay Cable)

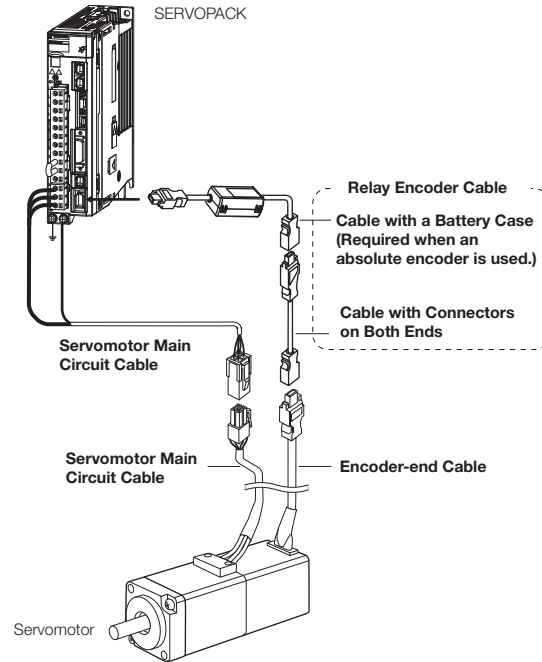

Note: 1. If the Encoder Cable length exceeds 20 m, be sure to use a Relay Encoder Cable.

2. If you use a Servomotor Main Circuit Cable that exceeds 20 m, the intermittent duty zone in the torque-motor speed characteristics will become smaller because the voltage drop increases.

3. Refer to the following manual for the following information.

- Cable dimensional drawings and cable connection specifications
- Order numbers and specifications of individual connectors for cables
- Order numbers and specifications for wiring materials

📖 *Σ-7-Series AC Servo Drive Peripheral Device Selection Manual (Manual No.: SIEP S800001 32)*

◆ Servomotor Main Circuit Cables

Name	Length (L)	Order Number		Appearance
		Standard Cable	Flexible Cable*	
For Servomotors without Holding Brakes	3 m	JZSP-CF2M00-03-E	JZSP-CF2M20-03-E	
	5 m	JZSP-CF2M00-05-E	JZSP-CF2M20-05-E	
	10 m	JZSP-CF2M00-10-E	JZSP-CF2M20-10-E	
	15 m	JZSP-CF2M00-15-E	JZSP-CF2M20-15-E	
	20 m	JZSP-CF2M00-20-E	JZSP-CF2M20-20-E	
	30 m	JZSP-CF2M00-30-E	JZSP-CF2M20-30-E	
	40 m	JZSP-CF2M00-40-E	JZSP-CF2M20-40-E	
50 m	JZSP-CF2M00-50-E	JZSP-CF2M20-50-E		
For Servomotors with Holding Brakes	3 m	JZSP-CF2M03-03-E	JZSP-CF2M23-03-E	
	5 m	JZSP-CF2M03-05-E	JZSP-CF2M23-05-E	
	10 m	JZSP-CF2M03-10-E	JZSP-CF2M23-10-E	
	15 m	JZSP-CF2M03-15-E	JZSP-CF2M23-15-E	
	20 m	JZSP-CF2M03-20-E	JZSP-CF2M23-20-E	
	30 m	JZSP-CF2M03-30-E	JZSP-CF2M23-30-E	
	40 m	JZSP-CF2M03-40-E	JZSP-CF2M23-40-E	
50 m	JZSP-CF2M03-50-E	JZSP-CF2M23-50-E		

* Use Flexible Cables for moving parts of machines, such as robots. The recommended bending radius (R) is 90 mm or larger.

◆ Encoder Cables of 20 m or Less

Name	Length (L)	Order Number		Appearance
		Standard Cable	Flexible Cable*	
Cables with Connectors on Both Ends (for incremental encoder)	3 m	JZSP-CMP00-03-E	JZSP-CMP10-03-E	
	5 m	JZSP-CMP00-05-E	JZSP-CMP10-05-E	
	10 m	JZSP-CMP00-10-E	JZSP-CMP10-10-E	
	15 m	JZSP-CMP00-15-E	JZSP-CMP10-15-E	
	20 m	JZSP-CMP00-20-E	JZSP-CMP10-20-E	
Cables with Connectors on Both Ends (for absolute encoder: With Battery Case)	3 m	JZSP-CSP19-03-E	JZSP-CSP29-03-E	
	5 m	JZSP-CSP19-05-E	JZSP-CSP29-05-E	
	10 m	JZSP-CSP19-10-E	JZSP-CSP29-10-E	
	15 m	JZSP-CSP19-15-E	JZSP-CSP29-15-E	
	20 m	JZSP-CSP19-20-E	JZSP-CSP29-20-E	

* Use Flexible Cables for moving parts of machines, such as robots. The recommended bending radius (R) is 68 mm or larger.

◆ Relay Encoder Cables of 30 m to 50 m

Name	Length (L)	Order Number	Appearance
Cables with Connectors on Both Ends (for incremental or absolute encoder)	30 m	JZSP-UCMP00-30-E	
	40 m	JZSP-UCMP00-40-E	
	50 m	JZSP-UCMP00-50-E	
Cable with a Battery Case (Required when an absolute encoder is used.)*	0.3 m	JZSP-CSP12-E	

* This Cable is not required if a battery is connected to the host controller.

SGM7J

Model Designations

Without Gears

SGM7J - 01 A 7 A 2 1

1st+2nd digits 3rd digit 4th digit 5th digit 6th digit 7th digit

Σ-7 Series
Servomotors:
SGM7J

1st+2nd digits Rated Output

Code	Specification
A5	50 W
01	100 W
C2	150 W
02	200 W
04	400 W
06	600 W
08	750 W

3rd digit Power Supply Voltage

Code	Specification
A	200 VAC

4th digit Serial Encoder

Code	Specification
6	24-bit batteryless absolute
7	24-bit absolute
F	24-bit incremental

5th digit Design Revision Order

A

6th digit Shaft End

Code	Specification
2	Straight without key
6	Straight with key and tap
B	With two flat seats

7th digit Options

Code	Specification
1	Without options
C	With holding brake (24 VDC)
E	With oil seal and holding brake (24 VDC)
S	With oil seal

With Gears

SGM7J - 01 A 7 A H 1 2 1

1st+2nd digits 3rd digit 4th digit 5th digit 6th digit 7th digit 8th digit 9th digit

Σ-7 Series
Servomotors:
SGM7J

1st+2nd digits Rated Output

Code	Specification
A5	50 W
01	100 W
C2	150 W
02	200 W
04	400 W
06	600 W
08	750 W

5th digit Design Revision Order

A

6th digit Gear Type

Code	Specification
H	HDS planetary low-backlash gear

7th digit Gear Ratio

Code	Specification
B	1/11 ^{*1}
C	1/21
1	1/5
2	1/9 ^{*2}
7	1/33

8th digit Shaft End

Code	Specification
0	Flange output
2	Straight without key
6	Straight with key and tap

9th digit Options

Code	Specification
1	Without options
C	With holding brake (24 VDC)

3rd digit Power Supply Voltage

Code	Specification
A	200 VAC

4th digit Serial Encoder

Code	Specification
6	24-bit batteryless absolute
7	24-bit absolute
F	24-bit incremental

*1. This specification is not supported for models with a rated output of 50 W.

*2. This specification is supported only for models with a rated output of 50 W.

Specifications and Ratings

Specifications

Voltage		200 V						
Model SGM7J-		A5A	01A	C2A	02A	04A	06A	08A
Time Rating		Continuous						
Thermal Class		UL: B, CE: B						
Insulation Resistance		500 VDC, 10 M Ω min.						
Withstand Voltage		1,500 VAC for 1 minute						
Excitation		Permanent magnet						
Mounting		Flange-mounted						
Drive Method		Direct drive						
Rotation Direction		Counterclockwise (CCW) for forward reference when viewed from the load side						
Vibration Class* ¹		V15						
Environmental Conditions	Surrounding Air Temperature	0°C to 40°C (With derating, usage is possible between 40°C and 60°C.)* ³						
	Surrounding Air Humidity	20% to 80% relative humidity (with no condensation)						
	Installation Site	<ul style="list-style-type: none"> • Must be indoors and free of corrosive and explosive gases. • Must be well-ventilated and free of dust and moisture. • Must facilitate inspection and cleaning. • Must have an altitude of 1,000 m or less. (With derating, usage is possible between 1,000 m and 2,000 m.)*³ • Must be free of strong magnetic fields. 						
	Storage Environment	Store the Servomotor in the following environment if you store it with the power cable disconnected. Storage Temperature: -20°C to 60°C (with no freezing) Storage Humidity: 20% to 80% relative humidity (with no condensation)						
Shock Resistance* ²	Impact Acceleration Rate at Flange	490 m/s ²						
	Number of Impacts	2 times						
Vibration Resistance* ²	Vibration Acceleration Rate at Flange	49 m/s ²						
Applicable SERVO-PACKs	SGD7S-	R70A, R70F	R90A, R90F	1R6A, 2R1F		2R8A, 2R8F	5R5A	
	SGD7W-SGD7C-	1R6A* ⁴ , 2R8A* ⁴		1R6A, 2R8A* ⁴		2R8A, 5R5A* ⁴ , 7R6A* ⁴	5R5A, 7R6A	

*1. A vibration class of V15 indicates a vibration amplitude of 15 μ m maximum on the Servomotor without a load at the rated motor speed.

*2. The given values are for when the Servomotor shaft is mounted horizontally and shock or vibration is applied in the directions shown in the following figures.

The strength of the vibration that the Servomotor can withstand depends on the application. Always check the vibration acceleration rate that is applied to the Servomotor with the actual equipment.

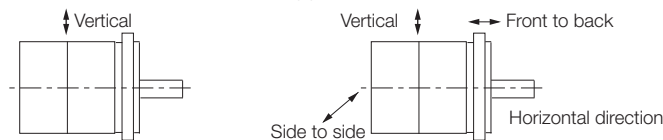

*3. Refer to the following section for the derating rates.

 **Derating Rates** (page 22)

*4. If you use a Servomotor together with a Σ -7W or Σ -7C SERVOPACK, the control gain may not increase as much as with a Σ -7S SERVOPACK and other performances may be lower than those achieved with a Σ -7S SERVOPACK.

Ratings of Servomotors without Gears

Voltage		200 V							
Model SGM7J-		A5A	01A	C2A	02A	04A	06A	08A	
Rated Output* ¹	W	50	100	150	200	400	600	750	
Rated Torque* ^{1, *2}	N·m	0.159	0.318	0.477	0.637	1.27	1.91	2.39	
Instantaneous Maximum Torque* ¹	N·m	0.557	1.11	1.67	2.23	4.46	6.69	8.36	
Rated Current* ¹	Arms	0.55	0.85	1.6	1.6	2.5	4.2	4.4	
Instantaneous Maximum Current* ¹	Arms	2.0	3.1	5.7	5.8	9.3	15.3	16.9	
Rated Motor Speed* ¹	min ⁻¹	3000							
Maximum Motor Speed* ¹	min ⁻¹	6000							
Torque Constant	N·m/Arms	0.316	0.413	0.321	0.444	0.544	0.493	0.584	
Motor Moment of Inertia		0.0395	0.0659	0.0915	0.263	0.486	0.800	1.59	
	With holding brake	×10 ⁻⁴ kg·m ²	0.0475	0.0739	0.0995	0.333	0.556	0.870	1.77
	With batteryless absolute encoder		0.0410	0.0674	0.0930	0.264	0.487	0.801	1.59
Rated Power Rate* ¹		6.40	15.3	24.8	15.4	33.1	45.6	35.9	
	With holding brake	kW/s	5.32	13.6	22.8	12.1	29.0	41.9	32.2
Rated Angular Acceleration Rate* ¹		40200	48200	52100	24200	26100	23800	15000	
	With holding brake	rad/s ²	33400	43000	47900	19100	22800	21900	13500
Derating Rate for Servomotor with Oil Seal	%	80	90			95			
Heat Sink Size (Aluminum)* ³	mm	200 × 200 × 6			250 × 250 × 6				
Protective Structure* ⁴		Totally enclosed, self-cooled, IP67							
Holding Brake Specifications* ⁵	Rated Voltage	V	24 VDC±10%						
	Capacity	W	5.5		6		6.5		
	Holding Torque	N·m	0.159	0.318	0.477	0.637	1.27	1.91	2.39
	Coil Resistance	Ω (at 20°C)	104.8±10%			96±10%		88.6±10%	
	Rated Current	A (at 20°C)	0.23			0.25		0.27	
	Time Required to Release Brake	ms	60					80	
	Time Required to Brake	ms	100						
Allowable Load Moment of Inertia (Motor Moment of Inertia Ratio)* ⁶		35 times			15 times	10 times	20 times	12 times	
	With External Regenerative Resistor and External Dynamic Brake Resistor* ⁷	35 times			25 times		20 times	15 times	
Allowable Shaft Loads* ³	LF	mm	20			25		35	
	Allowable Radial Load	N	78			245		392	
	Allowable Thrust Load	N	54			74		147	

*1. These values are for operation in combination with a SERVOPACK when the temperature of the armature winding is 100°C. The values for other items are at 20°C. These are typical values.

*2. The rated torques are the continuous allowable torque values at a surrounding air temperature of 40°C with an aluminum heat sink of the dimensions given in the table.

*3. Refer to the following section for the relation between the heat sinks and derating rate.

 **Servomotor Heat Dissipation Conditions (page 22)**

*4. This does not apply to the shaft opening. Protective structure specifications apply only when the special cable is used.

*5. Observe the following precautions if you use a Servomotor with a Holding Brake.

- The holding brake cannot be used to stop the Servomotor.
- The time required to release the brake and the time required to brake depend on which discharge circuit is used. Confirm that the operation delay time is appropriate for the actual equipment.
- The 24-VDC power supply is not provided by Yaskawa.

*6. The motor moment of inertia scaling factor is the value for a standard Servomotor without a Holding Brake.

*7. To externally connect a dynamic brake resistor, select hardware option specification 020 for the SERVOPACK. However, you cannot externally connect a dynamic brake resistor if you use the following SERVOPACKs (maximum applicable motor capacity: 400 W).

- SGD7S-R70□□□A020 to -2R8□□□A020
- SGD7W-1R6A20A020 to -2R8A20A020
- SGD7C-1R6AMAA020 to -2R8AMAA020

*8. Design the mechanical system so that the thrust and radial loads applied to the Servomotor shaft end during operation do not exceed the values given in the table.

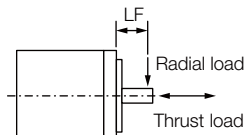

Torque-Motor Speed Characteristics

A : Continuous duty zone ——— (solid lines): With three-phase 200-V or single-phase 230-V input
B : Intermittent duty zone - - - - (dotted lines): With single-phase 200-V input
 - · - · - (dashed-dotted lines): With single-phase 100-V input

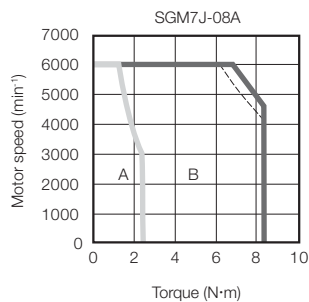
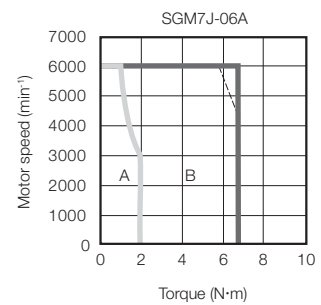
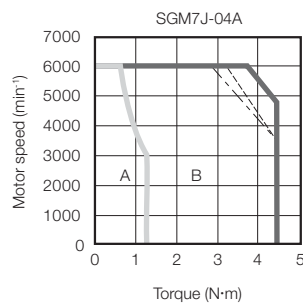
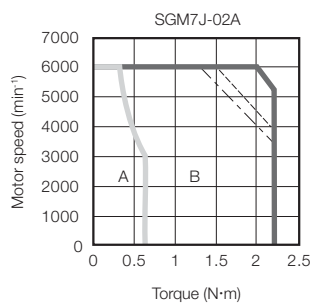
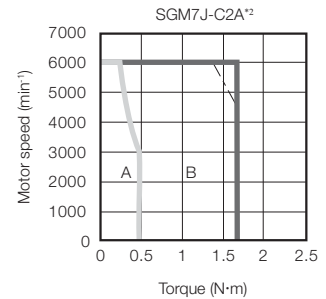
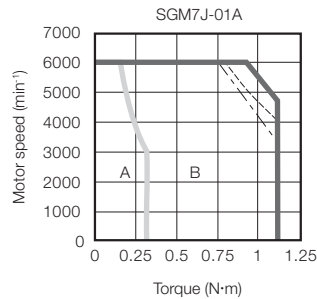
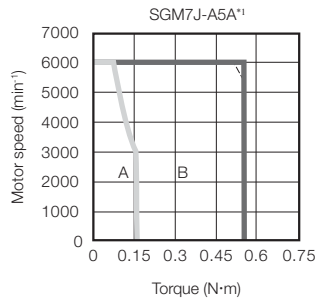

*1. The characteristics are the same for single-phase 200 V and single-phase 100 V input.

*2. The characteristics are the same for three-phase 200 V and single-phase 200 V input.

Note: 1. These values (typical values) are for operation in combination with a SERVOPACK when the temperature of the armature winding is 100°C.

2. The characteristics in the intermittent duty zone depend on the power supply voltage.
3. If the effective torque is within the allowable range for the rated torque, the Servomotor can be used within the intermittent duty zone.
4. If you use a Servomotor Main Circuit Cable that exceeds 20 m, the intermittent duty zone in the torque-motor speed characteristics will become smaller because the voltage drop increases.

Ratings of Servomotors with Gears

All Models	Gear Mechanism		Protective Structure		Lost Motion [arc-min]	
	Planetary gear mechanism		Totally enclosed, self-cooled, IP55 (except for shaft opening)		3 max.	

Servomotor Model SGM7J-	Servomotor					Gear Output				
	Rated Output [W]	Rated Motor Speed [min ⁻¹]	Maximum Motor Speed [min ⁻¹]	Rated Torque [N·m]	Instantaneous Maximum Torque [N·m]	Gear Ratio	Rated Torque/ Efficiency ^{*1} [N·m/%]	Instantaneous Maximum Torque [N·m]	Rated Motor Speed [min ⁻¹]	Maximum Motor Speed [min ⁻¹]
A5A□AH1□	50	3000	6000	0.159	0.557	1/5	0.433/64 ^{*2}	2.37	600	1200
A5A□AH2□						1/9	1.12/78	3.78 ^{*3}	333	667
A5A□AHC□						1/21	2.84/85	10.6	143	286
A5A□AH7□						1/33	3.68/70	15.8	91	182
01A□AH1□	100	3000	6000	0.318	1.11	1/5	1.06/78 ^{*2}	4.96	600	1200
01A□AHB□						1/11	2.52/72	10.7	273	545
01A□AHC□						1/21	5.35/80	20.8	143	286
01A□AH7□						1/33	7.35/70	32.7	91	182
C2A□AH1□	150	3000	6000	0.477	1.67	1/5	1.68/83 ^{*2}	7.80	600	1200
C2A□AHB□						1/11	3.53/79 ^{*2}	16.9	273	545
C2A□AHC□						1/21	6.30/70 ^{*2}	31.0	143	286
C2A□AH7□						1/33	11.2/79 ^{*2}	49.7	91	182
02A□AH1□	200	3000	6000	0.637	2.23	1/5	2.39/75	9.80	600	1200
02A□AHB□						1/11	5.74/82	22.1	273	545
02A□AHC□						1/21	10.2/76	42.1	143	286
02A□AH7□						1/33	17.0/81	67.6	91	182
04A□AH1□	400	3000	6000	1.27	4.46	1/5	5.35/84	20.1	600	1200
04A□AHB□						1/11	11.5/82	45.1	273	545
04A□AHC□						1/21	23.0/86	87.0	143	286
04A□AH7□						1/33	34.0/81	135	91	182
06A□AH1□	600	3000	6000	1.91	6.69	1/5	7.54/79	30.5	600	1200
06A□AHB□						1/11	18.1/86	68.6	273	545
06A□AHC□						1/21	32.1/80	129	143	286
06A□AH7□						1/33	53.6/85	206	91	182
08A□AH1□	750	3000	6000	2.39	8.36	1/5	10.0/84	38.4	600	1200
08A□AHB□						1/11	23.1/88	86.4	273	545
08A□AHC□						1/21	42.1/84	163	143	286
08A□AH7□						1/33	69.3/88	259	91	182

*1. The gear output torque is expressed by the following formula.

$$\text{Gear output torque} = \text{Servomotor output torque} \times \frac{1}{\text{Gear ratio}} \times \text{Efficiency}$$

The gear efficiency depends on operating conditions such as the output torque, motor speed, and temperature. The values in the table are typical values for the rated torque, rated motor speed, and a surrounding air temperature of 25°C. They are reference values only.

*2. When using an SGM7J-A5A, SGM7J-01A, or SGM7J-C2A Servomotor with a gear ratio of 1/5 or an SGM7J-C2A Servomotor with a gear ratio of 1/11, maintain an 85% maximum effective load ratio. For an SGM7J-C2A Servomotor with a gear ratio of 1/21 or 1/33, maintain a 90% maximum effective load ratio. The values in the table take the effective load ratio into consideration.

*3. The instantaneous maximum torque is 300% of the rated torque.

Note: 1. The gears that are mounted to Yaskawa Servomotors have not been broken in.

Break in the Servomotor if necessary. First, operate the Servomotor at low speed with no load. If no problems occur, gradually increase the speed and load.

2. The no-load torque for a Servomotor with a Gear is high immediately after the Servomotor starts, and it then decreases and becomes stable after a few minutes.

This is a common phenomenon caused by grease circulation in the gears and it does not indicate faulty gears.

3. Other specifications are the same as those for Servomotors without Gears.



Important

The SERVOPACK speed control range is 1:5,000. If you use Servomotors at extremely low speeds (0.02 min⁻¹ or lower at the gear output shaft), if you use Servomotors with a one-pulse feed reference for extended periods, or under some other operating conditions, the gear bearing lubrication may be insufficient. That may cause deterioration of the bearing or increase the load ratio. Contact your Yaskawa representative if you use a Servomotor under these conditions.

Servomotor Model SGM7J-	Moment of Inertia [$\times 10^{-4}$ kg·m ²]				With Gears			Reference Diagram
	Shaft Output		Flange Output		Allowable Radial Load [N]	Allowable Thrust Load [N]	LF [mm]	
	Motor* + Gear	Gear	Motor* + Gear	Gear				
A5A□AH1□	0.0455	0.006	0.0445	0.005	95	431	37	
A5A□AH2□	0.0425	0.003	0.0425	0.003	113	514	37	
A5A□AHC□	0.0435	0.004	0.0435	0.004	146	663	37	
A5A□AH7□	0.0845	0.045	0.0845	0.045	267	1246	53	
01A□AH1□	0.0719	0.006	0.0709	0.005	95	431	37	
01A□AHB□	0.126	0.060	0.125	0.059	192	895	53	
01A□AHC□	0.116	0.050	0.116	0.050	233	1087	53	
01A□AH7□	0.131	0.065	0.130	0.064	605	2581	75	
C2A□AH1□	0.0975	0.006	0.0965	0.005	95	431	37	
C2A□AHB□	0.152	0.060	0.151	0.059	192	895	53	
C2A□AHC□	0.202	0.110	0.200	0.108	528	2254	75	
C2A□AH7□	0.157	0.065	0.156	0.064	605	2581	75	
02A□AH1□	0.470	0.207	0.464	0.201	152	707	53	
02A□AHB□	0.456	0.193	0.455	0.192	192	895	53	
02A□AHC□	0.753	0.490	0.751	0.488	528	2254	75	
02A□AH7□	0.713	0.450	0.712	0.449	605	2581	75	
04A□AH1□	0.693	0.207	0.687	0.201	152	707	53	
04A□AHB□	1.06	0.570	1.05	0.560	435	1856	75	
04A□AHC□	0.976	0.490	0.974	0.488	528	2254	75	
04A□AH7□	1.11	0.620	1.10	0.610	951	4992	128	
06A□AH1□	1.50	0.700	1.46	0.660	343	1465	75	
06A□AHB□	1.37	0.570	1.36	0.560	435	1856	75	
06A□AHC□	1.64	0.840	1.62	0.820	830	4359	128	
06A□AH7□	1.42	0.620	1.41	0.610	951	4992	128	
08A□AH1□	2.29	0.700	2.25	0.660	343	1465	75	
08A□AHB□	2.19	0.600	2.18	0.590	435	1856	75	
08A□AHC□	4.59	3.00	4.57	2.98	830	4359	128	
08A□AH7□	4.39	2.80	4.37	2.78	951	4992	128	

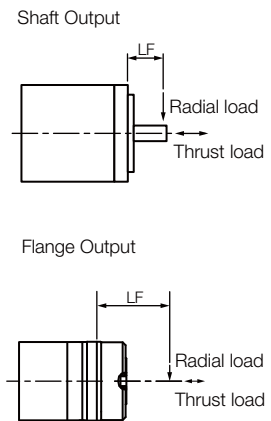

* The moment of inertia for the Servomotor and gear is the value without a holding brake. You can calculate the moment of inertia for a Servomotor with a Gear and Holding Brake with the following formula.

Motor moment of inertia for a Servomotor with a Holding Brake from *Ratings of Servomotors without Gears* (page 16) + Moment of inertia for the gear from the above table.



Important

During operation, the gear generates the loss at the gear mechanism and oil seal. The loss depends on the torque and motor speed conditions. The temperature rise depends on the loss and heat dissipation conditions. For the heat dissipation conditions, always refer to the following table and check the gear and motor temperatures with the actual equipment. If the temperature is too high, implement the following measures.

- Decrease the load ratio.
- Change the heat dissipation conditions.
- Use forced-air cooling for the motor with a cooling fan or other means.

Model	Heat Sink Size			
	1/5	1/9 or 1/11	1/21	1/33
SGM7J-A5	A			
SGM7J-01	A			
SGM7J-C2	B			
SGM7J-02	B			
SGM7J-04	B			
SGM7J-06	C			
SGM7J-08	C			

- A: 250 mm × 250 mm × 6 mm, aluminum plate
- B: 300 mm × 300 mm × 12 mm, aluminum plate
- C: 350 mm × 350 mm × 12 mm, aluminum plate

Servomotor Overload Protection Characteristics

The overload detection level is set for hot start conditions with a Servomotor surrounding air temperature of 40°C.

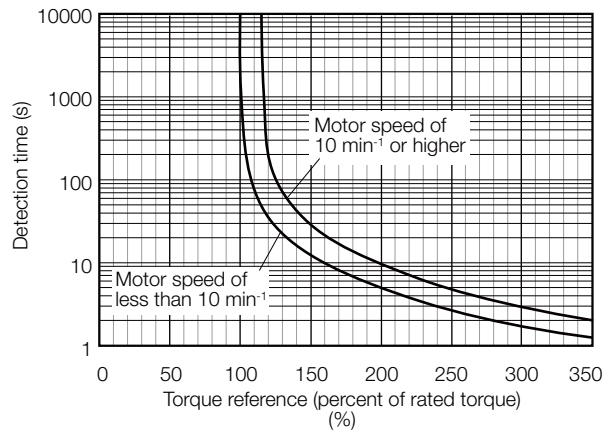

Note: The above overload protection characteristics do not mean that you can perform continuous duty operation with an output of 100% or higher. Use the Servomotor so that the effective torque remains within the continuous duty zone given in *Torque-Motor Speed Characteristics* on page 17.

Allowable Load Moment of Inertia

The allowable load moments of inertia (motor moment of inertia ratios) for the Servomotors are given in the *Ratings of Servomotors without Gears* (page 16). The values are determined by the regenerative energy processing capacity of the SERVOPACK and are also affected by the drive conditions of the Servomotor. Perform the required Steps for each of the following cases.

Use the SigmaSize+ AC Servo Drive Capacity Selection Program to check the driving conditions. Contact your Yaskawa representative for information on this program.

◆ Exceeding the Allowable Load Moment of Inertia

Use one of the following measures to adjust the load moment of inertia to within the allowable value.

- Reduce the torque limit.
- Reduce the deceleration rate.
- Reduce the maximum motor speed.

If the above steps is not possible, install an external regenerative resistor.

Information An Overvoltage Alarm (A.400) is likely to occur during deceleration if the load moment of inertia exceeds the allowable load moment of inertia. SERVOPACKs with a built-in regenerative resistor may generate a Regenerative Overload Alarm (A.320). Refer to *Built-In Regenerative Resistor* (page 472) for the regenerative power (W) that can be processed by the SERVOPACKs.
Install an External Regenerative Resistor when the built-in regenerative resistor cannot process all of the regenerative power.

◆ SERVOPACKs without Built-in Regenerative Resistors

The following graph shows the allowable load moment of inertia scaling factor of the motor speed (reference values for deceleration operation at or above the rated torque). Application is possible without an external regenerative resistor within the allowable value. However, an External Regenerative Resistor is required in the shaded areas of the graphs.

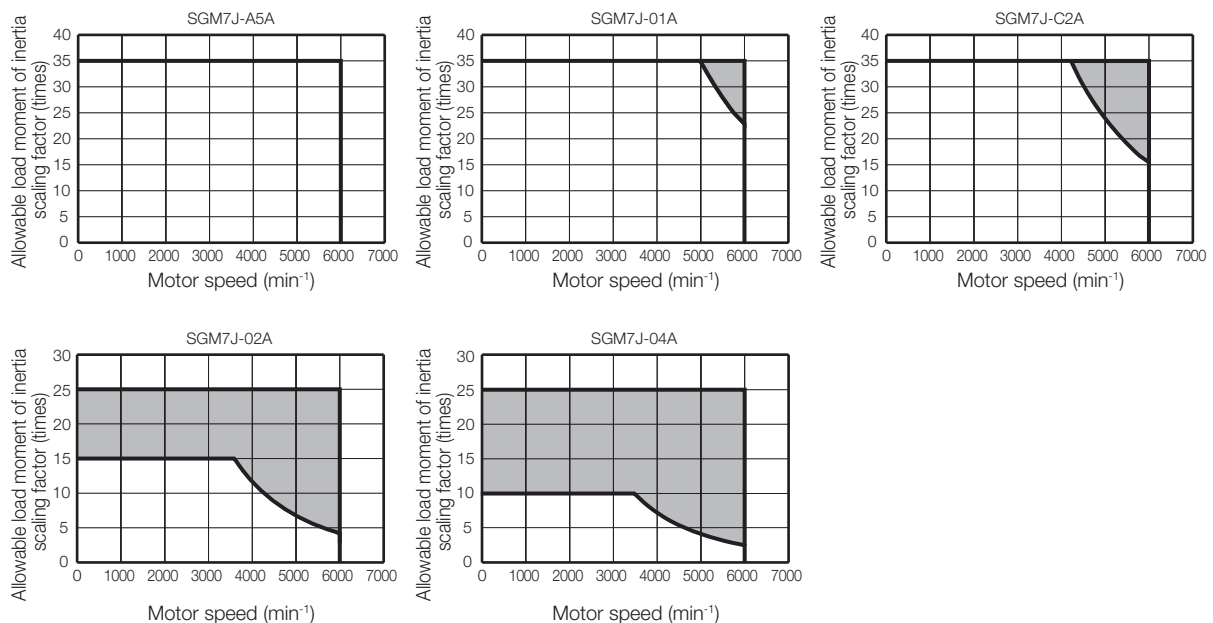

Note: Applicable SERVOPACK models: SGD7S-R70A, -R90A, -1R6A, -2R8A, -R70F, -R90F, -2R1F, and -2R8F

◆ When an External Regenerative Resistor Is Required

Install the External Regenerative Resistor. Refer to the following section for the recommended products.

External Regenerative Resistors (page 472)

Derating Rates

◆ Servomotor Heat Dissipation Conditions

The Servomotor ratings are the continuous allowable values at a surrounding air temperature of 40°C when a heat sink is installed on the Servomotor. If the Servomotor is mounted on a small device component, the Servomotor temperature may rise considerably because the surface for heat dissipation becomes smaller. Refer to the following graphs for the relation between the heat sink size and derating rate.

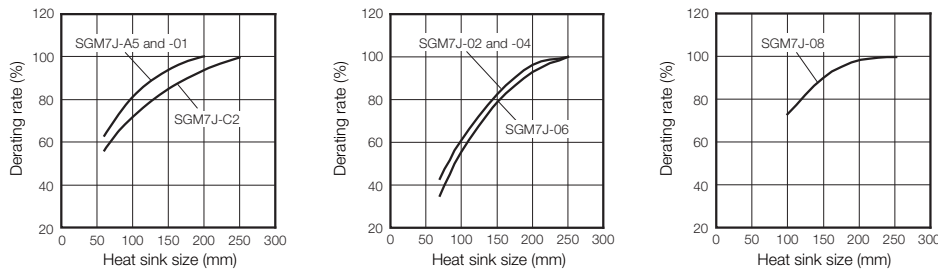

The actual temperature rise depends on how the heat sink (i.e., the Servomotor mounting section) is attached to the installation surface, what material is used for the Servomotor mounting section, and the motor speed. Always check the Servomotor temperature with the actual equipment.

◆ Applications Where the Surrounding Air Temperature Exceeds 40°C

The Servomotor ratings are the continuous allowable values at a surrounding air temperature of 40°C. If you use a Servomotor at a surrounding air temperature that exceeds 40°C (60°C max.), apply a suitable derating rate from the following graphs.

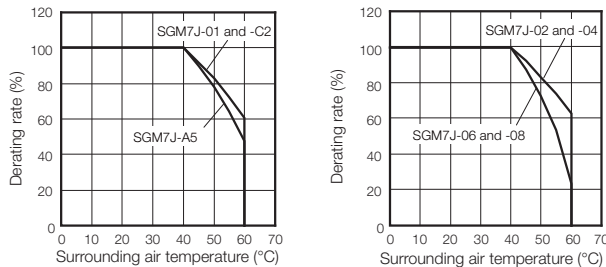

◆ Applications Where the Altitude Exceeds 1,000 m

The Servomotor ratings are the continuous allowable values at an altitude of 1,000 m or less. If you use a Servomotor at an altitude that exceeds 1,000 m (2,000 m max.), the heat dissipation effect of the air is reduced. Apply the appropriate derating rate from the following graphs.

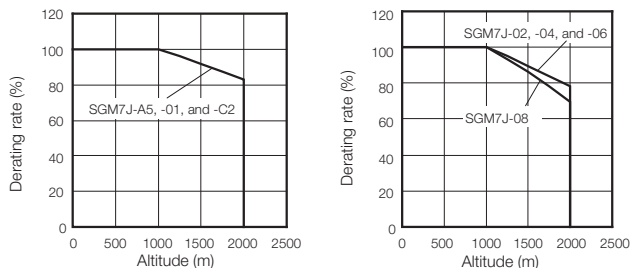

Information

When using Servomotors with derating, change the detection timing of overload warning and overload alarm based on the overload detection level of the motor given in *Servomotor Overload Protection Characteristics* (page 20).

Note: 1. Use the combination of the SERVOPACK and Servomotor so that the derating conditions are satisfied for both the SERVOPACK and Servomotor.

2. The derating rates are applicable only when the average motor speed is less than or equal to the rated motor speed. If the average motor speed exceeds the rated motor speed, consult with your Yaskawa representative.

External Dimensions

Servomotors without Gears

◆ SGM7J-A5, -01, and -C2

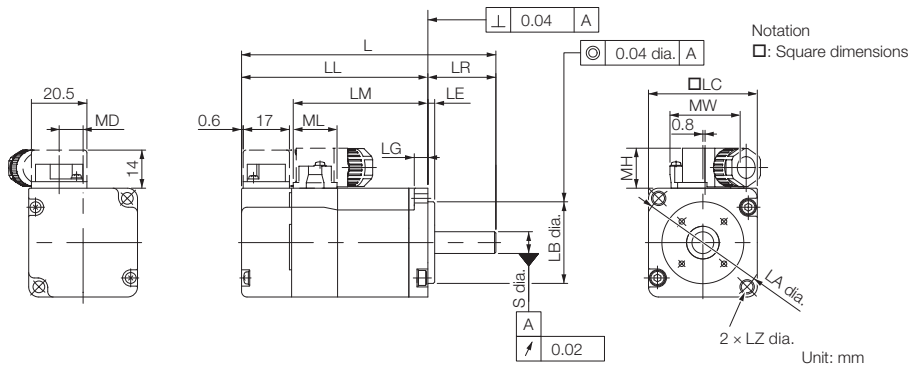

Model SGM7J-	L*	LL*	LM	Flange Dimensions							S	MD	MW	MH	ML	Approx. Mass [kg]
				LR	LE	LG	LC	LA	LB	LZ						
A5A□A2□	81.5 (122)	56.5 (97)	37.9	25	2.5	5	40	46	30 ⁰ _{-0.021}	4.3	8 ⁰ _{-0.009}	8.8	25.8	14.7	16.1	0.3 (0.6)
01A□A2□	93.5 (134)	68.5 (109)	49.9	25	2.5	5	40	46	30 ⁰ _{-0.021}	4.3	8 ⁰ _{-0.009}	8.8	25.8	14.7	16.1	0.4 (0.7)
C2A□A2□	105.5 (153.5)	80.5 (128.5)	61.9	25	2.5	5	40	46	30 ⁰ _{-0.021}	4.3	8 ⁰ _{-0.009}	8.8	25.8	14.7	16.1	0.5 (0.8)

* For models that have a batteryless absolute encoder, L and LL are 8 mm greater than the given value. Refer to the following section for the values for individual models.

■ *Dimensions of Servomotors with Batteryless Absolute Encoders* (page 32)

Note: 1. The values in parentheses are for Servomotors with Holding Brakes.

2. The values for a straight, without key specification are given. Refer to the information given below for other shaft end specifications and option specifications.

■ Shaft End Specifications

- Straight with Key and Tap

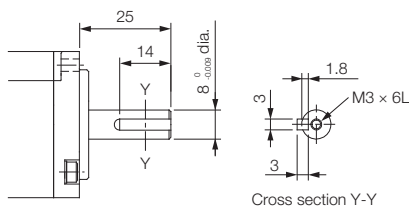

- With Two Flat Seats

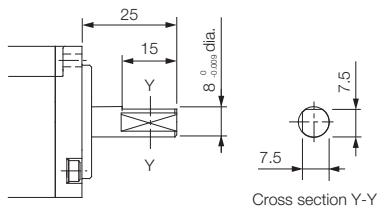

■ Specifications of Options

- Oil Seal

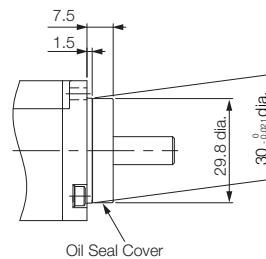

■ Connector Mounting Dimensions

- Cable Installed on Load Side

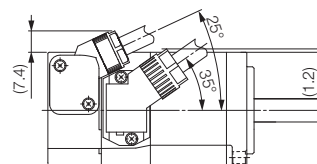

- Cable Installed on Non-load Side

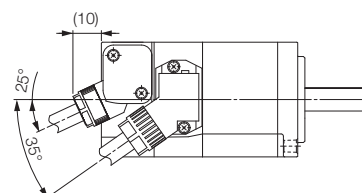

◆ SGM7J-02, -04, and -06

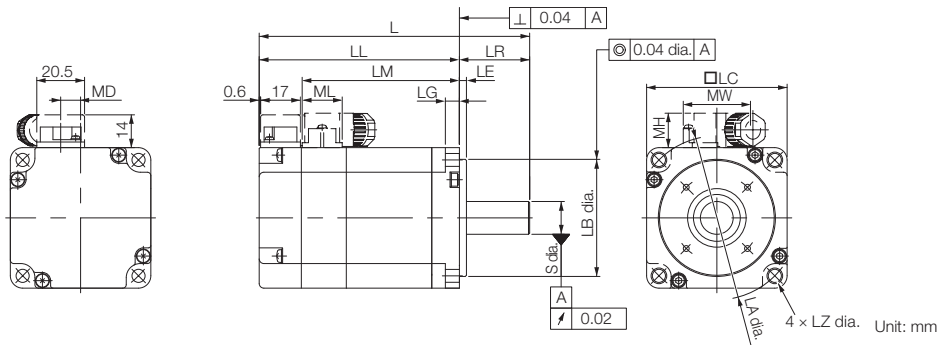

Model SGM7J-	L*	LL*	LM	Flange Dimensions							S	MD	MW	MH	ML	Approx. Mass [kg]
				LR	LE	LG	LC	LA	LB	LZ						
02A□A2□	99.5 (140)	69.5 (110)	51.2	30	3	6	60	70	50 ⁰ _{-0.025}	5.5	14 ⁰ _{-0.011}	8.5	28.7	14.7	17.1	0.8 (1.4)
04A□A2□	115.5 (156)	85.5 (126)	67.2	30	3	6	60	70	50 ⁰ _{-0.025}	5.5	14 ⁰ _{-0.011}	8.5	28.7	14.7	17.1	1.1 (1.7)
06A□A2□	137.5 (191.5)	107.5 (161.5)	89.2	30	3	6	60	70	50 ⁰ _{-0.025}	5.5	14 ⁰ _{-0.011}	8.5	28.7	14.7	17.1	1.6 (2.2)

* For models that have a batteryless absolute encoder, L and LL are 8 mm greater than the given value. Refer to the following section for the values for individual models.

📖 *Dimensions of Servomotors with Batteryless Absolute Encoders (page 32)*

Note: 1. The values in parentheses are for Servomotors with Holding Brakes.

2. The values for a straight, without key specification are given. Refer to the information given below for other shaft end specifications and option specifications.

■ Shaft End Specifications

- Straight with Key and Tap

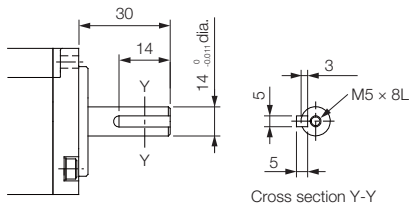

- With Two Flat Seats

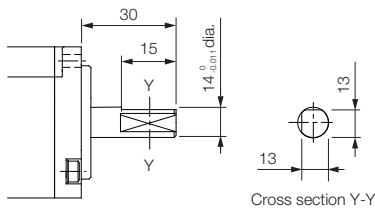

■ Specifications of Options

- Oil Seal

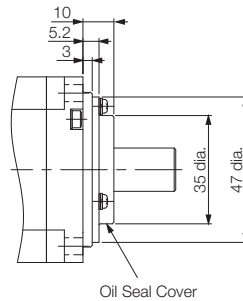

■ Connector Mounting Dimensions

- Cable Installed on Load Side

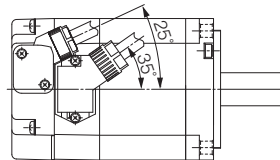

- Cable Installed on Non-load Side

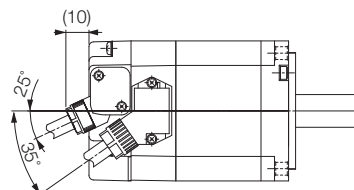

◆ SGM7J-08

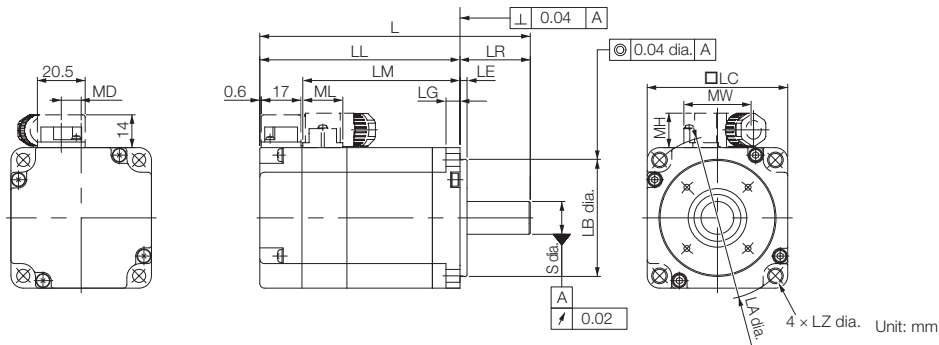

Model SGM7J-	L*	LL*	LM	Flange Dimensions							S	MD	MW	MH	ML	Approx. Mass* [kg]
				LR	LE	LG	LC	LA	LB	LZ						
08A□A2□	137 (184)	97 (144)	78.5	40	3	8	80	90	70 ⁰ _{-0.030}	7	19 ⁰ _{-0.013}	13.6	38	14.7	19.3	2.2 (2.8)

* For models that have a batteryless absolute encoder, L and LL are 8 mm greater and the approximate mass is 0.1 kg greater than the given value. Refer to the following section for the values for individual models.

🔧 **Dimensions of Servomotors with Batteryless Absolute Encoders (page 32)**

Note: 1. The values in parentheses are for Servomotors with Holding Brakes.

2. The values for a straight, without key specification are given. Refer to the information given below for other shaft end specifications and option specifications.

■ Shaft End Specifications

- Straight with Key and Tap

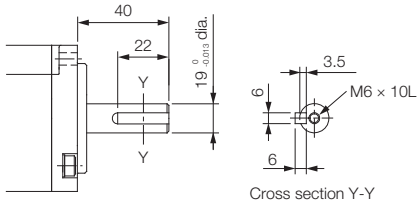

- With Two Flat Seats

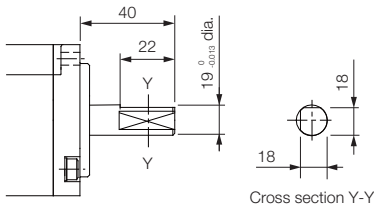

■ Specifications of Options

- Oil Seal

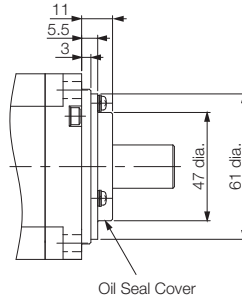

■ Connector Mounting Dimensions

- Cable Installed on Load Side

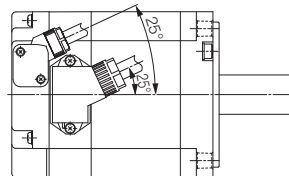

- Cable Installed on Non-load Side

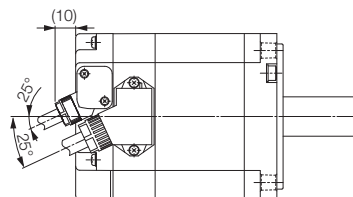

Servomotors with Gears

◆ SGM7J-A5, -01, and -C2

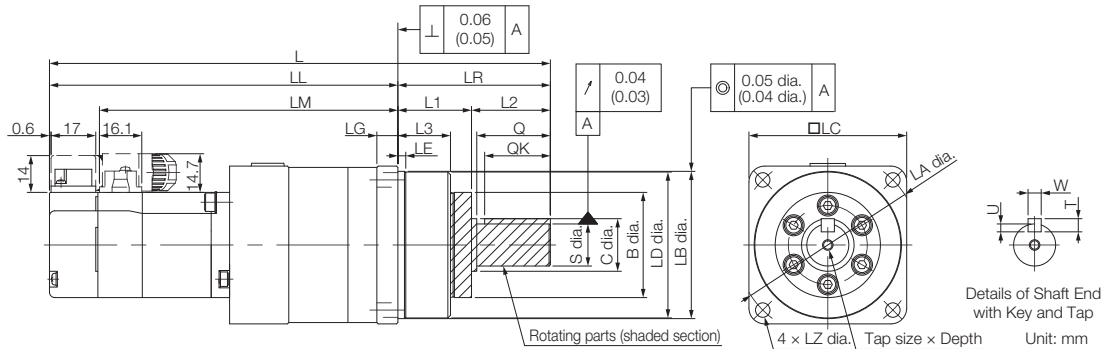

Model SGM7J-	Gear Ratio	L*	LL*	LM	Flange Dimensions								
					LR	LE	LG	B	LD	LB	LC	LA	LZ
A5A□AH1□□	1/5	138	96	77.4									
A5A□AH2□□	1/9	(178.5)	(136.5)		42	2.2	5	29	39.5	40 ⁰ _{-0.025}	40	46	3.4
A5A□AHC□□	1/21	147	105	86.4									
A5A□AH7□□	1/33	178.5	120.5	101.9	58	2.5	8	40	55.5	56 ⁰ _{-0.030}	60	70	5.5
01A□AH1□□	1/5	150	108	89.4	42	2.2	5	29	39.5	40 ⁰ _{-0.025}	40	46	3.4
01A□AHB□□	1/11	190.5	132.5	113.9	58	2.5	8	40	55.5	56 ⁰ _{-0.030}	60	70	5.5
01A□AHC□□	1/21	(231)	(173)										
01A□AH7□□	1/33	215	135	116.4	80	7.5	10	59	84	85 ⁰ _{-0.035}	90	105	9
C2A□AH1□□	1/5	162	120	101.4	42	2.2	5	29	39.5	40 ⁰ _{-0.025}	40	46	3.4
C2A□AHB□□	1/11	202.5	144.5	125.9	58	2.5	8	40	55.5	56 ⁰ _{-0.030}	60	70	5.5
C2A□AHC□□	1/21	227	147	128.4	80	7.5	10	59	84	85 ⁰ _{-0.035}	90	105	9
C2A□AH7□□	1/33	(275)	(195)										

Model SGM7J-	Flange Dimensions			Q	C	S	Tap Size × Depth	Key Dimensions				Approx. Mass [kg]
	L1	L2	L3					QK	U	W	T	
A5A□AH1□□	22	20	14.6	-	-	10 ⁰ _{-0.015}	M3 × 6L	15	2.5	4	4	0.6 (0.9)
A5A□AH2□□												0.7 (1.0)
A5A□AHC□□												
A5A□AH7□□	28	30	20	28	20	16 ⁰ _{-0.018}	M4 × 8L	25	3	5	5	1.3 (1.6)
01A□AH1□□	22	20	14.6	-	-	10 ⁰ _{-0.015}	M3 × 6L	15	2.5	4	4	0.7 (1.0)
01A□AHB□□	28	30	20	28	20	16 ⁰ _{-0.018}	M4 × 8L	25	3	5	5	1.4 (1.7)
01A□AHC□□												
01A□AH7□□	36	44	26	42	32	25 ⁰ _{-0.021}	M6 × 12L	36	4	8	7	2.8 (3.1)
C2A□AH1□□	22	20	14.6	-	-	10 ⁰ _{-0.015}	M3 × 6L	15	2.5	4	4	0.8 (1.1)
C2A□AHB□□	28	30	20	28	20	16 ⁰ _{-0.018}	M4 × 8L	25	3	5	5	1.5 (1.8)
C2A□AHC□□	36	44	26	42	32	25 ⁰ _{-0.021}	M6 × 12L	36	4	8	7	2.9 (3.2)
C2A□AH7□□												

* For models that have a batteryless absolute encoder, L and LL are 8 mm greater than the given value. Refer to the following section for the values for individual models.

🔧 Dimensions of Servomotors with Batteryless Absolute Encoders (page 32)

- Note: 1. The values in parentheses are for Servomotors with Holding Brakes.
 2. Gear dimensions are different from those of the Σ, Σ-II, and Σ-III Series.
 3. The values for the shaft end are for a straight shaft with key and tap. If a key and tap are not necessary, specify shaft end code 2 for the 8th digit.

■ Flange Output Face

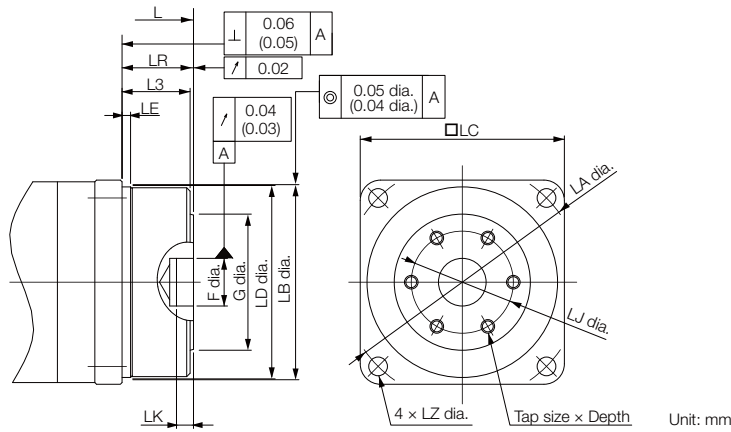

Note: The geometric tolerance in parentheses is the value for LC = 40.

Model SGM7J-	Gear Ratio	L*	LR	LJ	F	G	LK	No. of Taps × Tap Size × Depth	Approx. Mass [kg]
A5A□AH10□	1/5	111	15	18	5 ^{+0.012} ₀	24	3	3 × M4 × 6L	0.6 (0.9)
A5A□AH20□	1/9	(151.5)							
A5A□AHC0□	1/21	120 (160.5)							
A5A□AH70□	1/33	141.5 (182)	21	30	14 ^{+0.018} ₀	40	5	6 × M4 × 7L	1.2 (1.5)
01A□AH10□	1/5	123 (163.5)	15	18	5 ^{+0.012} ₀	24	5	3 × M4 × 6L	0.7 (1.0)
01A□AHB0□	1/11	153.5 (194)	21	30	14 ^{+0.018} ₀	40			
01A□AHC0□	1/21							3 × M4 × 7L	1.3 (1.6)
01A□AH70□	1/33	162 (202.5)	27	45	24 ^{+0.021} ₀	59		6 × M6 × 10L	2.4 (2.7)
C2A□AH10□	1/5	135 (183)	15	18	5 ^{+0.012} ₀	24	3	3 × M4 × 6L	0.8 (1.1)
C2A□AHB0□	1/11	165.5 (213.5)	21	30	14 ^{+0.018} ₀	40	5	6 × M4 × 7L	1.4 (1.7)
C2A□AHC0□	1/21	174 (222)	27	45	24 ^{+0.021} ₀	59	5	6 × M6 × 10L	2.5 (2.8)
C2A□AH70□	1/33								

* For models that have a batteryless absolute encoder, L is 8 mm greater than the given value. Refer to the following section for the values for individual models.

Dimensions of Servomotors with Batteryless Absolute Encoders (page 32)

Note: 1. The values in parentheses are for Servomotors with Holding Brakes.

2. Dimensions not found in the above table are the same as those in the table on the previous page.

Important

For a Servomotor with a flange output that has square gear flange dimensions (□LC) of 40 mm, we recommend that you design the Servomotor with the dimensions shown in the following figure in order to secure a gap between the gear oil seal and the connecting parts on the load side.

◆ SGM7J-02, -04, and -06

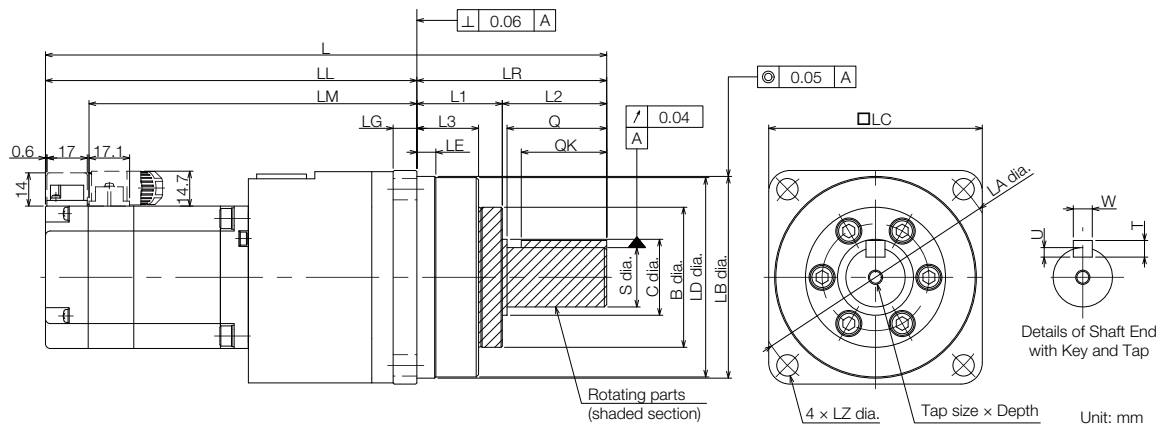

Model SGM7J-	Gear Ratio	L*	LL*	LM	Flange Dimensions								
					LR	LE	LG	B	LD	LB	LC	LA	LZ
02A□AH1□□	1/5	191.5	133.5	115.2	58	2.5	8	40	55.5	56 ⁰ _{-0.030}	60	70	5.5
02A□AHB□□	1/11	(232)	(174)										
02A□AHC□□	1/21	220.5	140.5	122.2	80	7.5	10	59	84	85 ⁰ _{-0.035}	90	105	9
02A□AH7□□	1/33	(261)	(181)										
04A□AH1□□	1/5	207.5	149.5	131.2	58	2.5	8	40	55.5	56 ⁰ _{-0.030}	60	70	5.5
04A□AHB□□	1/11	236.5	156.5										
04A□AHC□□	1/21	(277)	(197)	138.2	80	7.5	10	59	84	85 ⁰ _{-0.035}	90	105	9
04A□AH7□□	1/33	322.5	189.5										
		(363)	(230)	171.2	133	12.5	13	84	114	115 ⁰ _{-0.035}	120	135	11
06A□AH1□□	1/5	258.5	178.5										
06A□AHB□□	1/11	(312.5)	(232.5)	160.2	80	7.5	10	59	84	85 ⁰ _{-0.035}	90	105	9
06A□AHC□□	1/21	344.5	211.5										
06A□AH7□□	1/33	(398.5)	(265.5)	193.2	133	12.5	13	84	114	115 ⁰ _{-0.035}	120	135	11

Model SGM7J-	Flange Dimensions			Q	C	S	Tap Size × Depth	Key Dimensions				Approx. Mass [kg]
	L1	L2	L3					QK	U	W	T	
02A□AH1□□	28	30	20	28	20	16 ⁰ _{-0.018}	M4 × 8L	25	3	5	5	1.8 (2.4)
02A□AHB□□												1.9 (2.5)
02A□AHC□□	36	44	26	42	32	25 ⁰ _{-0.021}	M6 × 12L	36	4	8	7	3.7 (4.3)
02A□AH7□□												
04A□AH1□□	28	30	20	28	20	16 ⁰ _{-0.018}	M4 × 8L	25	3	5	5	2.1 (2.7)
04A□AHB□□												
04A□AHC□□	36	44	26	42	32	25 ⁰ _{-0.021}	M6 × 12L	36	4	8	7	4.0 (4.6)
04A□AH7□□												
	48	85	33	82	44	40 ⁰ _{-0.025}	M10 × 20L	70	5	12	8	8.6 (9.2)
06A□AH1□□												
06A□AHB□□	36	44	26	42	32	25 ⁰ _{-0.021}	M6 × 12L	36	4	8	7	4.3 (4.9)
06A□AHC□□												
06A□AH7□□	48	85	33	82	44	40 ⁰ _{-0.025}	M10 × 20L	70	5	12	8	4.5 (5.1)
												9.1 (9.7)

* For models that have a batteryless absolute encoder, L and LL are 8 mm greater than the given value. Refer to the following section for the values for individual models.

🔍 **Dimensions of Servomotors with Batteryless Absolute Encoders (page 32)**

Note: 1. The values in parentheses are for Servomotors with Holding Brakes.

2. Gear dimensions are different from those of the Σ, Σ-II, and Σ-III Series.

3. The values for the shaft end are for a straight shaft with key and tap. If a key and tap are not necessary, specify shaft end code 2 for the 8th digit.

■ Flange Output Face

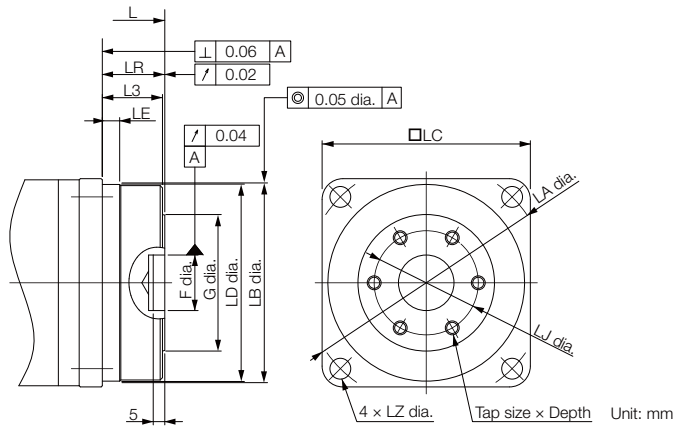

Model SGM7J-	Gear Ratio	L*	LR	LJ	F	G	No. of Taps × Tap Size × Depth	Approx. Mass [kg]
02A□AH10□	1/5	154.5 (195)	21	30	14 ^{+0.018} ₀	40	6 × M4 × 7L	1.7 (2.3)
02A□AHB0□	1/11							1.8 (2.4)
02A□AHC0□	1/21	167.5 (208)	27	45	24 ^{+0.021} ₀	59	6 × M6 × 10L	3.3 (3.9)
02A□AH70□	1/33							
04A□AH10□	1/5	170.5 (211)	21	30	14 ^{+0.018} ₀	40	6 × M4 × 7L	2.0 (2.6)
04A□AHB0□	1/11	183.5 (224)	27	45	24 ^{+0.021} ₀	59	6 × M6 × 10L	3.6 (4.2)
04A□AHC0□	1/21							
04A□AH70□	1/33	224.5 (265)	35	60	32 ^{+0.025} ₀	84	6 × M8 × 12L	7.2 (7.8)
06A□AH10□	1/5	205.5 (259.5)	27	45	24 ^{+0.021} ₀	59	6 × M6 × 10L	3.9 (4.5)
06A□AHB0□	1/11							4.1 (4.7)
06A□AHC0□	1/21	246.5 (300.5)	35	60	32 ^{+0.025} ₀	84	6 × M8 × 12L	7.7 (8.3)
06A□AH70□	1/33							

* For models that have a batteryless absolute encoder, L is 8 mm greater than the given value. Refer to the following section for the values for individual models.

Dimensions of Servomotors with Batteryless Absolute Encoders (page 32)

Note: 1. The values in parentheses are for Servomotors with Holding Brakes.

2. Dimensions not found in the above table are the same as those in the table on the previous page.

◆ SGM7J-08

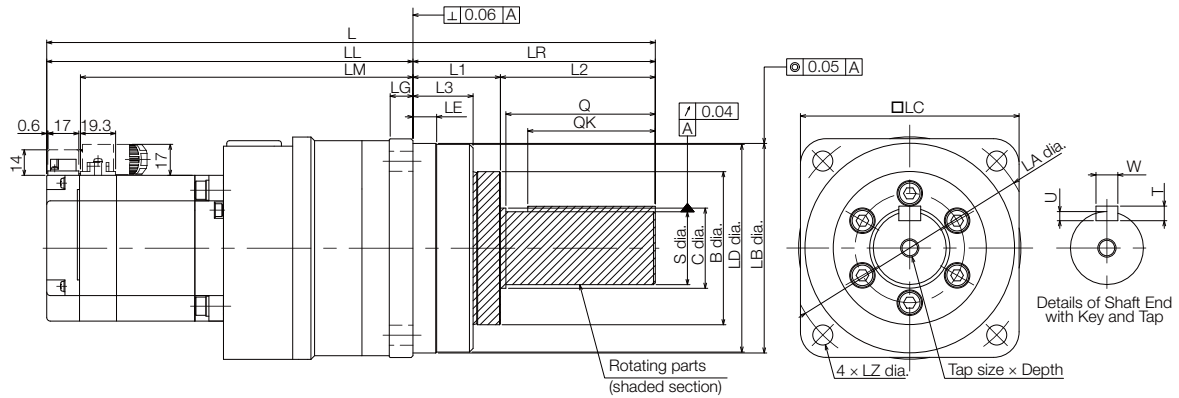

Unit: mm

Model SGM7J-	Gear Ratio	L*	LL*	LM	Flange Dimensions								
					LR	LE	LG	B	LD	LB	LC	LA	LZ
08A□AH1□□	1/5	255	175	156.5	80	7.5	10	59	84	85 ⁰ _{-0.035}	90	105	9
08A□AHB□□	1/11	(302)	(222)										
08A□AHC□□	1/21	334	201	182.5	133	12.5	13	84	114	115 ⁰ _{-0.035}	120	135	11
08A□AH7□□	1/33	(381)	(248)										

Model SGM7J-	Flange Dimensions			Q	C	S	Tap Size × Depth	Key Dimensions				Approx. Mass* [kg]
	L1	L2	L3					QK	U	W	T	
08A□AH1□□	36	44	26	42	32	25 ⁰ _{-0.021}	M6 × 12L	36	4	8	7	5.1 (5.7)
08A□AHB□□												5.3 (5.9)
08A□AHC□□	48	85	33	82	44	40 ⁰ _{-0.025}	M10 × 20L	70	5	12	8	10 (10.6)
08A□AH7□□												

* For models that have a batteryless absolute encoder, L and LL are 8 mm greater and the approximate mass is 0.1 kg greater than the given value. Refer to the following section for the values for individual models.

🔧 Dimensions of Servomotors with Batteryless Absolute Encoders (page 32)

Note: 1. The values in parentheses are for Servomotors with Holding Brakes.

2. Gear dimensions are different from those of the Σ, Σ-II, and Σ-III Series.

3. The values for the shaft end are for a straight shaft with key and tap. If a key and tap are not necessary, specify shaft end code 2 for the 8th digit.

■ Flange Output Face

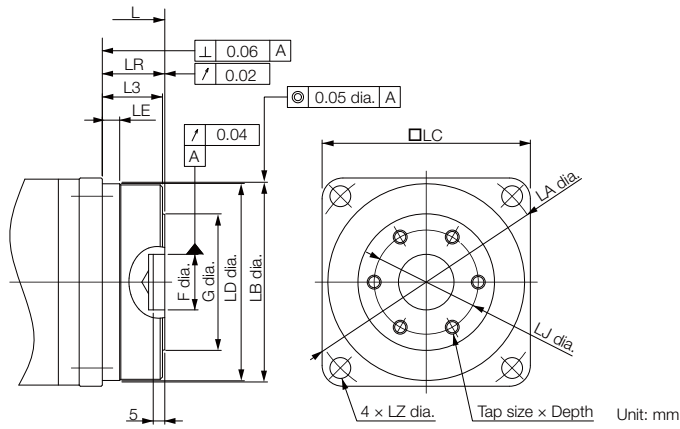

Model SGM7J-	Gear Ratio	L*	LR	LJ	F	G	No. of Taps × Tap Size × Depth	Approx. Mass* [kg]
08A□AH101	1/5	202 (249)	27	45	24 ^{+0.021} ₀	59	6 × M6 × 10L	4.7 (5.3)
08A□AHB01	1/11							4.9 (5.5)
08A□AHC01	1/21	236 (283)	35	60	32 ^{+0.025} ₀	84	6 × M8 × 12L	8.6 (9.2)
08A□AH701	1/33							

* For models that have a batteryless absolute encoder, L is 8 mm greater and the approximate mass is 0.1 kg greater than the given value. Refer to the following section for the values for individual models.

 *Dimensions of Servomotors with Batteryless Absolute Encoders (page 32)*

Note: 1. The values in parentheses are for Servomotors with Holding Brakes.

2. Dimensions not found in the above table are the same as those in the table on the previous page.

Dimensions of Servomotors with Batteryless Absolute Encoders

◆ Servomotors without Gears

Model SGM7J-	L	LL	Approx. Mass [kg]
A5A6A2□	89.5 (130)	64.5 (105)	0.3 (0.6)
01A6A2□	101.5 (142)	76.5 (117)	0.4 (0.7)
C2A6A2□	113.5 (161.5)	88.5 (136.5)	0.5 (0.8)
02A6A2□	107.5 (148)	77.5 (118)	0.8 (1.4)
04A6A2□	123.5 (164)	93.5 (134)	1.1 (1.7)
06A6A2□	145.5 (198.5)	115.5 (169.5)	1.6 (2.2)
08A6A2□	145 (192)	105 (152)	2.3 (2.9)

Note: The values in parentheses are for Servomotors with Holding Brakes.

◆ Servomotors with Gears

• Shaft End Specification: Straight

Model SGM7J-	L	LL	Approx. Mass [kg]
A5A6AH1□□	146 (186.5)	104 (144.5)	0.6 (0.9)
A5A6AH2□□			
A5A6AHC□□	155 (195.5)	113 (153.5)	0.7 (1.7)
A5A6AH7□□	186.5 (227)	128.5 (169)	1.3 (1.6)
01A6AH1□□	158 (198.5)	116 (156.5)	0.7 (1.0)
01A6AHB□□	198.5 (239)	140.5 (181)	1.4 (1.7)
01A6AHC□□			
01A6AH7□□	223 (263.5)	143 (183.5)	2.8 (3.1)
C2A6AH1□□	170 (218)	128 (176)	0.8 (1.1)
C2A6AHB□□	210.5 (258.5)	152.5 (200.5)	1.5 (1.8)
C2A6AHC□□	235 (283)	155 (203)	2.9 (3.2)
C2A6AH7□□			
02A6AH1□□	191.5 (232)	141.5 (182.5)	1.8 (2.4)
02A6AHB□□			1.9 (2.5)
02A6AHC□□	228.5 (269)	148.5 (189)	3.7 (4.3)
02A6AH7□□			
04A6AH1□□	207.5 (248)	149.5 (198)	2.1 (2.7)
04A6AHB□□	236.5 (285)	184.5 (205)	4.0 (4.6)
04A6AHC□□			
04A6AH7□□	330.5 (371)	197.5 (238)	8.6 (9.2)
06A6AH1□□	266.5 (320.5)	186.5 (240.5)	4.3 (4.9)
06A6AHB□□			4.5 (5.1)
06A6AHC□□	352.5 (406.5)	219.5 (273.5)	9.1 (9.7)
06A6AH7□□			
08A6AH1□□	263 (310)	183 (230)	5.2 (5.8)
08A6AHB□□			5.4 (6.0)
08A6AHC□□	342 (389)	209 (256)	10.1 (10.7)
08A6AH7□□			

• Shaft End Specification: Flange Output

Model SGM7J-	L	Approx. Mass [kg]
A5A6AH10□	119 (159.5)	0.6 (0.9)
A5A6AH20□		
A5A6AHC0□	128 (168.5)	
A5A6AH70□	149.5 (190)	1.2 (1.5)
01A6AH10□	131 (171.5)	0.7 (1.0)
01A6AHB0□	161.5 (202)	1.3 (1.6)
01A6AHC0□		
01A6AH70□	170 (210.5)	2.4 (2.7)
C2A6AH10□	143 (191)	0.8 (1.1)
C2A6AHB0□	173.5 (221.5)	1.4 (1.7)
C2A6AHC0□	210.5 (258.5)	2.5 (2.8)
C2A6AH70□		
02A6AH10□	162.5 (203)	1.7 (2.3)
02A6AHB0□		1.8 (2.4)
02A6AHC0□	175.5 (216)	3.3 (3.9)
02A6AH70□		
04A6AH10□	178.5 (219)	2.0 (2.6)
04A6AHB0□	191.5 (232)	3.6 (4.2)
04A6AHC0□		
04A6AH70□	232.5 (273)	7.2 (7.8)
06A6AH10□	213.5 (267.5)	3.9 (4.5)
06A6AHB0□		4.1 (4.7)
06A6AHC0□	254.5 (308.5)	7.7 (8.3)
06A6AH70□		
08A6AH10□	210 (257)	4.8 (5.4)
08A6AHB0□		5.0 (5.6)
08A6AHC0□	244 (291)	8.7 (9.3)
08A6AH70□		

Note: The values in parentheses are for Servomotors with Holding Brakes.

Selecting Cables

◆ Cable Configurations

The cables shown below are required to connect a Servomotor to a SERVOPACK.

Encoder Cable of 20 m or Less

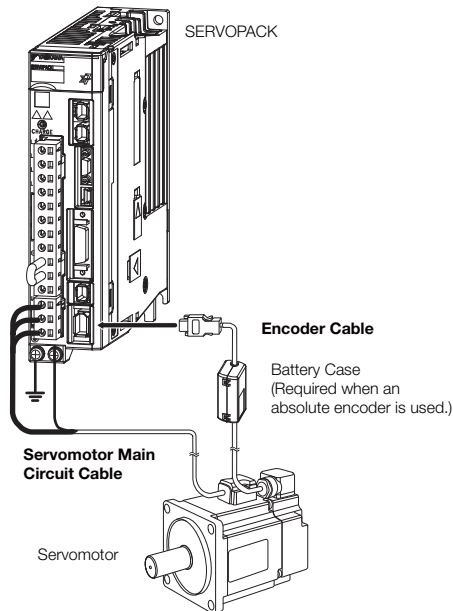

Encoder Cable of 30 m to 50 m (Relay Cable)

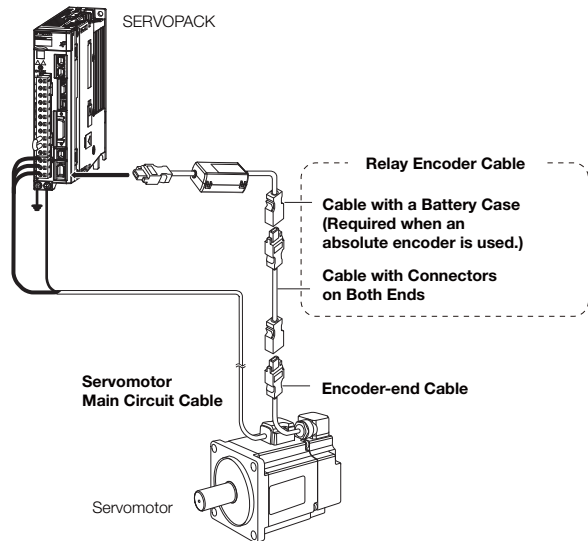

Note: 1. If the Encoder Cable length exceeds 20 m, be sure to use a Relay Encoder Cable.

2. If you use a Servomotor Main Circuit Cable that exceeds 20 m, the intermittent duty zone in the torque-speed characteristics will become smaller because the voltage drop increases.

3. Refer to the following manual for the following information.

- Cable dimensional drawings and cable connection specifications
- Order numbers and specifications of individual connectors for cables
- Order numbers and specifications for wiring materials

☞ *Σ-7-Series AC Servo Drive Peripheral Device Selection Manual (Manual No.: S1EP S80001 32)*



Important

There are different order numbers for the Servomotor Main Circuit Cables and Encoder Cables depending on the cable installation direction. Confirm the order numbers before you order.

Cable Installed toward Load

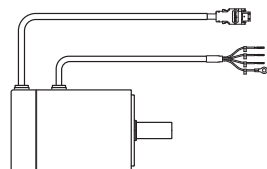

Cable Installed away from Load

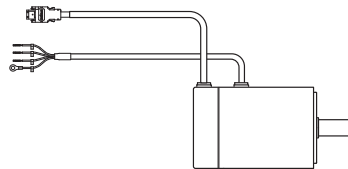

◆ Servomotor Main Circuit Cables

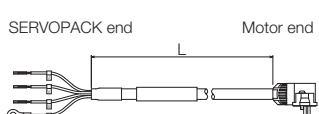
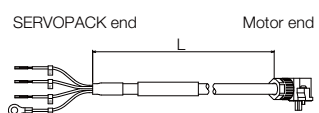
Servomotor Model	Name	Length (L)	Order Number		Appearance
			Standard Cable	Flexible Cable*	
SGM7J-A5 to -C2 50 W to 150 W		3 m	JZSP-C7M10F-03-E	JZSP-C7M12F-03-E	
		5 m	JZSP-C7M10F-05-E	JZSP-C7M12F-05-E	
		10 m	JZSP-C7M10F-10-E	JZSP-C7M12F-10-E	
		15 m	JZSP-C7M10F-15-E	JZSP-C7M12F-15-E	
		20 m	JZSP-C7M10F-20-E	JZSP-C7M12F-20-E	
		30 m	JZSP-C7M10F-30-E	JZSP-C7M12F-30-E	
		40 m	JZSP-C7M10F-40-E	JZSP-C7M12F-40-E	
		50 m	JZSP-C7M10F-50-E	JZSP-C7M12F-50-E	
SGM7J-02 to -06 200 W to 600 W	For Servo- motors with- out Holding Brakes	3 m	JZSP-C7M20F-03-E	JZSP-C7M22F-03-E	
		5 m	JZSP-C7M20F-05-E	JZSP-C7M22F-05-E	
		10 m	JZSP-C7M20F-10-E	JZSP-C7M22F-10-E	
		15 m	JZSP-C7M20F-15-E	JZSP-C7M22F-15-E	
		20 m	JZSP-C7M20F-20-E	JZSP-C7M22F-20-E	
		30 m	JZSP-C7M20F-30-E	JZSP-C7M22F-30-E	
		40 m	JZSP-C7M20F-40-E	JZSP-C7M22F-40-E	
		50 m	JZSP-C7M20F-50-E	JZSP-C7M22F-50-E	
SGM7J-08 750 W, 1.0 kW		3 m	JZSP-C7M30F-03-E	JZSP-C7M32F-03-E	
		5 m	JZSP-C7M30F-05-E	JZSP-C7M32F-05-E	
		10 m	JZSP-C7M30F-10-E	JZSP-C7M32F-10-E	
		15 m	JZSP-C7M30F-15-E	JZSP-C7M32F-15-E	
		20 m	JZSP-C7M30F-20-E	JZSP-C7M32F-20-E	
		30 m	JZSP-C7M30F-30-E	JZSP-C7M32F-30-E	
		40 m	JZSP-C7M30F-40-E	JZSP-C7M32F-40-E	
		50 m	JZSP-C7M30F-50-E	JZSP-C7M32F-50-E	
SGM7J-A5 to -C2 50 W to 150 W		3 m	JZSP-C7M10G-03-E	JZSP-C7M12G-03-E	
		5 m	JZSP-C7M10G-05-E	JZSP-C7M12G-05-E	
		10 m	JZSP-C7M10G-10-E	JZSP-C7M12G-10-E	
		15 m	JZSP-C7M10G-15-E	JZSP-C7M12G-15-E	
		20 m	JZSP-C7M10G-20-E	JZSP-C7M12G-20-E	
		30 m	JZSP-C7M10G-30-E	JZSP-C7M12G-30-E	
		40 m	JZSP-C7M10G-40-E	JZSP-C7M12G-40-E	
		50 m	JZSP-C7M10G-50-E	JZSP-C7M12G-50-E	
SGM7J-02 to -06 200 W to 600 W	For Servo- motors with- out Holding Brakes	3 m	JZSP-C7M20G-03-E	JZSP-C7M22G-03-E	
		5 m	JZSP-C7M20G-05-E	JZSP-C7M22G-05-E	
		10 m	JZSP-C7M20G-10-E	JZSP-C7M22G-10-E	
		15 m	JZSP-C7M20G-15-E	JZSP-C7M22G-15-E	
		20 m	JZSP-C7M20G-20-E	JZSP-C7M22G-20-E	
		30 m	JZSP-C7M20G-30-E	JZSP-C7M22G-30-E	
		40 m	JZSP-C7M20G-40-E	JZSP-C7M22G-40-E	
		50 m	JZSP-C7M20G-50-E	JZSP-C7M22G-50-E	
SGM7J-08 750 W, 1.0 kW		3 m	JZSP-C7M30G-03-E	JZSP-C7M32G-03-E	
		5 m	JZSP-C7M30G-05-E	JZSP-C7M32G-05-E	
		10 m	JZSP-C7M30G-10-E	JZSP-C7M32G-10-E	
		15 m	JZSP-C7M30G-15-E	JZSP-C7M32G-15-E	
		20 m	JZSP-C7M30G-20-E	JZSP-C7M32G-20-E	
		30 m	JZSP-C7M30G-30-E	JZSP-C7M32G-30-E	
		40 m	JZSP-C7M30G-40-E	JZSP-C7M32G-40-E	
		50 m	JZSP-C7M30G-50-E	JZSP-C7M32G-50-E	

* Use Flexible Cables for moving parts of machines, such as robots. The recommended bending radius (R) is 90 mm or larger.

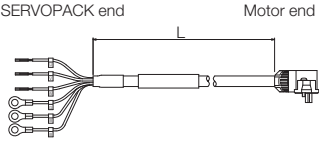
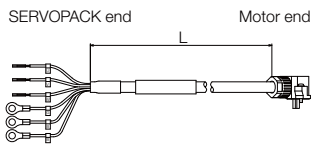
Servomotor Model	Name	Length (L)	Order Number		Appearance
			Standard Cable	Flexible Cable*	
SGM7J-A5 to -C2 50 W to 150 W		3 m	JZSP-C7M13F-03-E	JZSP-C7M14F-03-E	
		5 m	JZSP-C7M13F-05-E	JZSP-C7M14F-05-E	
		10 m	JZSP-C7M13F-10-E	JZSP-C7M14F-10-E	
		15 m	JZSP-C7M13F-15-E	JZSP-C7M14F-15-E	
		20 m	JZSP-C7M13F-20-E	JZSP-C7M14F-20-E	
		30 m	JZSP-C7M13F-30-E	JZSP-C7M14F-30-E	
		40 m	JZSP-C7M13F-40-E	JZSP-C7M14F-40-E	
		50 m	JZSP-C7M13F-50-E	JZSP-C7M14F-50-E	
SGM7J-02 to -06 200 W to 600 W	For Servo- motors with Holding Brakes	3 m	JZSP-C7M23F-03-E	JZSP-C7M24F-03-E	
		5 m	JZSP-C7M23F-05-E	JZSP-C7M24F-05-E	
		10 m	JZSP-C7M23F-10-E	JZSP-C7M24F-10-E	
		15 m	JZSP-C7M23F-15-E	JZSP-C7M24F-15-E	
		20 m	JZSP-C7M23F-20-E	JZSP-C7M24F-20-E	
		30 m	JZSP-C7M23F-30-E	JZSP-C7M24F-30-E	
		40 m	JZSP-C7M23F-40-E	JZSP-C7M24F-40-E	
		50 m	JZSP-C7M23F-50-E	JZSP-C7M24F-50-E	
SGM7J-08 750 W, 1.0 kW		3 m	JZSP-C7M33F-03-E	JZSP-C7M34F-03-E	
		5 m	JZSP-C7M33F-05-E	JZSP-C7M34F-05-E	
		10 m	JZSP-C7M33F-10-E	JZSP-C7M34F-10-E	
		15 m	JZSP-C7M33F-15-E	JZSP-C7M34F-15-E	
		20 m	JZSP-C7M33F-20-E	JZSP-C7M34F-20-E	
		30 m	JZSP-C7M33F-30-E	JZSP-C7M34F-30-E	
		40 m	JZSP-C7M33F-40-E	JZSP-C7M34F-40-E	
		50 m	JZSP-C7M33F-50-E	JZSP-C7M34F-50-E	
SGM7J-A5 to -C2 50 W to 150 W		3 m	JZSP-C7M13G-03-E	JZSP-C7M14G-03-E	
		5 m	JZSP-C7M13G-05-E	JZSP-C7M14G-05-E	
		10 m	JZSP-C7M13G-10-E	JZSP-C7M14G-10-E	
		15 m	JZSP-C7M13G-15-E	JZSP-C7M14G-15-E	
		20 m	JZSP-C7M13G-20-E	JZSP-C7M14G-20-E	
		30 m	JZSP-C7M13G-30-E	JZSP-C7M14G-30-E	
		40 m	JZSP-C7M13G-40-E	JZSP-C7M14G-40-E	
		50 m	JZSP-C7M13G-50-E	JZSP-C7M14G-50-E	
SGM7J-02 to -06 200 W to 600 W	For Servo- motors with Holding Brakes	3 m	JZSP-C7M23G-03-E	JZSP-C7M24G-03-E	
		5 m	JZSP-C7M23G-05-E	JZSP-C7M24G-05-E	
		10 m	JZSP-C7M23G-10-E	JZSP-C7M24G-10-E	
		15 m	JZSP-C7M23G-15-E	JZSP-C7M24G-15-E	
		20 m	JZSP-C7M23G-20-E	JZSP-C7M24G-20-E	
		30 m	JZSP-C7M23G-30-E	JZSP-C7M24G-30-E	
		40 m	JZSP-C7M23G-40-E	JZSP-C7M24G-40-E	
		50 m	JZSP-C7M23G-50-E	JZSP-C7M24G-50-E	
SGM7J-08 750 W, 1.0 kW	Cable installed away from load	3 m	JZSP-C7M33G-03-E	JZSP-C7M34G-03-E	
		5 m	JZSP-C7M33G-05-E	JZSP-C7M34G-05-E	
		10 m	JZSP-C7M33G-10-E	JZSP-C7M34G-10-E	
		15 m	JZSP-C7M33G-15-E	JZSP-C7M34G-15-E	
		20 m	JZSP-C7M33G-20-E	JZSP-C7M34G-20-E	
		30 m	JZSP-C7M33G-30-E	JZSP-C7M34G-30-E	
		40 m	JZSP-C7M33G-40-E	JZSP-C7M34G-40-E	
		50 m	JZSP-C7M33G-50-E	JZSP-C7M34G-50-E	

* Use Flexible Cables for moving parts of machines, such as robots. The recommended bending radius (R) is 90 mm or larger.

◆ Encoder Cables of 20 m or Less

Servomotor Model	Name	Length (L)	Order Number		Appearance	
			Standard Cable	Flexible Cable* ¹		
All SGM7J models	For incremental encoder, or batteryless absolute encoder	3 m	JZSP-C7PI0D-03-E	JZSP-C7PI2D-03-E		
		5 m	JZSP-C7PI0D-05-E	JZSP-C7PI2D-05-E		
	10 m	JZSP-C7PI0D-10-E	JZSP-C7PI2D-10-E			
	Cable installed toward load	15 m	JZSP-C7PI0D-15-E	JZSP-C7PI2D-15-E		
		20 m	JZSP-C7PI0D-20-E	JZSP-C7PI2D-20-E		
	For incremental encoder, or batteryless absolute encoder	Cable installed away from load	3 m	JZSP-C7PI0E-03-E		JZSP-C7PI2E-03-E
			5 m	JZSP-C7PI0E-05-E	JZSP-C7PI2E-05-E	
			10 m	JZSP-C7PI0E-10-E	JZSP-C7PI2E-10-E	
			15 m	JZSP-C7PI0E-15-E	JZSP-C7PI2E-15-E	
			20 m	JZSP-C7PI0E-20-E	JZSP-C7PI2E-20-E	
	For absolute encoder: With Battery Case* ²	Cable installed toward load	3 m	JZSP-C7PA0D-03-E	JZSP-C7PA2D-03-E	
			5 m	JZSP-C7PA0D-05-E	JZSP-C7PA2D-05-E	
			10 m	JZSP-C7PA0D-10-E	JZSP-C7PA2D-10-E	
			15 m	JZSP-C7PA0D-15-E	JZSP-C7PA2D-15-E	
			20 m	JZSP-C7PA0D-20-E	JZSP-C7PA2D-20-E	
	For absolute encoder: With Battery Case* ²	Cable installed away from load	3 m	JZSP-C7PA0E-03-E	JZSP-C7PA2E-03-E	
			5 m	JZSP-C7PA0E-05-E	JZSP-C7PA2E-05-E	
			10 m	JZSP-C7PA0E-10-E	JZSP-C7PA2E-10-E	
			15 m	JZSP-C7PA0E-15-E	JZSP-C7PA2E-15-E	
			20 m	JZSP-C7PA0E-20-E	JZSP-C7PA2E-20-E	

*1. Use Flexible Cables for moving parts of machines, such as robots. The recommended bending radius (R) is 90 mm or larger.

*2. If a battery is connected to the host controller, the Battery Case is not required. If so, use a cable for incremental encoders.

◆ Relay Encoder Cable of 30 m to 50 m

Servomotor Model	Name	Length (L)	Order Number	Appearance
All SGM7J models	Encoder-end Cable (for all types of encoders) Cable installed toward load	0.3 m	JZSP-C7PRCD-E	
	Encoder-end Cable (for all types of encoders) Cable installed away from load	0.3 m	JZSP-C7PRCE-E	
	Cables with Connectors on Both Ends (for all types of encoders)	30 m	JZSP-UCMP00-30-E	
		40 m	JZSP-UCMP00-40-E	
		50 m	JZSP-UCMP00-50-E	
Cable with a Battery Case (Required when an absolute encoder is used.*)	0.3 m	JZSP-CSP12-E		

* This Cable is not required if you use a Servomotor with a Batteryless Absolute Encoder, and you connect a battery to the host controller.

MEMO

SGM7A

Model Designations

Without Gears

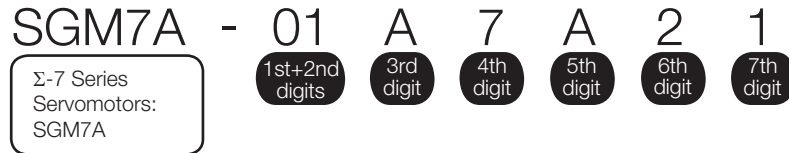

1st+2nd digits Rated Output

Code	Specification
A5	50 W
01	100 W
C2	150 W
02	200 W
04	400 W
06	600 W
08	750 W
10	1.0 kW
15	1.5 kW
20	2.0 kW
25	2.5 kW
30	3.0 kW
40	4.0 kW
50	5.0 kW
70	7.0 kW

3rd digit Power Supply Voltage

Code	Specification
A	200 VAC

4th digit Serial Encoder

Code	Specification
6	24-bit batteryless absolute
7	24-bit absolute
F	24-bit incremental

5th digit Design Revision Order

A

6th digit Shaft End

Code	Specification
2	Straight without key
6	Straight with key and tap
B*	With two flat seats

* Code B is not supported for models with a rated output of 1.5 kW or higher.

7th digit Options

Code	Specification
1	Without options
C	With holding brake (24 VDC)
E	With oil seal and holding brake (24 VDC)
S	With oil seal

Note: SGM7A-70A Servomotors with holding brakes are not available.

With Gears

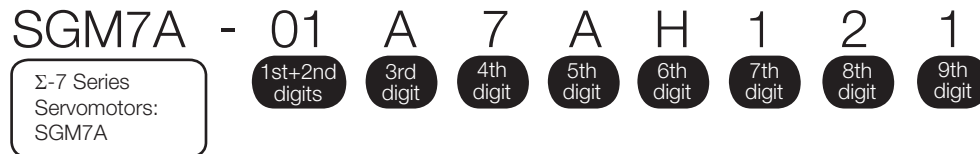

1st+2nd digits Rated Output

Code	Specification
A5	50 W
01	100 W
C2	150 W
02	200 W
04	400 W
06	600 W
08	750 W
10	1.0 kW

4th digit Serial Encoder

Code	Specification
6	24-bit batteryless absolute
7	24-bit absolute
F	24-bit incremental

Note: Contact your Yaskawa representative for models of 1.5 kW or higher.

5th digit Design Revision Order

A

6th digit Gear Type

Code	Specification
H	HDS planetary low-backlash gear

7th digit Gear Ratio

Code	Specification
B	1/11*1
C	1/21
1	1/5
2	1/9*2
7	1/33

*1. This specification is not supported for models with a rated output of 50 W.

*2. This specification is supported only for models with a rated output of 50 W.

3rd digit Power Supply Voltage

Code	Specification
A	200 VAC

8th digit Shaft End

Code	Specification
0	Flange output
2	Straight without key
6	Straight with key and tap

9th digit Options

Code	Specification
1	Without options
C	With holding brake (24 VDC)

Specifications and Ratings

Specifications

Voltage		200 V									
Model SGM7A-	A5A	01A	C2A, 02A	04A	06A, 08A	10A	15A	20A	25A, 30A	40A, 50A	70A
Time Rating	Continuous										
Thermal Class	UL: B, CE: B						UL: F, CE: F				
Insulation Resistance	500 VDC, 10 MΩ min.										
Withstand Voltage	1,500 VAC for 1 minute										
Excitation	Permanent magnet										
Mounting	Flange-mounted										
Drive Method	Direct drive										
Rotation Direction	Counterclockwise (CCW) for forward reference when viewed from the load side										
Vibration Class*1	V15										
Environmental Conditions	Surrounding Air Temperature	0°C to 40°C (With derating, usage is possible between 40°C and 60°C.)*3									
	Surrounding Air Humidity	20% to 80% relative humidity (with no condensation)									
	Installation Site	<ul style="list-style-type: none"> • Must be indoors and free of corrosive and explosive gases. • Must be well-ventilated and free of dust and moisture. • Must facilitate inspection and cleaning. • Must have an altitude of 1,000 m or less. (With derating, usage is possible between 1,000 m and 2,000 m.)*3 • Must be free of strong magnetic fields. 									
	Storage Environment	Store the Servomotor in the following environment if you store it with the power cable disconnected. Storage Temperature: -20°C to 60°C (with no freezing) Storage Humidity: 20% to 80% relative humidity (with no condensation)									
Shock Resistance*2	Impact Acceleration Rate at Flange	490 m/s ²									
	Number of Impacts	2 times									
Vibration Resistance*2	Vibration Acceleration Rate at Flange	49 m/s ² (Models 15A to 50A: 24.5 m/s ² front to back)									14.7 m/s ²
Applicable SERVOPACKs	SGD7S-	R70A, R70F	R90A, R90F	1R6A, 2R1F	2R8A, 2R8F	5R5A	120A	180A	200A	330A	550A
	SGD7W-SGD7C-	1R6A*4, 2R8A*4		1R6A, 2R8A*4	2R8A, 5R5A*4, 7R6A*4	5R5A, 7R6A	-				

*1. A vibration class of V15 indicates a vibration amplitude of 15 μm maximum on the Servomotor without a load at the rated motor speed.

*2. The given values are for when the Servomotor shaft is mounted horizontally and shock or vibration is applied in the directions shown in the following figures.

The strength of the vibration that the Servomotor can withstand depends on the application. Always check the vibration acceleration rate that is applied to the Servomotor with the actual equipment.

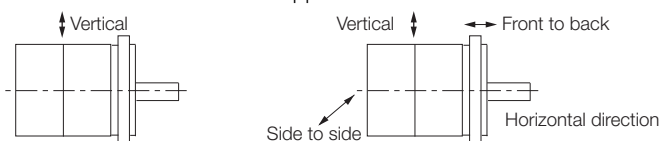

Shock Applied to the Servomotor

Vibration Applied to the Servomotor

*3. Refer to the following section for the derating rates.

 **Derating Rates (page 48)**

*4. If you use a Servomotor together with a Σ-7W or Σ-7C SERVOPACK, the control gain may not increase as much as with a Σ-7S SERVOPACK and other performances may be lower than those achieved with a Σ-7S SERVOPACK.

Ratings of Servomotors without Gears

Voltage		200 V								
Model SGM7A-		A5A	01A	C2A	02A	04A	06A	08A	10A	
Rated Output* ¹	W	50	100	150	200	400	600	750	1000	
Rated Torque* ^{1, *2}	N·m	0.159	0.318	0.477	0.637	1.27	1.91	2.39	3.18	
Instantaneous Maximum Torque* ¹	N·m	0.557	1.11	1.67	2.23	4.46	6.69	8.36	11.1	
Rated Current* ¹	Arms	0.57	0.89	1.5	1.5	2.4	4.5	4.4	6.4	
Instantaneous Maximum Current* ¹	Arms	2.1	3.2	5.6	5.9	9.3	16.9	16.8	23.2	
Rated Motor Speed* ¹	min ⁻¹	3000								
Maximum Motor Speed* ¹	min ⁻¹	6000								
Torque Constant	N·m/Arms	0.304	0.384	0.332	0.458	0.576	0.456	0.584	0.541	
Motor Moment of Inertia	×10 ⁻⁴ kg·m ²	0.0217	0.0337	0.0458	0.139	0.216	0.315	0.775	0.971	
With holding brake		0.0297	0.0417	0.0538	0.209	0.286	0.385	0.955	1.15	
With batteryless absolute encoder		0.0232	0.0352	0.0473	0.140	0.217	0.316	0.776	0.972	
Rated Power Rate* ¹	kW/s	11.7	30.0	49.7	29.2	74.7	115	73.7	104	
With holding brake		8.51	24.2	42.2	19.4	56.3	94.7	59.8	87.9	
Rated Angular Acceleration Rate* ¹	rad/s ²	73200	94300	104000	45800	58700	60600	30800	32700	
With holding brake		53500	76200	88600	30400	44400	49600	25000	27600	
Derating Rate for Servomotor with Oil Seal	%	80	90			95				
Heat Sink Size (Aluminum)* ³	mm	200 × 200 × 6		250 × 250 × 6			300 × 300 × 12* ⁹	250 × 250 × 6	300 × 300 × 12	
Protective Structure* ⁴	Totally enclosed, self-cooled, IP67									
Holding Brake Specifications* ⁵	Rated Voltage	V	24 VDC±10%							
	Capacity	W	5.5			6		6.5		
	Holding Torque	N·m	0.159	0.318	0.477	0.637	1.27	1.91	2.39	3.18
	Coil Resistance	Ω (at 20°C)	104.8±10%			96±10%		88.6±10%		
	Rated Current	A (at 20°C)	0.23			0.25		0.27		
	Time Required to Release Brake	ms	60					80		
	Time Required to Brake	ms	100							
Allowable Load Moment of Inertia (Motor Moment of Inertia Ratio)* ⁶			40 times		30 times	20 times		20 times		
	With External Regenerative Resistor and External Dynamic Brake Resistor* ⁷		40 times		30 times	20 times		30 times		
Allowable Shaft Loads* ⁸	LF	mm	20		25		35			
	Allowable Radial Load	N	78		245		392			
	Allowable Thrust Load	N	54		74		147			

*1. These values are for operation in combination with a SERVOPACK when the temperature of the armature winding is 100°C. The values for other items are at 20°C. These are typical values.

*2. The rated torques are the continuous allowable torque values at a surrounding air temperature of 40°C with an aluminum heat sink of the dimensions given in the table.

*3. Refer to the following section for the relation between the heat sinks and derating rate.

 **Servomotor Heat Dissipation Conditions (page 48)**

*4. This does not apply to the shaft opening. Protective structure specifications apply only when the special cable is used.

*5. Observe the following precautions if you use a Servomotor with a Holding Brake.

- The holding brake cannot be used to stop the Servomotor.
- The time required to release the brake and the time required to brake depend on which discharge circuit is used. Confirm that the operation delay time is appropriate for the actual equipment.
- The 24-VDC power supply is not provided by Yaskawa.

*6. The motor moment of inertia scaling factor is the value for a standard Servomotor without a Holding Brake.

*7. To externally connect a dynamic brake resistor, select hardware option specification 020 for the SERVOPACK. However, you cannot externally connect a dynamic brake resistor if you use the following SERVOPACKs (maximum applicable motor capacity: 400 W).

- SGD7S-R70□□□A020 to -2R8□□□A020
- SGD7W-1R6A20A020 to -2R8A20A020
- SGD7C-1R6AMAA020 to -2R8AMAA020

*8. Design the mechanical system so that the thrust and radial loads applied to the Servomotor shaft end during operation do not exceed the values given in the table.

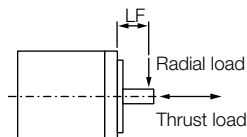

*9. If the heat sink is 250 mm × 250 mm × 6 mm, the rated output is 550 W and the rated torque is 1.75 N·m. Refer to the following section for details.

 **Servomotor Heat Dissipation Conditions (page 48)**

Torque-Motor Speed Characteristics

A : Continuous duty zone ——— (solid lines): With three-phase 200-V or single-phase 230-V input
B : Intermittent duty zone - - - - (dotted lines): With single-phase 200-V input
 - · - · (dashed-dotted lines): With single-phase 100-V input

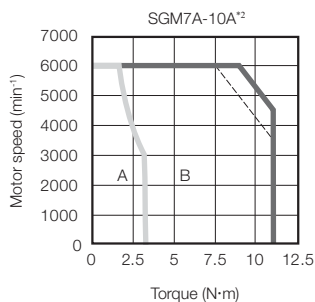
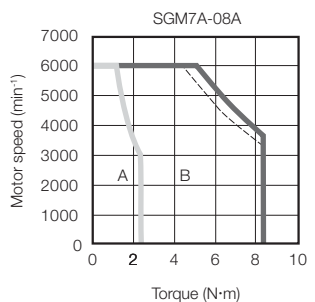
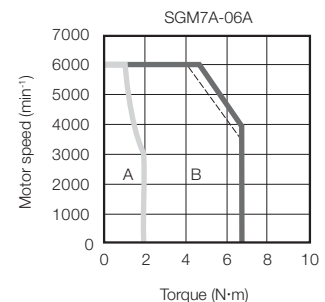
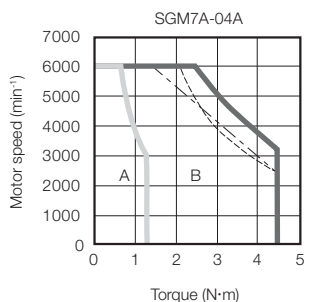
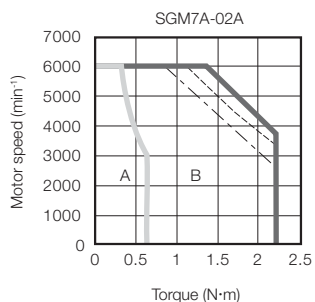
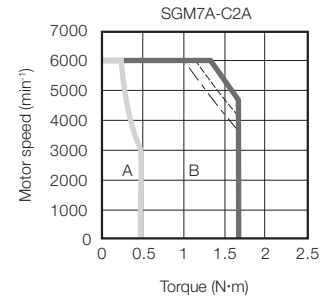
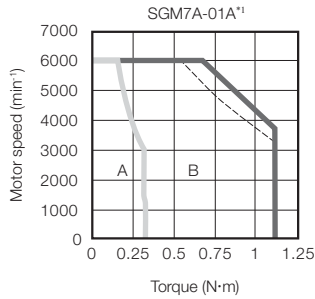
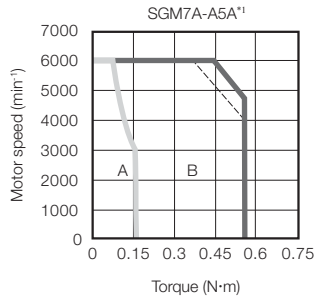

*1. The characteristics are the same for single-phase 200 V and single-phase 100 V input.

*2. A single-phase power input can be used in combination with the SGD7S-120A□□A008.

Note: 1. These values (typical values) are for operation in combination with a SERVOPACK when the temperature of the armature winding is 100°C.

2. The characteristics in the intermittent duty zone depend on the power supply voltage.
3. If the effective torque is within the allowable range for the rated torque, the Servomotor can be used within the intermittent duty zone.
4. If you use a Servomotor Main Circuit Cable that exceeds 20 m, the intermittent duty zone in the torque-motor speed characteristics will become smaller because the voltage drop increases.

Ratings of Servomotors without Gears

Voltage		200 V							
Model SGM7A-		15A	20A	25A	30A	40A	50A	70A	
Rated Output* ¹	kW	1.5	2.0	2.5	3.0	4.0	5.0	7.0	
Rated Torque* ^{1, *2}	N·m	4.90	6.36	7.96	9.80	12.6	15.8	22.3	
Instantaneous Maximum Torque* ¹	N·m	14.7	19.1	23.9	29.4	37.8	47.6	54.0	
Rated Current* ¹	Arms	9.3	12.1	15.6	17.9	25.4	27.6	38.3	
Instantaneous Maximum Current* ¹	Arms	28	42	51	56	77	84	105	
Rated Motor Speed* ¹	min ⁻¹	3000							
Maximum Motor Speed* ¹	min ⁻¹	6000* ⁹							
Torque Constant	N·m/Arms	0.590	0.561	0.538	0.582	0.519	0.604	0.604	
Motor Moment of Inertia		2.00	2.47	3.19	7.00	9.60	12.3	12.3	
	With holding brake	2.25	2.72	3.44	9.20	11.8	14.5	-	
	With batteryless absolute encoder	2.00	2.47	3.19	7.00	9.60	12.3	12.3	
Rated Power Rate* ¹	kW/s	120	164	199	137	165	203	404	
	With holding brake	106	148	184	104	134	172	-	
Rated Angular Acceleration Rate* ¹	rad/s ²	24500	25700	24900	14000	13100	12800	18100	
	With holding brake	21700	23300	23100	10600	10600	10800	-	
Heat Sink Size (Aluminum)* ³	mm	300 × 300 × 12			400 × 400 × 20				
Protective Structure* ⁴		Totally enclosed, self-cooled, IP67						Totally enclosed, separately cooled (with fan), IP22	
Holding Brake Specifications* ⁵	Rated Voltage	V	24 VDC ^{+10%} ₀						-
	Capacity	W	12			10			
	Holding Torque	N·m	7.84		10		20		
	Coil Resistance	Ω (at 20°C)	48			59			
	Rated Current	A (at 20°C)	0.5			0.41			
	Time Required to Release Brake	ms	170			100			
	Time Required to Brake	ms	80						
Allowable Load Moment of Inertia (Motor Moment of Inertia Ratio)* ⁶		10 times			5 times				
	With External Regenerative Resistor and External Dynamic Brake Resistor* ⁷	20 times			15 times				
Allowable Shaft Loads* ⁸	LF	mm	45			63			
	Allowable Radial Load	N	686		980	1176			
	Allowable Thrust Load	N	196			392			

*1. These values are for operation in combination with a SERVOPACK when the temperature of the armature winding is 20°C. These are typical values.

*2. The rated torques are the continuous allowable torque values at a surrounding air temperature of 40°C with an aluminum heat sink of the dimensions given in the table.

*3. Refer to the following section for the relation between the heat sinks and derating rate.

 **Servomotor Heat Dissipation Conditions (page 48)**

*4. This does not apply to the shaft opening. Protective structure specifications apply only when the special cable is used.

*5. Observe the following precautions if you use a Servomotor with a Holding Brake.

- The holding brake cannot be used to stop the Servomotor.
- The time required to release the brake and the time required to brake depend on which discharge circuit is used. Confirm that the operation delay time is appropriate for the actual equipment.
- The 24-VDC power supply is not provided by Yaskawa.

*6. The motor moment of inertia scaling factor is the value for a standard Servomotor without a Holding Brake.

*7. To externally connect a dynamic brake resistor, select hardware option specification 020 for the SERVOPACK. However, you cannot externally connect a dynamic brake resistor if you use the following SERVOPACKS (maximum applicable motor capacity: 400 W).

- SGD7S-R70□□□A020 to -2R8□□□A020
- SGD7W-1R6A20A020 to -2R8A20A020
- SGD7C-1R6AMAA020 to -2R8AMAA020

*8. Design the mechanical system so that the thrust and radial loads applied to the Servomotor shaft end during operation do not exceed the values given in the table.

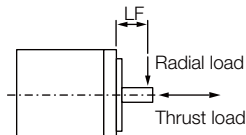

*9. For the SGM7A-25A or SGM7A-50A, the maximum motor speed for the continuous duty zone is 5,000 min⁻¹. Use the Servomotor within the continuous duty zone for the average motor speed and effective torque.

Torque-Motor Speed Characteristics

A : Continuous duty zone — (solid lines): With three-phase 200-V or single-phase 230-V input
B : Intermittent duty zone - - - (dotted lines): With single-phase 200-V input

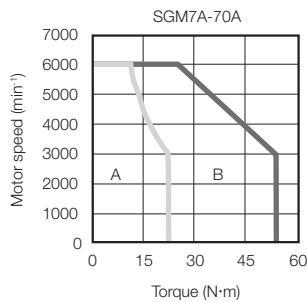
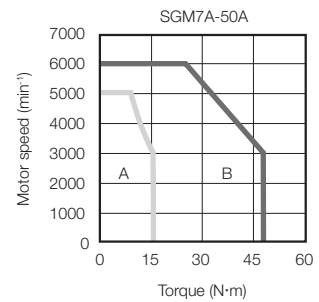
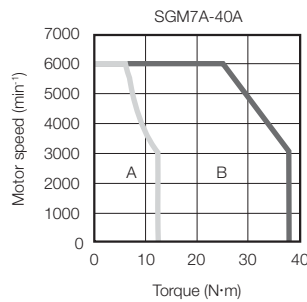
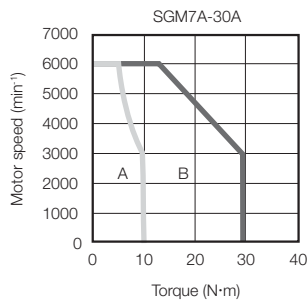
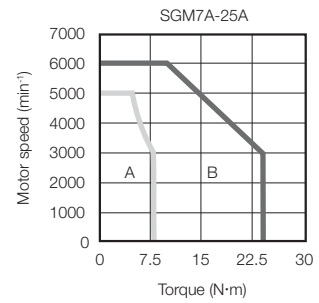
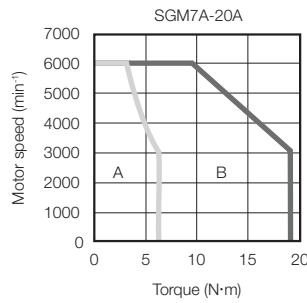
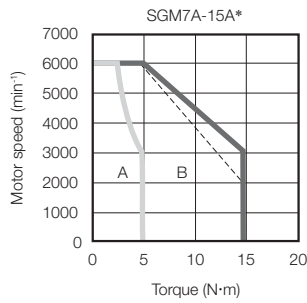

* A single-phase power input can be used in combination with the SGD7S-120A□□A008.

Note: 1. These values (typical values) are for operation in combination with a SERVOPACK when the temperature of the armature winding is 20°C.

2. The characteristics in the intermittent duty zone depend on the power supply voltage.
3. If the effective torque is within the allowable range for the rated torque, the Servomotor can be used within the intermittent duty zone.
4. If you use a Servomotor Main Circuit Cable that exceeds 20 m, the intermittent duty zone in the torque-motor speed characteristics will become smaller because the voltage drop increases.

Ratings of Servomotors with Gears

All Models	Gear Mechanism		Protective Structure		Lost Motion [arc-min]	
	Planetary gear mechanism		Totally enclosed, self-cooled, IP55 (except for shaft opening)		3 max.	

Servomotor Model SGM7A-	Servomotor					Gear Output				
	Rated Output [W]	Rated Motor Speed [min ⁻¹]	Maximum Motor Speed [min ⁻¹]	Rated Torque [N·m]	Instantaneous Maximum Torque [N·m]	Gear Ratio	Rated Torque/Efficiency* ¹ [N·m/%]	Instantaneous Maximum Torque [N·m]	Rated Motor Speed [min ⁻¹]	Maximum Motor Speed [min ⁻¹]
A5A□AH1□	50	3000	6000	0.159	0.557	1/5	0.433/64* ²	2.37	600	1200
A5A□AH2□						1/9	1.12/78	3.78* ³	333	667
A5A□AHC□						1/21	2.84/85	10.6	143	286
A5A□AH7□						1/33	3.68/70	15.8	91	182
01A□AH1□	100	3000	6000	0.318	1.11	1/5	1.06/78* ²	4.96	600	1200
01A□AHB□						1/11	2.52/72	10.7	273	545
01A□AHC□						1/21	5.35/80	20.8	143	286
01A□AH7□						1/33	7.35/70	32.7	91	182
C2A□AH1□	150	3000	6000	0.477	1.67	1/5	1.68/83* ²	7.80	600	1200
C2A□AHB□						1/11	3.53/79* ²	16.9	273	545
C2A□AHC□						1/21	6.30/70* ²	31.0	143	286
C2A□AH7□						1/33	11.2/79* ²	49.7	91	182
02A□AH1□	200	3000	6000	0.637	2.23	1/5	2.39/75	9.80	600	1200
02A□AHB□						1/11	5.74/82	22.1	273	545
02A□AHC□						1/21	10.2/76	42.1	143	286
02A□AH7□						1/33	17.0/81	67.6	91	182
04A□AH1□	400	3000	6000	1.27	4.46	1/5	5.35/84	20.1	600	1200
04A□AHB□						1/11	11.5/82	45.1	273	545
04A□AHC□						1/21	23.0/86	87.0	143	286
04A□AH7□						1/33	34.0/81	135	91	182
06A□AH1□	600	3000	6000	1.91	6.69	1/5	7.54/79	30.5	600	1200
06A□AHB□						1/11	18.1/86	68.6	273	545
06A□AHC□						1/21	32.1/80	129	143	286
06A□AH7□						1/33	53.6/85	206	91	182
08A□AH1□	750	3000	6000	2.39	8.36	1/5	10.0/84	38.4	600	1200
08A□AHB□						1/11	23.1/88	86.4	273	545
08A□AHC□						1/21	42.1/84	163	143	286
08A□AH7□						1/33	69.3/88	259	91	182
10A□AH1□	1000	3000	6000	3.18	11.1	1/5	13.7/86	52.5	600	1200
10A□AHB□						1/11	29.1/83	111	273	545
10A□AHC□						1/21	58.2/87	215	143	286
10A□AH7□						1/33	94.5/90	296* ³	91	182

*1. The gear output torque is expressed by the following formula.

$$\text{Gear output torque} = \text{Servomotor output torque} \times \frac{1}{\text{Gear ratio}} \times \text{Efficiency}$$

The gear efficiency depends on operating conditions such as the output torque, motor speed, and temperature. The values in the table are typical values for the rated torque, rated motor speed, and a surrounding air temperature of 25°C. They are reference values only.

*2. When using an SGM7A-A5A, SGM7A-01A, or SGM7A-C2A Servomotor with a gear ratio of 1/5 or an SGM7A-C2A Servomotor with a gear ratio of 1/11, maintain an 85% maximum effective load ratio. For an SGM7A-C2A Servomotor with a gear ratio of 1/21 or 1/33, maintain a 90% maximum effective load ratio. The values in the table take the effective load ratio into consideration.

*3. The instantaneous maximum torque is 300% of the rated torque.

Note: 1. The gears that are mounted to Yaskawa Servomotors have not been broken in.

Break in the Servomotor if necessary. First, operate the Servomotor at low speed with no load. If no problems occur, gradually increase the speed and load.

2. The no-load torque for a Servomotor with a Gear is high immediately after the Servomotor starts, and it then decreases and becomes stable after a few minutes. This is a common phenomenon caused by grease circulation in the gears and it does not indicate faulty gears.

3. Contact your Yaskawa representative for information on Servomotor with Gears with a rated output of 1.5 kW or higher.

4. Other specifications are the same as those for Servomotors without Gears.



Important

The SERVOPACK speed control range is 1:5,000. If you use Servomotors at extremely low speeds (0.02 min⁻¹ or lower at the gear output shaft), if you use Servomotors with a one-pulse feed reference for extended periods, or under some other operating conditions, the gear bearing lubrication may be insufficient. That may cause deterioration of the bearing or increase the load ratio. Contact your Yaskawa representative if you use a Servomotor under these conditions.

Servomotor Model SGM7A-	Moment of Inertia [$\times 10^{-4}$ kg·m ²]				With Gears			Reference Diagram
	Shaft Output		Flange Output		Allowable Radial Load [N]	Allowable Thrust Load [N]	LF [mm]	
	Motor* + Gear	Gear	Motor* + Gear	Gear				
A5A□AH1□	0.0277	0.006	0.0267	0.005	95	431	37	
A5A□AH2□	0.0247	0.003	0.0247	0.003	113	514	37	
A5A□AHC□	0.0257	0.004	0.0257	0.004	146	663	37	
A5A□AH7□	0.0667	0.045	0.0667	0.045	267	1246	53	
01A□AH1□	0.0397	0.006	0.0387	0.005	95	431	37	
01A□AHB□	0.0937	0.060	0.0927	0.059	192	895	53	
01A□AHC□	0.0837	0.050	0.0837	0.050	233	1087	53	
01A□AH7□	0.0987	0.065	0.0977	0.064	605	2581	75	
C2A□AH1□	0.0518	0.006	0.0508	0.005	95	431	37	
C2A□AHB□	0.106	0.060	0.105	0.059	192	895	53	
C2A□AHC□	0.156	0.110	0.154	0.108	528	2254	75	
C2A□AH7□	0.111	0.065	0.110	0.064	605	2581	75	
02A□AH1□	0.346	0.207	0.340	0.201	152	707	53	
02A□AHB□	0.332	0.193	0.331	0.192	192	895	53	
02A□AHC□	0.629	0.490	0.627	0.488	528	2254	75	
02A□AH7□	0.589	0.450	0.588	0.449	605	2581	75	
04A□AH1□	0.423	0.207	0.417	0.201	152	707	53	
04A□AHB□	0.786	0.570	0.776	0.560	435	1856	75	
04A□AHC□	0.706	0.490	0.704	0.488	528	2254	75	
04A□AH7□	0.836	0.620	0.826	0.610	951	4992	128	
06A□AH1□	1.02	0.700	0.975	0.660	343	1465	75	
06A□AHB□	0.885	0.570	0.875	0.560	435	1856	75	
06A□AHC□	1.16	0.840	1.14	0.820	830	4359	128	
06A□AH7□	0.935	0.620	0.925	0.610	951	4992	128	
08A□AH1□	1.48	0.700	1.44	0.660	343	1465	75	
08A□AHB□	1.38	0.600	1.37	0.590	435	1856	75	
08A□AHC□	3.78	3.00	3.76	2.98	830	4359	128	
08A□AH7□	3.58	2.80	3.57	2.79	951	4992	128	
10A□AH1□	1.67	0.700	1.63	0.660	343	1465	75	
10A□AHB□	4.37	3.40	4.31	3.34	684	3590	128	
10A□AHC□	3.97	3.00	3.95	2.98	830	4359	128	
10A□AH7□	3.77	2.80	3.76	2.79	951	4992	128	

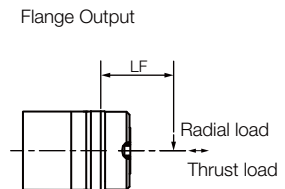
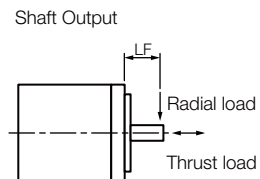

* The moment of inertia for the Servomotor and gear is the value without a holding brake. You can calculate the moment of inertia for a Servomotor with a Gear and Holding Brake with the following formula.

Motor moment of inertia for a Servomotor with a Holding Brake from *Ratings of Servomotors without Gears* (page 40) + Moment of inertia for the gear from the above table.



Important

During operation, the gear generates the loss at the gear mechanism and oil seal. The loss depends on the torque and motor speed conditions. The temperature rise depends on the loss and heat dissipation conditions. For the heat dissipation conditions, always refer to the following table and check the gear and motor temperatures with the actual equipment. If the temperature is too high, implement the following measures.

- Decrease the load ratio.
- Change the heat dissipation conditions.
- Use forced-air cooling for the motor with a cooling fan or other means.

Model	Heat Sink Size			
	1/5	1/9 or 1/11	1/21	1/33
SGM7A-A5	A			
SGM7A-01	B			
SGM7A-C2				
SGM7A-02	C			
SGM7A-04				
SGM7A-06				
SGM7A-08				
SGM7A-10A				

- A: 250 mm × 250 mm × 6 mm, aluminum plate
- B: 300 mm × 300 mm × 12 mm, aluminum plate
- C: 350 mm × 350 mm × 12 mm, aluminum plate

Servomotor Overload Protection Characteristics

The overload detection level is set for hot start conditions with a Servomotor surrounding air temperature of 40°C.

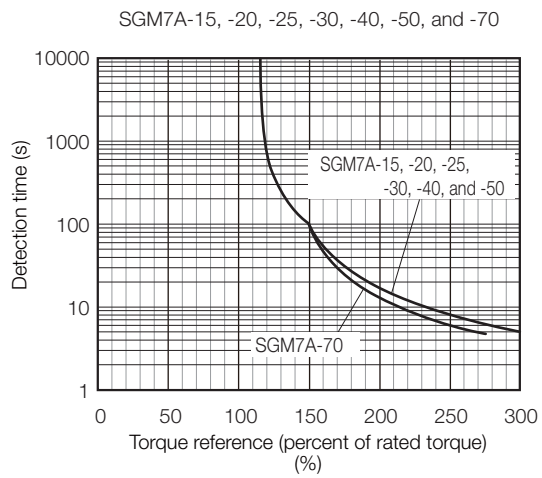
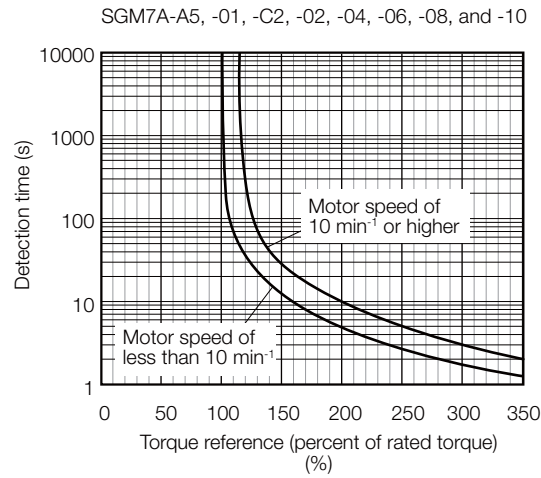

Note: The above overload protection characteristics do not mean that you can perform continuous duty operation with an output of 100% or higher. Use the Servomotor so that the effective torque remains within the continuous duty zone given in *Torque-Motor Speed Characteristics* on page 41 or page 43.

Allowable Load Moment of Inertia

The allowable load moments of inertia (motor moment of inertia ratios) for the Servomotors are given in the *Ratings of Servomotors without Gears* (pages 40 and 42). The values are determined by the regenerative energy processing capacity of the SERVOPACK and are also affected by the drive conditions of the Servomotor. Perform the required Steps for each of the following cases.

Use the SigmaSize+ AC Servo Drive Capacity Selection Program to check the driving conditions. Contact your Yaskawa representative for information on this program.

◆ Exceeding the Allowable Load Moment of Inertia

Use one of the following measures to adjust the load moment of inertia to within the allowable value.

- Reduce the torque limit.
- Reduce the deceleration rate.
- Reduce the maximum motor speed.

If the above steps is not possible, install an external regenerative resistor.

Information An Overvoltage Alarm (A.400) is likely to occur during deceleration if the load moment of inertia exceeds the allowable load moment of inertia. SERVOPACKs with a built-in regenerative resistor may generate a Regenerative Overload Alarm (A.320). Refer to *Built-In Regenerative Resistor* (page 472) for the regenerative power (W) that can be processed by the SERVOPACKs.
Install an External Regenerative Resistor when the built-in regenerative resistor cannot process all of the regenerative power.

◆ SERVOPACKs without Built-in Regenerative Resistors

The following graph shows the allowable load moment of inertia scaling factor of the motor speed (reference values for deceleration operation at or above the rated torque). Application is possible without an external regenerative resistor within the allowable value. However, an External Regenerative Resistor is required in the shaded areas of the graphs.

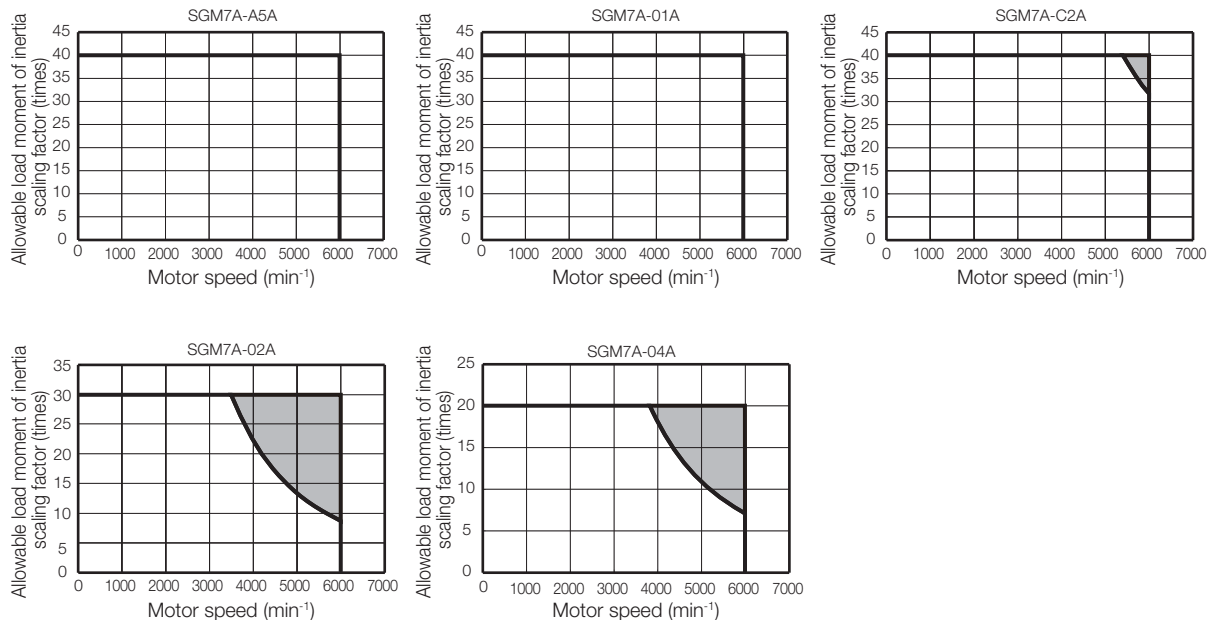

Note: Applicable SERVOPACK models: SGD7S-R70A, -R90A, -1R6A, -2R8A, -R70F, -R90F, -2R1F, and -2R8F

◆ When an External Regenerative Resistor Is Required

Install the External Regenerative Resistor. Refer to the following section for the recommended products.

External Regenerative Resistors (page 472)

Derating Rates

◆ Servomotor Heat Dissipation Conditions

The Servomotor ratings are the continuous allowable values at a surrounding air temperature of 40°C when a heat sink is installed on the Servomotor. If the Servomotor is mounted on a small device component, the Servomotor temperature may rise considerably because the surface for heat dissipation becomes smaller. Refer to the following graphs for the relation between the heat sink size and derating rate.

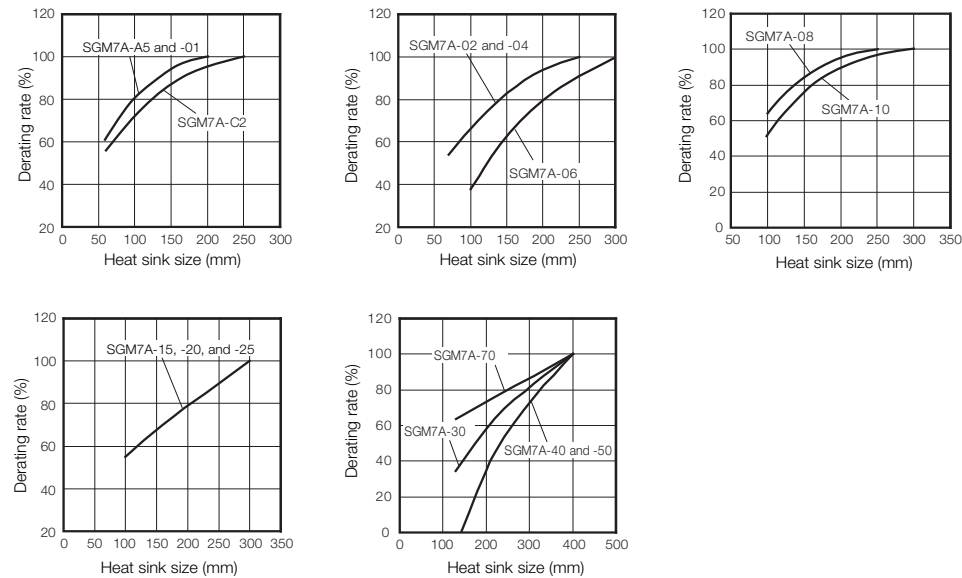

Important

The actual temperature rise depends on how the heat sink (i.e., the Servomotor mounting section) is attached to the installation surface, what material is used for the Servomotor mounting section, and the motor speed. Always check the Servomotor temperature with the actual equipment.

◆ Applications Where the Surrounding Air Temperature Exceeds 40°C

The Servomotor ratings are the continuous allowable values at a surrounding air temperature of 40°C. If you use a Servomotor at a surrounding air temperature that exceeds 40°C (60°C max.), apply a suitable derating rate from the following graphs.

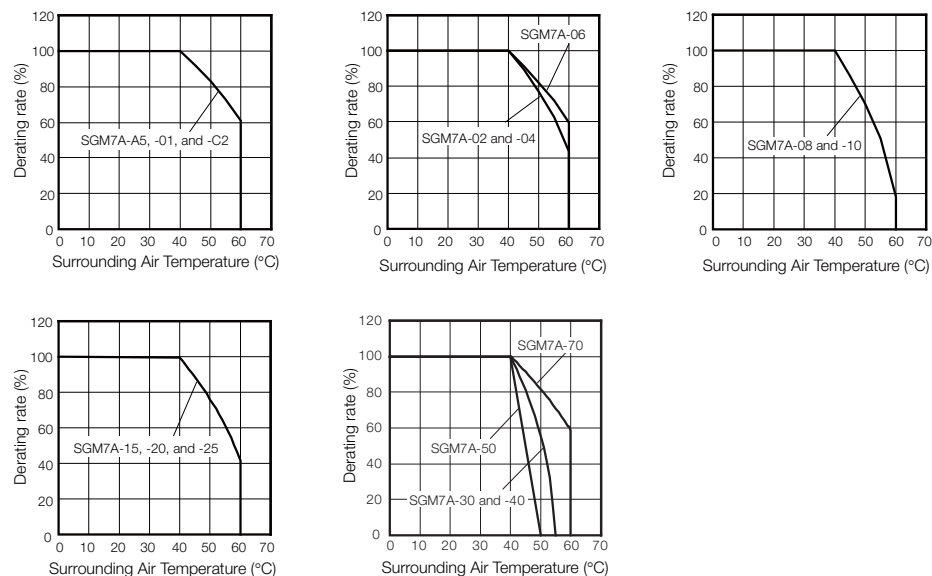

◆ Applications Where the Altitude Exceeds 1,000 m

The Servomotor ratings are the continuous allowable values at an altitude of 1,000 m or less. If you use a Servomotor at an altitude that exceeds 1,000 m (2,000 m max.), the heat dissipation effect of the air is reduced. Apply the appropriate derating rate from the following graphs.

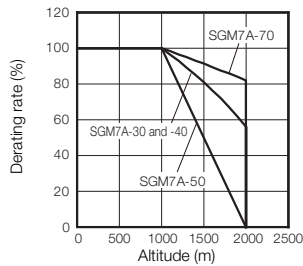
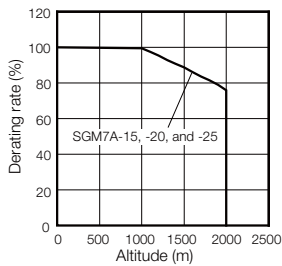
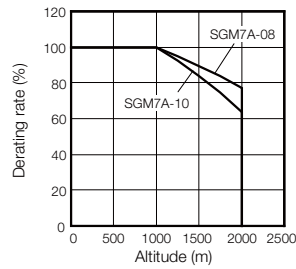
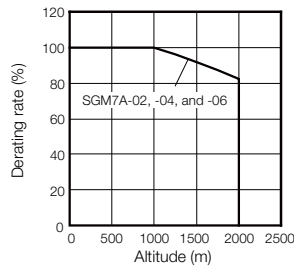
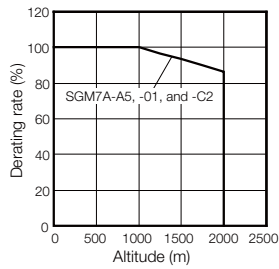

Information

When using Servomotors with derating, change the detection timing of overload warning and overload alarm based on the overload detection level of the motor given in *Servomotor Overload Protection Characteristics* (page 46).

- Note: 1. Use the combination of the SERVOPACK and Servomotor so that the derating conditions are satisfied for both the SERVOPACK and Servomotor.
2. The derating rates are applicable only when the average motor speed is less than or equal to the rated motor speed. If the average motor speed exceeds the rated motor speed, consult with your Yaskawa representative.

External Dimensions

Servomotors without Gears

◆ SGM7A-A5, -01, and -C2

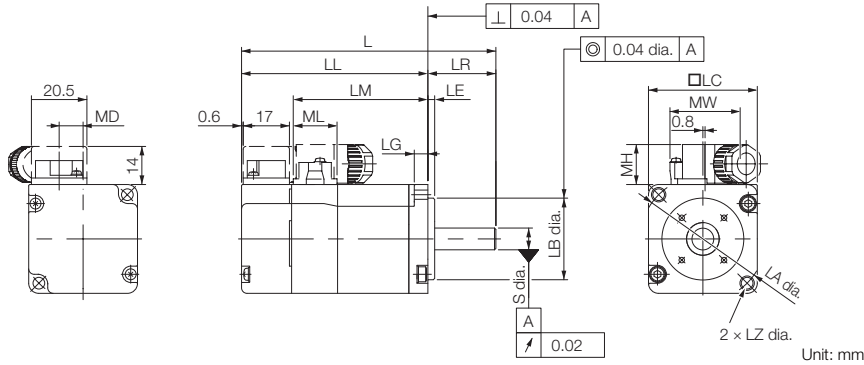

Model SGM7A-	L*	LL*	LM	Flange Dimensions							S	MD	MW	MH	ML	Approx. Mass [kg]
				LR	LE	LG	LC	LA	LB	LZ						
A5A□A2□	81.5 (122)	56.5 (97)	37.9	25	2.5	5	40	46	30 ⁰ _{-0.021}	4.3	8 ⁰ _{-0.009}	8.8	25.8	14.7	16.1	0.3 (0.6)
01A□A2□	93.5 (134)	68.5 (109)	49.9	25	2.5	5	40	46	30 ⁰ _{-0.021}	4.3	8 ⁰ _{-0.009}	8.8	25.8	14.7	16.1	0.4 (0.7)
C2A□A2□	105.5 (153.5)	80.5 (128.5)	61.9	25	2.5	5	40	46	30 ⁰ _{-0.021}	4.3	8 ⁰ _{-0.009}	8.8	25.8	14.7	16.1	0.5 (0.8)

* For models that have a batteryless absolute encoder, L and LL are 8 mm greater than the given value. Refer to the following section for the values for individual models.

 *Dimensions of Servomotors with Batteryless Absolute Encoders (page 64)*

Note: 1. The values in parentheses are for Servomotors with Holding Brakes.

2. The values for a straight, without key specification are given. Refer to the information given below for other shaft end specifications and option specifications.

■ Shaft End Specifications

- Straight with Key and Tap

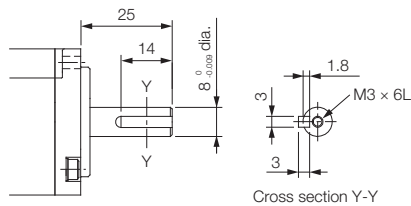

- With Two Flat Seats

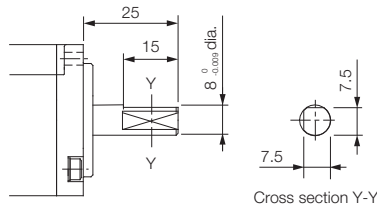

■ Specifications of Options

- Oil Seal

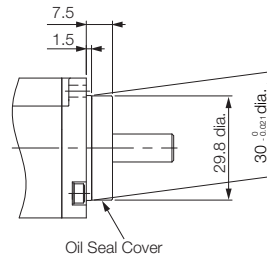

■ Connector Mounting Dimensions

- Cable Installed on Load Side

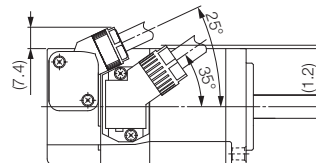

- Cable Installed on Non-load Side

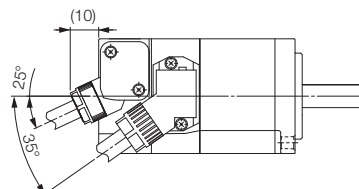

◆ SGM7A-02, -04, and -06

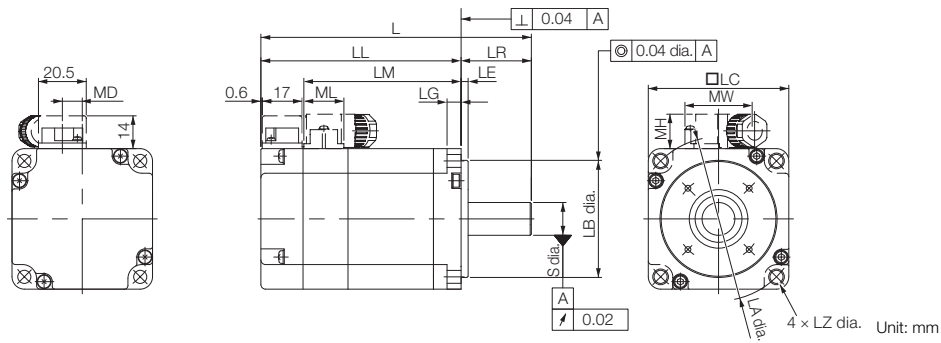

Model SGM7A-	L*	LL*	LM	Flange Dimensions							S	MD	MW	MH	ML	Approx. Mass [kg]
				LR	LE	LG	LC	LA	LB	LZ						
02A□A2□	99.5 (140)	69.5 (110)	51.2	30	3	6	60	70	50 ⁰ _{-0.025}	5.5	14 ⁰ _{-0.011}	8.5	28.7	14.7	17.1	0.8 (1.4)
04A□A2□	115.5 (156)	85.5 (126)	67.2	30	3	6	60	70	50 ⁰ _{-0.025}	5.5	14 ⁰ _{-0.011}	8.5	28.7	14.7	17.1	1.2 (1.8)
06A□A2□	137.5 (191.5)	107.5 (161.5)	89.2	30	3	6	60	70	50 ⁰ _{-0.025}	5.5	14 ⁰ _{-0.011}	8.5	28.7	14.7	17.1	1.6 (2.2)

* For models that have a batteryless absolute encoder, L and LL are 8 mm greater than the given value. Refer to the following section for the values for individual models.

📏 **Dimensions of Servomotors with Batteryless Absolute Encoders (page 64)**

Note: 1. The values in parentheses are for Servomotors with Holding Brakes.

2. The values for a straight, without key specification are given. Refer to the information given below for other shaft end specifications and option specifications.

■ Shaft End Specifications

- Straight with Key and Tap

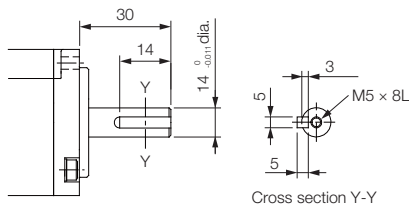

- With Two Flat Seats

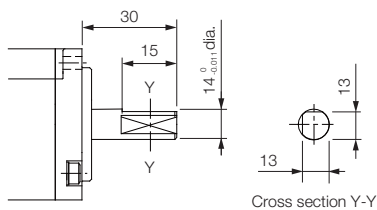

■ Specifications of Options

- Oil Seal

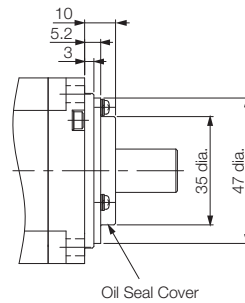

■ Connector Mounting Dimensions

- Cable Installed on Load Side

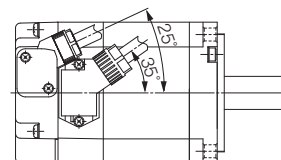

- Cable Installed on Non-load Side

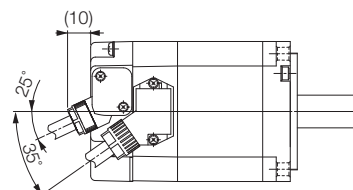

◆ SGM7A-08 and -10

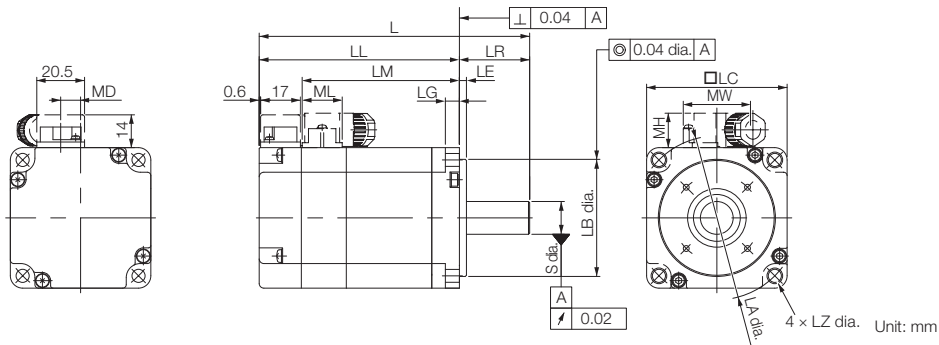

Model SGM7A-	L*	LL*	LM	Flange Dimensions						S	MD	MW	MH	ML	Approx. Mass* [kg]	
				LR	LE	LG	LC	LA	LB							LZ
08A□A2□	137 (184)	97 (144)	78.5	40	3	8	80	90	70 ⁰ _{-0.030}	7	19 ⁰ _{-0.013}	13.6	38	14.7	19.3	2.3 (2.9)
10A□A2□	162 (209)	122 (169)	103.5	40	3	8	80	90	70 ⁰ _{-0.030}	7	19 ⁰ _{-0.013}	13.6	38	14.7	19.3	3.1 (3.7)

* For models that have a batteryless absolute encoder, L and LL are 8 mm greater and the approximate mass is 0.1 kg greater than the given value. Refer to the following section for the values for individual models.

📖 *Dimensions of Servomotors with Batteryless Absolute Encoders (page 64)*

Note: 1. The values in parentheses are for Servomotors with Holding Brakes.

2. The values for a straight, without key specification are given. Refer to the information given below for other shaft end specifications and option specifications.

■ Shaft End Specifications

- Straight with Key and Tap

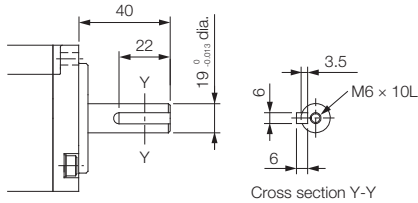

- With Two Flat Seats

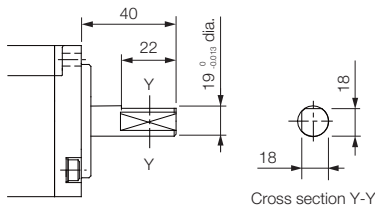

■ Specifications of Options

- Oil Seal

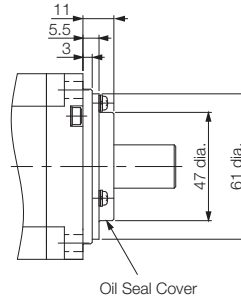

■ Connector Mounting Dimensions

- Cable Installed on Load Side

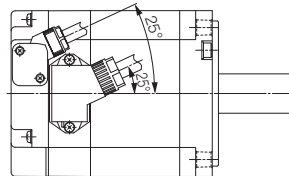

- Cable Installed on Non-load Side

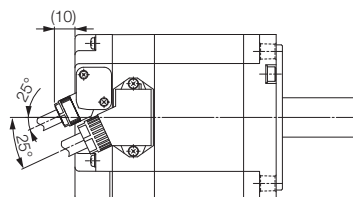

Servomotors without Gears and without Holding Brakes

◆ SGM7A-15, -20, and -25

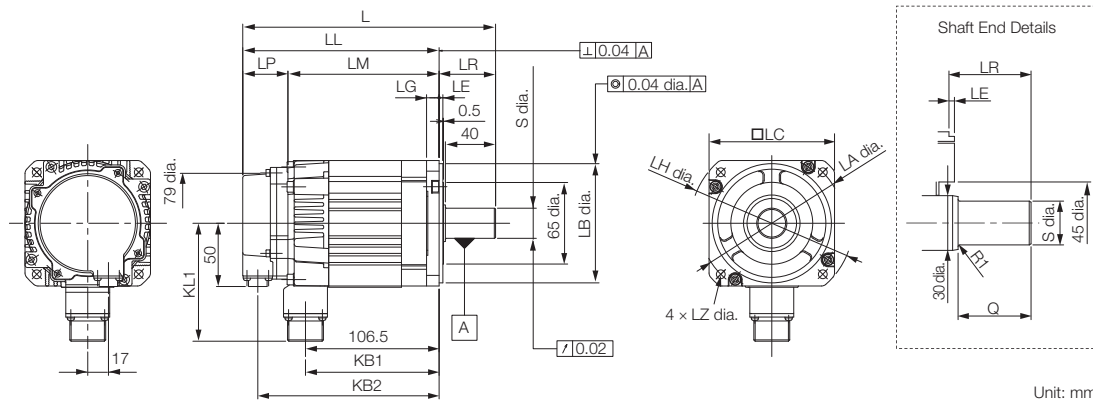

Model SGM7A-	L*	LL*	LM	LP*	LR	KB1	KB2*	KL1
15A□A21	202	157	121	36	45	107	145	94
20A□A21	218	173	137	36	45	123	161	94
25A□A21	241	196	160	36	45	146	184	94

Model SGM7A-	Flange Dimensions							Shaft End Dimensions		Approx. Mass [kg]
	LA	LB	LC	LE	LG	LH	LZ	S	Q	
15A□A21	115	95 ⁰ _{-0.035}	100	3	10	130	7	24 ⁰ _{-0.013}	40	4.6
20A□A21	115	95 ⁰ _{-0.035}	100	3	10	130	7	24 ⁰ _{-0.013}	40	5.4
25A□A21	115	95 ⁰ _{-0.035}	100	3	10	130	7	24 ⁰ _{-0.013}	40	6.8

* For models that have a batteryless absolute encoder, L, LL, LP, and KB2 are 8 mm greater than the given value. Refer to the following section for the values for individual models.

📖 *Dimensions of Servomotors with Batteryless Absolute Encoders (page 64)*

Note: 1. The values in parentheses are for Servomotors with Holding Brakes.

2. The values for a straight, without key specification are given. Refer to the information given below for other shaft end specifications and option specifications.

■ Shaft End Specifications

• Straight with Key and Tap

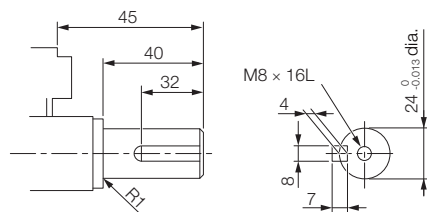

■ Connector Specifications

• Encoder Connector (24-bit Encoder)

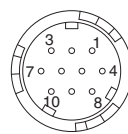

1	PS	6*	BAT(+)
2	/PS	7	-
3	-	8	-
4	PG5V	9	PG0V
5*	BAT(-)	10	FG (frame ground)

* A battery is required only for an absolute encoder.

Receptacle: CM10-R10P-D

Applicable plug: Not provided by Yaskawa.

Plug: CM10-AP10S-□-D for Right-angle Plug

CM10-SP10S-□-D for Straight Plug

(□ depends on the applicable cable size.)

Manufacturer: DDK Ltd.

• Servomotor Connector

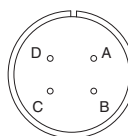

A	Phase U	C	Phase W
B	Phase V	D	FG (frame ground)

Manufacturer: DDK Ltd.

◆ SGM7A-30, -40, and -50

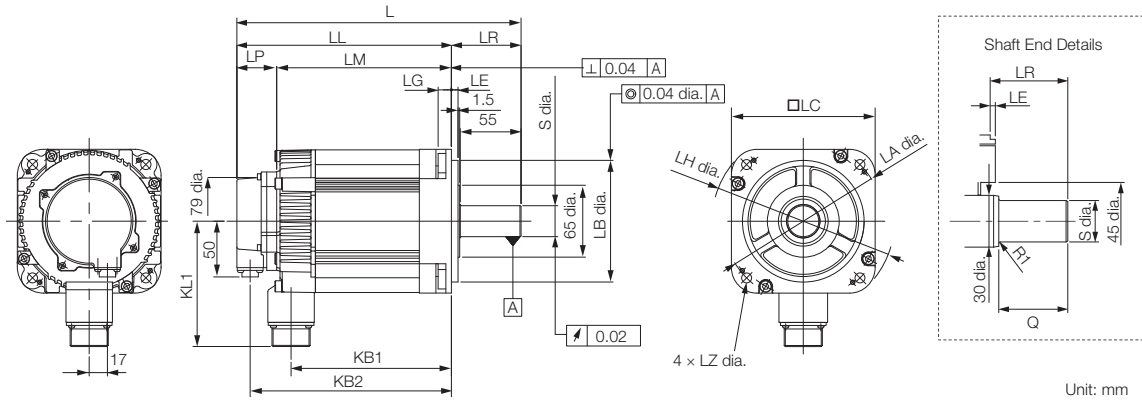

Model SGM7A-	L*	LL*	LM	LP*	LR	KB1	KB2*	KL1
30A□A21	257	194	158	36	63	145	182	114
40A□A21	296	233	197	36	63	184	221	114
50A□A21	336	273	237	36	63	224	261	114

Model SGM7A-	Flange Dimensions							Shaft End Dimensions		Approx. Mass [kg]
	LA	LB	LC	LE	LG	LH	LZ	S	Q	
30A□A21	145	110 ⁰ _{-0.035}	130	6	12	165	9	28 ⁰ _{-0.013}	55	10.5
40A□A21	145	110 ⁰ _{-0.035}	130	6	12	165	9	28 ⁰ _{-0.013}	55	13.5
50A□A21	145	110 ⁰ _{-0.035}	130	6	12	165	9	28 ⁰ _{-0.013}	55	16.5

* For models that have a batteryless absolute encoder, L, LL, LP, and KB2 are 8 mm greater than the given value. Refer to the following section for the values for individual models.

📏 *Dimensions of Servomotors with Batteryless Absolute Encoders (page 64)*

Note: 1. The values in parentheses are for Servomotors with Holding Brakes.

2. The values for a straight, without key specification are given. Refer to the information given below for other shaft end specifications and option specifications.

■ Shaft End Specifications

- Straight with Key and Tap

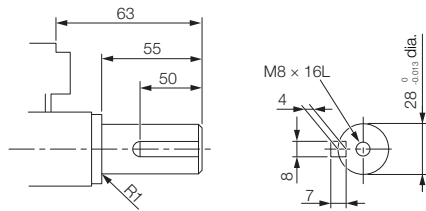

■ Connector Specifications

- Encoder Connector (24-bit Encoder)

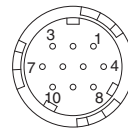

1	PS	6*	BAT(+)
2	/PS	7	-
3	-	8	-
4	PG5V	9	PG0V
5*	BAT(-)	10	FG (frame ground)

* A battery is required only for an absolute encoder.

Receptacle: CM10-R10P-D

Applicable plug: Not provided by Yaskawa.

Plug: CM10-AP10S-□-D for Right-angle Plug

CM10-SP10S-□-D for Straight Plug

(□ depends on the applicable cable size.)

Manufacturer: DDK Ltd.

- Servomotor Connector

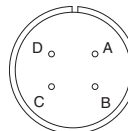

A	Phase U	C	Phase W
B	Phase V	D	FG (frame ground)

Manufacturer: DDK Ltd.

◆ SGM7A-70

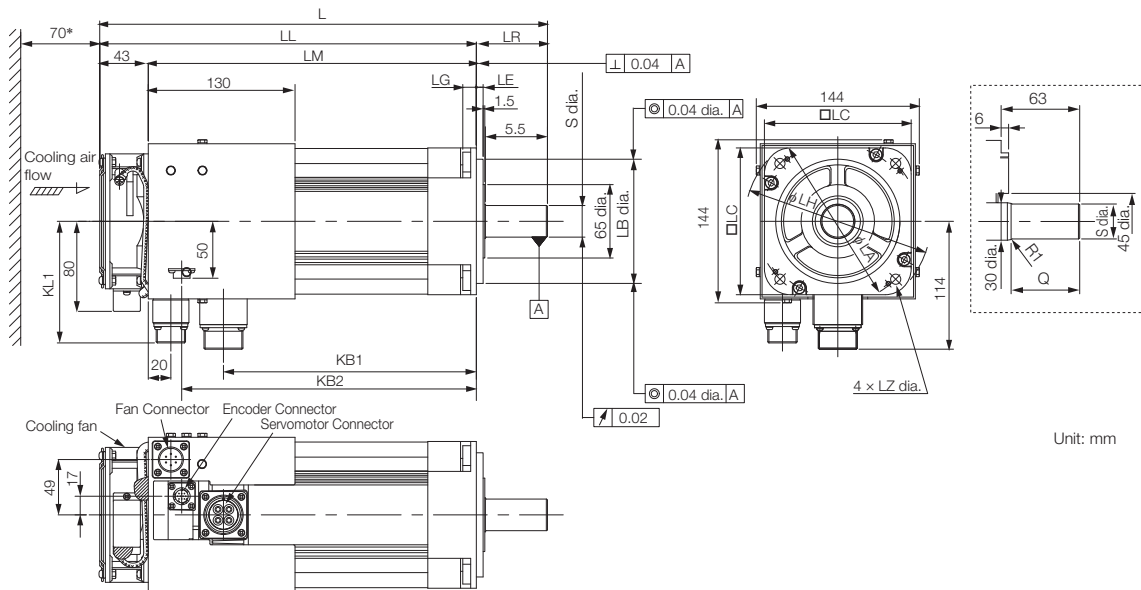

* Leave a minimum space of 70 mm around the Servomotor from walls and other equipment to allow for a sufficient amount of cooling air.

Model SGM7A-	L	LL	LM	LR	KB1	KB2*	KL1	Flange Dimensions						Shaft End Dimensions		Approx. Mass [kg]	
								LA	LB	LC	LE	LG	LH	LZ	S		Q
70A□A21	397	334	291	63	224	261	108	145	110 ⁰ _{-0.035}	130	6	12	165	9	28 ⁰ _{-0.013}	55	18.5

* For models that have a batteryless absolute encoder, KB is 8 mm greater than the given value. Refer to the following section for the values for individual models.

☞ *Dimensions of Servomotors with Batteryless Absolute Encoders (page 64)*

Note: 1. The values in parentheses are for Servomotors with Holding Brakes.

2. The values for a straight, without key specification are given. Refer to the information given below for other shaft end specifications and option specifications.

■ Cooling Fan Specifications

Single-phase, 220 V
50/60 Hz
17/15 W
0.11/0.09 A

■ Specifications of Fan Operation Error Detector

Contact Capacity

Maximum allowable voltage: 350 V (AC/DC)
Maximum allowable current: 120 mA (AC/DC)
Maximum controllable power: 360 mW

Alarm Contacts

ON for normal fan rotation.
OFF at 1,680 ± 100 min⁻¹ max.
OFF for 3 seconds at startup.

■ Shaft End Specifications

• Straight with Key and Tap

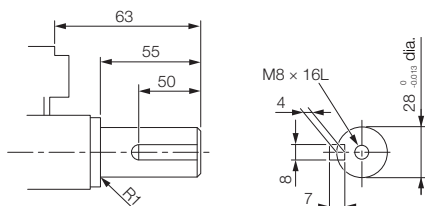

■ Connector Specifications

• Encoder Connector (24-bit Encoder)

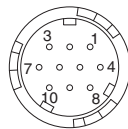

1	PS	6*	BAT(+)
2	/PS	7	-
3	-	8	-
4	PG5V	9	PG0V
5*	BAT(-)	10	FG (frame ground)

* A battery is required only for an absolute encoder.

Receptacle: CM10-R10P-D

Applicable plug: Not provided by Yaskawa.

Plug: CM10-AP10S-□-D for Right-angle Plug
CM10-SP10S-□-D for Straight Plug

(□ depends on the applicable cable size.)

Manufacturer: DDK Ltd.

• Servomotor Connector

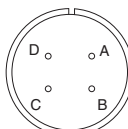

A	Phase U	C	Phase W
B	Phase V	D	FG (frame ground)

Manufacturer: DDK Ltd.

• Fan Connector

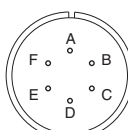

A	Fan motor	D	Alarm pin
B	Fan motor	E	Alarm pin
C	-	F	FG (frame ground)

Receptacle: MS3102A14S-6P

Applicable Plug (Available from Yaskawa Controls Co., Ltd.)

Plug: MS3108B14S-6S

Cable Clamp: MS3057-6A

Note: The Servomotor Connector (receptacle) is RoHS compliant. Contact the connector manufacturer for RoHS-compliant cable-side connectors (not provided by Yaskawa).

Servomotors without Gears and with Holding Brakes

◆ SGM7A-15 to -25

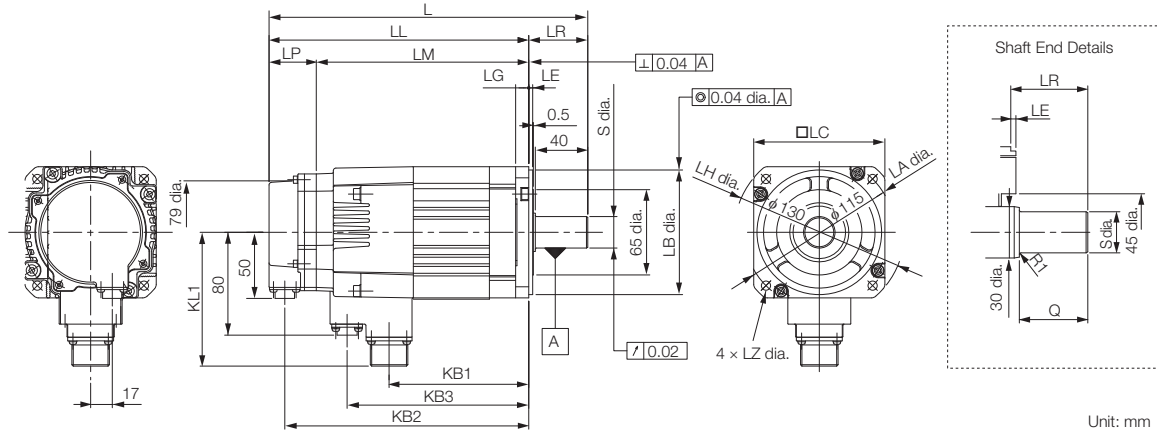

Unit: mm

Model SGM7A-	L*	LL*	LM	LP*	LR	KB1	KB2*	KB3	KL1
15A□A2C	243	198	162	36	45	107	186	139	102
20A□A2C	259	214	178	36	45	123	202	155	102
25A□A2C	292	247	211	36	45	156	235	188	102

Model SGM7A-	Flange Dimensions							Shaft End Dimensions		Approx. Mass [kg]
	LA	LB	LC	LE	LG	LH	LZ	S	Q	
15A□A2C	115	95 ⁰ _{-0.035}	100	3	10	130	7	24 ⁰ _{-0.013}	40	6.0
20A□A2C	115	95 ⁰ _{-0.035}	100	3	10	130	7	24 ⁰ _{-0.013}	40	6.8
25A□A2C	115	95 ⁰ _{-0.035}	100	3	10	130	7	24 ⁰ _{-0.013}	40	8.7

* For models that have a batteryless absolute encoder, L, LL, LP, and KB2 are 8 mm greater than the given value. Refer to the following section for the values for individual models.

📏 Dimensions of Servomotors with Batteryless Absolute Encoders (page 64)

Note: 1. The values in parentheses are for Servomotors with Holding Brakes.

2. The values for a straight, without key specification are given. Refer to the information given below for other shaft end specifications and option specifications.

■ Shaft End Specifications

• Straight with Key and Tap

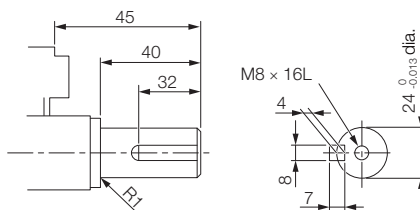

■ Connector Specifications

• Encoder Connector (24-bit Encoder)

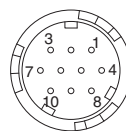

1	PS	6*	BAT(+)
2	/PS	7	-
3	-	8	-
4	PG5V	9	PG0V
5*	BAT(-)	10	FG (frame ground)

* A battery is required only for an absolute encoder.
Receptacle: CM10-R10P-D
Applicable plug: Not provided by Yaskawa.
Plug: CM10-AP10S-□-D for Right-angle Plug
CM10-SP10S-□-D for Straight Plug
(□ depends on the applicable cable size.)
Manufacturer: DDK Ltd.

• Servomotor Connector

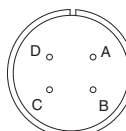

A	Phase U	C	Phase W
B	Phase V	D	FG (frame ground)

Manufacturer: DDK Ltd.

• Brake Connector

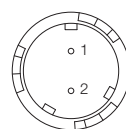

1	Brake terminal
2	Brake terminal

Note: There is no voltage polarity for the brake terminals.

Receptacle: CM10-R10P-D
Applicable plug: Not provided by Yaskawa.
Plug: CM10-AP2S-□-D for Right-angle Plug
CM10-SP2S-□-D for Straight Plug
(□ depends on the applicable cable size.)
Manufacturer: DDK Ltd.

◆ SGM7A-30 to -50

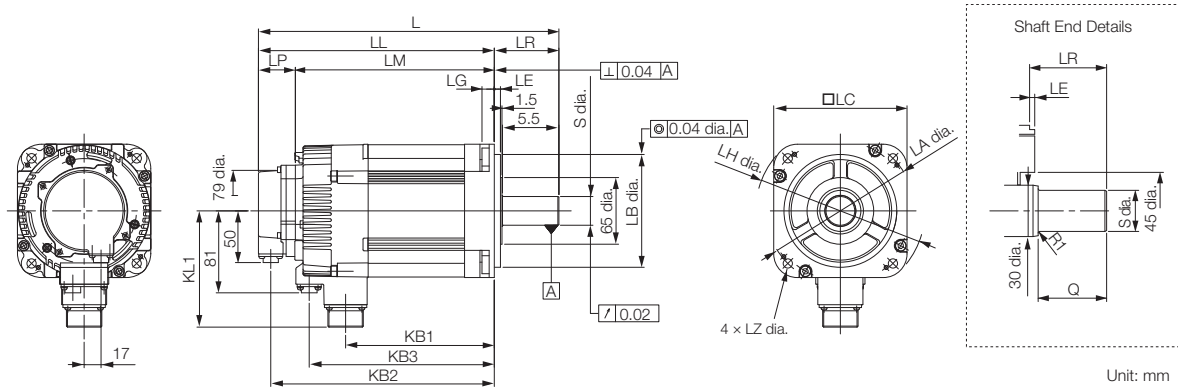

Model SGM7A-	L*	LL*	LM	LP*	LR	KB1	KB2*	KB3	KL1
30A□A2C	293	232	196	36	63	145	220	181	119
40A□A2C	332	269	233	36	63	184	257	220	119
50A□A2C	372	309	273	36	63	224	297	260	119

Model SGM7A-	Flange Dimensions							Shaft End Dimensions		Approx. Mass [kg]
	LA	LB	LC	LE	LG	LH	LZ	S	Q	
30A□A2C	145	110 ⁰ _{-0.035}	130	6	12	165	9	28 ⁰ _{-0.013}	55	13
40A□A2C	145	110 ⁰ _{-0.035}	130	6	12	165	9	28 ⁰ _{-0.013}	55	16
50A□A2C	145	110 ⁰ _{-0.035}	130	6	12	165	9	28 ⁰ _{-0.013}	55	19

* For models that have a batteryless absolute encoder, L, LL, LP, and KB2 are 8 mm greater than the given value. Refer to the following section for the values for individual models.

☞ *Dimensions of Servomotors with Batteryless Absolute Encoders (page 64)*

Note: 1. The values in parentheses are for Servomotors with Holding Brakes.

2. The values for a straight, without key specification are given. Refer to the information given below for other shaft end specifications and option specifications.

■ Shaft End Specifications

- Straight with Key and Tap

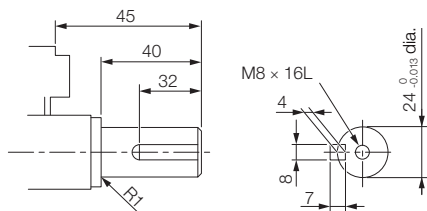

■ Connector Specifications

- Encoder Connector (24-bit Encoder)

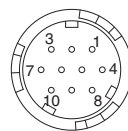

1	PS	6*	BAT(+)
2	/PS	7	-
3	-	8	-
4	PG5V	9	PG0V
5*	BAT(-)	10	FG (frame ground)

* A battery is required only for an absolute encoder.

Receptacle: CM10-R10P-D

Applicable plug: Not provided by Yaskawa.

Plug: CM10-AP10S-□-D for Right-angle Plug

CM10-SP10S-□-D for Straight Plug

(□ depends on the applicable cable size.)

Manufacturer: DDK Ltd.

- Servomotor Connector

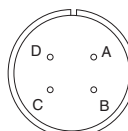

A	Phase U	C	Phase W
B	Phase V	D	FG (frame ground)

Manufacturer: DDK Ltd.

- Brake Connector

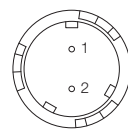

1	Brake terminal
2	Brake terminal

Note: There is no voltage polarity for the brake terminals.

Receptacle: CM10-R10P-D

Applicable plug: Not provided by Yaskawa.

Plug: CM10-AP2S-□-D for Right-angle Plug

CM10-SP2S-□-D for Straight Plug

(□ depends on the applicable cable size.)

Manufacturer: DDK Ltd.

Servomotors with Gears

◆ SGM7A-A5, -01, and -C2

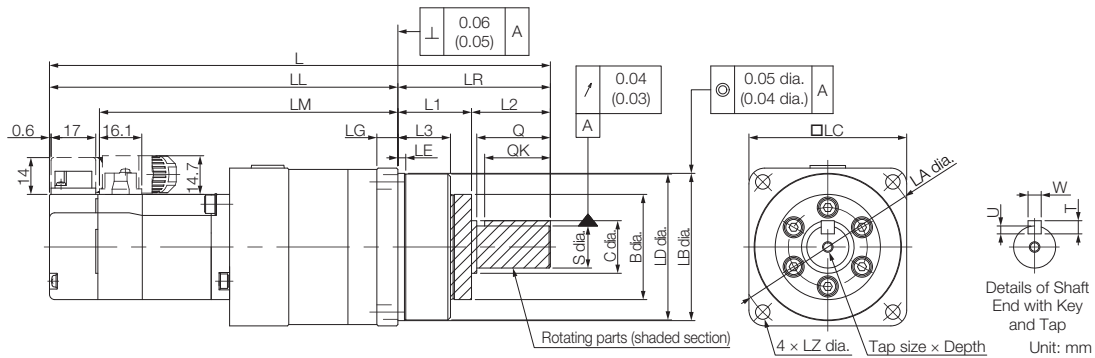

Model SGM7A-	Gear Ratio	L*	LL*	LM	Flange Dimensions								
					LR	LE	LG	B	LD	LB	LC	LA	LZ
A5A□AH1□□	1/5	138	96	77.4	42	2.2	5	29	39.5	40 ⁰ _{-0.025}	40	46	3.4
A5A□AH2□□	1/9	(178.5)	(136.5)										
A5A□AHC□□	1/21	147	105	86.4									
A5A□AH7□□	1/33	178.5	120.5	101.9	58	2.5	8	40	55.5	56 ⁰ _{-0.030}	60	70	5.5
01A□AH1□□	1/5	150	108	89.4	42	2.2	5	29	39.5	40 ⁰ _{-0.025}	40	46	3.4
01A□AHB□□	1/11	190.5	132.5	113.9	58	2.5	8	40	55.5	56 ⁰ _{-0.030}	60	70	5.5
01A□AHC□□	1/21	(231)	(173)										
01A□AH7□□	1/33	215	135	116.4	80	7.5	10	59	84	85 ⁰ _{-0.035}	90	105	9
C2A□AH1□□	1/5	162	120	101.4	42	2.2	5	29	39.5	40 ⁰ _{-0.025}	40	46	3.4
C2A□AHB□□	1/11	202.5	144.5	125.9	58	2.5	8	40	55.5	56 ⁰ _{-0.030}	60	70	5.5
C2A□AHC□□	1/21	227	147	128.4	80	7.5	10	59	84	85 ⁰ _{-0.035}	90	105	9
C2A□AH7□□	1/33	(275)	(195)										

Model SGM7A-	Flange Dimensions			Q	C	S	Tap Size × Depth	Key Dimensions				Approx. Mass [kg]
	L1	L2	L3					QK	U	W	T	
A5A□AH1□□	22	20	14.6	-	-	10 ⁰ _{-0.015}	M3 × 6L	15	2.5	4	4	0.6
A5A□AH2□□												0.7
A5A□AHC□□												(1.0)
A5A□AH7□□	28	30	20	28	20	16 ⁰ _{-0.018}	M4 × 8L	25	3	5	5	1.3
01A□AH1□□	22	20	14.6	-	-	10 ⁰ _{-0.015}	M3 × 6L	15	2.5	4	4	0.7
01A□AHB□□	28	30	20	28	20	16 ⁰ _{-0.018}	M4 × 8L	25	3	5	5	1.4
01A□AHC□□												(1.7)
01A□AH7□□	36	44	26	42	32	25 ⁰ _{-0.021}	M6 × 12L	36	4	8	7	2.8
C2A□AH1□□	22	20	14.6	-	-	10 ⁰ _{-0.015}	M3 × 6L	15	2.5	4	4	0.8
C2A□AHB□□	28	30	20	28	20	16 ⁰ _{-0.018}	M4 × 8L	25	3	5	5	1.5
C2A□AHC□□	36	44	26	42	32	25 ⁰ _{-0.021}	M6 × 12L	36	4	8	7	2.9
C2A□AH7□□												(3.2)

* For models that have a batteryless absolute encoder, L and LL are 8 mm greater than the given value. Refer to the following section for the values for individual models.

Dimensions of Servomotors with Batteryless Absolute Encoders (page 64)

- Note: 1. The values in parentheses are for Servomotors with Holding Brakes.
 2. Gear dimensions are different from those of the Σ, Σ-II, and Σ-III Series.
 3. The values for the shaft end are for a straight shaft with key and tap. If a key and tap are not necessary, specify shaft end code 2 for the 8th digit.

■ Flange Output Face

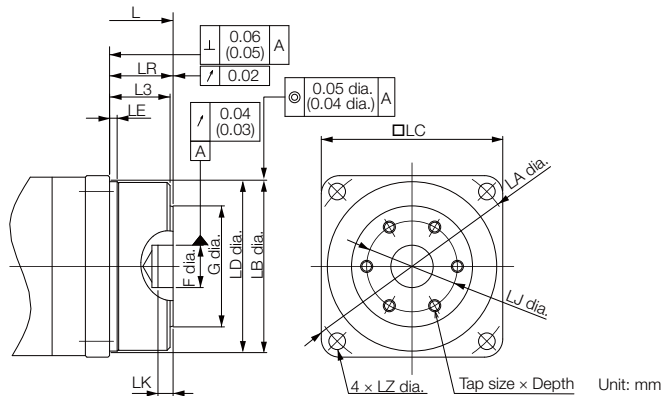

Note: The geometric tolerance in parentheses is the value for LC = 40.

Model SGM7A-	Gear Ratio	L*	LR	LJ	F	G	LK	No. of Taps × Tap Size × Depth	Approx. Mass [kg]
A5A□AH10□	1/5	111	15	18	5 ^{+0.012} ₀	24	3	3 × M4 × 6L	0.6 (0.9)
A5A□AH20□	1/9	(151.5)							
A5A□AHC0□	1/21	120 (160.5)							
A5A□AH70□	1/33	141.5 (182)	21	30	14 ^{+0.018} ₀	40	5	6 × M4 × 7L	1.2 (1.5)
01A□AH10□	1/5	123 (163.5)	15	18	5 ^{+0.012} ₀	24	3	3 × M4 × 6L	0.7 (1.0)
01A□AHB0□	1/11	153.5 (194)	21	30	14 ^{+0.018} ₀	40	5	3 × M4 × 7L	1.3 (1.6)
01A□AHC0□	1/21								
01A□AH70□	1/33	162 (202.5)	27	45	24 ^{+0.021} ₀	59		6 × M6 × 10L	2.4 (2.7)
C2A□AH10□	1/5	135 (183)	15	18	5 ^{+0.012} ₀	24	3	3 × M4 × 6L	0.8 (1.1)
C2A□AHB0□	1/11	165.5 (213.5)	21	30	14 ^{+0.018} ₀	40	5	6 × M4 × 7L	1.4 (1.7)
C2A□AHC0□	1/21	174 (222)	27	45	24 ^{+0.021} ₀	59	5	6 × M6 × 10L	2.5 (2.8)
C2A□AH70□	1/33								

* For models that have a batteryless absolute encoder, L is 8 mm greater than the given value. Refer to the following section for the values for individual models.

📖 **Dimensions of Servomotors with Batteryless Absolute Encoders (page 64)**

Note: 1. The values in parentheses are for Servomotors with Holding Brakes.

2. Dimensions not found in the above table are the same as those in the table on the previous page.



Important

For a Servomotor with a flange output that has square gear flange dimensions (□LC) of 40 mm, we recommend that you design the Servomotor with the dimensions shown in the following figure in order to secure a gap between the gear oil seal and the connecting parts on the load side.

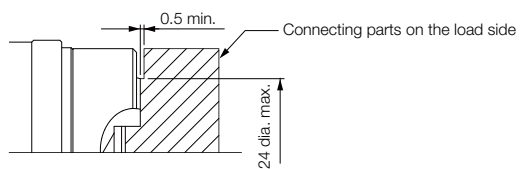

◆ SGM7A-02, -04, and -06

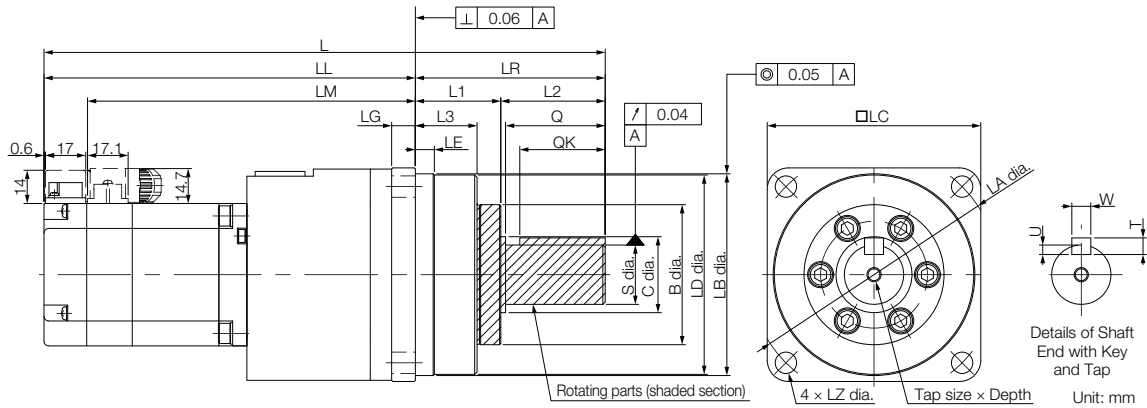

Model SGM7A-	Gear Ratio	L*	LL*	LM	Flange Dimensions								
					LR	LE	LG	B	LD	LB	LC	LA	LZ
02A□AH1□□	1/5	191.5 (232)	133.5 (174)	115.2	58	2.5	8	40	55.5	56 ⁰ _{-0.030}	60	70	5.5
02A□AHB□□	1/11												
02A□AHC□□	1/21	220.5 (261)	140.5 (181)	122.2	80	7.5	10	59	84	85 ⁰ _{-0.035}	90	105	9
02A□AH7□□	1/33												
04A□AH1□□	1/5	207.5 (248)	149.5 (190)	131.2	58	2.5	8	40	55.5	56 ⁰ _{-0.030}	60	70	5.5
04A□AHB□□	1/11	236.5 (277)	156.5 (197)	138.2	80	7.5	10	59	84	85 ⁰ _{-0.035}	90	105	9
04A□AHC□□	1/21												
04A□AH7□□	1/33	322.5 (363)	189.5 (230)	171.2	133	12.5	13	84	114	115 ⁰ _{-0.035}	120	135	11
06A□AH1□□	1/5	258.5 (312.5)	178.5 (232.5)	160.2	80	7.5	10	59	84	85 ⁰ _{-0.035}	90	105	9
06A□AHB□□	1/11												
06A□AHC□□	1/21	344.5 (398.5)	211.5 (265.5)	193.2	133	12.5	13	84	114	115 ⁰ _{-0.035}	120	135	11
06A□AH7□□	1/33												

Model SGM7A-	Flange Dimensions			Q	C	S	Tap Size × Depth	Key Dimensions				Approx. Mass [kg]
	L1	L2	L3					QK	U	W	T	
02A□AH1□□	28	30	20	28	20	16 ⁰ _{-0.018}	M4 × 8L	25	3	5	5	1.8 (2.4)
02A□AHB□□												1.9 (2.5)
02A□AHC□□	36	44	26	42	32	25 ⁰ _{-0.021}	M6 × 12L	36	4	8	7	3.7 (4.3)
02A□AH7□□												
04A□AH1□□	28	30	20	28	20	16 ⁰ _{-0.018}	M4 × 8L	25	3	5	5	2.1 (2.7)
04A□AHB□□	36	44	26	42	32	25 ⁰ _{-0.021}	M6 × 12L	36	4	8	7	4.0 (4.6)
04A□AHC□□												
04A□AH7□□	48	85	33	82	44	40 ⁰ _{-0.025}	M10 × 20L	70	5	12	8	8.6 (9.2)
06A□AH1□□	36	44	26	42	32	25 ⁰ _{-0.021}	M6 × 12L	36	4	8	7	4.3 (4.9)
06A□AHB□□												4.5 (5.1)
06A□AHC□□	48	85	33	82	44	40 ⁰ _{-0.025}	M10 × 20L	70	5	12	8	9.1 (9.7)
06A□AH7□□												

* For models that have a batteryless absolute encoder, L and LL are 8 mm greater than the given value. Refer to the following section for the values for individual models.

📐 Dimensions of Servomotors with Batteryless Absolute Encoders (page 64)

- Note: 1. The values in parentheses are for Servomotors with Holding Brakes.
 2. Gear dimensions are different from those of the Σ, Σ-II, and Σ-III Series.
 3. The values for the shaft end are for a straight shaft with key and tap. If a key and tap are not necessary, specify shaft end code 2 for the 8th digit.

■ Flange Output Face

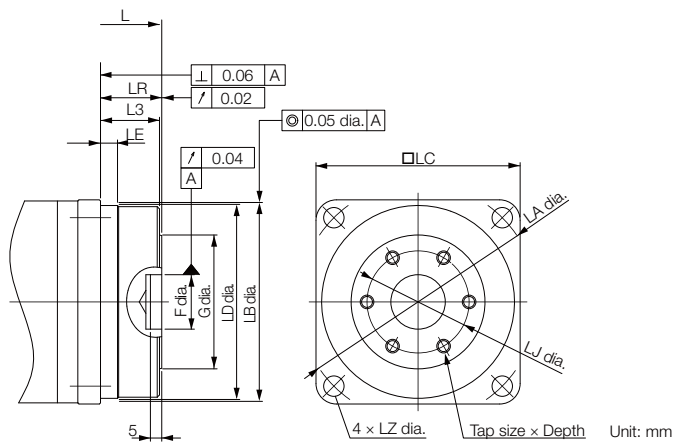

Model SGM7A-	Gear Ratio	L*	LR	LJ	F	G	No. of Taps × Tap Size × Depth	Approx. Mass [kg]
02A□AH10□	1/5	154.5 (195)	21	30	14 ^{+0.018} ₀	40	6 × M4 × 7L	1.7 (2.3)
02A□AB20□	1/11							1.8 (2.4)
02A□AHC0□	1/21	167.5 (208)	27	45	24 ^{+0.021} ₀	59	6 × M6 × 10L	3.3 (3.9)
02A□AH70□	1/33							
04A□AH10□	1/5	170.5 (211)	21	30	14 ^{+0.018} ₀	40	6 × M4 × 7L	2.0 (2.6)
04A□AHB0□	1/11							183.5 (224)
04A□AHC0□	1/21							
04A□AH70□	1/33	224.5 (265)	35	60	32 ^{+0.025} ₀	84	6 × M8 × 12L	7.2 (7.8)
06A□AH10□	1/5	205.5 (259.5)	27	45	24 ^{+0.021} ₀	59	6 × M6 × 10L	3.9 (4.5)
06A□AHB0□	1/11							4.1 (4.7)
06A□AHC0□	1/21	246.5 (300.5)	35	60	32 ^{+0.025} ₀	84	6 × M8 × 12L	7.7 (8.3)
06A□AH70□	1/33							

* For models that have a batteryless absolute encoder, L is 8 mm greater than the given value. Refer to the following section for the values for individual models.

🔧 **Dimensions of Servomotors with Batteryless Absolute Encoders (page 64)**

Note: 1. The values in parentheses are for Servomotors with Holding Brakes.

2. Dimensions not found in the above table are the same as those in the table on the previous page.

◆ SGM7A-08 and -10

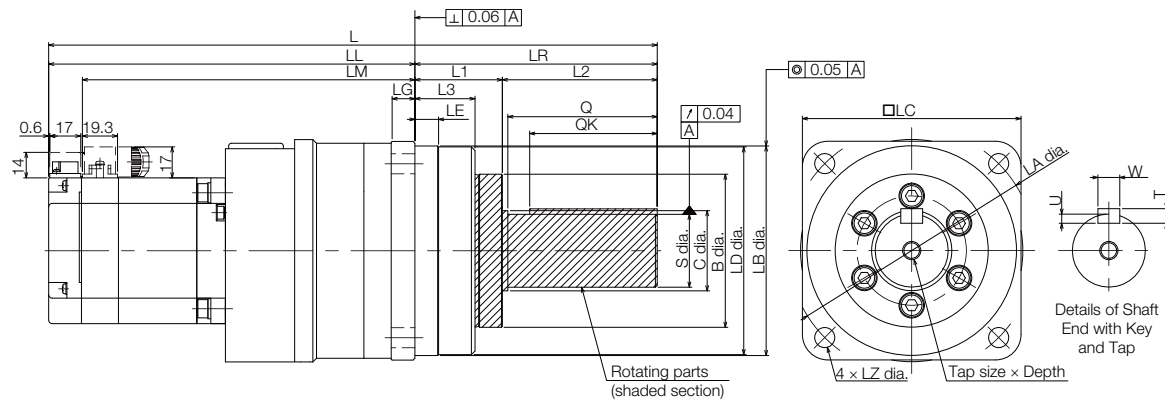

Unit: mm

Model SGM7A-	Gear Ratio	L*	LL*	LM	Flange Dimensions								
					LR	LE	LG	B	LD	LB	LC	LA	LZ
08A□AH1□□	1/5	255	175	156.5	80	7.5	10	59	84	85 ⁰ _{-0.035}	90	105	9
08A□AHB□□	1/11	(302)	(222)										
08A□AHC□□	1/21	334	201	182.5	133	12.5	13	84	114	115 ⁰ _{-0.035}	120	135	11
08A□AH7□□	1/33	(381)	(248)										
10A□AH1□□	1/5	280	200	181.5	80	7.5	10	59	84	85 ⁰ _{-0.035}	90	105	9
10A□AHB□□	1/11	(327)	(247)										
10A□AHC□□	1/21	359	226	207.5	133	12.5	13	84	114	115 ⁰ _{-0.035}	120	135	11
10A□AH7□□	1/33	(406)	(273)										

Model SGM7A-	Flange Dimensions			Q	C	S	Tap Size × Depth	Key Dimensions				Approx. Mass* [kg]
	L1	L2	L3					QK	U	W	T	
08A□AH1□□	36	44	26	42	32	25 ⁰ _{-0.021}	M6 × 12L	36	4	8	7	4.9 (5.8)
08A□AHB□□												5.1 (6.0)
08A□AHC□□	48	85	33	82	44	40 ⁰ _{-0.025}	M10 × 20L	70	5	12	8	9.8 (10.7)
08A□AH7□□												
10A□AH1□□	36	44	26	42	32	25 ⁰ _{-0.021}	M6 × 12L	36	4	8	7	6.0 (6.6)
10A□AHB□□												
10A□AHC□□	48	85	33	82	44	40 ⁰ _{-0.025}	M10 × 20L	70	5	12	8	10.9 (11.5)
10A□AH7□□												

* For models that have a batteryless absolute encoder, L and LL are 8 mm greater and the approximate mass is 0.1 kg greater than the given value. Refer to the following section for the values for individual models.

📐 **Dimensions of Servomotors with Batteryless Absolute Encoders (page 64)**

Note: 1. The values in parentheses are for Servomotors with Holding Brakes.

2. Gear dimensions are different from those of the Σ, Σ-II, and Σ-III Series.

3. The values for the shaft end are for a straight shaft with key and tap. If a key and tap are not necessary, specify shaft end code 2 for the 8th digit.

■ Flange Output Face

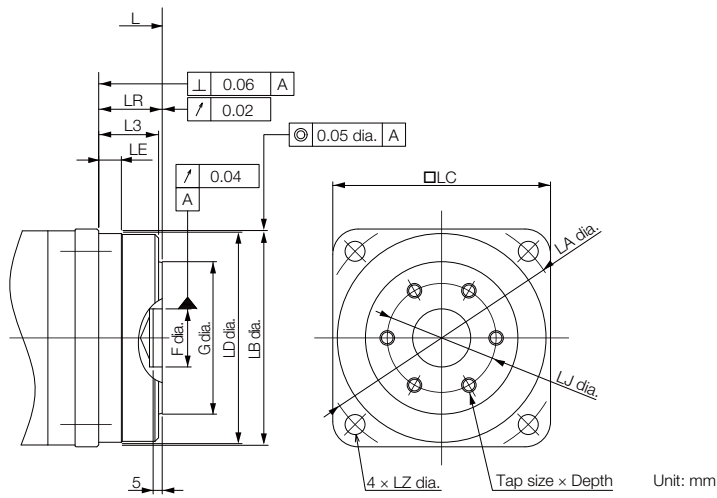

Model SGM7A-	Gear Ratio	L*	LR	LJ	F	G	No. of Taps × Tap Size × Depth	Approx. Mass* [kg]
08A□AH10□	1/5	202 (249)	27	45	24 ^{+0.021} ₀	59	6 × M6 × 10L	4.7 (5.3)
08A□AHB0□	1/11							4.9 (5.5)
08A□AHC0□	1/21	236 (283)	35	60	32 ^{+0.025} ₀	84	6 × M8 × 12L	8.6 (9.2)
08A□AH70□	1/33							
10A□AH10□	1/5	227 (274)	27	45	24 ^{+0.021} ₀	59	6 × M6 × 10L	5.6 (6.3)
10A□AHB0□	1/11							261 (308)
10A□AHC0□	1/21							
10A□AH70□	1/33							

* For models that have a batteryless absolute encoder, L is 8 mm greater and the approximate mass is 0.1 kg greater than the given value. Refer to the following section for the values for individual models.

Dimensions of Servomotors with Batteryless Absolute Encoders (page 64)

Note: 1. The values in parentheses are for Servomotors with Holding Brakes.

2. Dimensions not found in the above table are the same as those in the table on the previous page.

Dimensions of Servomotors with Batteryless Absolute Encoders

◆ Servomotors without Gears

Model SGM7A-	L	LL	LP	KB2	Approx. Mass [kg]
A5A6A2□	89.5 (130)	64.5 (105)	-	-	0.3 (0.6)
01A6A2□	101.5 (142)	76.5 (117)	-	-	0.4 (0.7)
C2A6A2□	113.5 (161.5)	88.5 (136.5)	-	-	0.5 (0.8)
02A6A2□	107.5 (148)	77.5 (118)	-	-	0.8 (1.4)
04A6A2□	123.5 (164)	93.5 (134)	-	-	1.2 (1.8)
06A6A2□	145.5 (198.5)	115.5 (169.5)	-	-	1.6 (2.2)
08A6A2□	145 (192)	105 (152)	-	-	2.4 (3.0)
10A6A2□	170 (217)	130 (177)	-	-	3.2 (3.8)
15A6A2□	210 (251)	165 (206)	44 (44)	153 (194)	4.6 (6.0)
20A6A2□	226 (267)	181 (222)	44 (44)	169 (210)	5.4 (6.8)
25A6A2□	249 (300)	204 (255)	44 (44)	192 (243)	6.8 (8.7)
30A6A2□	265 (301)	202 (240)	44 (44)	190 (228)	10.5 (13)
40A6A2□	304 (340)	241 (277)	44 (44)	229 (265)	13.5 (16)
50A6A2□	344 (380)	281 (317)	44 (44)	269 (305)	16.5 (19)
70A6A2□	397	334	-	269	18.5

Note: The values in parentheses are for Servomotors with Holding Brakes.

◆ Servomotors with Gears

• Shaft End Specification: Straight

Model SGM7A-	L	LL	Approx. Mass [kg]
A5A6AH1□□	146	104	0.6
A5A6AH2□□	(186.5)	(144.5)	(0.9)
A5A6AHC□□	155	113	0.7
	(195.5)	(153.5)	(1.7)
A5A6AH7□□	186.5	128.5	1.3
	(227)	(169)	(1.6)
01A6AH1□□	158	116	0.7
	(198.5)	(156.5)	(1.0)
01A6AHB□□	198.5	140.5	1.4
01A6AHC□□	(239)	(181)	(1.7)
01A6AH7□□	223	143	2.8
	(263.5)	(183.5)	(3.1)
C2A6AH1□□	170	128	0.8
	(218)	(176)	(1.1)
C2A6AHB□□	210.5	152.5	1.5
	(258.5)	(200.5)	(1.8)
C2A6AHC□□	235	155	2.9
C2A6AH7□□	(283)	(203)	(3.2)
02A6AH1□□	191.5	141.5	1.8
	(232)	(182.5)	(2.4)
02A6AHB□□			1.9
			(2.5)
02A6AHC□□	228.5	148.5	3.7
02A6AH7□□	(269)	(189)	(4.3)
04A6AH1□□	207.5	149.5	2.1
	(248)	(198)	(2.7)
04A6AHB□□	236.5	184.5	4.0
04A6AHC□□	(285)	(205)	(4.6)
04A6AH7□□	330.5	197.5	8.6
	(371)	(238)	(9.2)
06A6AH1□□	266.5	186.5	4.3
	(320.5)	(240.5)	(4.9)
06A6AHB□□			4.5
			(5.1)
06A6AHC□□	352.5	219.5	9.1
06A6AH7□□	(406.5)	(273.5)	(9.7)
08A6AH1□□	263	183	5.0
	(310)	(230)	(5.9)
08A6AHB□□			5.2
			(6.1)
08A6AHC□□	342	209	9.9
08A6AH7□□	(389)	(256)	(10.8)
10A6AH1□□	288	208	6.1
	(335)	(255)	(6.7)
10A6AHB□□	367	234	11.0
10A6AHC□□	(414)	(281)	(11.6)
10A6AH7□□			

• Shaft End Specification: Flange Output

Model SGM7A-	L	Approx. Mass [kg]
A5A6AH10□	119	0.6
A5A6AH20□	(159.5)	(0.9)
A5A6AHC0□	128	
	(168.5)	
A5A6AH70□	149.5	1.2
	(190)	(1.5)
01A6AH10□	131	0.7
	(171.5)	(1.0)
01A6AHB0□	161.5	1.3
01A6AHC0□	(202)	(1.6)
01A6AH70□	170	2.4
	(210.5)	(2.7)
C2A6AH10□	143	0.8
	(191)	(1.1)
C2A6AHB0□	173.5	1.4
	(221.5)	(1.7)
C2A6AHC0□	210.5	2.5
C2A6AH70□	(258.5)	(2.8)
02A6AH10□	162.5	1.7
	(203)	(2.3)
02A6AHB0□		1.8
		(2.4)
02A6AHC0□	175.5	3.3
02A6AH70□	(216)	(3.9)
04A6AH10□	178.5	2.0
	(219)	(2.6)
04A6AHB0□	191.5	3.6
04A6AHC0□	(232)	(4.2)
04A6AH70□	232.5	7.2
	(273)	(7.8)
06A6AH10□	213.5	3.9
	(267.5)	(4.5)
06A6AHB0□		4.1
		(4.7)
06A6AHC0□	254.5	7.7
06A6AH70□	(308.5)	(8.3)
08A6AH10□	210	4.8
	(257)	(5.4)
08A6AHB0□		5.0
		(5.6)
08A6AHC0□	244	8.7
08A6AH70□	(291)	(9.3)
10A6AH10□	235	5.7
	(282)	(6.4)
10A6AHB0□	269	9.6
10A6AHC0□	(316)	(10.2)
10A6AH70□		

Note: The values in parentheses are for Servomotors with Holding Brakes.

Selecting Cables

◆ Cable Configurations

The cables shown below are required to connect a Servomotor to a SERVOPACK.

Encoder Cable of 20 m or Less

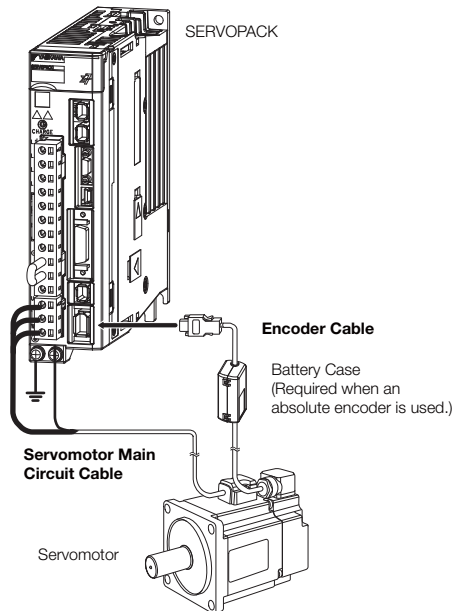

Encoder Cable of 30 m to 50 m (Relay Cable)

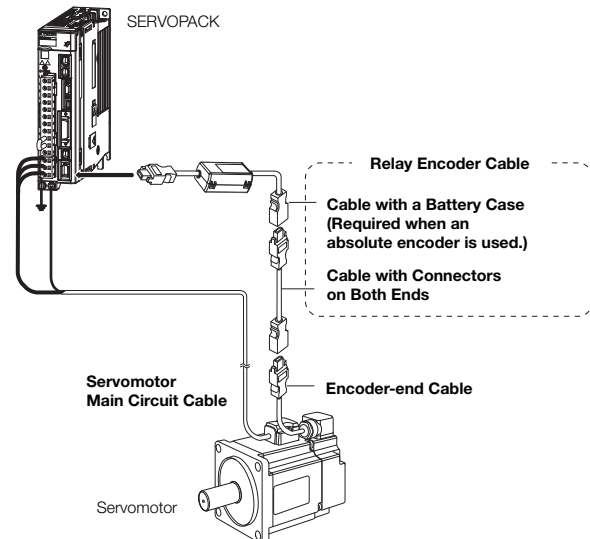

- Note: 1. Cables with connectors on both ends that are compliant with an IP67 protective structure and European Safety Standards are not available from Yaskawa for the SGM7A-15A to SGM7A-70A Servomotors. You must make such a cable yourself. Use the Connectors specified by Yaskawa for these Servomotors. (These Connectors are compliant with the standards.) Yaskawa does not specify what wiring materials to use.
2. If the Encoder Cable length exceeds 20 m, be sure to use a Relay Encoder Cable.
3. If you use a Servomotor Main Circuit Cable that exceeds 20 m, the intermittent duty zone in the torque-motor speed characteristics will become smaller because the voltage drop increases.
4. Refer to the following manual for the following information.
- Cable dimensional drawings and cable connection specifications
 - Order numbers and specifications of individual connectors for cables
 - Order numbers and specifications for wiring materials
- 📖 *Σ-7-Series AC Servo Drive Peripheral Device Selection Manual (Manual No.: SIEP S800001 32)*



For the SGM7A-A5 to -10, there are different order numbers for the Servomotor Main Circuit Cables and Encoder Cables depending on the cable installation direction. Confirm the order numbers before you order.

Cable Installed toward Load

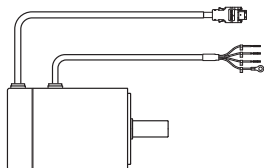

Cable Installed away from Load

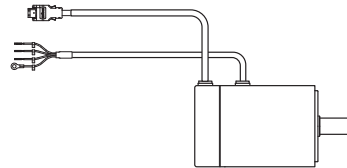

◆ Servomotor Main Circuit Cables

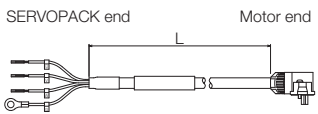
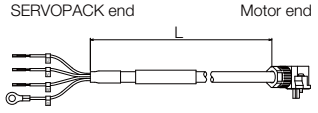
Servomotor Model	Name	Length (L)	Order Number		Appearance	
			Standard Cable	Flexible Cable*		
SGM7A-A5 to -C2 50 W to 150 W	For Servo- motors with- out Holding Brakes	3 m	JZSP-C7M10F-03-E	JZSP-C7M12F-03-E		
		5 m	JZSP-C7M10F-05-E	JZSP-C7M12F-05-E		
		10 m	JZSP-C7M10F-10-E	JZSP-C7M12F-10-E		
		15 m	JZSP-C7M10F-15-E	JZSP-C7M12F-15-E		
		20 m	JZSP-C7M10F-20-E	JZSP-C7M12F-20-E		
		30 m	JZSP-C7M10F-30-E	JZSP-C7M12F-30-E		
		40 m	JZSP-C7M10F-40-E	JZSP-C7M12F-40-E		
50 m		JZSP-C7M10F-50-E	JZSP-C7M12F-50-E			
SGM7A-02 to -06 200 W to 600 W		Cable installed toward load	3 m	JZSP-C7M20F-03-E		JZSP-C7M22F-03-E
			5 m	JZSP-C7M20F-05-E		JZSP-C7M22F-05-E
			10 m	JZSP-C7M20F-10-E		JZSP-C7M22F-10-E
			15 m	JZSP-C7M20F-15-E		JZSP-C7M22F-15-E
			20 m	JZSP-C7M20F-20-E		JZSP-C7M22F-20-E
			30 m	JZSP-C7M20F-30-E		JZSP-C7M22F-30-E
	40 m		JZSP-C7M20F-40-E	JZSP-C7M22F-40-E		
50 m	JZSP-C7M20F-50-E		JZSP-C7M22F-50-E			
SGM7A-08 and -10 750 W, 1.0 kW	Cable installed away from load		3 m	JZSP-C7M30F-03-E	JZSP-C7M32F-03-E	
			5 m	JZSP-C7M30F-05-E	JZSP-C7M32F-05-E	
			10 m	JZSP-C7M30F-10-E	JZSP-C7M32F-10-E	
			15 m	JZSP-C7M30F-15-E	JZSP-C7M32F-15-E	
			20 m	JZSP-C7M30F-20-E	JZSP-C7M32F-20-E	
			30 m	JZSP-C7M30F-30-E	JZSP-C7M32F-30-E	
		40 m	JZSP-C7M30F-40-E	JZSP-C7M32F-40-E		
50 m		JZSP-C7M30F-50-E	JZSP-C7M32F-50-E			
SGM7A-A5 to -C2 50 W to 150 W		For Servo- motors with- out Holding Brakes	3 m	JZSP-C7M10G-03-E	JZSP-C7M12G-03-E	
			5 m	JZSP-C7M10G-05-E	JZSP-C7M12G-05-E	
			10 m	JZSP-C7M10G-10-E	JZSP-C7M12G-10-E	
			15 m	JZSP-C7M10G-15-E	JZSP-C7M12G-15-E	
			20 m	JZSP-C7M10G-20-E	JZSP-C7M12G-20-E	
			30 m	JZSP-C7M10G-30-E	JZSP-C7M12G-30-E	
	40 m		JZSP-C7M10G-40-E	JZSP-C7M12G-40-E		
50 m	JZSP-C7M10G-50-E		JZSP-C7M12G-50-E			
SGM7A-02 to -06 200 W to 600 W	Cable installed away from load		3 m	JZSP-C7M20G-03-E	JZSP-C7M22G-03-E	
			5 m	JZSP-C7M20G-05-E	JZSP-C7M22G-05-E	
			10 m	JZSP-C7M20G-10-E	JZSP-C7M22G-10-E	
			15 m	JZSP-C7M20G-15-E	JZSP-C7M22G-15-E	
			20 m	JZSP-C7M20G-20-E	JZSP-C7M22G-20-E	
			30 m	JZSP-C7M20G-30-E	JZSP-C7M22G-30-E	
		40 m	JZSP-C7M20G-40-E	JZSP-C7M22G-40-E		
50 m		JZSP-C7M20G-50-E	JZSP-C7M22G-50-E			
SGM7A-08 and -10 750 W, 1.0 kW		Cable installed away from load	3 m	JZSP-C7M30G-03-E	JZSP-C7M32G-03-E	
			5 m	JZSP-C7M30G-05-E	JZSP-C7M32G-05-E	
			10 m	JZSP-C7M30G-10-E	JZSP-C7M32G-10-E	
			15 m	JZSP-C7M30G-15-E	JZSP-C7M32G-15-E	
			20 m	JZSP-C7M30G-20-E	JZSP-C7M32G-20-E	
			30 m	JZSP-C7M30G-30-E	JZSP-C7M32G-30-E	
	40 m		JZSP-C7M30G-40-E	JZSP-C7M32G-40-E		
50 m	JZSP-C7M30G-50-E		JZSP-C7M32G-50-E			

* Use Flexible Cables for moving parts of machines, such as robots. The recommended bending radius (R) is 90 mm or larger.

Rotary Servomotors
SGM7A

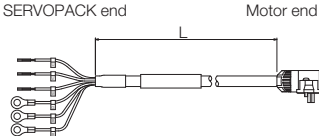
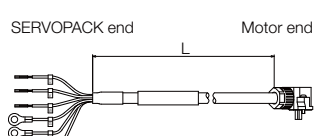
Servomotor Model	Name	Length (L)	Order Number		Appearance
			Standard Cable	Flexible Cable*	
SGM7A-A5 to -C2 50 W to 150 W		3 m	JZSP-C7M13F-03-E	JZSP-C7M14F-03-E	
		5 m	JZSP-C7M13F-05-E	JZSP-C7M14F-05-E	
		10 m	JZSP-C7M13F-10-E	JZSP-C7M14F-10-E	
		15 m	JZSP-C7M13F-15-E	JZSP-C7M14F-15-E	
		20 m	JZSP-C7M13F-20-E	JZSP-C7M14F-20-E	
		30 m	JZSP-C7M13F-30-E	JZSP-C7M14F-30-E	
		40 m	JZSP-C7M13F-40-E	JZSP-C7M14F-40-E	
		50 m	JZSP-C7M13F-50-E	JZSP-C7M14F-50-E	
SGM7A-02 to -06 200 W to 600 W	For Servo- motors with Holding Brakes Cable installed toward load	3 m	JZSP-C7M23F-03-E	JZSP-C7M24F-03-E	
		5 m	JZSP-C7M23F-05-E	JZSP-C7M24F-05-E	
		10 m	JZSP-C7M23F-10-E	JZSP-C7M24F-10-E	
		15 m	JZSP-C7M23F-15-E	JZSP-C7M24F-15-E	
		20 m	JZSP-C7M23F-20-E	JZSP-C7M24F-20-E	
		30 m	JZSP-C7M23F-30-E	JZSP-C7M24F-30-E	
		40 m	JZSP-C7M23F-40-E	JZSP-C7M24F-40-E	
		50 m	JZSP-C7M23F-50-E	JZSP-C7M24F-50-E	
SGM7A-08 and -10 750 W, 1.0 kW		3 m	JZSP-C7M33F-03-E	JZSP-C7M34F-03-E	
		5 m	JZSP-C7M33F-05-E	JZSP-C7M34F-05-E	
		10 m	JZSP-C7M33F-10-E	JZSP-C7M34F-10-E	
		15 m	JZSP-C7M33F-15-E	JZSP-C7M34F-15-E	
		20 m	JZSP-C7M33F-20-E	JZSP-C7M34F-20-E	
		30 m	JZSP-C7M33F-30-E	JZSP-C7M34F-30-E	
		40 m	JZSP-C7M33F-40-E	JZSP-C7M34F-40-E	
		50 m	JZSP-C7M33F-50-E	JZSP-C7M34F-50-E	
SGM7A-A5 to -C2 50 W to 150 W		3 m	JZSP-C7M13G-03-E	JZSP-C7M14G-03-E	
		5 m	JZSP-C7M13G-05-E	JZSP-C7M14G-05-E	
		10 m	JZSP-C7M13G-10-E	JZSP-C7M14G-10-E	
		15 m	JZSP-C7M13G-15-E	JZSP-C7M14G-15-E	
		20 m	JZSP-C7M13G-20-E	JZSP-C7M14G-20-E	
		30 m	JZSP-C7M13G-30-E	JZSP-C7M14G-30-E	
		40 m	JZSP-C7M13G-40-E	JZSP-C7M14G-40-E	
		50 m	JZSP-C7M13G-50-E	JZSP-C7M14G-50-E	
SGM7A-02 to -06 200 W to 600 W	For Servo- motors with Holding Brakes Cable installed away from load	3 m	JZSP-C7M23G-03-E	JZSP-C7M24G-03-E	
		5 m	JZSP-C7M23G-05-E	JZSP-C7M24G-05-E	
		10 m	JZSP-C7M23G-10-E	JZSP-C7M24G-10-E	
		15 m	JZSP-C7M23G-15-E	JZSP-C7M24G-15-E	
		20 m	JZSP-C7M23G-20-E	JZSP-C7M24G-20-E	
		30 m	JZSP-C7M23G-30-E	JZSP-C7M24G-30-E	
		40 m	JZSP-C7M23G-40-E	JZSP-C7M24G-40-E	
		50 m	JZSP-C7M23G-50-E	JZSP-C7M24G-50-E	
SGM7A-08 and -10 750 W, 1.0 kW		3 m	JZSP-C7M33G-03-E	JZSP-C7M34G-03-E	
		5 m	JZSP-C7M33G-05-E	JZSP-C7M34G-05-E	
		10 m	JZSP-C7M33G-10-E	JZSP-C7M34G-10-E	
		15 m	JZSP-C7M33G-15-E	JZSP-C7M34G-15-E	
		20 m	JZSP-C7M33G-20-E	JZSP-C7M34G-20-E	
		30 m	JZSP-C7M33G-30-E	JZSP-C7M34G-30-E	
		40 m	JZSP-C7M33G-40-E	JZSP-C7M34G-40-E	
		50 m	JZSP-C7M33G-50-E	JZSP-C7M34G-50-E	

* Use Flexible Cables for moving parts of machines, such as robots. The recommended bending radius (R) is 90 mm or larger.

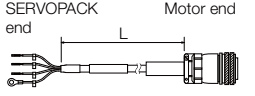
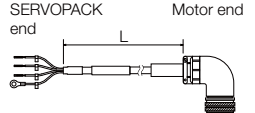
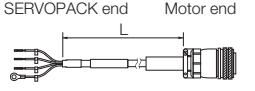
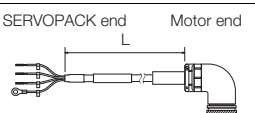
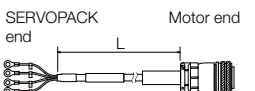
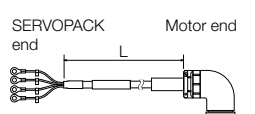
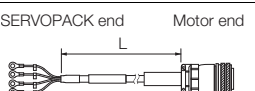
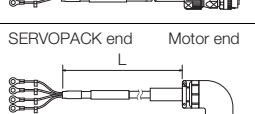
Servo-motor Model	Name	Connector Specifications	Length (L)	Order Number		Appearance
				Standard Cable	Flexible Cable* ¹	
SGM7A-15	For Servomotors without Holding Brakes	Straight	3 m	JZSP-UVA101-03-E	JZSP-UVA121-03-E	
			5 m	JZSP-UVA101-05-E	JZSP-UVA121-05-E	
			10 m	JZSP-UVA101-10-E	JZSP-UVA121-10-E	
			15 m	JZSP-UVA101-15-E	JZSP-UVA121-15-E	
			20 m	JZSP-UVA101-20-E	JZSP-UVA121-20-E	
		Right-angle	3 m	JZSP-UVA102-03-E	JZSP-UVA122-03-E	
			5 m	JZSP-UVA102-05-E	JZSP-UVA122-05-E	
			10 m	JZSP-UVA102-10-E	JZSP-UVA122-10-E	
			15 m	JZSP-UVA102-15-E	JZSP-UVA122-15-E	
			20 m	JZSP-UVA102-20-E	JZSP-UVA122-20-E	
1.5 kW	For Servomotors with Holding Brakes	Straight	3 m	JZSP-UVA131-03-E	JZSP-UVA141-03-E	
			5 m	JZSP-UVA131-05-E	JZSP-UVA141-05-E	
			10 m	JZSP-UVA131-10-E	JZSP-UVA141-10-E	
			15 m	JZSP-UVA131-15-E	JZSP-UVA141-15-E	
			20 m	JZSP-UVA131-20-E	JZSP-UVA141-20-E	
	(Set of Two Cables* ²)	Right-angle	3 m	JZSP-UVA132-03-E	JZSP-UVA142-03-E	
			5 m	JZSP-UVA132-05-E	JZSP-UVA142-05-E	
			10 m	JZSP-UVA132-10-E	JZSP-UVA142-10-E	
			15 m	JZSP-UVA132-15-E	JZSP-UVA142-15-E	
			20 m	JZSP-UVA132-20-E	JZSP-UVA142-20-E	
SGM7A-20	For Servomotors without Holding Brakes	Straight	3 m	JZSP-UVA301-03-E	JZSP-UVA321-03-E	
			5 m	JZSP-UVA301-05-E	JZSP-UVA321-05-E	
			10 m	JZSP-UVA301-10-E	JZSP-UVA321-10-E	
			15 m	JZSP-UVA301-15-E	JZSP-UVA321-15-E	
			20 m	JZSP-UVA301-20-E	JZSP-UVA321-20-E	
		Right-angle	3 m	JZSP-UVA302-03-E	JZSP-UVA322-03-E	
			5 m	JZSP-UVA302-05-E	JZSP-UVA322-05-E	
			10 m	JZSP-UVA302-10-E	JZSP-UVA322-10-E	
			15 m	JZSP-UVA302-15-E	JZSP-UVA322-15-E	
			20 m	JZSP-UVA302-20-E	JZSP-UVA322-20-E	
2.0 kW	For Servomotors with Holding Brakes	Straight	3 m	JZSP-UVA331-03-E	JZSP-UVA341-03-E	
			5 m	JZSP-UVA331-05-E	JZSP-UVA341-05-E	
			10 m	JZSP-UVA331-10-E	JZSP-UVA341-10-E	
			15 m	JZSP-UVA331-15-E	JZSP-UVA341-15-E	
			20 m	JZSP-UVA331-20-E	JZSP-UVA341-20-E	
	(Set of Two Cables* ²)	Right-angle	3 m	JZSP-UVA332-03-E	JZSP-UVA342-03-E	
			5 m	JZSP-UVA332-05-E	JZSP-UVA342-05-E	
			10 m	JZSP-UVA332-10-E	JZSP-UVA342-10-E	
			15 m	JZSP-UVA332-15-E	JZSP-UVA342-15-E	
			20 m	JZSP-UVA332-20-E	JZSP-UVA342-20-E	

*1. Use Flexible Cables for moving parts of machines, such as robots. The recommended bending radius (R) is 90 mm or larger.

*2. This order number is for a set of two cables (Main Power Supply Cable and Holding Brake Cable). When you purchase them separately, the order numbers for Main Power Supply Cables are the same as for a Servomotor without a Holding Brake.

The following order numbers are for a Holding Brake Cable. These Standard Cables are Flexible Cables.

- Cable with Straight Plug: JZSP-U7B23-□□-E
- Cable with Right-angle Plug: JZSP-U7B24-□□-E

Rotary Servomotors
SGM7A

Servo-motor Model	Name	Connector Specifications	Length (L)	Order Number		Appearance
				Standard Cable	Flexible Cable* ¹	
SGM7A-25 2.5 kW	For Servomotors without Holding Brakes	Straight	3 m	JZSP-UVA501-03-E	JZSP-UVA521-03-E	
			5 m	JZSP-UVA501-05-E	JZSP-UVA521-05-E	
			10 m	JZSP-UVA501-10-E	JZSP-UVA521-10-E	
			15 m	JZSP-UVA501-15-E	JZSP-UVA521-15-E	
		Right-angle	3 m	JZSP-UVA502-03-E	JZSP-UVA522-03-E	
			5 m	JZSP-UVA502-05-E	JZSP-UVA522-05-E	
			10 m	JZSP-UVA502-10-E	JZSP-UVA522-10-E	
			15 m	JZSP-UVA502-15-E	JZSP-UVA522-15-E	
	For Servomotors with Holding Brakes (Set of Two Cables* ²)	Straight	3 m	JZSP-U7A551-03-E	JZSP-U7A561-03-E	
			5 m	JZSP-U7A551-05-E	JZSP-U7A561-05-E	
			10 m	JZSP-U7A551-10-E	JZSP-U7A561-10-E	
			15 m	JZSP-U7A551-15-E	JZSP-U7A561-15-E	
		Right-angle	3 m	JZSP-U7A552-03-E	JZSP-U7A562-03-E	
			5 m	JZSP-U7A552-05-E	JZSP-U7A562-05-E	
			10 m	JZSP-U7A552-10-E	JZSP-U7A562-10-E	
			15 m	JZSP-U7A552-15-E	JZSP-U7A562-15-E	
SGM7A-30 3.0 kW	For Servomotors without Holding Brakes	Straight	3 m	JZSP-UVA601-03-E	JZSP-UVA621-03-E	
			5 m	JZSP-UVA601-05-E	JZSP-UVA621-05-E	
			10 m	JZSP-UVA601-10-E	JZSP-UVA621-10-E	
			15 m	JZSP-UVA601-15-E	JZSP-UVA621-15-E	
		Right-angle	3 m	JZSP-UVA602-03-E	JZSP-UVA622-03-E	
			5 m	JZSP-UVA602-05-E	JZSP-UVA622-05-E	
			10 m	JZSP-UVA602-10-E	JZSP-UVA622-10-E	
			15 m	JZSP-UVA602-15-E	JZSP-UVA622-15-E	
	For Servomotors with Holding Brakes (Set of Two Cables* ²)	Straight	3 m	JZSP-UVA631-03-E	JZSP-UVA641-03-E	
			5 m	JZSP-UVA631-05-E	JZSP-UVA641-05-E	
			10 m	JZSP-UVA631-10-E	JZSP-UVA641-10-E	
			15 m	JZSP-UVA631-15-E	JZSP-UVA641-15-E	
		Right-angle	3 m	JZSP-UVA632-03-E	JZSP-UVA642-03-E	
			5 m	JZSP-UVA632-05-E	JZSP-UVA642-05-E	
			10 m	JZSP-UVA632-10-E	JZSP-UVA642-10-E	
			15 m	JZSP-UVA632-15-E	JZSP-UVA642-15-E	

*1. Use Flexible Cables for moving parts of machines, such as robots. The recommended bending radius (R) is 90 mm or larger.

*2. This order number is for a set of two cables (Main Power Supply Cable and Holding Brake Cable).
When you purchase them separately, the order numbers for Main Power Supply Cables are the same as for a Servomotor without a Holding Brake.
The following order numbers are for a Holding Brake Cable. These Standard Cables are Flexible Cables.

- Cable with Straight Plug: JZSP-U7B23-□□-E
- Cable with Right-angle Plug: JZSP-U7B24-□□-E

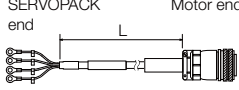
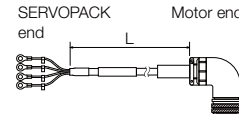
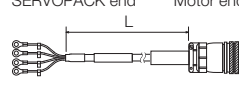
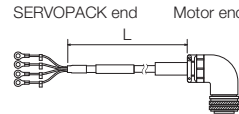
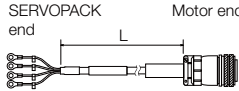
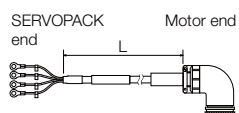
Servo-motor Model	Name	Connector Specifications	Length (L)	Order Number		Appearance
				Standard Cable	Flexible Cable* ¹	
SGM7A-40 and -50	For Servomotors without Holding Brakes	Straight	3 m	JZSP-UVA701-03-E	JZSP-UVA721-03-E	
			5 m	JZSP-UVA701-05-E	JZSP-UVA721-05-E	
			10 m	JZSP-UVA701-10-E	JZSP-UVA721-10-E	
			15 m	JZSP-UVA701-15-E	JZSP-UVA721-15-E	
			20 m	JZSP-UVA701-20-E	JZSP-UVA721-20-E	
		Right-angle	3 m	JZSP-UVA702-03-E	JZSP-UVA722-03-E	
			5 m	JZSP-UVA702-05-E	JZSP-UVA722-05-E	
			10 m	JZSP-UVA702-10-E	JZSP-UVA722-10-E	
			15 m	JZSP-UVA702-15-E	JZSP-UVA722-15-E	
			20 m	JZSP-UVA702-20-E	JZSP-UVA722-20-E	
4.0 kW, 5.0 kW	For Servomotors with Holding Brakes	Straight	3 m	JZSP-UVA731-03-E	JZSP-UVA741-03-E	
			5 m	JZSP-UVA731-05-E	JZSP-UVA741-05-E	
			10 m	JZSP-UVA731-10-E	JZSP-UVA741-10-E	
			15 m	JZSP-UVA731-15-E	JZSP-UVA741-15-E	
			20 m	JZSP-UVA731-20-E	JZSP-UVA741-20-E	
	(Set of Two Cables* ²)	Right-angle	3 m	JZSP-UVA732-03-E	JZSP-UVA742-03-E	
			5 m	JZSP-UVA732-05-E	JZSP-UVA742-05-E	
			10 m	JZSP-UVA732-10-E	JZSP-UVA742-10-E	
			15 m	JZSP-UVA732-15-E	JZSP-UVA742-15-E	
			20 m	JZSP-UVA732-20-E	JZSP-UVA742-20-E	
SGM7A-70* ³	For Servomotors without Holding Brakes	Straight	3 m	JZSP-UVA901-03-E	JZSP-UVA921-03-E	
			5 m	JZSP-UVA901-05-E	JZSP-UVA921-05-E	
			10 m	JZSP-UVA901-10-E	JZSP-UVA921-10-E	
			15 m	JZSP-UVA901-15-E	JZSP-UVA921-15-E	
			20 m	JZSP-UVA901-20-E	JZSP-UVA921-20-E	
		Right-angle	3 m	JZSP-UVA902-03-E	JZSP-UVA922-03-E	
			5 m	JZSP-UVA902-05-E	JZSP-UVA922-05-E	
			10 m	JZSP-UVA902-10-E	JZSP-UVA922-10-E	
			15 m	JZSP-UVA902-15-E	JZSP-UVA922-15-E	
			20 m	JZSP-UVA902-20-E	JZSP-UVA922-20-E	

*1. Use Flexible Cables for moving parts of machines, such as robots. The recommended bending radius (R) is 90 mm or larger.

*2. This order number is for a set of two cables (Main Power Supply Cable and Holding Brake Cable). When you purchase them separately, the order numbers for Main Power Supply Cables are the same as for a Servomotor without a Holding Brake.

The following order numbers are for a Holding Brake Cable. These Standard Cables are Flexible Cables.

- Cable with Straight Plug: JZSP-U7B23-□□-E
- Cable with Right-angle Plug: JZSP-U7B24-□□-E

*3. A cooling fan is built into the SGM7A-70 Servomotor. There is no specified cable to connect to the built-in cooling fan connector. Use appropriate wiring materials for the built-in cooling fan connector specifications. The cable is available from Yaskawa Controls Co., Ltd. Refer to the following manual for the built-in cooling fan connector specifications that are required to select the cable.

 *Σ-7-Series AC Servo Drive Peripheral Device Selection Manual (Manual No.: SIEP S80001 32)*

◆ Encoder Cables of 20 m or Less

Servomotor Model	Name	Length (L)	Order Number		Appearance				
			Standard Cable	Flexible Cable*1					
SGM7A-A5 to -10 50 W to 1.0 kW	For incremental encoder, or batteryless absolute encoder	3 m	JZSP-C7PI0D-03-E	JZSP-C7PI2D-03-E					
		5 m	JZSP-C7PI0D-05-E	JZSP-C7PI2D-05-E					
		10 m	JZSP-C7PI0D-10-E	JZSP-C7PI2D-10-E					
		15 m	JZSP-C7PI0D-15-E	JZSP-C7PI2D-15-E					
		20 m	JZSP-C7PI0D-20-E	JZSP-C7PI2D-20-E					
	Cable installed toward load	For incremental encoder, or batteryless absolute encoder	3 m	JZSP-C7PI0E-03-E	JZSP-C7PI2E-03-E				
			5 m	JZSP-C7PI0E-05-E	JZSP-C7PI2E-05-E				
			10 m	JZSP-C7PI0E-10-E	JZSP-C7PI2E-10-E				
			15 m	JZSP-C7PI0E-15-E	JZSP-C7PI2E-15-E				
			20 m	JZSP-C7PI0E-20-E	JZSP-C7PI2E-20-E				
	Cable installed away from load	For absolute encoder: With Battery Case*2	3 m	JZSP-C7PA0D-03-E	JZSP-C7PA2D-03-E				
			5 m	JZSP-C7PA0D-05-E	JZSP-C7PA2D-05-E				
			10 m	JZSP-C7PA0D-10-E	JZSP-C7PA2D-10-E				
			15 m	JZSP-C7PA0D-15-E	JZSP-C7PA2D-15-E				
			20 m	JZSP-C7PA0D-20-E	JZSP-C7PA2D-20-E				
	Cable installed toward load	For absolute encoder: With Battery Case*2	3 m	JZSP-C7PA0E-03-E	JZSP-C7PA2E-03-E				
			5 m	JZSP-C7PA0E-05-E	JZSP-C7PA2E-05-E				
			10 m	JZSP-C7PA0E-10-E	JZSP-C7PA2E-10-E				
			15 m	JZSP-C7PA0E-15-E	JZSP-C7PA2E-15-E				
			20 m	JZSP-C7PA0E-20-E	JZSP-C7PA2E-20-E				
SGM7A-15 to -70 1.5 kW to 7.0 kW	For incremental encoder, or batteryless absolute encoder	3 m	JZSP-CVP01-03-E	JZSP-CVP11-03-E					
		5 m	JZSP-CVP01-05-E	JZSP-CVP11-05-E					
		10 m	JZSP-CVP01-10-E	JZSP-CVP11-10-E					
		15 m	JZSP-CVP01-15-E	JZSP-CVP11-15-E					
		20 m	JZSP-CVP01-20-E	JZSP-CVP11-20-E					
		Cable installed toward load	For incremental encoder, or batteryless absolute encoder	3 m		JZSP-CVP02-03-E*3	JZSP-CVP12-03-E		
				5 m		JZSP-CVP02-05-E*3	JZSP-CVP12-05-E		
				10 m		JZSP-CVP02-10-E*3	JZSP-CVP12-10-E		
				15 m		JZSP-CVP02-15-E*3	JZSP-CVP12-15-E		
				20 m		JZSP-CVP02-20-E*3	JZSP-CVP12-20-E		
	Cable installed away from load			For absolute encoder: With Battery Case*2	3 m	JZSP-CVP06-03-E	JZSP-CVP26-03-E		
					5 m	JZSP-CVP06-05-E	JZSP-CVP26-05-E		
					10 m	JZSP-CVP06-10-E	JZSP-CVP26-10-E		
		15 m	JZSP-CVP06-15-E		JZSP-CVP26-15-E				
		20 m	JZSP-CVP06-20-E		JZSP-CVP26-20-E				
		Cable installed toward load	For absolute encoder: With Battery Case*2		3 m	JZSP-CVP07-03-E*3	JZSP-CVP27-03-E		
					5 m	JZSP-CVP07-05-E*3	JZSP-CVP27-05-E		
					10 m	JZSP-CVP07-10-E*3	JZSP-CVP27-10-E		
					15 m	JZSP-CVP07-15-E*3	JZSP-CVP27-15-E		
					20 m	JZSP-CVP07-20-E*3	JZSP-CVP27-20-E		

*1. Use Flexible Cables for moving parts of machines, such as robots. The recommended bending radius (R) is 90 mm or larger.

*2. If a battery is connected to the host controller, the Battery Case is not required. If so, use a cable for incremental encoders.

*3. You cannot use a right-angle connector for the encoder of a SGM7A-70A (7.0 kW) Servomotor. Use a straight connector.

◆ Relay Encoder Cable of 30 m to 50 m

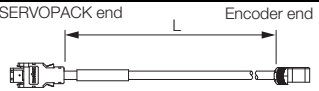
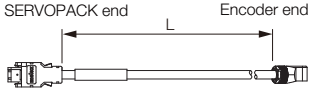
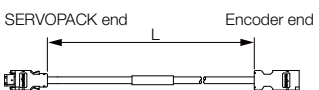
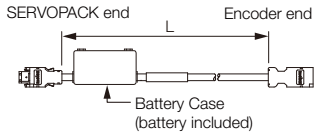
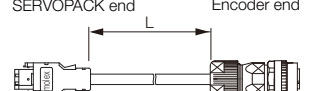
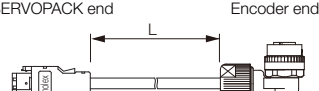
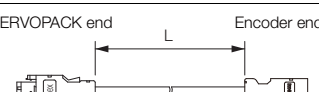
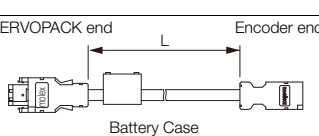
Servomotor Model	Name	Length (L)	Order Number	Appearance
SGM7A-A5 to -10 50 W to 1.0 kW	Encoder-end Cable (for all types of encoders) Cable installed toward load	0.3 m	JZSP-C7PRCD-E	
	Encoder-end Cable (for all types of encoders) Cable installed away from load	0.3 m	JZSP-C7PRCE-E	
	Cables with Connectors on Both Ends (for all types of encoders)	30 m	JZSP-UCMP00-30-E	
		40 m	JZSP-UCMP00-40-E	
50 m		JZSP-UCMP00-50-E		
	Cable with a Battery Case (Required when an absolute encoder is used. *2)	0.3 m	JZSP-CSP12-E	
SGM7A-15 to -70 1.5 kW to 7.0 kW	Encoder-end Cable (for all types of encoders)	0.3 m	JZSP-CVP01-E	
			JZSP-CVP02-E*1	
	Cables with Connectors on Both Ends (for all types of encoders)	30 m	JZSP-UCMP00-30-E	
			JZSP-UCMP00-40-E	
JZSP-UCMP00-50-E				
	Cable with a Battery Case (Required when an absolute encoder is used. *2)	0.3 m	JZSP-CSP12-E	

*1. You cannot use a right-angle connector for the encoder of a SGM7A-70A (7.0 kW) Servomotor.
Use a straight connector.

*2. This Cable is not required if you use a Servomotor with a Batteryless Absolute Encoder, and you connect a battery to the host controller.

SGM7P

Model Designations

Without Gears

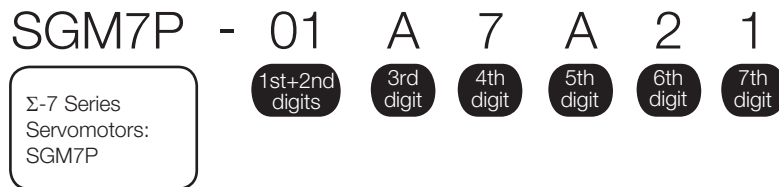

1st+2nd digits Rated Output

Code	Specification
01	100 W
02	200 W
04	400 W
08	750 W
15	1.5 kW

3rd digit Power Supply Voltage

Code	Specification
A	200 VAC

4th digit Serial Encoder

Code	Specification
6	24-bit batteryless absolute
7	24-bit absolute
F	24-bit incremental

5th digit Design Revision Order

Code	Specification
A	IP65
E	IP67

6th digit Shaft End

Code	Specification
2	Straight without key
6	Straight with key and tap

7th digit Options

Code	Specification
1	Without options
C	With holding brake (24 VDC)
E	With oil seal and holding brake (24 VDC)
S	With oil seal

With Gears



1st+2nd digits Rated Output

Code	Specification
01	100 W
02	200 W
04	400 W
08	750 W
15	1.5 kW

3rd digit Power Supply Voltage

Code	Specification
A	200 VAC

4th digit Serial Encoder

Code	Specification
6	24-bit batteryless absolute
7	24-bit absolute
F	24-bit incremental

5th digit Design Revision Order

Code	Specification
A	IP55

6th digit Gear Type

Code	Specification
H	HDS planetary low-backlash gear

7th digit Gear Ratio

Code	Specification
B	1/11
C	1/21
1	1/5
7	1/33

8th digit Shaft End

Code	Specification
0	Flange output
2	Straight without key
6	Straight with key and tap

9th digit Options

Code	Specification
1	Without options
C	With holding brake (24 VDC)

Specifications and Ratings

Specifications

Voltage		200 V				
Model SGM7P-		01A	02A	04A	08A	15A
Time Rating		Continuous				
Thermal Class		UL: B, CE: B				
Insulation Resistance		500 VDC, 10 MΩ min.				
Withstand Voltage		1,500 VAC for 1 minute				
Excitation		Permanent magnet				
Mounting		Flange-mounted				
Drive Method		Direct drive				
Rotation Direction		Counterclockwise (CCW) for forward reference when viewed from the load side				
Vibration Class* ¹		V15				
Environmental Conditions	Surrounding Air Temperature	0°C to 40°C (With derating, usage is possible between 40°C and 60°C.)* ³				
	Surrounding Air Humidity	20% to 80% relative humidity (with no condensation)				
	Installation Site	<ul style="list-style-type: none"> • Must be indoors and free of corrosive and explosive gases. • Must be well-ventilated and free of dust and moisture. • Must facilitate inspection and cleaning. • Must have an altitude of 1,000 m or less. (With derating, usage is possible between 1,000 m and 2,000 m.)*³ • Must be free of strong magnetic fields. 				
	Storage Environment	Store the Servomotor in the following environment if you store it with the power cable disconnected. Storage Temperature: -20°C to 60°C (with no freezing) Storage Humidity: 20% to 80% relative humidity (with no condensation)				
Shock Resistance* ²	Impact Acceleration Rate at Flange	490 m/s ²				
	Number of Impacts	2 times				
Vibration Resistance* ²	Vibration Acceleration Rate at Flange	49 m/s ²				
Applicable SERVOPACKs	SGD7S-	R90A, R90F	2R8A, 2R1F	2R8A, 2R8F	5R5A	120A
	SGD7W- SGD7C-	1R6A* ⁴ , 2R8A* ⁴	2R8A, 5R5A* ⁴ , 7R6A* ⁴		5R5A, 7R6A	—

*1. A vibration class of V15 indicates a vibration amplitude of 15 μm maximum on the Servomotor without a load at the rated motor speed.

*2. The given values are for when the Servomotor shaft is mounted horizontally and shock or vibration is applied in the directions shown in the following figures.

The strength of the vibration that the Servomotor can withstand depends on the application. Always check the vibration acceleration rate that is applied to the Servomotor with the actual equipment.

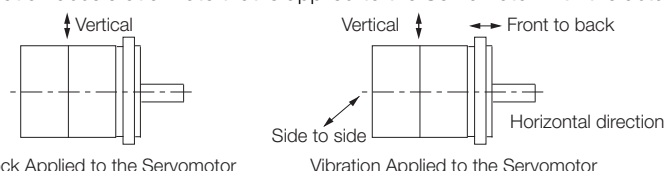

*3. Refer to the following section for the derating rates.

Derating Rates (page 82)

*4. If you use a Servomotor together with a Σ-7W or Σ-7C SERVOPACK, the control gain may not increase as much as with a Σ-7S SERVOPACK and other performances may be lower than those achieved with a Σ-7S SERVOPACK.

Ratings of Servomotors without Gears

Voltage		200 V					
Model SGM7P-		01A	02A	04A	08A	15A	
Rated Output* ¹	W	100	200	400	750	1500	
Rated Torque* ^{1, *2}	N·m	0.318	0.637	1.27	2.39	4.77	
Instantaneous Maximum Torque* ¹	N·m	0.955	1.91	3.82	7.16	14.3	
Rated Current* ¹	Arms	0.86	2.0	2.6	5.4	9.2	
Instantaneous Maximum Current* ¹	Arms	2.8	6.4	8.4	16.5	28.0	
Rated Motor Speed* ¹	min ⁻¹	3000					
Maximum Motor Speed* ¹	min ⁻¹	6000					
Torque Constant	N·m/Arms	0.401	0.355	0.524	0.476	0.559	
Motor Moment of Inertia	×10 ⁻⁴ kg·m ²	0.0592	0.263	0.409	2.10	4.02	
With holding brake		0.0892	0.415	0.561	2.98	4.90	
With batteryless absolute encoder		0.0607	0.264	0.410	2.10	4.02	
Rated Power Rate* ¹	kW/s	17.1	15.4	39.6	27.2	56.6	
With holding brake		11.3	9.7	28.8	19.1	46.4	
Rated Angular Acceleration Rate* ¹	rad/s ²	53700	24200	31100	11400	11900	
With holding brake		35600	15300	22600	8020	9730	
Derating Rate for Servomotor with Oil Seal	%	90		95			
Heat Sink Size* ³	mm	250 × 250 × 6			300 × 300 × 12		
Protective Structure* ⁴	Totally enclosed, self-cooled, IP65						
Holding Brake Specifications* ⁵	Rated Voltage	V	24 VDC ±10%				
	Capacity	W	6	7.4	7.5		
	Holding Torque	N·m	0.318	0.637	1.27	2.39	4.77
	Coil Resistance	Ω (at 20°C)	96	84.5		76.8	
	Rated Current	A (at 20°C)	0.25	0.31		0.31	
	Time Required to Release Brake	ms	80				
	Time Required to Brake	ms	100				
Allowable Load Moment of Inertia (Motor Moment of Inertia Ratio)* ⁶			25 times	15 times	10 times	5 times	
	With External Regenerative Resistor and External Dynamic Brake Resistor* ⁷						
Allowable Shaft Loads* ⁸	LF	mm	20	25		35	
	Allowable Radial Load	N	78	245		392	490
	Allowable Thrust Load	N	49	68		147	

*1. These values are for operation in combination with a SERVOPACK when the temperature of the armature winding is 100°C. The values for other items are at 20°C. These are typical values.

*2. The rated torques are the continuous allowable torque values at a surrounding air temperature of 40°C with an aluminum heat sink of the dimensions given in the table.

*3. Refer to the following section for the relation between the heat sinks and derating rate.

 **Servomotor Heat Dissipation Conditions (page 82)**

*4. This does not apply to the shaft opening. Protective structure specifications apply only when the special cable is used.

*5. Observe the following precautions if you use a Servomotor with a Holding Brake.

- The holding brake cannot be used to stop the Servomotor.
- The time required to release the brake and the time required to brake depend on which discharge circuit is used. Confirm that the operation delay time is appropriate for the actual equipment.
- The 24-VDC power supply is not provided by Yaskawa.

*6. The motor moment of inertia scaling factor is the value for a standard Servomotor without a Holding Brake.

*7. To externally connect a dynamic brake resistor, select hardware option specification 020 for the SERVOPACK.

However, you cannot externally connect a dynamic brake resistor if you use the following SERVOPACKS

(maximum applicable motor capacity: 400 W).

- SGD7S-R70□□□A020 to -2R8□□□A020
- SGD7W-1R6A20A020 to -2R8A20A020
- SGD7C-1R6AMAA020 to -2R8AMAA020

*8. Design the mechanical system so that the thrust and radial loads applied to the Servomotor shaft end during operation do not exceed the values given in the table.

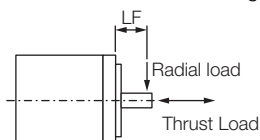

Ratings of Servomotors with Gears

All Models	Gear Mechanism				Protective Structure			Lost Motion [arc-min]		
	Planetary gear mechanism				Totally enclosed, self-cooled, IP55 (except for shaft opening)			3 max.		
Servomotor Model SGM7P-	Servomotor					Gear Output				
	Rated Output [W]	Rated Motor Speed [min ⁻¹]	Maximum Motor Speed [min ⁻¹]	Rated Torque [N·m]	Instantaneous Maximum Torque [N·m]	Gear Ratio	Rated Torque/Efficiency* ¹ [N·m/%]	Instantaneous Maximum Torque [N·m]	Rated Motor Speed [min ⁻¹]	Maximum Motor Speed [min ⁻¹]
01A□AH1□	100	3000	6000	0.318	0.955	1/5	1.05/78* ²	4.30	600	1200
01A□AHB□						1/11	2.52/72	9.30	273	545
01A□AHC□						1/21	5.34/80	18.2	143	286
01A□AH7□						1/33	6.82/65	27.0	91	182
02A□AH1□	200	3000	6000	0.637	1.91	1/5	2.39/75	8.60	600	1200
02A□AHB□						1/11	5.74/82	19.4	273	545
02A□AHC□						1/21	10.2/76	35.9	143	286
02A□AH7□						1/33	17.0/81	57.3	91	182
04A□AH1□	400	3000	6000	1.27	3.82	1/5	5.33/84	17.8	600	1200
04A□AHB□						1/11	11.5/82	38.3	273	545
04A□AHC□						1/21	22.9/86	74.4	143	286
04A□AH7□						1/33	34.0/81	114.6	91	182
08A□AH1□	750	3000	6000	2.39	7.16	1/5	10.0/84	32.8	600	1200
08A□AHB□						1/11	23.1/88	73.6	273	545
08A□AHC□						1/21	42.1/84	138.0	143	286
08A□AH7□						1/33	69.3/88	220	91	182
15A□AH1□	1500	3000	6000	4.77	14.3	1/5	19.1/80	64.8	600	1200
15A□AHB□						1/11	45.6/87	146	273	545
15A□AHC□						1/21	87.1/87	278	143	214* ³
15A□AH7□						1/33	142/90	443	91	136* ³

*1. The gear output torque is expressed by the following formula.

$$\text{Gear output torque} = \text{Servomotor output torque} \times \frac{1}{\text{Gear ratio}} \times \text{Efficiency}$$

The gear efficiency depends on operating conditions such as the output torque, motor speed, and temperature. The values in the table are typical values for the rated torque, rated motor speed, and a surrounding air temperature of 25°C. They are reference values only.

*2. Use the Servomotor at an effective load ratio of 85% or less. The values in the table take the effective load ratio into consideration.

*3. The maximum motor speed calculated at the motor shaft is 4,500 min⁻¹ max.

Note: 1. The gears that are mounted to Yaskawa Servomotors have not been broken in.

Break in the Servomotor if necessary. First, operate the Servomotor at low speed with no load. If no problems occur, gradually increase the speed and load.

2. The no-load torque for a Servomotor with a Gear is high immediately after the Servomotor starts, and it then decreases and becomes stable after a few minutes. This is a common phenomenon caused by grease circulation in the gears and it does not indicate faulty gears.

3. Other specifications are the same as those for Servomotors without Gears.



Important

The SERVOPACK speed control range is 1:5,000. If you use Servomotors at extremely low speeds (0.02 min⁻¹ or lower at the gear output shaft), if you use Servomotors with a one-pulse feed reference for extended periods, or under some other operating conditions, the gear bearing lubrication may be insufficient. That may cause deterioration of the bearing or increase the load ratio. Contact your Yaskawa representative if you use a Servomotor under these conditions.

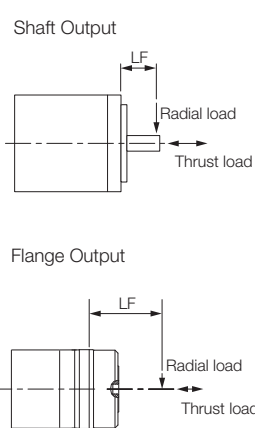
Servomotor Model SGM7P-	Moment of Inertia [$\times 10^{-4}$ kg·m ²]				With Low-Backlash Gears			Reference Diagram
	Shaft Output		Flange Output		Allowable Radial Load [N]	Allowable Thrust Load [N]	LF [mm]	
	Motor* + Gear	Gear	Motor* + Gear	Gear				
01A□AH1□	0.0642	0.005	0.0632	0.004	95	431	37	
01A□AHB□	0.119	0.060	0.118	0.059	192	895	53	
01A□AHC□	0.109	0.050	0.109	0.050	233	1087	53	
01A□AH7□	0.509	0.450	0.508	0.449	605	2581	75	
02A□AH1□	0.470	0.207	0.464	0.201	152	707	53	
02A□AHB□	0.456	0.193	0.455	0.192	192	895	53	
02A□AHC□	0.753	0.490	0.751	0.488	528	2254	75	
02A□AH7□	0.713	0.450	0.712	0.449	605	2581	75	
04A□AH1□	0.616	0.207	0.610	0.201	152	707	53	
04A□AHB□	0.979	0.570	0.969	0.560	435	1856	75	
04A□AHC□	0.899	0.490	0.897	0.488	528	2254	75	
04A□AH7□	1.03	0.620	1.01	0.610	951	4992	128	
08A□AH1□	3.20	1.10	3.16	1.06	343	1465	75	
08A□AHB□	2.70	0.600	2.69	0.590	435	1856	75	
08A□AHC□	5.10	3.00	5.08	2.98	830	4359	128	
08A□AH7□	4.90	2.80	4.89	2.79	951	4992	128	
15A□AH1□	7.82	3.80	7.55	3.53	540	2834	128	
15A□AHB□	7.42	3.40	7.36	3.34	684	3590	128	
15A□AHC□	9.82	5.80	9.72	5.70	2042	8840	151	
15A□AH7□	8.82	4.80	8.79	4.77	2338	10120	151	

* The moment of inertia for the Servomotor and gear is the value without a holding brake. You can calculate the moment of inertia for a Servomotor with a Gear and Holding Brake with the following formula.
 Motor moment of inertia for a Servomotor with a Holding Brake from *Ratings of Servomotors without Gears* (page 76) + Moment of inertia for the gear from the above table.



Important

During operation, the gear generates the loss at the gear mechanism and oil seal. The loss depends on the torque and motor speed conditions. The temperature rise depends on the loss and heat dissipation conditions. For the heat dissipation conditions, always refer to the following table and check the gear and motor temperatures with the actual equipment. If the temperature is too high, implement the following measures.

- Decrease the load ratio.
- Change the heat dissipation conditions.
- Use forced-air cooling for the motor with a cooling fan or other means.

Model	Heat Sink Size			
	1/5	1/11	1/21	1/33
SGM7P-01	C		A	
SGM7P-02			A	
SGM7P-04	C		B	
SGM7P-08			B	
SGM7P-15			B	

- A: 250 mm × 250 mm × 6 mm, aluminum plate
- B: 300 mm × 300 mm × 12 mm, aluminum plate
- C: 350 mm × 350 mm × 12 mm, aluminum plate

Servomotor Overload Protection Characteristics

The overload detection level is set for hot start conditions with a Servomotor surrounding air temperature of 40°C.

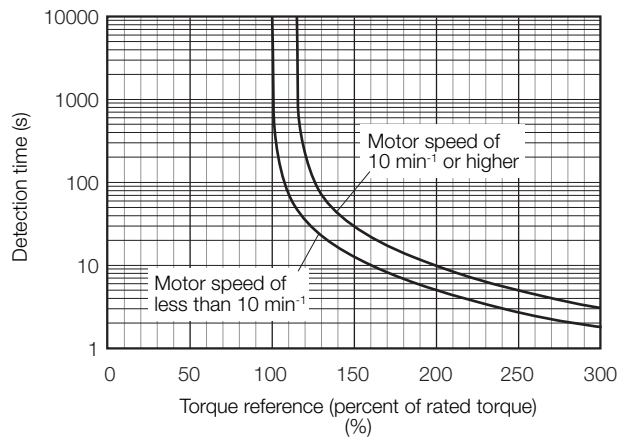

Note: The above overload protection characteristics do not mean that you can perform continuous duty operation with an output of 100% or higher. Use the Servomotor so that the effective torque remains within the continuous duty zone given in *Torque-Motor Speed Characteristics* (page 77).

Allowable Load Moment of Inertia

The allowable load moments of inertia (motor moment of inertia ratios) for the Servomotors are given in the *Ratings of Servomotors without Gears* (page 76). The values are determined by the regenerative energy processing capacity of the SERVOPACK and are also affected by the drive conditions of the Servomotor. Perform the required Steps for each of the following cases.

Use the SigmaSize+ AC Servo Drive Capacity Selection Program to check the driving conditions. Contact your Yaskawa representative for information on this program.

◆ Exceeding the Allowable Load Moment of Inertia

Use one of the following measures to adjust the load moment of inertia to within the allowable value.

- Reduce the torque limit.
- Reduce the deceleration rate.
- Reduce the maximum motor speed.

If the above steps is not possible, install an external regenerative resistor.

Information

An Overvoltage Alarm (A.400) is likely to occur during deceleration if the load moment of inertia exceeds the allowable load moment of inertia. SERVOPACKs with a built-in regenerative resistor may generate a Regenerative Overload Alarm (A.320). Refer to *Built-In Regenerative Resistor* (page 472) for the regenerative power (W) that can be processed by the SERVOPACKs.

Install an External Regenerative Resistor when the built-in regenerative resistor cannot process all of the regenerative power.

◆ SERVOPACKs without Built-in Regenerative Resistors

The following graph shows the allowable load moment of inertia scaling factor of the motor speed (reference values for deceleration operation at or above the rated torque). Application is possible without an external regenerative resistor within the allowable value. However, an External Regenerative Resistor is required in the shaded areas of the graphs.

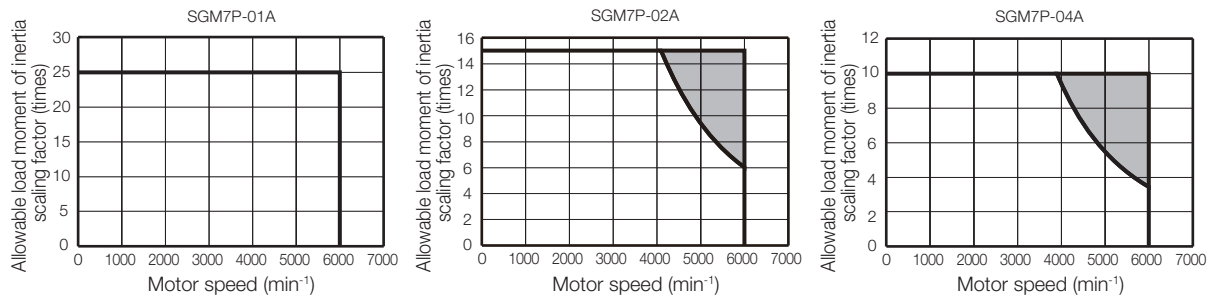

Note: Applicable SERVOPACK models: SGD7S-R70A, -R90A, -1R6A, -2R8A, -R70F, -R90F, -2R1F, and -2R8F

◆ When an External Regenerative Resistor Is Required

Install the External Regenerative Resistor. Refer to the following section for the recommended products.

[External Regenerative Resistors](#) (page 472)

Derating Rates

◆ Servomotor Heat Dissipation Conditions

The Servomotor ratings are the continuous allowable values at a surrounding air temperature of 40°C when a heat sink is installed on the Servomotor. If the Servomotor is mounted on a small device component, the Servomotor temperature may rise considerably because the surface for heat dissipation becomes smaller. Refer to the following graphs for the relation between the heat sink size and derating rate.

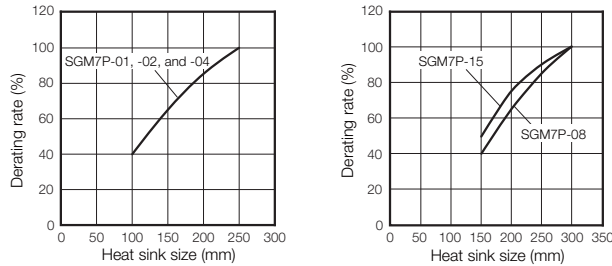

Important

The actual temperature rise depends on how the heat sink (i.e., the Servomotor mounting section) is attached to the installation surface, what material is used for the Servomotor mounting section, and the motor speed. Always check the Servomotor temperature with the actual equipment.

◆ Applications Where the Surrounding Air Temperature Exceeds 40°C

The Servomotor ratings are the continuous allowable values at a surrounding air temperature of 40°C. If you use a Servomotor at a surrounding air temperature that exceeds 40°C (60°C max.), apply a suitable derating rate from the following graphs.

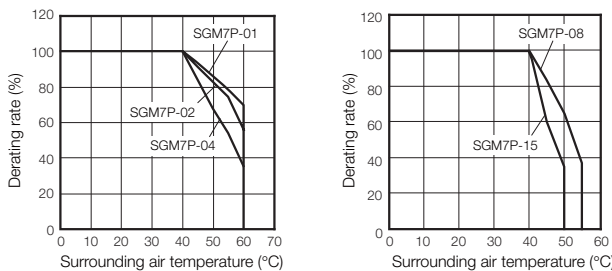

◆ Applications Where the Altitude Exceeds 1,000 m

The Servomotor ratings are the continuous allowable values at an altitude of 1,000 m or less. If you use a Servomotor at an altitude that exceeds 1,000 m (2,000 m max.), the heat dissipation effect of the air is reduced. Apply the appropriate derating rate from the following graphs.

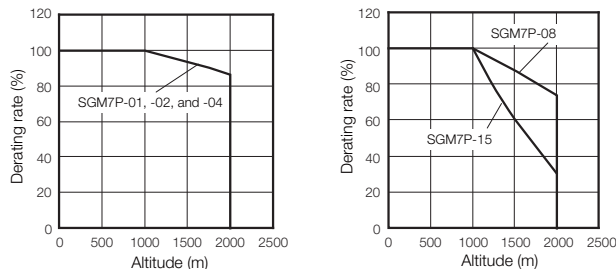

Information

When using Servomotors with derating, change the detection timing of overload warning and overload alarm based on the overload detection level of the motor given in *Servomotor Overload Protection Characteristics* (page 80).

Note: 1. Use the combination of the SERVOPACK and Servomotor so that the derating conditions are satisfied for both the SERVOPACK and Servomotor.

2. The derating rates are applicable only when the average motor speed is less than or equal to the rated motor speed. If the average motor speed exceeds the rated motor speed, consult with your Yaskawa representative.

External Dimensions

Servomotors without Gears

◆ SGM7P-01, -02, and -04

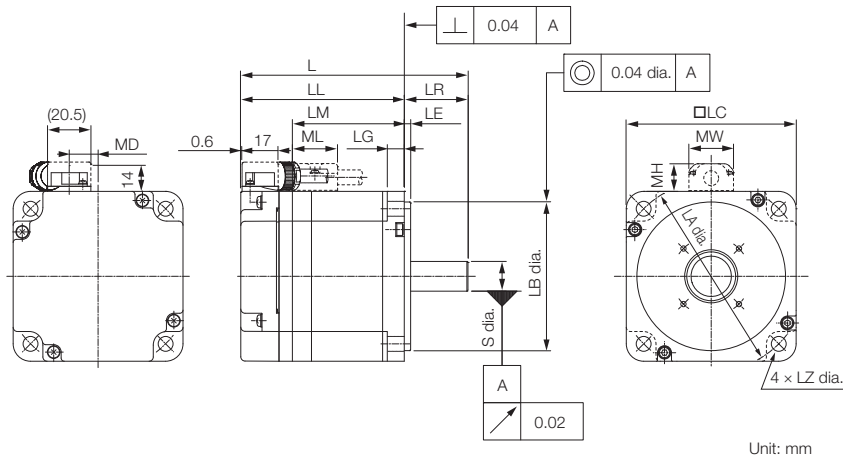

Model SGM7P-	L*	LL*	LM	Flange Dimensions							S	MD	MW	MH	ML	Approx. Mass* [kg]
				LR	LE	LG	LC	LA	LB	LZ						
01A□A2□	85 (115)	60 (90)	36	25	3	6	60	70	50 ⁰ _{-0.025}	5.5	8 ⁰ _{-0.009}	8.5	19	12	20	0.5 (0.9)
02A□A2□	97 (128.5)	67 (98.5)	43	30	3	8	80	90	70 ⁰ _{-0.030}	7	14 ⁰ _{-0.011}	13.6	21	13	21	1.1 (1.9)
04A□A2□	107 (138.5)	77 (108.5)	53	30	3	8	80	90	70 ⁰ _{-0.030}	7	14 ⁰ _{-0.011}	13.6	21	13	21	1.4 (2.2)

* For models that have a batteryless absolute encoder, L and LL are 8 mm greater and the approximate mass is 0.1 kg greater than the given value. Refer to the following section for the values for individual models.

☞ *Dimensions of Servomotors with Batteryless Absolute Encoders (page 89)*

Note: 1. The values in parentheses are for Servomotors with Holding Brakes.

2. The values for a straight, without key specification are given. Refer to the information given below for other shaft end specifications and option specifications.

■ Shaft End Specifications

- Straight with Key and Tap

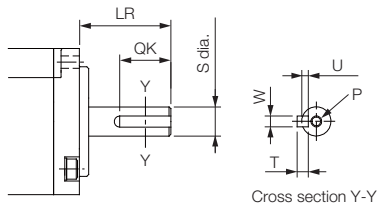

Model SGM7P-	LR	QK	S	W	T	U	P
01A□A6□	25	14	8 ⁰ _{-0.009}	3	3	1.8	M3×6L
02A□A6□	30	14	14 ⁰ _{-0.011}	5	5	3	M5×8L
04A□A6□	30	14	14 ⁰ _{-0.011}	5	5	3	M5×8L

■ Specifications of Options

- Oil Seal

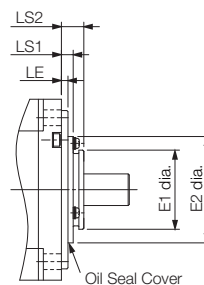

Model SGM7P-	Dimensions with Oil Seal				
	E1	E2	LS1	LS2	LE
01A□A2□	22	38	3.5	7	3
02A□A2□	35	47	5.2	10	3
04A□A2□					

◆ SGM7P-08 and -15

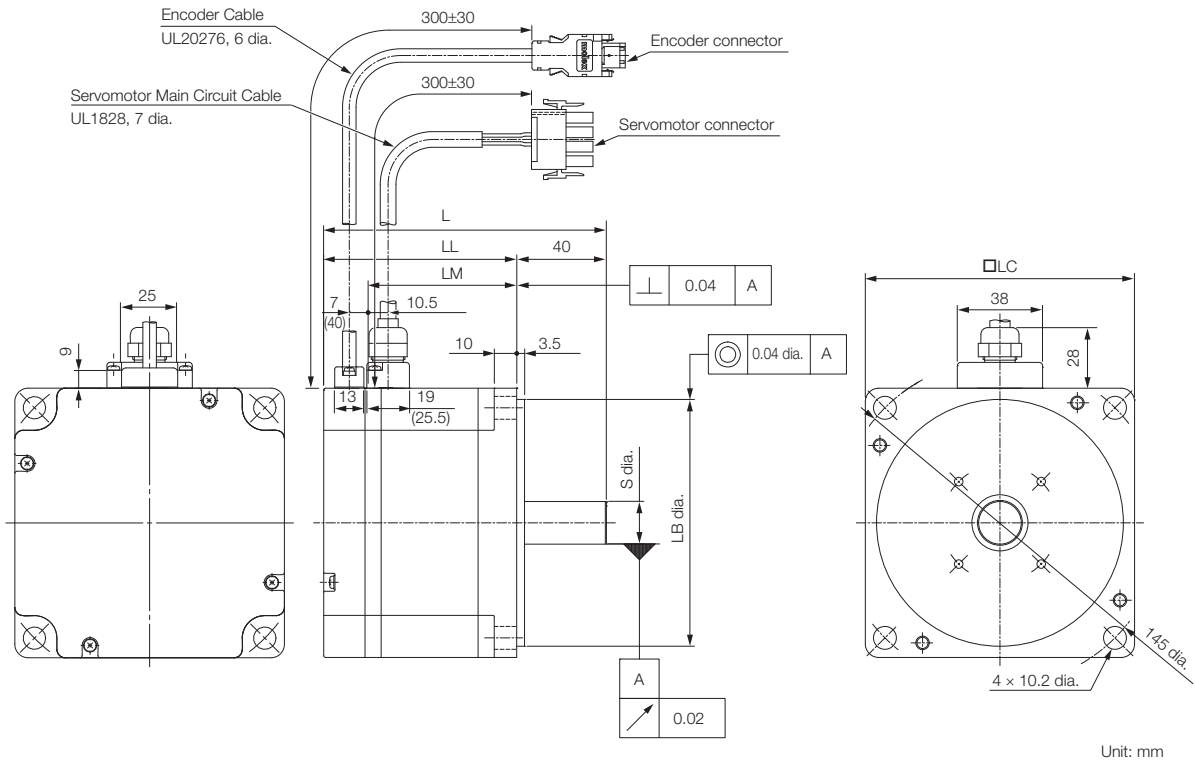

Model SGM7P-	L*	LL*	LM	LB	LC	S	Approx. Mass* [kg]
08A□A2□	126.5 (160)	86.5 (120)	67.6	110 ⁰ _{-0.035}	120	19 ⁰ _{-0.013}	4.2 (5.9)
15A□A2□	154.5 (187.5)	114.5 (147.5)	95.6	110 ⁰ _{-0.035}	120	19 ⁰ _{-0.013}	6.6 (8.2)

* For models that have a batteryless absolute encoder, L and LL are 8 mm greater and the approximate mass is 0.1 kg greater than the given value. Refer to the following section for the values for individual models.

📖 **Dimensions of Servomotors with Batteryless Absolute Encoders (page 89)**

Note: 1. The values in parentheses are for Servomotors with Holding Brakes.

2. The values for a straight, without key specification are given. Refer to the information given below for other shaft end specifications and option specifications.

■ **Shaft End Specifications**

- Straight with Key and Tap

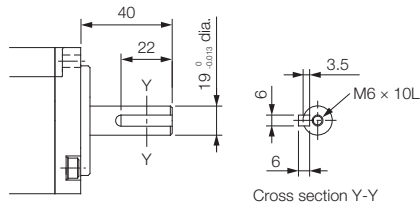

■ **Specifications of Options**

- Oil Seal

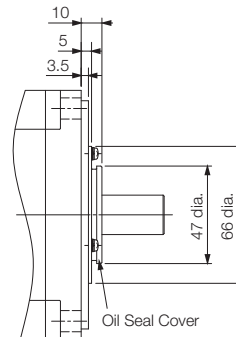

Servomotors with Gears

◆ SGM7P-01, -02, and -04

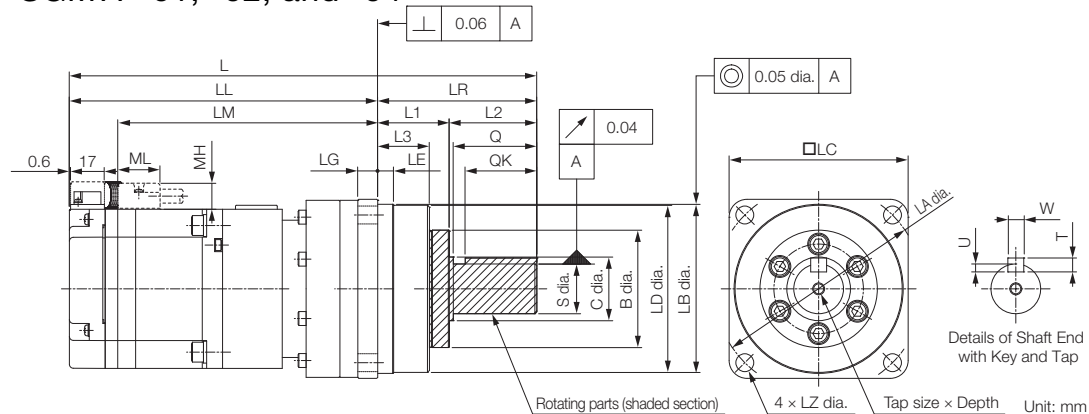

Model SGM7P-	Gear Ratio	L*	LL*	LM	Flange Dimensions								
					LR	LE	LG	B	LD	LB	LC	LA	LZ
01A□AH1□□	1/5	141.5 (171.5)	99.5 (129.5)	75.5	42	2.2	5	29	39.5	40 ⁰ _{-0.025}	40	46	3.4
01A□AHB□□	1/11	182 (212)	124 (154)	100	58	2.5	8	40	55.5	56 ⁰ _{-0.030}	60	70	5.5
01A□AHC□□	1/21												
01A□AH7□□	1/33	211 (241)	131 (161)	107	80	7.5	10	59	84	85 ⁰ _{-0.035}	90	105	9
02A□AH1□□	1/5	190 (221.5)	132 (163.5)	108	58	2.5	8	40	55.5	56 ⁰ _{-0.030}	60	70	5.5
02A□AHB□□	1/11												
02A□AHC□□	1/21	225 (256.5)	145 (176.5)	121	80	7.5	10	59	84	85 ⁰ _{-0.035}	90	105	9
02A□AH7□□	1/33												
04A□AH1□□	1/5	200 (231.5)	142 (173.5)	118	58	2.5	8	40	55.5	56 ⁰ _{-0.030}	60	70	5.5
04A□AHB□□	1/11	235 (266.5)	155 (186.5)	131	80	7.5	10	59	84	85 ⁰ _{-0.035}	90	105	9
04A□AHC□□	1/21												
04A□AH7□□	1/33	314 (345.5)	181 (212.5)	157	133	12.5	13	84	114	115 ⁰ _{-0.035}	120	135	11

Model SGM7P-	Flange Dimensions			Q	C	S	Tap Size × Depth	Key Dimensions				Approx. Mass* [kg]
	L1	L2	L3					QK	U	W	T	
01A□AH1□□	22	20	14.6	-	-	10 ⁰ _{-0.015}	M3 × 6L	15	2.5	4	4	0.9 (1.3)
01A□AHB□□	28	30	20	28	20	16 ⁰ _{-0.018}	M4 × 8L	25	3	5	5	1.6 (2.0)
01A□AHC□□												
01A□AH7□□	36	44	26	42	32	25 ⁰ _{-0.021}	M6 × 12L	36	4	8	7	3.4 (3.8)
02A□AH1□□	28	30	20	28	20	16 ⁰ _{-0.018}	M4 × 8L	25	3	5	5	2.3 (2.9)
02A□AHB□□												2.4 (3.0)
02A□AHC□□	36	44	26	42	32	25 ⁰ _{-0.021}	M6 × 12L	36	4	8	7	4.2 (5.0)
02A□AH7□□												
04A□AH1□□	28	30	20	28	20	16 ⁰ _{-0.018}	M4 × 8L	25	3	5	5	2.6 (3.2)
04A□AHB□□	36	44	26	42	32	25 ⁰ _{-0.021}	M6 × 12L	36	4	8	7	4.5 (5.3)
04A□AHC□□												
04A□AH7□□	48	85	33	82	44	40 ⁰ _{-0.025}	M10 × 20L	70	5	12	8	9.2 (10.0)

* For models that have a batteryless absolute encoder, L and LL are 8 mm greater and the approximate mass is 0.1 kg greater than the given value. Refer to the following section for the values for individual models.

🔧 **Dimensions of Servomotors with Batteryless Absolute Encoders (page 89)**

Note: 1. The values in parentheses are for Servomotors with Holding Brakes.

2. Gear dimensions are different from those of the Σ, Σ-II, and Σ-III Series.

3. The values for the shaft end are for a straight shaft with key and tap. If a key and tap are not necessary, specify shaft end code 2 for the 8th digit.

■ Flange Output Face

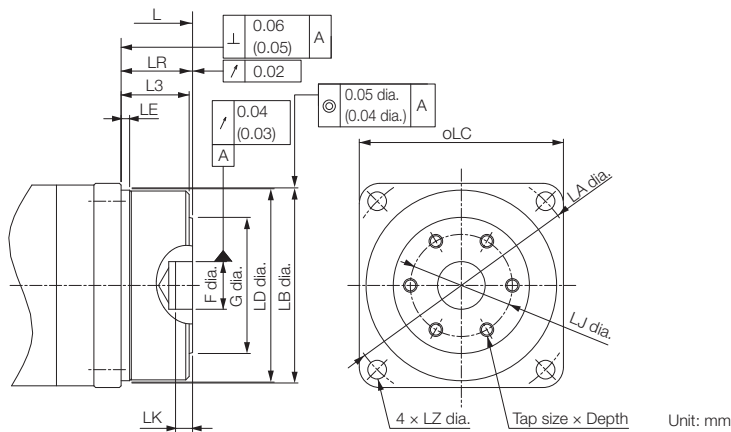

Note: The geometric tolerance in parentheses is the value for LC = 40.

Model SGM7P-	Gear Ratio	L*	LR	LJ	F	G	LK	No. of Taps × Tap Size × Depth	Approx. Mass* [kg]
01A□AH10□	1/5	114.5 (144.5)	15	18	$5^{+0.012}_0$	24	3	3 × M4 × 6L	0.8 (1.2)
01A□AHB0□	1/11	145 (175)	21	30	$14^{+0.018}_0$	40	5	6 × M4 × 7L	1.5 (1.9)
01A□AHC0□	1/21								
01A□AH70□	1/33	158 (188)	27	45	$24^{+0.021}_0$	59	5	6 × M6 × 10L	3.0 (3.4)
02A□AH10□	1/5	153 (184.5)	21	30	$14^{+0.018}_0$	40	5	6 × M4 × 7L	2.2 (2.8)
02A□AHB0□	1/11								2.3 (2.9)
02A□AHC0□	1/21	172 (203.5)	27	45	$24^{+0.021}_0$	59	5	6 × M6 × 10L	3.8 (4.6)
02A□AH70□	1/33								
04A□AH10□	1/5	163 (194.5)	21	30	$14^{+0.018}_0$	40	5	6 × M4 × 7L	2.5 (3.1)
04A□AHB0□	1/11	182 (213.5)	27	45	$24^{+0.021}_0$	59	5	6 × M6 × 10L	4.1 (4.9)
04A□AHC0□	1/21								
04A□AH70□	1/33	216 (247.5)	35	60	$32^{+0.025}_0$	84	5	6 × M8 × 12L	7.8 (8.6)

* For models that have a batteryless absolute encoder, L is 8 mm greater and the approximate mass is 0.1 kg greater than the given value. Refer to the following section for the values for individual models.

 **Dimensions of Servomotors with Batteryless Absolute Encoders (page 89)**

Note: 1. The values in parentheses are for Servomotors with Holding Brakes.

2. Dimensions not found in the above table are the same as those in the table on the previous page.

 **Important**

For a Servomotor with a flange output that has square gear flange dimensions (□LC) of 40 mm, we recommend that you design the Servomotor with the dimensions shown in the following figure in order to secure a gap between the gear oil seal and the connecting parts on the load side.

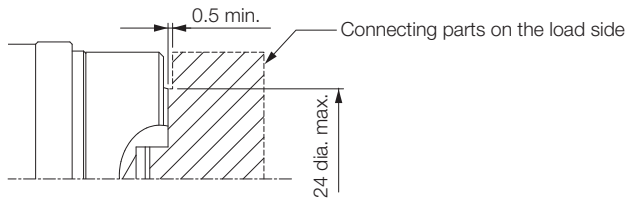

0.5 min.

Connecting parts on the load side

24 dia. max.

◆ SGM7P-08 and -15

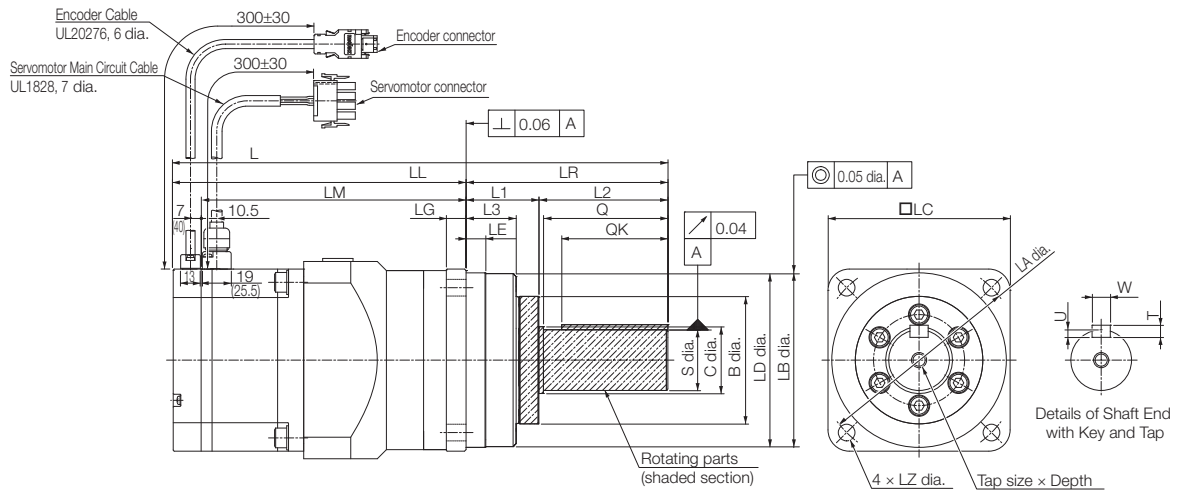

Unit: mm

Model SGM7P-	Gear Ratio	L*	LL*	LM	Flange Dimensions								
					LR	LE	LG	B	LD	LB	LC	LA	LZ
08A□AH1□□	1/5	253.5	173.5	154.6	80	7.5	10	59	84	85 ⁰ _{-0.035}	90	105	9
08A□AHB□□	1/11	(287)	(207)										
08A□AHC□□	1/21	326.5	193.5	174.6	133	12.5	13	84	114	115 ⁰ _{-0.035}	120	135	11
08A□AH7□□	1/33	(360)	(227)										
15A□AH1□□	1/5	354.5	221.5	202.6	133	12.5	13	84	114	115 ⁰ _{-0.035}	120	135	11
15A□AHB□□	1/11	(387.5)	(254.5)										
15A□AHC□□	1/21	393.5	237.5	218.6	156	12	16	122	163	165 ⁰ _{-0.063}	170	190	14
15A□AH7□□	1/33	(426.5)	(270.5)										

Model SGM7P-	Flange Dimensions			Q	C	S	Tap Size × Depth	Key Dimensions				Approx. Mass* [kg]
	L1	L2	L3					QK	U	W	T	
08A□AH1□□	36	44	26	42	32	25 ⁰ _{-0.021}	M6 × 12L	36	4	8	7	6.9 (8.6)
08A□AHB□□												7.1 (8.8)
08A□AHC□□	48	85	33	82	44	40 ⁰ _{-0.025}	M10 × 20L	70	5	12	8	12 (13.7)
08A□AH7□□												
15A□AH1□□	48	85	33	82	44	40 ⁰ _{-0.025}	M10 × 20L	70	5	12	8	13.9 (15.5)
15A□AHB□□												14.4 (16.0)
15A□AHC□□	70	86	51	82	56	50 ⁰ _{-0.025}	M10 × 20L	70	5.5	14	9	25.7 (27.3)
15A□AH7□□												

* For models that have a batteryless absolute encoder, L and LL are 8 mm greater and the approximate mass is 0.1 kg greater than the given value. Refer to the following section for the values for individual models.

🔧 **Dimensions of Servomotors with Batteryless Absolute Encoders (page 89)**

- Note: 1. The values in parentheses are for Servomotors with Holding Brakes.
 2. Gear dimensions are different from those of the Σ, Σ-II, and Σ-III Series.
 3. The values for the shaft end are for a straight shaft with key and tap. If a key and tap are not necessary, specify shaft end code 2 for the 8th digit.

■ Flange Output Face

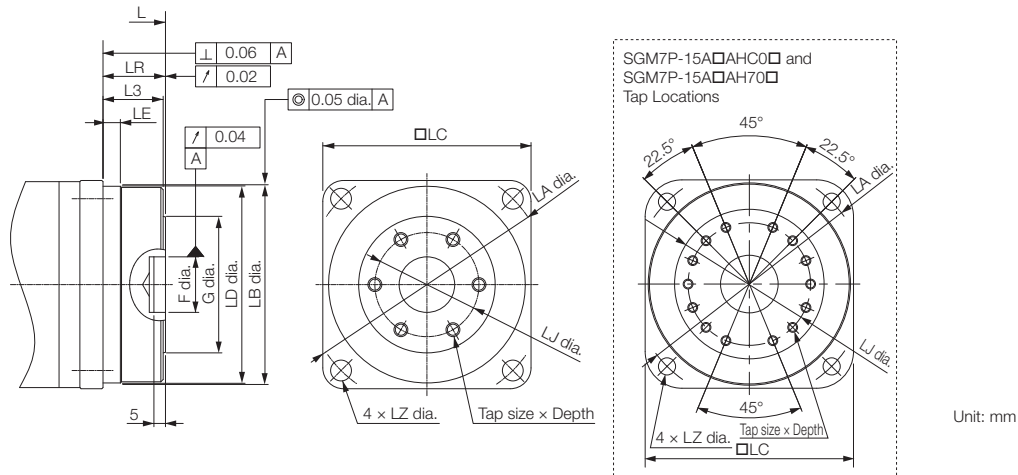

Model SGM7P-	Gear Ratio	L*	LR	LJ	F	G	LK	No. of Taps × Tap Size × Depth	Approx. Mass* [kg]
08A□AH10□	1/5	200.5	27	45	24 ^{+0.021} ₀	59	5	6 × M6 × 10L	6.5 (8.2)
08A□AHB0□	1/11	(234)							6.7 (8.4)
08A□AHC0□	1/21	228.5	35	60	32 ^{+0.025} ₀	84	5	6 × M8 × 12L	10.6 (12.3)
08A□AH70□	1/33	(262)							12.5 (14.1)
15A□AH10□	1/5	256.5	35	60	32 ^{+0.025} ₀	84	5	6 × M8 × 12L	13 (14.6)
15A□AHB0□	1/11	(289.5)							22.7 (24.3)
15A□AHC0□	1/21	290.5	53	100	47 ^{+0.025} ₀	122	7	14 × M8 × 12L	22.7 (24.3)
15A□AH70□	1/33	(323.5)							

* For models that have a batteryless absolute encoder, L is 8 mm greater and the approximate mass is 0.1 kg greater than the given value. Refer to the following section for the values for individual models.

Dimensions of Servomotors with Batteryless Absolute Encoders (page 89)

Note: 1. The values in parentheses are for Servomotors with Holding Brakes.

2. Dimensions not found in the above table are the same as those in the table on the previous page.

Dimensions of Servomotors with Batteryless Absolute Encoders

◆ Servomotors without Gears

Model SGM7P-	L	LL	Approx. Mass [kg]
01A6A2□	93 (123)	68 (98)	0.5 (0.9)
02A6A2□	105 (136.5)	75 (106.5)	1.2 (2.0)
04A6A2□	115 (146.5)	85 (116.5)	1.5 (2.3)
08A6A2□	134.5 (168)	94.5 (128)	4.3 (6.0)
15A6A2□	162.5 (195.5)	122.5 (155.5)	6.7 (8.3)

Note: The values in parentheses are for Servomotors with Holding Brakes.

◆ Servomotors with Gears

• Shaft End Specification: Straight

Model SGM7P-	L	LL	Approx. Mass [kg]
01A6AH1□□	149.5 (179.5)	107.5 (179.5)	0.9 (1.3)
01A6AHB□□	190 (220)	132 (162)	1.6 (2.0)
01A6AHC□□			
01A6AH7□□	219 (249)	139 (169)	3.4 (3.8)
02A6AH1□□	198 (229.5)	140 (171.5)	2.4 (3.0)
02A6AHB□□			2.5 (3.1)
02A6AHC□□	233 (264.5)	153 (184.5)	4.3 (5.1)
02A6AH7□□			
04A6AH1□□	208 (239.5)	150 (181.5)	2.7 (3.3)
04A6AHB□□	243 (274.5)	163 (194.5)	4.6 (5.4)
04A6AHC□□			
04A6AH7□□	322 (354.5)	191 (220.5)	9.3 (10.1)
08A6AH1□□	261.5 (295)	181.5 (215)	7.0 (8.7)
08A6AHB□□			7.2 (8.9)
08A6AHC□□	334.5 (368)	201.5 (235)	12.1 (13.8)
08A6AH7□□			
15A6AH1□□	362.5 (395.5)	229.5 (262.5)	14.0 (15.6)
15A6AHB□□			14.5 (16.1)
15A6AHC□□	401.5 (434.5)	245.5 (278.5)	25.8 (27.4)
15A6AH7□□			

• Shaft End Specification: Flange Output

Model SGM7P-	L	Approx. Mass [kg]
01A6AH10□	122.5 (152.5)	0.8 (1.2)
01A6AHB0□	153 (183)	1.5 (1.9)
01A6AHC0□		
01A6AH70□	166 (196)	3.0 (3.4)
02A6AH10□	161 (192.5)	2.3 (2.9)
02A6AHB0□		2.4 (3.0)
02A6AHC0□	180 (211.5)	3.9 (4.7)
02A6AH70□		
04A6AH10□	171 (202.5)	2.6 (3.2)
04A6AHB0□	190 (221.5)	4.2 (5.0)
04A6AHC0□		
04A6AH70□	224 (255.5)	7.9 (8.7)
08A6AH10□	208.5 (242)	6.6 (8.3)
08A6AHB0□		6.8 (8.5)
08A6AHC0□	236.5 (270)	10.7 (12.4)
08A6AH70□		
15A6AH10□	264.5 (297.5)	12.6 (14.2)
15A6AHB0□		13.1 (14.7)
15A6AHC0□	298.5 (331.5)	22.8 (24.4)
15A6AH70□		

Note: The values in parentheses are for Servomotors with Holding Brakes.

Selecting Cables

◆ Cable Configurations

The cables shown below are required to connect a Servomotor to a SERVOPACK.

Encoder Cable of 20 m or Less

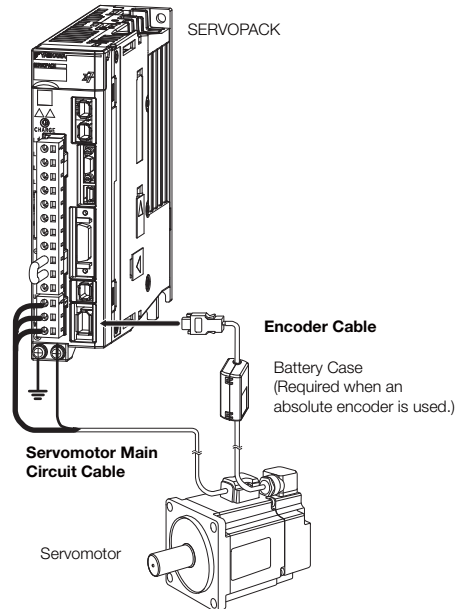

Encoder Cable of 30 m to 50 m (Relay Cable)

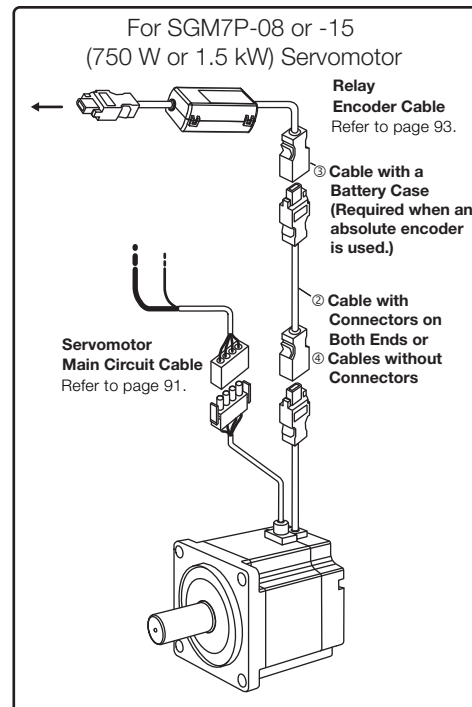
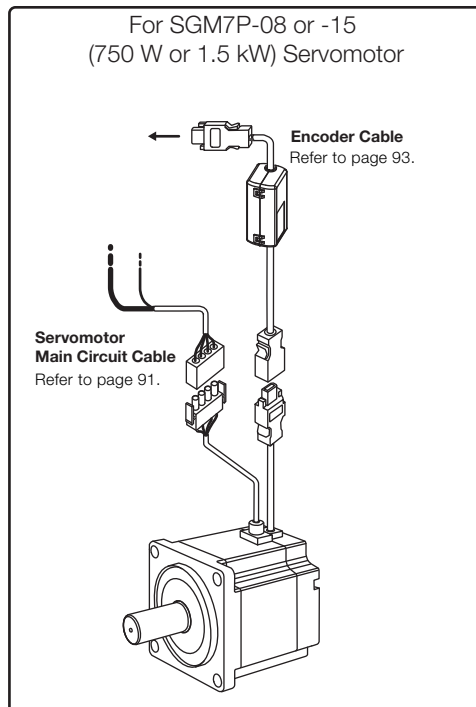
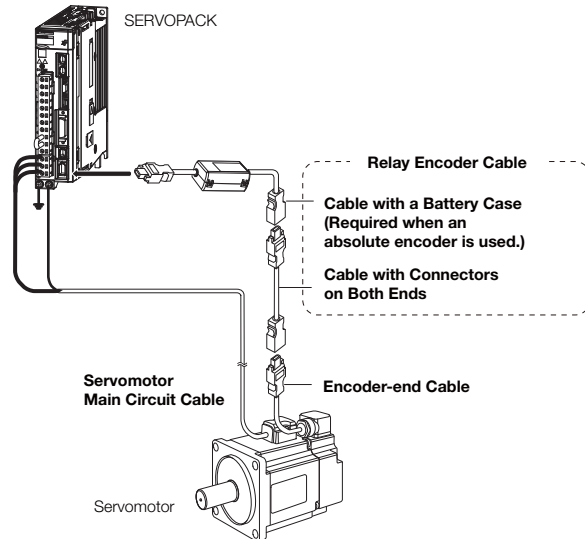

Note: 1. If the Encoder Cable length exceeds 20 m, be sure to use a Relay Encoder Cable.

2. If you use a Servomotor Main Circuit Cable that exceeds 20 m, the intermittent duty zone in the torque-motor speed characteristics will become smaller because the voltage drop increases.

3. Refer to the following manual for the following information.

- Cable dimensional drawings and cable connection specifications
- Order numbers and specifications of individual connectors for cables
- Order numbers and specifications for wiring materials

☞ Σ -7-Series AC Servo Drive Peripheral Device Selection Manual (Manual No.: SIEP S800001 32)

◆ Servomotor Main Circuit Cables

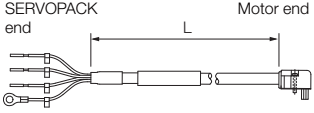
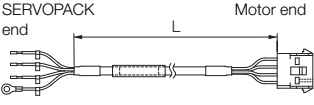
Servomotor Model	Name	Length (L)	Order Number		Appearance	
			Standard Cable	Flexible Cable*		
SGM7P-01 100 W	For Servo- motors without Holding Brakes	3 m	JZSP-CSM01-03-E	JZSP-CSM21-03-E		
		5 m	JZSP-CSM01-05-E	JZSP-CSM21-05-E		
		10 m	JZSP-CSM01-10-E	JZSP-CSM21-10-E		
		15 m	JZSP-CSM01-15-E	JZSP-CSM21-15-E		
		20 m	JZSP-CSM01-20-E	JZSP-CSM21-20-E		
		30 m	JZSP-CSM01-30-E	JZSP-CSM21-30-E		
		40 m	JZSP-CSM01-40-E	JZSP-CSM21-40-E		
50 m		JZSP-CSM01-50-E	JZSP-CSM21-50-E			
SGM7P-02 and -04 200 W, 400 W		3 m	JZSP-CSM02-03-E	JZSP-CSM22-03-E		
		5 m	JZSP-CSM02-05-E	JZSP-CSM22-05-E		
		10 m	JZSP-CSM02-10-E	JZSP-CSM22-10-E		
		15 m	JZSP-CSM02-15-E	JZSP-CSM22-15-E		
		20 m	JZSP-CSM02-20-E	JZSP-CSM22-20-E		
		30 m	JZSP-CSM02-30-E	JZSP-CSM22-30-E		
		40 m	JZSP-CSM02-40-E	JZSP-CSM22-40-E		
50 m		JZSP-CSM02-50-E	JZSP-CSM22-50-E			
SGM7P-08 750 W		3 m	JZSP-CMM00-03-E	JZSP-CMM01-03-E		
		5 m	JZSP-CMM00-05-E	JZSP-CMM01-05-E		
		10 m	JZSP-CMM00-10-E	JZSP-CMM01-10-E		
		15 m	JZSP-CMM00-15-E	JZSP-CMM01-15-E		
	20 m	JZSP-CMM00-20-E	JZSP-CMM01-20-E			
	30 m	JZSP-CMM00-30-E	JZSP-CMM01-30-E			
	40 m	JZSP-CMM00-40-E	JZSP-CMM01-40-E			
50 m	JZSP-CMM00-50-E	JZSP-CMM01-50-E				
SGM7P-15 1.5 kW	3 m	JZSP-CMM20-03-E	—			
	5 m	JZSP-CMM20-05-E	—			
	10 m	JZSP-CMM20-10-E	—			
	15 m	JZSP-CMM20-15-E	—			
	20 m	JZSP-CMM20-20-E	—			

* Use Flexible Cables for moving parts of machines, such as robots. The recommended bending radius (R) is 90 mm or larger.

Rotary Servomotors
SGM7P

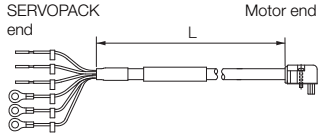
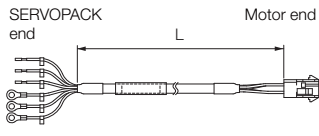
Servomotor Model	Name	Length (L)	Order Number		Appearance
			Standard Cable	Flexible Cable*	
SGM7P-01 100 W	For Servo- motors with Holding Brakes	3 m	JZSP-CSM11-03-E	JZSP-CSM31-03-E	
		5 m	JZSP-CSM11-05-E	JZSP-CSM31-05-E	
		10 m	JZSP-CSM11-10-E	JZSP-CSM31-10-E	
		15 m	JZSP-CSM11-15-E	JZSP-CSM31-15-E	
		20 m	JZSP-CSM11-20-E	JZSP-CSM31-20-E	
		30 m	JZSP-CSM11-30-E	JZSP-CSM31-30-E	
		40 m	JZSP-CSM11-40-E	JZSP-CSM31-40-E	
50 m		JZSP-CSM11-50-E	JZSP-CSM31-50-E		
SGM7P-02 and -04 200 W, 400 W		3 m	JZSP-CSM12-03-E	JZSP-CSM32-03-E	
		5 m	JZSP-CSM12-05-E	JZSP-CSM32-05-E	
		10 m	JZSP-CSM12-10-E	JZSP-CSM32-10-E	
		15 m	JZSP-CSM12-15-E	JZSP-CSM32-15-E	
		20 m	JZSP-CSM12-20-E	JZSP-CSM32-20-E	
		30 m	JZSP-CSM12-30-E	JZSP-CSM32-30-E	
	40 m	JZSP-CSM12-40-E	JZSP-CSM32-40-E		
SGM7P-08 750 W	3 m	JZSP-CMM10-03-E	JZSP-CMM11-03-E		
	5 m	JZSP-CMM10-05-E	JZSP-CMM11-05-E		
	10 m	JZSP-CMM10-10-E	JZSP-CMM11-10-E		
	15 m	JZSP-CMM10-15-E	JZSP-CMM11-15-E		
	20 m	JZSP-CMM10-20-E	JZSP-CMM11-20-E		
	30 m	JZSP-CMM10-30-E	JZSP-CMM11-30-E		
	40 m	JZSP-CMM10-40-E	JZSP-CMM11-40-E		
SGM7P-15 1.5 kW	3 m	JZSP-CMM30-03-E	—		
	5 m	JZSP-CMM30-05-E	—		
	10 m	JZSP-CMM30-10-E	—		
	15 m	JZSP-CMM30-15-E	—		
	20 m	JZSP-CMM30-20-E	—		

* Use Flexible Cables for moving parts of machines, such as robots. The recommended bending radius (R) is 90 mm or larger.

◆ Encoder Cables of 20 m or Less

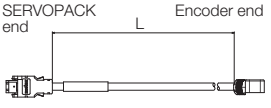
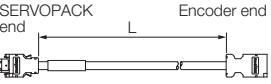
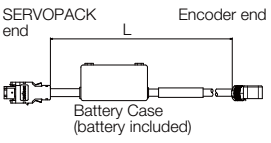
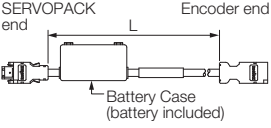
Servomotor Model	Name	Length (L)	Order Number		Appearance
			Standard Cable	Flexible Cable* ¹	
SGM7P-01, -02 and -04 100 W, 200 W, 400 W	For incremental encoder, or batteryless absolute encoder	3 m	JZSP-C7PI0D-03-E	JZSP-C7PI2D-03-E	
		5 m	JZSP-C7PI0D-05-E	JZSP-C7PI2D-05-E	
		10 m	JZSP-C7PI0D-10-E	JZSP-C7PI2D-10-E	
		15 m	JZSP-C7PI0D-15-E	JZSP-C7PI2D-15-E	
		20 m	JZSP-C7PI0D-20-E	JZSP-C7PI2D-20-E	
SGM7P-08 and -15 750 W, 1500 W	Cable installed toward load	3 m	JZSP-CMP00-03-E	JZSP-CMP10-03-E	
		5 m	JZSP-CMP00-05-E	JZSP-CMP10-05-E	
		10 m	JZSP-CMP00-10-E	JZSP-CMP10-10-E	
		15 m	JZSP-CMP00-15-E	JZSP-CMP10-15-E	
SGM7P-01, -02 and -04 100 W, 200 W, 400 W	For absolute encoder: With Battery Case* ²	3 m	JZSP-C7PA0D-03-E	JZSP-C7PA2D-03-E	
		5 m	JZSP-C7PA0D-05-E	JZSP-C7PA2D-05-E	
		10 m	JZSP-C7PA0D-10-E	JZSP-C7PA2D-10-E	
		15 m	JZSP-C7PA0D-15-E	JZSP-C7PA2D-15-E	
		20 m	JZSP-C7PA0D-20-E	JZSP-C7PA2D-20-E	
SGM7P-08 and -15 750 W, 1500 W	Cable installed toward load	3 m	JZSP-CSP19-03-E	JZSP-CSP29-03-E	
		5 m	JZSP-CSP19-05-E	JZSP-CSP29-05-E	
		10 m	JZSP-CSP19-10-E	JZSP-CSP29-10-E	
		15 m	JZSP-CSP19-15-E	JZSP-CSP29-15-E	
		20 m	JZSP-CSP19-20-E	JZSP-CSP29-20-E	

*1. Use Flexible Cables for moving parts of machines, such as robots. The recommended bending radius (R) is 90 mm or larger.

*2. If a battery is connected to the host controller, the Battery Case is not required. If so, use a cable for incremental encoders.

◆ Relay Encoder Cables of 30 m to 50 m

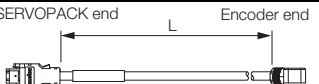
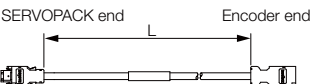
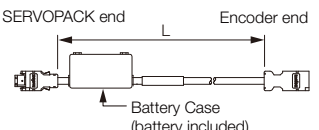
Servomotor Model	Name	Length (L)	Order Number	Appearance
All SGM7P models	Encoder-end Cable (for all types of encoders) Cable installed toward load	0.3 m	JZSP-C7PRCD-E	
	Cables with Connectors on Both Ends (for all types of encoders)	30 m	JZSP-UCMP00-30-E	
		40 m	JZSP-UCMP00-40-E	
		50 m	JZSP-UCMP00-50-E	
	Cable with a Battery Case (Required when an absolute encoder is used.*)	0.3 m	JZSP-CSP12-E	

* This Cable is not required if you use a Servomotor with a Batteryless Absolute Encoder, and you connect a battery to the host controller.

SGM7G

Model Designations



Σ-7 Series
Servomotors:
SGM7G

1st+2nd digits Rated Output

Code	Specification
03	300 W
05	450 W
09	850 W
13	1.3 kW
20	1.8 kW
30	2.9 kW*
44	4.4 kW
55	5.5 kW
75	7.5 kW
1A	11 kW
1E	15 kW

* The rated output is 2.4 kW if you combine the SGM7G-30A with the SGD7S-200A.

3rd digit Power Supply Voltage

Code	Specification
A	200 VAC

4th digit Serial Encoder

Code	Specification
6	24-bit batteryless absolute
7	24-bit absolute
F	24-bit incremental

5th digit Design Revision Order

A

6th digit Shaft End

Code	Specification
2	Straight without key
6	Straight with key and tap

7th digit Options

Code	Specification
1	Without options
C	With holding brake (24 VDC)
E	With oil seal and holding brake (24 VDC)
S	With oil seal

Specifications and Ratings

Specifications

Voltage		200 V										
Model SGM7G-		03A	05A	09A	13A	20A	30A	44A	55A	75A	1AA	1EA
Time Rating		Continuous										
Thermal Class		UL: F, CE: F										
Insulation Resistance		500 VDC, 10 MΩ min.										
Withstand Voltage		1,500 VAC for 1 minute										
Excitation		Permanent magnet										
Mounting		Flange-mounted										
Drive Method		Direct drive										
Rotation Direction		Counterclockwise (CCW) for forward reference when viewed from the load side										
Vibration Class*1		V15										
Environmental Conditions	Surrounding Air Temperature	0°C to 40°C (60°C max.)*3										
	Surrounding Air Humidity	20% to 80% relative humidity (with no condensation)										
	Installation Site	<ul style="list-style-type: none"> • Must be indoors and free of corrosive and explosive gases. • Must be well-ventilated and free of dust and moisture. • Must facilitate inspection and cleaning. • Must have an altitude of 1,000 m or less. (With derating, usage is possible between 1,000 m and 2,000 m.)*3 • Must be free of strong magnetic fields. 										
	Storage Environment	Store the Servomotor in the following environment if you store it with the power cable disconnected. Storage Temperature: -20°C to 60°C (with no freezing) Storage Humidity: 20% to 80% relative humidity (with no condensation)										
Shock Resistance*2	Impact Acceleration Rate at Flange	490 m/s ²										
	Number of Impacts	2 times										
Vibration Resistance*2	Vibration Acceleration Rate at Flange	49 m/s ² (24.5 m/s ² front to back)							24.5 m/s ²			
Applicable SERVOPACKs	SGD7S-	3R8A	7R6A	120A	180A	330A	470A	550A	590A	780A		
	SGD7W- SGD7C-	5R5A*4, 7R6A*4	7A6A	-								

*1. A vibration class of V15 indicates a vibration amplitude of 15 μm maximum on the Servomotor without a load at the rated motor speed.

*2. The given values are for when the Servomotor shaft is mounted horizontally and shock or vibration is applied in the directions shown in the following figures.

The strength of the vibration that the Servomotor can withstand depends on the application. Always check the vibration acceleration rate that is applied to the Servomotor with the actual equipment.

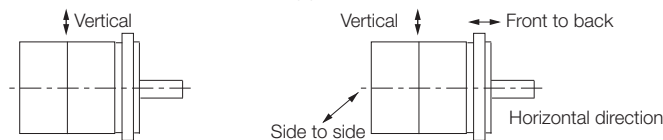

Shock Applied to the Servomotor

Vibration Applied to the Servomotor

*3. Refer to the following section for the derating rates.

Derating Rates (page 102)

*4. If you use a Servomotor together with a Σ-7W or Σ-7C SERVOPACK, the control gain may not increase as much as with a Σ-7S SERVOPACK and other performances may be lower than those achieved with a Σ-7S SERVOPACK.

Servomotor Ratings

Voltage		200 V				
Model SGM7G-		03A	05A	09A	13A	20A
Rated Output* ¹	kW	0.3	0.45	0.85	1.3	1.8
Rated Torque* ^{1, *2}	N·m	1.96	2.86	5.39	8.34	11.5
Instantaneous Maximum Torque* ¹	N·m	5.88	8.92	14.2	23.3	28.7
Rated Current* ¹	Arms	2.8	3.8	6.9	10.7	16.7
Instantaneous Maximum Current* ¹	Arms	8.0	11	17	28	42
Rated Motor Speed* ¹	min ⁻¹	1500				
Maximum Motor Speed* ¹	min ⁻¹	3000				
Torque Constant	N·m/Arms	0.776	0.854	0.859	0.891	0.748
Motor Moment of Inertia	×10 ⁻⁴ kg·m ²	2.48 (2.73)	3.33 (3.58)	13.9 (16.0)	19.9 (22.0)	26.0 (28.1)
Rated Power Rate* ¹	kW/s	15.5 (14.1)	24.6 (22.8)	20.9 (18.2)	35.0 (31.6)	50.9 (47.1)
Rated Angular Acceleration Rate* ¹	rad/s ²	7900 (7180)	8590 (7990)	3880 (3370)	4190 (3790)	4420 (4090)
Heat Sink Size* ³	mm	250 × 250 × 6 (aluminum)		400 × 400 × 20 (steel)		
Protective Structure* ⁴		Totally enclosed, self-cooled, IP67				
Holding Brake Specifications* ⁵	Rated Voltage	V	24 VDC ^{+10%} ₀			
	Capacity	W	10			
	Holding Torque	N·m	4.5	12.7	19.6	
	Coil Resistance	Ω (at 20°C)	56	59		
	Rated Current	A (at 20°C)	0.43	0.41		
	Time Required to Release Brake	ms	100			
	Time Required to Brake	ms	80			
Allowable Load Moment of Inertia (Motor Moment of Inertia Ratio)* ⁶			15 times	5 times		
With External Regenerative Resistor and External Dynamic Brake Resistor			15 times	10 times		
Allowable Shaft Loads* ⁷	LF	mm	40	58		
	Allowable Radial Load	N	490		686	980
	Allowable Thrust Load	N	98	343		392

Note: The values in parentheses are for Servomotors with Holding Brakes.

*1. These values are for operation in combination with a SERVOPACK when the temperature of the armature winding is 20°C. These are typical values.

*2. The rated torques are the continuous allowable torque values with an aluminum or steel heat sink of the dimensions given in the table.

*3. Refer to the following section for the relation between the heat sinks and derating rate.

 **Servomotor Heat Dissipation Conditions (page 102)**

*4. This does not apply to the shaft opening. Protective structure specifications apply only when the special cable is used.

*5. Observe the following precautions if you use a Servomotor with a Holding Brake.

- The holding brake cannot be used to stop the Servomotor.
- The time required to release the brake and the time required to brake depend on which discharge circuit is used. Confirm that the operation delay time is appropriate for the actual equipment.
- The 24-VDC power supply is not provided by Yaskawa.

*6. The motor moment of inertia scaling factor is the value for a standard Servomotor without a Holding Brake.

*7. Design the mechanical system so that the thrust and radial loads applied to the Servomotor shaft end during operation do not exceed the values given in the table.

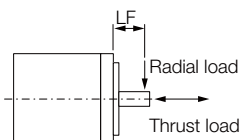

Torque-Motor Speed Characteristics

A : Continuous duty zone — (solid lines): With three-phase 200-V or single-phase 230-V input
B : Intermittent duty zone - - - - (dotted lines): With single-phase 200-V input

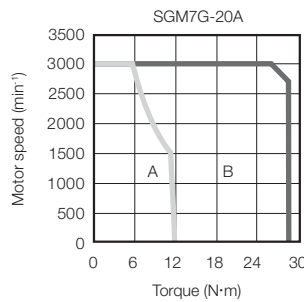
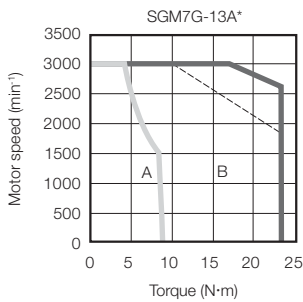
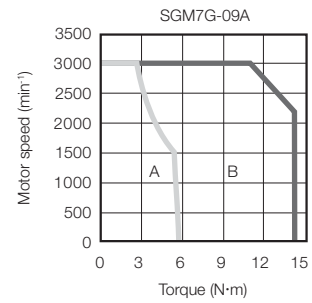
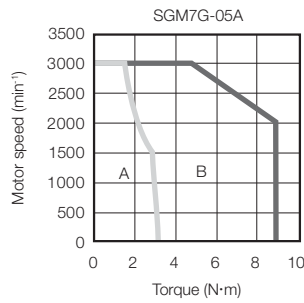
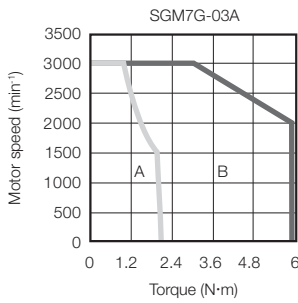

* A single-phase power input can be used in combination with the SGD7S-120A□□A008.

Note: 1. These values (typical values) are for operation in combination with a SERVOPACK when the temperature of the armature winding is 20°C.

2. The characteristics in the intermittent duty zone depend on the power supply voltage.
3. If the effective torque is within the allowable range for the rated torque, the Servomotor can be used within the intermittent duty zone.
4. If you use a Servomotor Main Circuit Cable that exceeds 20 m, the intermittent duty zone in the torque-motor speed characteristics will become smaller because the voltage drop increases.

Servomotor Ratings

Voltage		200 V						
Model SGM7G-		30A	30A*6	44A	55A	75A	1AA	1EA
Rated Output*1	kW	2.9	2.4	4.4	5.5	7.5	11	15
Rated Torque*1, *2	N·m	18.6	15.1	28.4	35.0	48.0	70.0	95.4
Instantaneous Maximum Torque*1	N·m	54.0	45.1	71.6	102	119	175	224
Rated Current*1	Arms	23.8	19.6	32.8	37.2	54.7	58.6	78.0
Instantaneous Maximum Current*1	Arms	70	56	84	110	130	140	170
Rated Motor Speed*1	min ⁻¹	1500	1500	1500	1500	1500	1500	1500
Maximum Motor Speed*1	min ⁻¹	3000	3000	3000	3000	3000	2000	2000
Torque Constant	N·m/Arms	0.848	0.848	0.934	1.00	0.957	1.38	1.44
Motor Moment of Inertia	×10 ⁻⁴ kg·m ²	46.0 (53.9)	46.0 (53.9)	67.5 (75.4)	89.0 (96.9)	125 (133)	242 (261)	303 (341)
Rated Power Rate*1	kW/s	75.2 (64.2)	49.5 (42.2)	119 (107)	138 (126)	184 (173)	202 (188)	300 (267)
Rated Angular Acceleration Rate*1	rad/s ²	4040 (3450)	3280 (2800)	4210 (3770)	3930 (3610)	3840 (3610)	2890 (2680)	3150 (2800)
Heat Sink Size*3	mm	550 × 550 × 30 (steel)					650 × 650 × 35 (steel)	
Protective Structure*4	Totally enclosed, self-cooled, IP67							
Holding Brake Specifications*5	Rated Voltage	V	24 VDC ^{+10%} ₀					
	Capacity	W	18.5		25	32	35	
	Holding Torque	N·m	43.1		72.6	84.3	114.6	
	Coil Resistance	Ω (at 20°C)	31		23	18	17	
	Rated Current	A (at 20°C)	0.77		1.05	1.33	1.46	
	Time Required to Release Brake	ms	170					250
	Time Required to Brake	ms	100			80		
Allowable Load Moment of Inertia (Motor Moment of Inertia Ratio)*6		5 times	3 times	5 times				
	With External Regenerative Resistor and External Dynamic Brake Resistor	10 times	7 times	10 times				
Allowable Shaft Loads*7	LF	mm	79			113	116	
	Allowable Radial Load	N	1470			1764		4998
	Allowable Thrust Load	N	490			588		2156

Note: The values in parentheses are for Servomotors with Holding Brakes.

*1. These values are for operation in combination with a SERVOPACK when the temperature of the armature winding is 20°C. These are typical values.

*2. The rated torques are the continuous allowable torque values with an aluminum or steel heat sink of the dimensions given in the table.

*3. Refer to the following section for the relation between the heat sinks and derating rate.

 **Servomotor Heat Dissipation Conditions (page 102)**

*4. This does not apply to the shaft opening. Protective structure specifications apply only when the special cable is used.

*5. Observe the following precautions if you use a Servomotor with a Holding Brake.

- The holding brake cannot be used to stop the Servomotor.
- The time required to release the brake and the time required to brake depend on which discharge circuit is used. Confirm that the operation delay time is appropriate for the actual equipment.
- The 24-VDC power supply is not provided by Yaskawa.

*6. The motor moment of inertia scaling factor is the value for a standard Servomotor without a Holding Brake.

*7. Design the mechanical system so that the thrust and radial loads applied to the Servomotor shaft end during operation do not exceed the values given in the table.

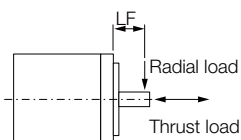

*8. This is the value if you combine the SGM7G-30A with the SGD7S-200A.

Torque-Motor Speed Characteristics

A : Continuous duty zone — (solid lines): With three-phase 200-V input
B : Intermittent duty zone - - - (dotted lines): When combined with the SGD7S-200A

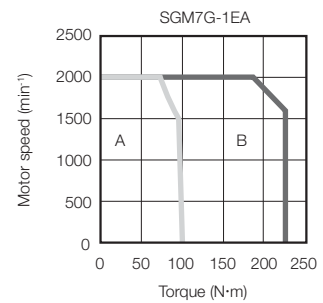
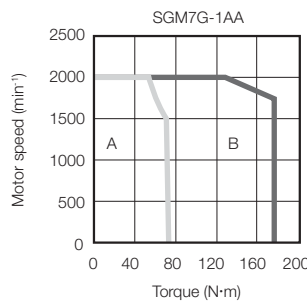
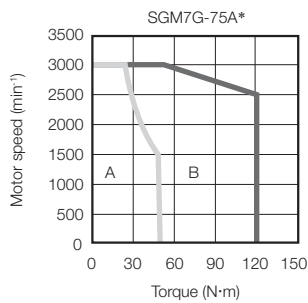
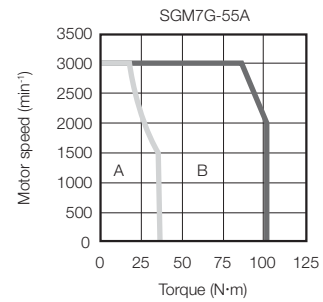
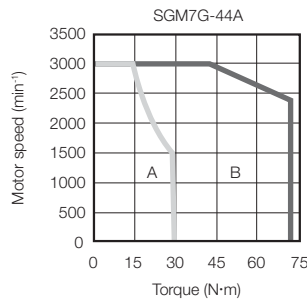
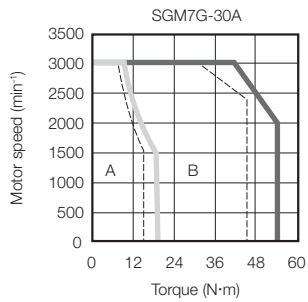

* Use an SGM7G-75A Servomotor with a Holding Brake with an output torque of 14.4 N·m (30% of the rated torque) or lower when using the Servomotor in continuous operation at the maximum motor speed of 3,000 min⁻¹.

Note: 1. These values (typical values) are for operation in combination with a SERVOPACK when the temperature of the armature winding is 20°C.

2. The characteristics in the intermittent duty zone depend on the power supply voltage.
3. If the effective torque is within the allowable range for the rated torque, the Servomotor can be used within the intermittent duty zone.
4. If you use a Servomotor Main Circuit Cable that exceeds 20 m, the intermittent duty zone in the torque-motor speed characteristics will become smaller because the voltage drop increases.

Servomotor Overload Protection Characteristics

The overload detection level is set for hot start conditions with a Servomotor surrounding air temperature of 40°C.

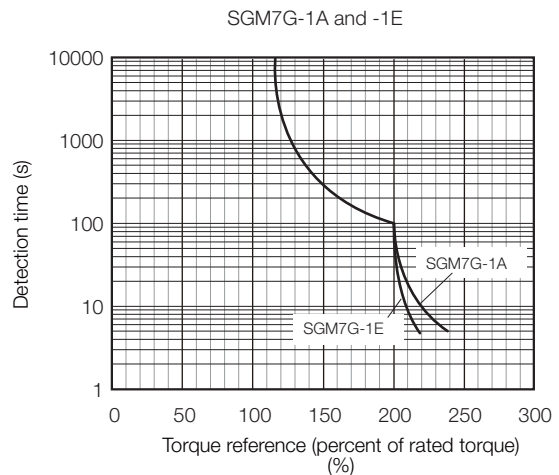
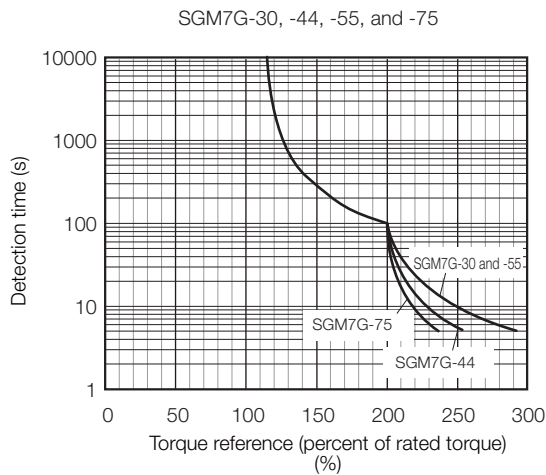
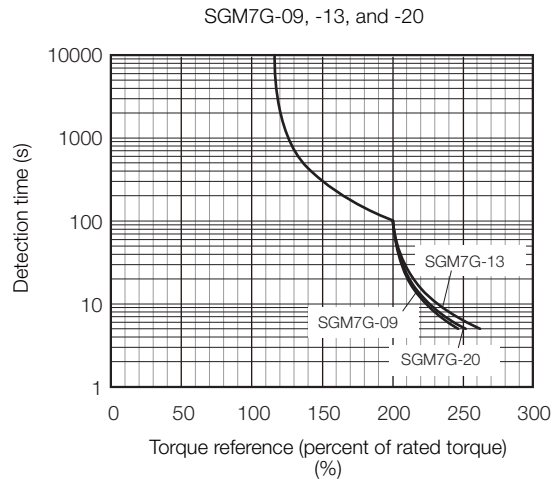
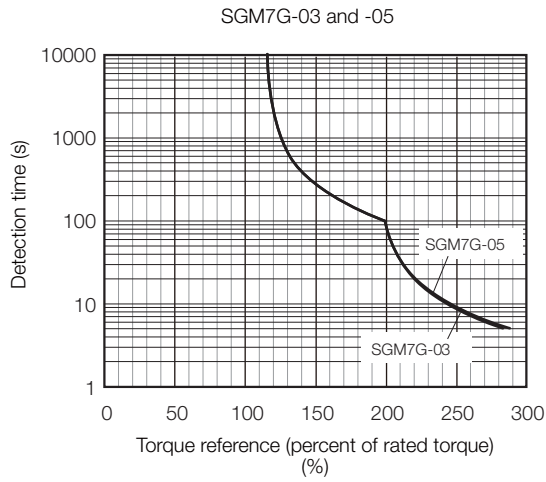

Note: The above overload protection characteristics do not mean that you can perform continuous duty operation with an output of 100% or higher. Use the Servomotor so that the effective torque remains within the continuous duty zone given in *Torque-Motor Speed Characteristics* on page 99.

Allowable Load Moment of Inertia

The allowable load moments of inertia (motor moment of inertia ratios) for the Servomotors are given in the *Servomotor Ratings* (pages 96 and 98). The values are determined by the regenerative energy processing capacity of the SERVOPACK and are also affected by the drive conditions of the Servomotor. Perform the required Steps for each of the following cases.

Use the SigmaSize+ AC Servo Drive Capacity Selection Program to check the driving conditions. Contact your Yaskawa representative for information on this program.

◆ Exceeding the Allowable Load Moment of Inertia

Use one of the following measures to adjust the load moment of inertia to within the allowable value.

- Reduce the torque limit.
- Reduce the deceleration rate.
- Reduce the maximum motor speed.

If the above steps is not possible, install an external regenerative resistor.

Information An Overvoltage Alarm (A.400) is likely to occur during deceleration if the load moment of inertia exceeds the allowable load moment of inertia. SERVOPACKs with a built-in regenerative resistor may generate a Regenerative Overload Alarm (A.320). Refer to *Built-In Regenerative Resistor* (page 472) for the regenerative power (W) that can be processed by the SERVOPACKs.

Install an External Regenerative Resistor when the built-in regenerative resistor cannot process all of the regenerative power.

◆ When an External Regenerative Resistor Is Required

Install the External Regenerative Resistor. Refer to the following section for the recommended products.

 *External Regenerative Resistors* (page 472)

Derating Rates

◆ Servomotor Heat Dissipation Conditions

The Servomotor ratings are the continuous allowable values when a heat sink is installed on the Servomotor. If the Servomotor is mounted on a small device component, the Servomotor temperature may rise considerably because the surface for heat dissipation becomes smaller. Refer to the following graphs for the relation between the heat sink size and derating rate.

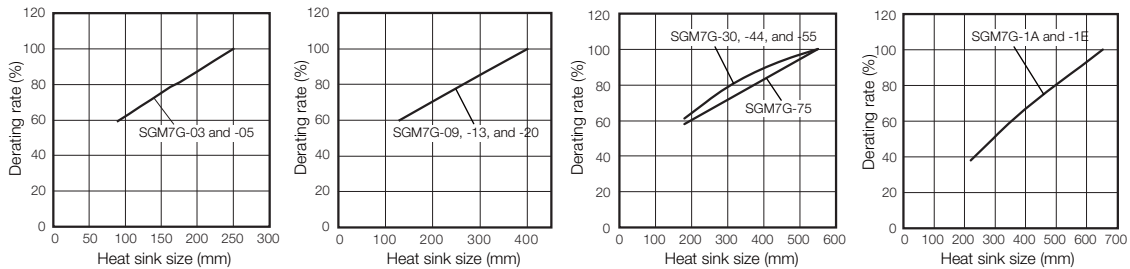

Important

The actual temperature rise depends on how the heat sink (i.e., the Servomotor mounting section) is attached to the installation surface, what material is used for the Servomotor mounting section, and the motor speed. Always check the Servomotor temperature with the actual equipment.

◆ Servomotor Derating Rates for Surrounding Air Temperatures

Apply a suitable derating rate from the following graphs according to the surrounding air temperature of the Servomotor (60°C max.).

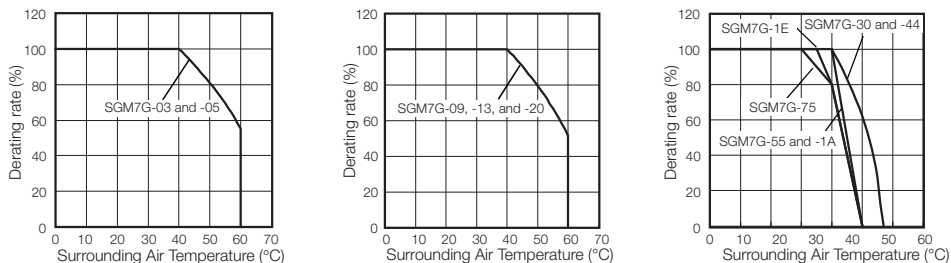

◆ Applications Where the Altitude Exceeds 1,000 m

The Servomotor ratings are the continuous allowable values at an altitude of 1,000 m or less. If you use a Servomotor at an altitude that exceeds 1,000 m (2,000 m max.), the heat dissipation effect of the air is reduced. Apply the appropriate derating rate from the following graphs.

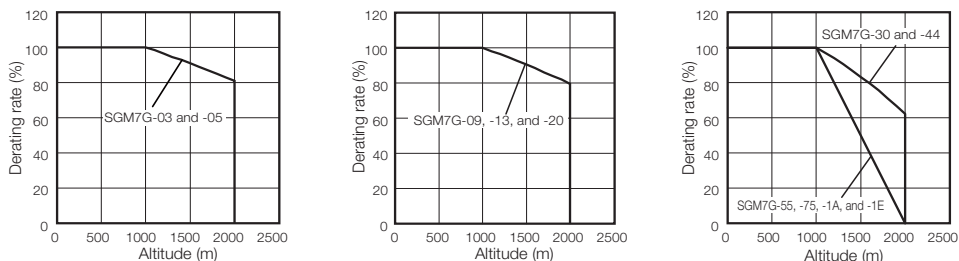

Information

When using Servomotors with derating, change the detection timing of overload warning and overload alarm based on the overload detection level of the motor given in *Servomotor Overload Protection Characteristics* (page 100).

Note: 1. Use the combination of the SERVOPACK and Servomotor so that the derating conditions are satisfied for both the SERVOPACK and Servomotor.

2. The derating rates are applicable only when the average motor speed is less than or equal to the rated motor speed. If the average motor speed exceeds the rated motor speed, consult with your Yaskawa representative.

External Dimensions

Servomotors without Holding Brakes

◆ SGM7G-03 and -05

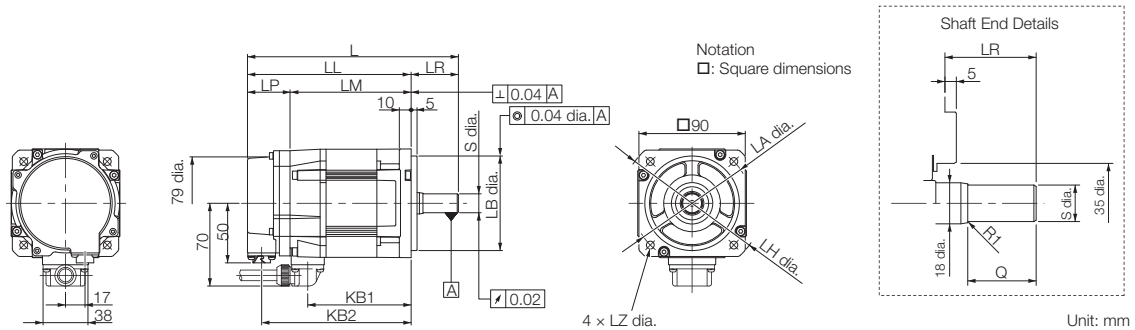

Model SGM7G-	L* ¹	LL* ¹	LM	LP* ¹	LR	KB1	KB2* ¹	KL1
03A□A21	166* ²	126	90	36	40* ²	75	114	70
05A□A21	179	139	103	36	40	88	127	70

Model SGM7G-	Flange Dimensions							Shaft End Dimensions		Approx. Mass [kg]
	LA	LB	LC	LE	LG	LH	LZ	S	Q	
03A□A21	100	80 ⁰ _{-0.030}	90	5	10	120	6.6	16 ⁰ _{-0.011} * ²	30* ²	2.6
05A□A21	100	80 ⁰ _{-0.030}	90	5	10	120	6.6	16 ⁰ _{-0.011}	30	3.2

*1. For models that have a batteryless absolute encoder, L, LL, LP, and KB2 are 8 mm greater than the given value. Refer to the following section for the values for individual models.

Dimensions of Servomotors with Batteryless Absolute Encoders (page 109)

*2. The L, LR, S, and Q dimensions of these Servomotors are different from those of the Σ-V-series SGMGV Servomotors.

Models that have the same installation dimensions as the SGMGV Servomotors are also available. Contact your Yaskawa representative for details.

Note: 1. The values in parentheses are for Servomotors with Holding Brakes.

2. The values for a straight, without key specification are given. Refer to the information given below for other shaft end specifications and option specifications.

■ Shaft End Specifications

• Straight with Key and Tap

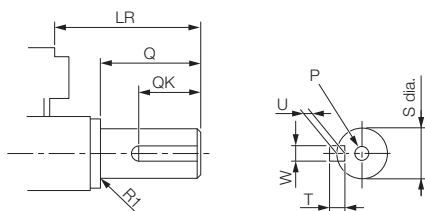

Model SGM7G-	LR	Q	QK	S	W	T	U	P
03A□A61	40*	30*	20*	16 ⁰ _{-0.011} *	5	5	3	M5×12L
05A□A61	40	30	20	16 ⁰ _{-0.011}	5	5	3	

* The shaft end dimensions of these Servomotors are different from those of the Σ-V-series SGMGV Servomotors.

Models that have the same installation dimensions as the SGMGV Servomotors are also available. Contact your Yaskawa representative for details.

■ Connector Specifications

• Encoder Connector (24-bit Encoder)

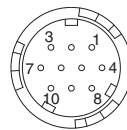

1	PS	6*	BAT(+)
2	/PS	7	-
3	-	8	-
4	PG5V	9	PG0V
5*	BAT(-)	10	FG (frame ground)

* A battery is required only for an absolute encoder.

Receptacle: CM10-R10P-D

Applicable plug: Not provided by Yaskawa.

Plug: CM10-AP10S-□-D for Right-angle Plug

CM10-SP10S-□-D for Straight Plug

(□ depends on the applicable cable size.)

Manufacturer: DDK Ltd.

• Servomotor Connector

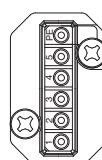

PE	FG (frame ground)	3	Phase U
5	-	2	Phase V
4	-	1	Phase W

Manufacturer: Japan Aviation Electronics Industry, Ltd.

◆ SGM7G-09 to -75

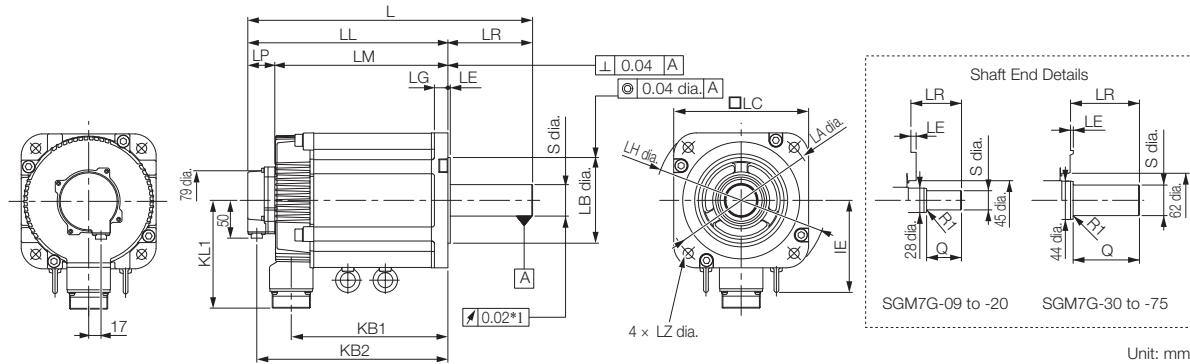

Unit: mm

Model SGM7G-	L* ²	LL* ²	LM	LP* ²	LR	KB1	KB2* ²	IE	KL1	Flange Dimensions						Shaft End Dimensions		Approx. Mass [kg]	
										LA	LB	LC	LE	LG	LH	LZ	S		Q
09A□A21	195	137	101	36	58	83	125	-	104	145	110 ⁰ _{-0.035}	130	6	12	165	9	24 ⁰ _{-0.013} ^{*3}	40	5.5
13A□A21	211	153	117	36	58	99	141	-	104	145	110 ⁰ _{-0.035}	130	6	12	165	9	24 ⁰ _{-0.013} ^{*3}	40	7.1
20A□A21	229	171	135	36	58	117	159	-	104	145	110 ⁰ _{-0.035}	130	6	12	165	9	24 ⁰ _{-0.013}	40	8.6
30A□A21	239	160	124	36	79	108	148	-	134	200	114.3 ⁰ _{-0.025}	180	3.2	18	230	13.5	35 ^{+0.01} ₀	76	13.5
44A□A21	263	184	148	36	79	132	172	-	134	200	114.3 ⁰ _{-0.025}	180	3.2	18	230	13.5	35 ^{+0.01} ₀	76	17.5
55A□A21	334	221	185	36	113	163	209	123	144	200	114.3 ⁰ _{-0.025}	180	3.2	18	230	13.5	42 ⁰ _{-0.016}	110	21.5
75A□A21	380	267	231	36	113	209	255	123	144	200	114.3 ⁰ _{-0.025}	180	3.2	18	230	13.5	42 ⁰ _{-0.016}	110	29.5

*1. This is 0.04 for the SGM7G-55 or SGM7G-75.

*2. For models that have a batteryless absolute encoder, L, LL, LP, and KB2 are 8 mm greater than the given value. Refer to the following section for the values for individual models.

Dimensions of Servomotors with Batteryless Absolute Encoders (page 109)

*3. The S dimensions of these Servomotors are different from those of the Σ-V-series SGMGV Servomotors. Models that have the same installation dimensions as the SGMGV Servomotors are also available. Contact your Yaskawa representative for details.

Note: 1. The values in parentheses are for Servomotors with Holding Brakes.

2. The values for a straight, without key specification are given. Refer to the information given below for other shaft end specifications and option specifications.

■ Shaft End Specifications

• Straight with Key and Tap

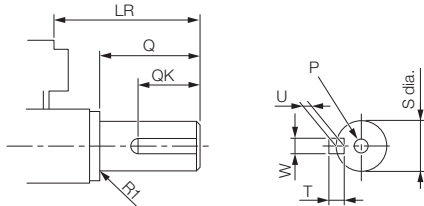

Model SGM7G-	LR	Q	QK	S	W	T	U	P
09A□A61	58	40	25	24 ⁰ _{-0.013} [*]	8*	7*	4*	M5×12L
13A□A61	58	40	25	24 ⁰ _{-0.013} [*]	8*	7*	4*	
20A□A61	58	40	25	24 ⁰ _{-0.013}	8	7	4	
30A□A61	79	76	60	35 ^{+0.01} ₀	10	8	5	M12×25L
44A□A61	79	76	60	35 ^{+0.01} ₀	10	8	5	
55A□A61	113	110	90	42 ⁰ _{-0.016}	12	8	5	M16×32L
75A□A61	113	110	90	42 ⁰ _{-0.016}	12	8	5	

* The shaft end dimensions of these Servomotors are different from those of the Σ-V-series SGMGV Servomotors. Models that have the same installation dimensions as the SGMGV Servomotors are also available. Contact your Yaskawa representative for details.

■ Connector Specifications

• Encoder Connector (24-bit Encoder)

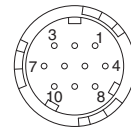

Pin	Signal	Pin	Signal
1	PS	6*	BAT(+)
2	/PS	7	-
3	-	8	-
4	PG5V	9	PG0V
5*	BAT(-)	10	FG (frame ground)

* A battery is required only for an absolute encoder.

Receptacle: CM10-R10P-D

Applicable plug: Not provided by Yaskawa.

Plug: CM10-AP10S-□-D for Right-angle Plug

CM10-SP10S-□-D for Straight Plug

(□ depends on the applicable cable size.)

Manufacturer: DDK Ltd.

• Servomotor Connector

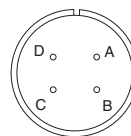

Terminal	Signal	Terminal	Signal
A	Phase U	C	Phase W
B	Phase V	D	FG (frame ground)

Manufacturer: DDK Ltd.

◆ SGM7G-1A and -1E

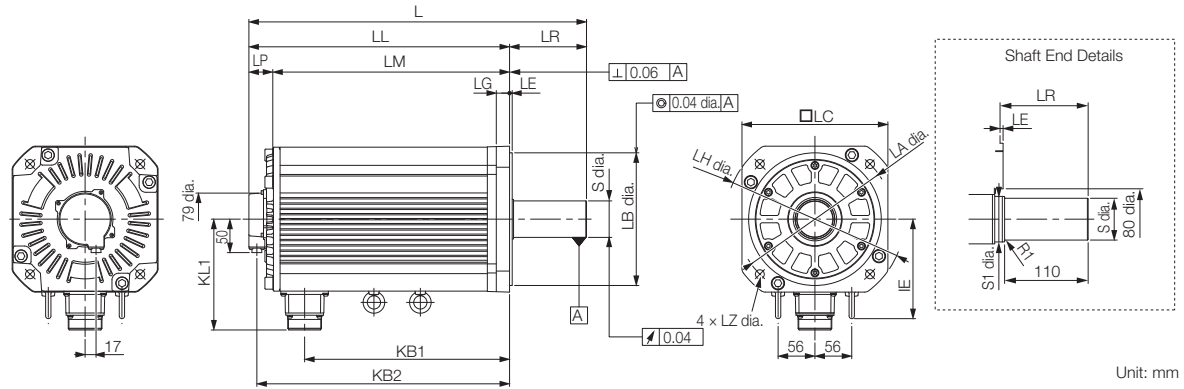

Model SGM7G-	L*	LL*	LM	LP*	LR	KB1	KB2*	IE	KL1	Flange Dimensions						Shaft End Dimensions		Approx. Mass [kg]	
										LA	LB	LC	LE	LG	LH	LZ	S		S1
1AA□A21	447	331	295	36	116	247	319	150	168	235	200 ⁰ _{-0.046}	220	4	20	270	13.5	42 ⁰ _{-0.016}	50	57
1EA□A21	509	393	357	36	116	309	381	150	168	235	200 ⁰ _{-0.046}	220	4	20	270	13.5	55 ^{+0.030} _{+0.011}	60	67

* For models that have a batteryless absolute encoder, L, LL, LP, and KB2 are 8 mm greater than the given value. Refer to the following section for the values for individual models.

📖 *Dimensions of Servomotors with Batteryless Absolute Encoders (page 109)*

Note: 1. The values in parentheses are for Servomotors with Holding Brakes.

2. The values for a straight, without key specification are given. Refer to the information given below for other shaft end specifications and option specifications.

■ Shaft End Specifications

- Straight with Key and Tap

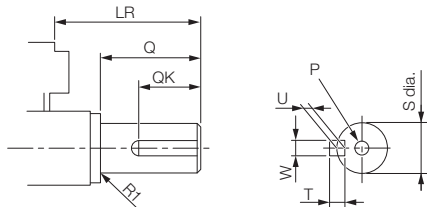

Model SGM7G-	LR	Q	QK	S	W	T	U	P
1AA□A61	116	110	90	42 ⁰ _{-0.016}	12	8	5	M16×32L
1EA□A61	116	110	90	55 ^{+0.030} _{+0.011}	16	10	6	M20×40L

■ Connector Specifications

- Encoder Connector (24-bit Encoder)

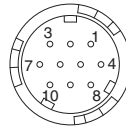

Pin	Signal	Pin	Signal
1	PS	6*	BAT(+)
2	/PS	7	-
3	-	8	-
4	PG5V	9	PG0V
5*	BAT(-)	10	FG (frame ground)

* A battery is required only for an absolute encoder.
Receptacle: CM10-R10P-D
Applicable plug: Not provided by Yaskawa.
Plug: CM10-AP10S-□-D for Right-angle Plug
CM10-SP10S-□-D for Straight Plug
(□ depends on the applicable cable size.)
Manufacturer: DDK Ltd.

- Servomotor Connector

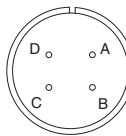

Pin	Signal	Pin	Signal
A	Phase U	C	Phase W
B	Phase V	D	FG (frame ground)

Manufacturer: DDK Ltd.

Servomotors with Holding Brakes

◆ SGM7G-03 and -05

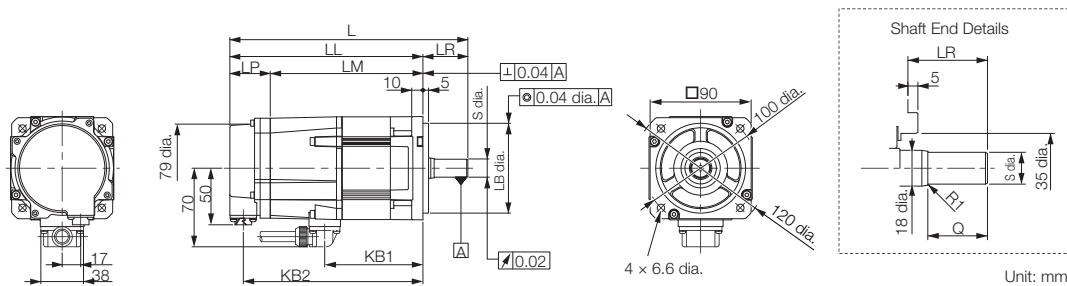

Model SGM7G-	L*1	LL*1	LM	LP*1	LR	KB1	KB2*1	KL1
03A□A2C	199*2	159	123	36	40*2	75	147	70
05A□A2C	212	172	136	36	40	88	160	70

Model SGM7G-	Flange Dimensions							Shaft End Dimensions		Approx. Mass [kg]
	LA	LB	LC	LE	LG	LH	LZ	S	Q	
03A□A2C	100	80 ⁰ _{-0.030}	90	5	10	120	6.6	16 ⁰ _{-0.011} *2	30*2	3.6
05A□A2C	100	80 ⁰ _{-0.030}	90	5	10	120	6.6	16 ⁰ _{-0.011}	30	4.2

*1. For models that have a batteryless absolute encoder, L, LL, LP, and KB2 are 8 mm greater than the given value. Refer to the following section for the values for individual models.

Dimensions of Servomotors with Batteryless Absolute Encoders (page 109)

*2. The L, LR, S, and Q dimensions of these Servomotors are different from those of the Σ-V-series SGMGV Servomotors.

Models that have the same installation dimensions as the SGMGV Servomotors are also available. Contact your Yaskawa representative for details.

Note: 1. The values in parentheses are for Servomotors with Holding Brakes.

2. The values for a straight, without key specification are given. Refer to the information given below for other shaft end specifications and option specifications.

■ Shaft End Specifications

• Straight with Key and Tap

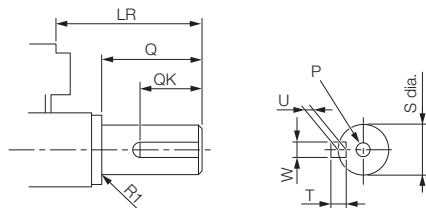

Model SGM7G-	LR	Q	QK	S	W	T	U	P
03A□A6C	40*	30*	20*	16 ⁰ _{-0.011} *	5	5	3	M5×12L
05A□A6C	40	30	20	16 ⁰ _{-0.011}	5	5	3	

* The shaft end dimensions of these Servomotors are different from those of the Σ-V-series SGMGV Servomotors.

Models that have the same installation dimensions as the SGMGV Servomotors are also available. Contact your Yaskawa representative for details.

■ Connector Specifications

• Encoder Connector (24-bit Encoder)

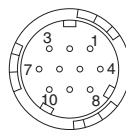

1	PS	6*	BAT(+)
2	/PS	7	-
3	-	8	-
4	PG5V	9	PG0V
5*	BAT(-)	10	FG (frame ground)

* A battery is required only for an absolute encoder.

Receptacle: CM10-R10P-D

Applicable plug: Not provided by Yaskawa.

Plug: CM10-AP10S-□-D for Right-angle Plug
CM10-SP10S-□-D for Straight Plug

(□ depends on the applicable cable size.)

Manufacturer: DDK Ltd.

• Servomotor Connector

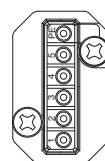

PE	FG (frame ground)	3	Phase U
5	-	2	Phase V
4	-	1	Phase W

Manufacturer: Japan Aviation Electronics Industry, Ltd.

◆ SGM7G-09 to -75

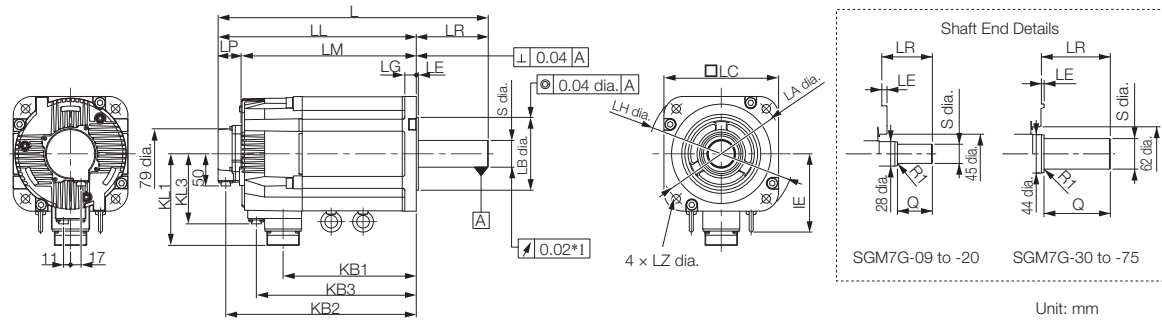

Model SGM7G-	L ^{*2}	LL ^{*2}	LM	LP ^{*2}	LR	KB1	KB2 ^{*2}	KB3	IE	KL1	KL3	Flange Dimensions						Shaft End Dimensions		Approx. Mass [kg]	
												LA	LB	LC	LE	LG	LH	LZ	S		Q
09A□A2C	231	173	137	36	58	83	161	115	-	104	80	145	110 ⁰ _{-0.035}	130	6	12	165	9	24 ⁰ _{-0.013} ^{*3}	40	7.5
13A□A2C	247	189	153	36	58	99	177	131	-	104	80	145	110 ⁰ _{-0.035}	130	6	12	165	9	24 ⁰ _{-0.013} ^{*3}	40	9.0
20A□A2C	265	207	171	36	58	117	195	149	-	104	80	145	110 ⁰ _{-0.035}	130	6	12	165	9	24 ⁰ _{-0.013}	40	11.0
30A□A2C	287	208	172	36	79	108	196	148	-	134	110	200	114.3 ⁰ _{-0.025}	180	3.2	18	230	13.5	35 ^{+0.01} ₀	76	19.5
44A□A2C	311	232	196	36	79	132	220	172	-	134	110	200	114.3 ⁰ _{-0.025}	180	3.2	18	230	13.5	35 ^{+0.01} ₀	76	23.5
55A□A2C	378	265	229	36	113	163	253	205	123	144	110	200	114.3 ⁰ _{-0.025}	180	3.2	18	230	13.5	42 ⁰ _{-0.016}	110	27.5
75A□A2C	424	311	275	36	113	209	299	251	123	144	110	200	114.3 ⁰ _{-0.025}	180	3.2	18	230	13.5	42 ⁰ _{-0.016}	110	35.0

- *1. This is 0.04 for the SGM7G-55 or SGM7G-75.
- *2. For models that have a batteryless absolute encoder, L, LL, LP, and KB2 are 8 mm greater than the given value. Refer to the following section for the values for individual models.
Dimensions of Servomotors with Batteryless Absolute Encoders (page 109)
- *3. The S dimensions of these Servomotors are different from those of the Σ-V-series SGMGV Servomotors. Models that have the same installation dimensions as the SGMGV Servomotors are also available. Contact your Yaskawa representative for details.

Note: 1. The values in parentheses are for Servomotors with Holding Brakes.
 2. The values for a straight, without key specification are given. Refer to the information given below for other shaft end specifications and option specifications.

■ Shaft End Specifications

• Straight with Key and Tap

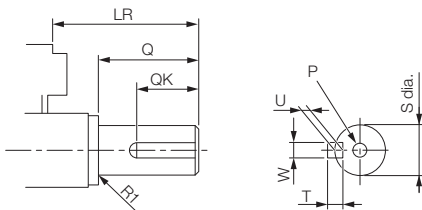

Model SGM7G-	LR	Q	QK	S	W	T	U	P
09A□A6C	58	40	25	24 ⁰ _{-0.013} [*]	8*	7*	4*	M5×12L
13A□A6C	58	40	25	24 ⁰ _{-0.013} [*]	8*	7*	4*	
20A□A6C	58	40	25	24 ⁰ _{-0.013}	8	7	4	
30A□A6C	79	76	60	35 ^{+0.01} ₀	10	8	5	M12×25L
44A□A6C	79	76	60	35 ^{+0.01} ₀	10	8	5	
55A□A6C	113	110	90	42 ⁰ _{-0.016}	12	8	5	M16×32L
75A□A6C	113	110	90	42 ⁰ _{-0.016}	12	8	5	

* The shaft end dimensions of these Servomotors are different from those of the Σ-V-series SGMGV Servomotors. Models that have the same installation dimensions as the SGMGV Servomotors are also available. Contact your Yaskawa representative for details.

■ Connector Specifications

• Encoder Connector (24-bit Encoder)

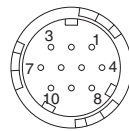

Pin	Signal	Pin	Signal
1	PS	6*	BAT(+)
2	/PS	7	-
3	-	8	-
4	PG5V	9	PG0V
5*	BAT(-)	10	FG (frame ground)

* A battery is required only for an absolute encoder.
 Receptacle: CM10-R10P-D
 Applicable plug: Not provided by Yaskawa.
 Plug: CM10-AP10S-□-D for Right-angle Plug
 CM10-SP10S-□-D for Straight Plug
 (□ depends on the applicable cable size.)
 Manufacturer: DDK Ltd.

• Servomotor Connector

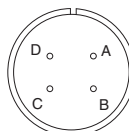

Terminal	Signal	Terminal	Signal
A	Phase U	C	Phase W
B	Phase V	D	FG (frame ground)

Manufacturer: DDK Ltd.

• Brake Connector

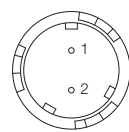

Pin	Signal
1	Brake terminal
2	Brake terminal

Note: There is no voltage polarity for the brake terminals.
 Receptacle: CM10-R10P-D
 Applicable plug: Not provided by Yaskawa.
 Plug: CM10-AP2S-□-D for Right-angle Plug
 CM10-SP2S-□-D for Straight Plug
 (□ depends on the applicable cable size.)
 Manufacturer: DDK Ltd.

◆ SGM7G-1A, 1E

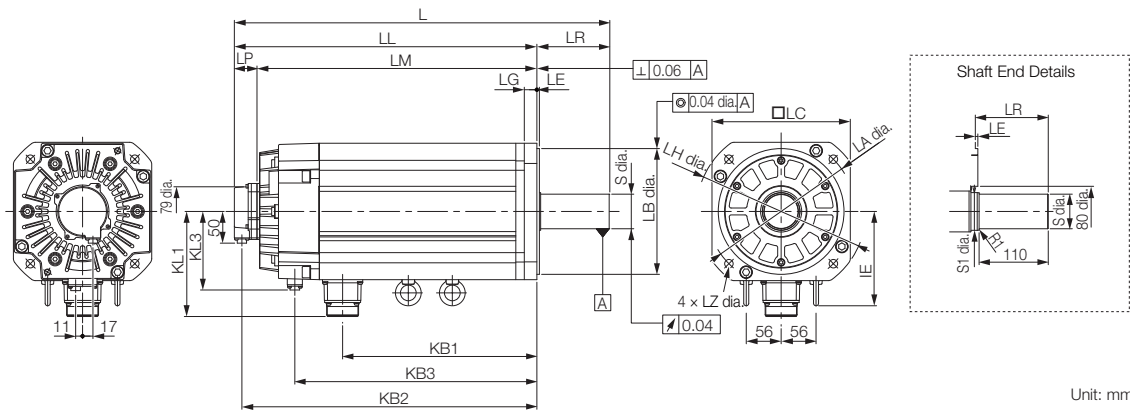

Unit: mm

Model SGM7G-	L*	LL*	LM	LP*	LR	KB1	KB2*	KB3	IE	KL1	KL3	Flange Dimensions						Shaft End Dimensions		Approx. Mass [kg]	
												LA	LB	LC	LE	LG	LH	LZ	S		S1
1AA□A2C	498	382	346	36	116	247	370	315	150	168	125	235	200 ⁰ _{-0.046}	220	4	20	270	13.5	42 ⁰ _{-0.016}	50	65
1EA□A2C	598	482	446	36	116	309	470	385	150	168	125	235	200 ⁰ _{-0.046}	220	4	20	270	13.5	55 ^{+0.030} _{+0.011}	60	85

* For models that have a batteryless absolute encoder, L, LL, LP, and KB2 are 8 mm greater than the given value. Refer to the following section for the values for individual models.

📖 **Dimensions of Servomotors with Batteryless Absolute Encoders (page 109)**

Note: 1. The values in parentheses are for Servomotors with Holding Brakes.

2. The values for a straight, without key specification are given. Refer to the information given below for other shaft end specifications and option specifications.

■ Shaft End Specifications

• Straight with Key and Tap

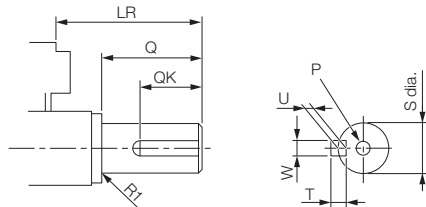

Model SGM7G-	LR	Q	QK	S	W	T	U	P
1AA□A6C	116	110	90	42 ⁰ _{-0.016}	12	8	5	M16×32L
1EA□A6C	116	110	90	55 ^{+0.030} _{+0.011}	16	10	6	M20×40L

■ Connector Specifications

• Encoder Connector (24-bit Encoder)

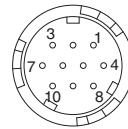

Terminal	Signal	Terminal	Signal
1	PS	6*	BAT(+)
2	/PS	7	-
3	-	8	-
4	PG5V	9	PG0V
5*	BAT(-)	10	FG (frame ground)

* A battery is required only for an absolute encoder.

Receptacle: CM10-R10P-D

Applicable plug: Not provided by Yaskawa.

Plug: CM10-AP10S-□-D for Right-angle Plug

CM10-SP10S-□-D for Straight Plug

(□ depends on the applicable cable size.)

Manufacturer: DDK Ltd.

• Servomotor Connector

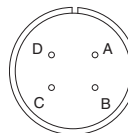

Terminal	Signal	Terminal	Signal
A	Phase U	C	Phase W
B	Phase V	D	FG (frame ground)

Manufacturer: DDK Ltd.

• Brake Connector

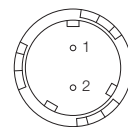

Terminal	Signal
1	Brake terminal
2	Brake terminal

Note: There is no voltage polarity for the brake terminals.

Receptacle: CM10-R10P-D

Applicable plug: Not provided by Yaskawa.

Plug: CM10-AP2S-□-D for Right-angle Plug

CM10-SP2S-□-D for Straight Plug

(□ depends on the applicable cable size.)

Manufacturer: DDK Ltd.

Dimensions of Servomotors with Batteryless Absolute Encoders

◆ Servomotors without Holding Brakes

Model SGM7G-	L	LL	LP	KB2	Approx. Mass [kg]
03A6A21	174	134	44	122	2.6
05A6A21	187	147	44	135	3.2
09A6A21	203	145	44	133	5.5
13A6A21	219	161	44	149	7.1
20A6A21	237	179	44	167	8.6
30A6A21	247	168	44	156	13.5
44A6A21	271	192	44	180	17.5
55A6A21	342	229	44	217	21.5
75A6A21	388	275	44	263	29.5
1AA6A21	455	339	44	327	57
1EA6A21	514	401	44	389	67

◆ Servomotors with Holding Brakes

Model SGM7G-	L	LL	LP	KB2	Approx. Mass [kg]
03A6A2C	207	167	44	155	3.6
05A6A2C	220	180	44	168	4.2
09A6A2C	239	181	44	169	7.5
13A6A2C	255	197	44	185	9.0
20A6A2C	273	215	44	203	11
30A6A2C	295	216	44	204	19.5
44A6A2C	319	240	44	228	23.5
55A6A2C	386	273	44	261	27.5
75A6A2C	432	319	44	307	35.0
1AA6A2C	506	390	44	378	65
1EA6A2C	606	490	44	478	85

Selecting Cables

◆ Cable Configurations

The cables shown below are required to connect a Servomotor to a SERVOPACK.

Encoder Cable of 20 m or Less

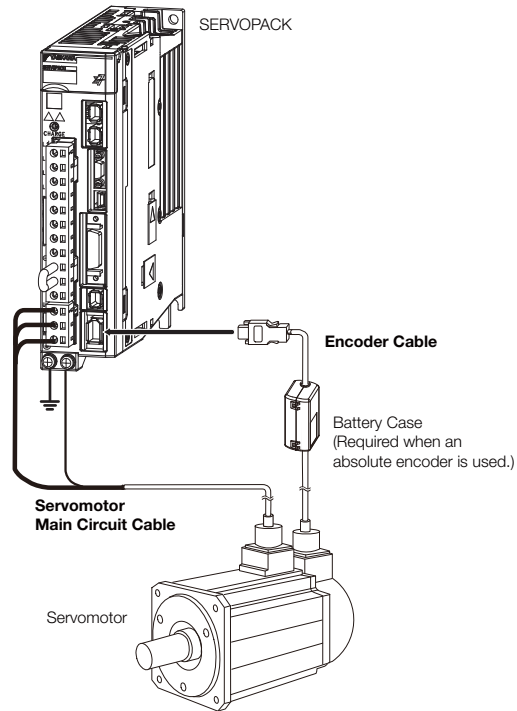

Encoder Cable of 30 m to 50 m (Relay Cable)

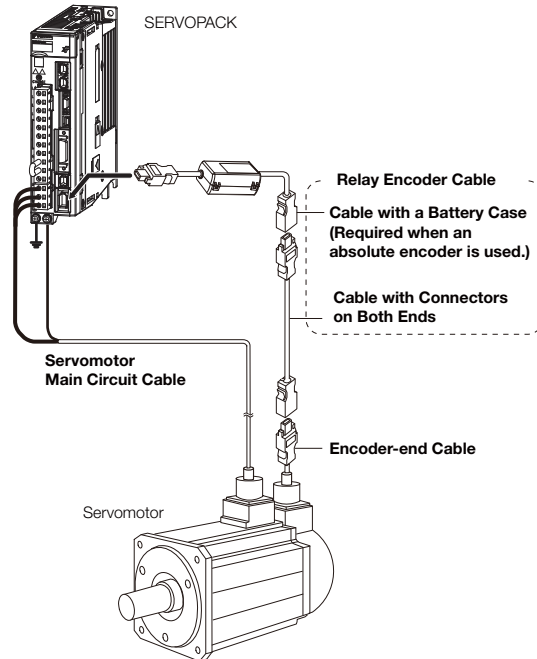

Note: 1. Cables with connectors on both ends that are compliant with an IP67 protective structure and European Safety Standards are not available from Yaskawa for the SGM7G Servomotors. You must make such a cable yourself. Use the Connectors specified by Yaskawa for these Servomotors. (These Connectors are compliant with the standards.) Yaskawa does not specify what wiring materials to use.

2. If the Encoder Cable length exceeds 20 m, be sure to use a Relay Encoder Cable.

3. If you use a Servomotor Main Circuit Cable that exceeds 20 m, the intermittent duty zone in the torque-motor speed characteristics will become smaller because the voltage drop increases.

4. Refer to the following manual for the following information.

- Cable dimensional drawings and cable connection specifications
- Order numbers and specifications of individual connectors for cables
- Order numbers and specifications for wiring materials

📖 *Σ-7-Series AC Servo Drive Peripheral Device Selection Manual (Manual No.: SIEP S800001 32)*

◆ Servomotor Main Circuit Cables

Servomotor Model	Name	Length (L)	Order Number*	Appearance
SGM7G-03 and -05 300 W, 450 W	For Servomotors without Holding Brakes	3 m	JZSP-CVM21-03-E	
		5 m	JZSP-CVM21-05-E	
		10 m	JZSP-CVM21-10-E	
		15 m	JZSP-CVM21-15-E	
		20 m	JZSP-CVM21-20-E	
		30 m	JZSP-CVM21-30-E	
		40 m	JZSP-CVM21-40-E	
		50 m	JZSP-CVM21-50-E	
	For Servomotors with Holding Brakes	3 m	JZSP-CVM41-03-E	
		5 m	JZSP-CVM41-05-E	
		10 m	JZSP-CVM41-10-E	
		15 m	JZSP-CVM41-15-E	
		20 m	JZSP-CVM41-20-E	
		50 m	JZSP-CVM41-50-E	

* Use Flexible Cables for moving parts of machines, such as robots. The recommended bending radius (R) is 90 mm or larger.

Servomotor Model	Name	Connector Specifications	Length (L)	Order Number		Appearance
				Standard Cable	Flexible Cable*1	
SGM7G-09 and -13 850 W, 1.3 kW	For Servomotors without Holding Brakes	Straight	3 m	JZSP-UVA101-03-E	JZSP-UVA121-03-E	
			5 m	JZSP-UVA101-05-E	JZSP-UVA121-05-E	
			10 m	JZSP-UVA101-10-E	JZSP-UVA121-10-E	
			15 m	JZSP-UVA101-15-E	JZSP-UVA121-15-E	
		Right-angle	3 m	JZSP-UVA102-03-E	JZSP-UVA122-03-E	
			5 m	JZSP-UVA102-05-E	JZSP-UVA122-05-E	
			10 m	JZSP-UVA102-10-E	JZSP-UVA122-10-E	
			15 m	JZSP-UVA102-15-E	JZSP-UVA122-15-E	
	For Servomotors with Holding Brakes	Straight	3 m	JZSP-UVA131-03-E	JZSP-UVA141-03-E	
			5 m	JZSP-UVA131-05-E	JZSP-UVA141-05-E	
			10 m	JZSP-UVA131-10-E	JZSP-UVA141-10-E	
		Right-angle	15 m	JZSP-UVA131-15-E	JZSP-UVA141-15-E	
			20 m	JZSP-UVA131-20-E	JZSP-UVA141-20-E	
			3 m	JZSP-UVA132-03-E	JZSP-UVA142-03-E	
5 m	JZSP-UVA132-05-E	JZSP-UVA142-05-E				
10 m	JZSP-UVA132-10-E	JZSP-UVA142-10-E				
(Set of Two Cables*2)	Right-angle	15 m	JZSP-UVA132-15-E	JZSP-UVA142-15-E		
		20 m	JZSP-UVA132-20-E	JZSP-UVA142-20-E		

*1. Use Flexible Cables for moving parts of machines, such as robots. The recommended bending radius (R) is 90 mm or larger.

*2. This order number is for a set of two cables (Main Power Supply Cable and Holding Brake Cable). When you purchase them separately, the order numbers for Main Power Supply Cables are the same as for a Servomotor without a Holding Brake.

The following order numbers are for a Holding Brake Cable. These Standard Cables are Flexible Cables.

- Cable with Straight Plug: JZSP-U7B23-□□-E
- Cable with Right-angle Plug: JZSP-U7B24-□□-E

Rotary Servomotors
SGM7G

Servo-motor Model	Name	Connector Specifications	Length (L)	Order Number		Appearance
				Standard Cable	Flexible Cable* ¹	
SGM7G-20 1.8 kW	For Servomotors without Holding Brakes	Straight	3 m	JZSP-UVA301-03-E	JZSP-UVA321-03-E	
			5 m	JZSP-UVA301-05-E	JZSP-UVA321-05-E	
			10 m	JZSP-UVA301-10-E	JZSP-UVA321-10-E	
			15 m	JZSP-UVA301-15-E	JZSP-UVA321-15-E	
		Right-angle	3 m	JZSP-UVA302-03-E	JZSP-UVA322-03-E	
			5 m	JZSP-UVA302-05-E	JZSP-UVA322-05-E	
			10 m	JZSP-UVA302-10-E	JZSP-UVA322-10-E	
			15 m	JZSP-UVA302-15-E	JZSP-UVA322-15-E	
	For Servomotors with Holding Brakes (Set of Two Cables* ²)	Straight	3 m	JZSP-UVA331-03-E	JZSP-UVA341-03-E	
			5 m	JZSP-UVA331-05-E	JZSP-UVA341-05-E	
			10 m	JZSP-UVA331-10-E	JZSP-UVA341-10-E	
			15 m	JZSP-UVA331-15-E	JZSP-UVA341-15-E	
		Right-angle	3 m	JZSP-UVA332-03-E	JZSP-UVA342-03-E	
			5 m	JZSP-UVA332-05-E	JZSP-UVA342-05-E	
			10 m	JZSP-UVA332-10-E	JZSP-UVA342-10-E	
			15 m	JZSP-UVA332-15-E	JZSP-UVA342-15-E	
SGM7G-30 2.4 kW (When using an SGD7S-200A SERVO-PACK.)	For Servomotors without Holding Brakes	Straight	3 m	JZSP-UVA601-03-E	JZSP-UVA621-03-E	
			5 m	JZSP-UVA601-05-E	JZSP-UVA621-05-E	
			10 m	JZSP-UVA601-10-E	JZSP-UVA621-10-E	
			15 m	JZSP-UVA601-15-E	JZSP-UVA621-15-E	
		Right-angle	3 m	JZSP-UVA602-03-E	JZSP-UVA622-03-E	
			5 m	JZSP-UVA602-05-E	JZSP-UVA622-05-E	
			10 m	JZSP-UVA602-10-E	JZSP-UVA622-10-E	
			15 m	JZSP-UVA602-15-E	JZSP-UVA622-15-E	
	For Servomotors with Holding Brakes (Set of Two Cables* ²)	Straight	3 m	JZSP-UVA631-03-E	JZSP-UVA641-03-E	
			5 m	JZSP-UVA631-05-E	JZSP-UVA641-05-E	
			10 m	JZSP-UVA631-10-E	JZSP-UVA641-10-E	
			15 m	JZSP-UVA631-15-E	JZSP-UVA641-15-E	
		Right-angle	3 m	JZSP-UVA632-03-E	JZSP-UVA642-03-E	
			5 m	JZSP-UVA632-05-E	JZSP-UVA642-05-E	
			10 m	JZSP-UVA632-10-E	JZSP-UVA642-10-E	
			15 m	JZSP-UVA632-15-E	JZSP-UVA642-15-E	







*1. Use Flexible Cables for moving parts of machines, such as robots. The recommended bending radius (R) is 90 mm or larger.

*2. This order number is for a set of two cables (Main Power Supply Cable and Holding Brake Cable). When you purchase them separately, the order numbers for Main Power Supply Cables are the same as for a Servomotor without a Holding Brake.

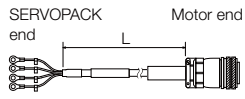
The following order numbers are for a Holding Brake Cable. These Standard Cables are Flexible Cables.

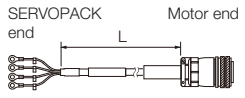
- Cable with Straight Plug: JZSP-U7B23-□□-E
- Cable with Right-angle Plug: JZSP-U7B24-□□-E

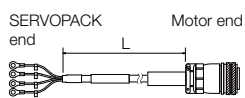
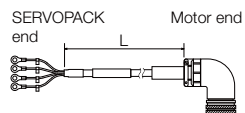
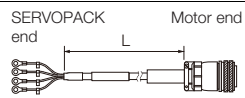
Note: If you need a Cable with a length of 20 m to 50 m, consider the operating conditions and specify a suitable length.

Servo-motor Model	Name	Connector Specifications	Length (L)	Order Number		Appearance
				Standard Cable	Flexible Cable*1	
SGM7G-30 and -44	For Servomotors without Holding Brakes	Straight	3 m	JZSP-UVA701-03-E	JZSP-UVA721-03-E	
			5 m	JZSP-UVA701-05-E	JZSP-UVA721-05-E	
			10 m	JZSP-UVA701-10-E	JZSP-UVA721-10-E	
			15 m	JZSP-UVA701-15-E	JZSP-UVA721-15-E	
			20 m	JZSP-UVA701-20-E	JZSP-UVA721-20-E	
		Right-angle	3 m	JZSP-UVA702-03-E	JZSP-UVA722-03-E	
			5 m	JZSP-UVA702-05-E	JZSP-UVA722-05-E	
			10 m	JZSP-UVA702-10-E	JZSP-UVA722-10-E	
			15 m	JZSP-UVA702-15-E	JZSP-UVA722-15-E	
			20 m	JZSP-UVA702-20-E	JZSP-UVA722-20-E	
2.9 kW, 4.4 kW	For Servomotors with Holding Brakes	Straight	3 m	JZSP-UVA731-03-E	JZSP-UVA741-03-E	
			5 m	JZSP-UVA731-05-E	JZSP-UVA741-05-E	
			10 m	JZSP-UVA731-10-E	JZSP-UVA741-10-E	
			15 m	JZSP-UVA731-15-E	JZSP-UVA741-15-E	
			20 m	JZSP-UVA731-20-E	JZSP-UVA741-20-E	
	(Set of Two Cables*2)	Right-angle	3 m	JZSP-UVA732-03-E	JZSP-UVA742-03-E	
			5 m	JZSP-UVA732-05-E	JZSP-UVA742-05-E	
			10 m	JZSP-UVA732-10-E	JZSP-UVA742-10-E	
			15 m	JZSP-UVA732-15-E	JZSP-UVA742-15-E	
			20 m	JZSP-UVA732-20-E	JZSP-UVA742-20-E	
SGM7G-55 and -75	For Servomotors without Holding Brakes	Straight	3 m	JZSP-UVAA01-03-E	JZSP-UVAA21-03-E	
			5 m	JZSP-UVAA01-05-E	JZSP-UVAA21-05-E	
			10 m	JZSP-UVAA01-10-E	JZSP-UVAA21-10-E	
			15 m	JZSP-UVAA01-15-E	JZSP-UVAA21-15-E	
			20 m	JZSP-UVAA01-20-E	JZSP-UVAA21-20-E	
		Right-angle	3 m	JZSP-UVAA02-03-E	JZSP-UVAA22-03-E	
			5 m	JZSP-UVAA02-05-E	JZSP-UVAA22-05-E	
			10 m	JZSP-UVAA02-10-E	JZSP-UVAA22-10-E	
			15 m	JZSP-UVAA02-15-E	JZSP-UVAA22-15-E	
			20 m	JZSP-UVAA02-20-E	JZSP-UVAA22-20-E	
5.5 kW, 7.5 kW	For Servomotors with Holding Brakes	Straight	3 m	JZSP-UVAA31-03-E	JZSP-UVAA41-03-E	
			5 m	JZSP-UVAA31-05-E	JZSP-UVAA41-05-E	
			10 m	JZSP-UVAA31-10-E	JZSP-UVAA41-10-E	
			15 m	JZSP-UVAA31-15-E	JZSP-UVAA41-15-E	
			20 m	JZSP-UVAA31-20-E	JZSP-UVAA41-20-E	
	(Set of Two Cables*2)	Right-angle	3 m	JZSP-UVAA32-03-E	JZSP-UVAA42-03-E	
			5 m	JZSP-UVAA32-05-E	JZSP-UVAA42-05-E	
			10 m	JZSP-UVAA32-10-E	JZSP-UVAA42-10-E	
			15 m	JZSP-UVAA32-15-E	JZSP-UVAA42-15-E	
			20 m	JZSP-UVAA32-20-E	JZSP-UVAA42-20-E	

*1. Use Flexible Cables for moving parts of machines, such as robots. The recommended bending radius (R) is 90 mm or larger.

*2. This order number is for a set of two cables (Main Power Supply Cable and Holding Brake Cable). When you purchase them separately, the order numbers for Main Power Supply Cables are the same as for a Servomotor without a Holding Brake. The following order numbers are for a Holding Brake Cable. These Standard Cables are Flexible Cables.

- Cable with Straight Plug: JZSP-U7B23-□□-E
- Cable with Right-angle Plug: JZSP-U7B24-□□-E

Note: If you need a Cable with a length of 20 m to 50 m, consider the operating conditions and specify a suitable length.

Rotary Servomotors
SGM7G

Servo-motor Model	Name	Connector Specifications	Length (L)	Order Number		Appearance
				Standard Cable	Flexible Cable * ¹	
SGM7G-1A and -1E 11 kW, 15 kW	For Servomotors without Holding Brakes	Straight	3 m	JZSP-UVAB01-03-E	JZSP-UVAB21-03-E	
			5 m	JZSP-UVAB01-05-E	JZSP-UVAB21-05-E	
			10 m	JZSP-UVAB01-10-E	JZSP-UVAB21-10-E	
			15 m	JZSP-UVAB01-15-E	JZSP-UVAB21-15-E	
			20 m	JZSP-UVAB01-20-E	JZSP-UVAB21-20-E	
		Right-angle	3 m	JZSP-UVAB02-03-E	JZSP-UVAB22-03-E	
			5 m	JZSP-UVAB02-05-E	JZSP-UVAB22-05-E	
			10 m	JZSP-UVAB02-10-E	JZSP-UVAB22-10-E	
			15 m	JZSP-UVAB02-15-E	JZSP-UVAB22-15-E	
			20 m	JZSP-UVAB02-20-E	JZSP-UVAB22-20-E	
	For Servomotors with Holding Brakes (Set of Two Cables* ²)	Straight	3 m	JZSP-UVAB31-03-E	JZSP-UVAB41-03-E	
			5 m	JZSP-UVAB31-05-E	JZSP-UVAB41-05-E	
			10 m	JZSP-UVAB31-10-E	JZSP-UVAB41-10-E	
			15 m	JZSP-UVAB31-15-E	JZSP-UVAB41-15-E	
			20 m	JZSP-UVAB31-20-E	JZSP-UVAB41-20-E	
Right-angle		3 m	JZSP-UVAB32-03-E	JZSP-UVAB42-03-E		
		5 m	JZSP-UVAB32-05-E	JZSP-UVAB42-05-E		
		10 m	JZSP-UVAB32-10-E	JZSP-UVAB42-10-E		
		15 m	JZSP-UVAB32-15-E	JZSP-UVAB42-15-E		
		20 m	JZSP-UVAB32-20-E	JZSP-UVAB42-20-E		

*1. Use Flexible Cables for moving parts of machines, such as robots. The recommended bending radius (R) is 90 mm or larger.

*2. This order number is for a set of two cables (Main Power Supply Cable and Holding Brake Cable).

When you purchase them separately, the order numbers for Main Power Supply Cables are the same as for a Servomotor without a Holding Brake.

The following order numbers are for a Holding Brake Cable. These Standard Cables are Flexible Cables.

- Cable with Straight Plug: JZSP-U7B23-□□-E
- Cable with Right-angle Plug: JZSP-U7B24-□□-E

Note: If you need a Cable with a length of 20 m to 50 m, consider the operating conditions and specify a suitable length.

◆ Encoder Cables of 20 m or Less

Servomotor Model	Name	Length (L)	Order Number		Appearance	
			Standard Cable	Flexible Cable* ¹		
All SGM7G models	For incremental encoder, or batteryless absolute encoder	3 m	JZSP-CVP01-03-E	JZSP-CVP11-03-E		
		5 m	JZSP-CVP01-05-E	JZSP-CVP11-05-E		
		10 m	JZSP-CVP01-10-E	JZSP-CVP11-10-E		
		15 m	JZSP-CVP01-15-E	JZSP-CVP11-15-E		
		20 m	JZSP-CVP01-20-E	JZSP-CVP11-20-E		
		3 m	JZSP-CVP02-03-E	JZSP-CVP12-03-E		
		5 m	JZSP-CVP02-05-E	JZSP-CVP12-05-E		
		10 m	JZSP-CVP02-10-E	JZSP-CVP12-10-E		
		15 m	JZSP-CVP02-15-E	JZSP-CVP12-15-E		
		20 m	JZSP-CVP02-20-E	JZSP-CVP12-20-E		
	For absolute encoder: With Battery Case* ²	3 m	JZSP-CVP06-03-E	JZSP-CVP26-03-E		
		5 m	JZSP-CVP06-05-E	JZSP-CVP26-05-E		
		10 m	JZSP-CVP06-10-E	JZSP-CVP26-10-E		
		15 m	JZSP-CVP06-15-E	JZSP-CVP26-15-E		
		20 m	JZSP-CVP06-20-E	JZSP-CVP26-20-E		
		3 m	JZSP-CVP07-03-E	JZSP-CVP27-03-E		
		5 m	JZSP-CVP07-05-E	JZSP-CVP27-05-E		
		10 m	JZSP-CVP07-10-E	JZSP-CVP27-10-E		
15 m	JZSP-CVP07-15-E	JZSP-CVP27-15-E				
		20 m	JZSP-CVP07-20-E	JZSP-CVP27-20-E		

*1. Use Flexible Cables for moving parts of machines, such as robots. The recommended bending radius (R) is 90 mm or larger.

*2. If a battery is connected to the host controller, the Battery Case is not required. If so, use a cable for incremental encoders.

◆ Relay Encoder Cables of 30 m to 50 m

Servomotor Model	Name	Length (L)	Order Number for Standard Cable	Appearance
All SGM7G models	Encoder-end Cable (for all types of encoders)	0.3 m	JZSP-CVP01-E	
			JZSP-CVP02-E	
	Cables with Connectors on Both Ends (for all types of encoders)	30 m	JZSP-UCMP00-30-E	
		40 m	JZSP-UCMP00-40-E	
		50 m	JZSP-UCMP00-50-E	
	Cable with a Battery Case (Required when an absolute encoder is used,)*	0.3 m	JZSP-CSP12-E	

* This Cable is not required if you use a Servomotor with a Batteryless Absolute Encoder, and you connect a battery to the host controller.

MEMO

Direct Drive Servomotors

■ Features



SGM7D (With Core, Outer Rotor) 118

- Ideal for applications that require high torque, high precision, and high rigidity.
- Application to large loads possible with a high allowable load moment of inertia ratio.
- Highly accurate indexing can be achieved with a high-resolution 24-bit encoder.
- High rigidity.
- Large center aperture design to save wiring space.



SGM7E (Coreless, Inner Rotor) 144

- Ideal for applications that require smooth movement without speed fluctuations.
- Low cogging with a core-less system provides smooth operation free from speed variations.
- Highly accurate indexing can be achieved with a high-resolution 24-bit encoder.
- High machine precision for runout at end of shaft and runout of shaft surface (0.01 mm).



SGM7F (With Core, Inner Rotor) 160

- Ideal for applications that require downsizing and a shorter takt time.
- High-speed, high-frequency positioning.
- Low heat generation.
- Highly accurate indexing can be achieved with a high-resolution 24-bit encoder.
- High machine precision for runout at end of shaft and runout of shaft surface (0.01 mm).



SGM7C (Small Capacity, with Core, Inner Rotor) 182

- Compact design with small rotor diameter.
- Low inertia, low heat generation.
- High-speed, high-frequency positioning.
- High machine precision for runout at end of shaft and runout of shaft surface (0.01 mm).
- Built-in 22-bit encoder.



SGM7S (Small Capacity, Coreless, Inner Rotor or Medium Capacity, with Core, Inner Rotor)..... 196

- High-speed operation can shorten takt time.
- Built-in 20-bit encoder.

SGM7D

SGM7E

SGM7F

SGM7C

SGM7S

SGM7D (With Core, Outer Rotor)

Model Designations

SGM7D - 30 F 7 C 4 1

Direct Drive Servomotors: SGM7D

1st+2nd digits

3rd digit

4th digit

5th digit

6th digit

7th digit

1st+2nd digits Rated Torque

Code	Specification	Code	Specification	Code	Specification
01	1.30 N·m	18	18.0 N·m	58	58.0 N·m
02	2.06 N·m	20	20.0 N·m	70	70.0 N·m
03	3.00 N·m	24	24.0 N·m	90	90.0 N·m
05	5.00 N·m	28	28.0 N·m	1Z	100 N·m
06	6.00 N·m	30	30.0 N·m	1A	110 N·m
08	8.00 N·m	34	34.0 N·m	1C	130 N·m
09	9.00 N·m	38	38.0 N·m	2B	220 N·m
12	12.0 N·m	45	45.0 N·m	2D	240 N·m

3rd digit Servomotor Outer Diameter

Code	Specification	Code	Specification
F	264-mm dia.	J	150-mm dia.
G	160-mm dia.	K	107-mm dia.
H	116-mm dia.	L	224 mm × 224 mm
I	264-mm dia.		

- Note: 1. Direct Drive Servomotors are not available with holding brakes.
2. This information is provided to explain model numbers. It is not meant to imply that models are available for all combinations of codes.

4th digit Serial Encoder

Code	Specification
7	24-bit multiturn absolute encoder*
F	24-bit incremental encoder*

* Both multiturn absolute encoder and incremental encoder can be used as a single-turn absolute encoder by setting parameters.

5th digit Design Revision Order

C

6th digit Flange

Code	Mounting	Servomotor Outer Diameter Code (3rd Digit)						
		F	G	H	I	J	K	L
4	Non-load side							
	With cable on side	✓	✓	✓	-	-	-	✓
5	Non-load side							
	With cable on bottom	✓	✓*	-	✓	✓	✓	-

✓: Applicable models.

* SGM7D-01G and -05G are not available with a cable extending from the bottom.

7th digit Options

Code	Specification
1	Standard mechanical precision
2	High mechanical precision*

* The SGM7D-01G, -05G, and -03H are available only with high mechanical precision.

◆ Manufactured Models

Rated Torque N·m	Servomotor Outer Diameter						
	F (264-mm dia.)	G (160-mm dia.)	H (116-mm dia.)	I (264-mm dia.)	J (150-mm dia.)	K (107-mm dia.)	L (224 mm × 224 mm)
1.30	-	SGM7D-01G	-	-	-	-	-
2.06	-	-	-	-	-	SGM7D-02K	-
3.00	-	-	SGM7D-03H	-	-	-	-
5.00	-	SGM7D-05G	-	-	-	-	-
6.00	-	-	-	-	SGM7D-06J	SGM7D-06K	SGM7D-06L
8.00	-	SGM7D-08G	-	-	-	SGM7D-08K	-
9.00	-	-	-	-	SGM7D-09J	-	-
12.0	-	-	-	-	-	-	SGM7D-12L
18.0	-	SGM7D-18G	-	-	SGM7D-18J	-	-
20.0	-	-	-	-	SGM7D-20J	-	-
24.0	-	SGM7D-24G	-	-	-	-	-
28.0	-	-	-	SGM7D-28I	-	-	-
30.0	SGM7D-30F	-	-	-	-	-	SGM7D-30L
34.0	-	SGM7D-34G	-	-	-	-	-
38.0	-	-	-	-	SGM7D-38J	-	-
45.0	-	SGM7D-45G	-	-	-	-	-
58.0	SGM7D-58F	-	-	-	-	-	-
70.0	-	-	-	SGM7D-70I	-	-	-
90.0	SGM7D-90F	-	-	-	-	-	-
100	-	-	-	SGM7D-1ZI	-	-	-
110	SGM7D-1AF	-	-	-	-	-	-
130	-	-	-	SGM7D-1CI	-	-	-
220	-	-	-	SGM7D-2BI	-	-	-
240	-	-	-	SGM7D-2DI	-	-	-

Note: The above table shows combinations of the rated torque and outer diameter. The fourth through seventh digits have been omitted.

Specifications and Ratings

Specifications

◆ SGM7D-□□F, -□□G, and -□□H

Voltage		200 V											
Model SGM7D-		30F	58F	90F	1AF	01G	05G	08G	18G	24G	34G	45G	03H
Time Rating		Continuous											
Thermal Class		F											
Insulation Resistance		500 VDC, 10 MΩ min.											
Withstand Voltage		1,500 VAC for 1 minute											
Excitation		Three-phase											
Mounting		Flange-mounted											
Drive Method		Direct drive											
Rotation Direction		Counterclockwise (CCW) for forward reference when viewed from the load side											
Absolute Accuracy		±15 s											
Repeatability		±1.3 s											
Protective Structure *1		Totally enclosed, self-cooled, IP20			Totally enclosed, self-cooled, IP30			Totally enclosed, self-cooled, IP20			Totally enclosed, self-cooled, IP30		
Environmental Conditions	Surrounding Air Temperature		0°C to 40°C (with no freezing)										
	Surrounding Air Humidity		20% to 80% relative humidity (with no condensation)										
	Installation Site		<ul style="list-style-type: none"> • Must be indoors and free of corrosive and explosive gases. • Must be well-ventilated and free of dust and moisture. • Must facilitate inspection and cleaning. • Must have an altitude of 1,000 m or less. • Must be free of strong magnetic fields. 										
	Storage Environment		Store the Servomotor in the following environment if you store it with the power cable disconnected. Storage Temperature: -20°C to 60°C (with no freezing) Storage Humidity: 20% to 80% relative humidity (with no condensation)										
Mechanical Tolerances *2	Runout of Output Shaft	Standard Mechanical Precision	mm	0.1	–	0.1	0.1	–					
	Surface/Runout at End of Output Shaft	High Mechanical Precision	mm	0.005	0.01	0.005	0.01						
Applicable SERVOPACKs		SGD7S-	120A *3		2R8A *3, 2R8F *3		120A *3			2R8A *3, 2R8F *3			
		SGD7W-SGD7C-	–										

*1. The hollow hole section, motor mounting surface, and gap around the rotating part on non-load side are excluded. Protective structure specifications apply only when the special cable is used.

*2. Refer to the following figure for the relevant locations on the Servomotor. Refer to the dimensional drawings of the individual Servomotors for more information on tolerances.

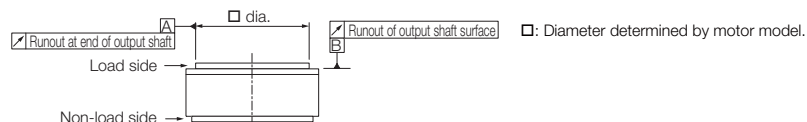

*3. An SGM7D Servomotor is used together with an FT-specification SERVOPACK. The following SERVOPACK models can be used.

- SGD7S-□□□□□□A□□□F82□
- SGD7S-□□□□00A□□□F83□

◆ SGM7D-□□I and -□□J

Voltage		200 V										
Model SGM7D-		28I	70I	1ZI	1CI	2BI	2DI	06J	09J	18J	20J	38J
Time Rating		Continuous										
Thermal Class		F										
Insulation Resistance		500 VDC, 10 MΩ min.										
Withstand Voltage		1,500 VAC for 1 minute										
Excitation		Three-phase										
Mounting		Flange-mounted										
Drive Method		Direct drive										
Rotation Direction		Counterclockwise (CCW) for forward reference when viewed from the load side										
Absolute Accuracy		±15 s										
Repeatability		±1.3 s										
Protective Structure*1		Totally enclosed, self-cooled, IP30										
Environmental Conditions	Surrounding Air Temperature		0°C to 40°C (with no freezing)									
	Surrounding Air Humidity		20% to 80% relative humidity (with no condensation)									
	Installation Site		<ul style="list-style-type: none"> • Must be indoors and free of corrosive and explosive gases. • Must be well-ventilated and free of dust and moisture. • Must facilitate inspection and cleaning. • Must have an altitude of 1,000 m or less. • Must be free of strong magnetic fields. 									
	Storage Environment		Store the Servomotor in the following environment if you store it with the power cable disconnected. Storage Temperature: -20°C to 60°C (with no freezing) Storage Humidity: 20% to 80% relative humidity (with no condensation)									
Mechanical Tolerances*2	Runout of Output Shaft Surface/ Runout at End of Output Shaft	Standard Mechanical Precision	mm	0.1								
		High Mechanical Precision	mm	0.005	0.02			0.005		0.01		
Applicable SERVOPACKs		SGD7S-	120A*3									
		SGD7W- SGD7C-	-									

*1. The hollow hole section, motor mounting surface, and gap around the rotating part on non-load side are excluded. Protective structure specifications apply only when the special cable is used.

*2. Refer to the following figure for the relevant locations on the Servomotor. Refer to the dimensional drawings of the individual Servomotors for more information on tolerances.

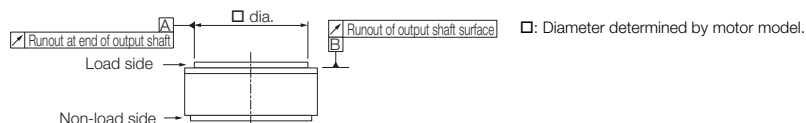

*3. An SGM7D Servomotor is used together with an FT-specification SERVOPACK. The following SERVOPACK models can be used.

- SGD7S-□□□□□□A□□□F82□
- SGD7S-□□□□00A□□□F83□

◆ SGM7D-□□K and -□□L

Voltage		200 V					
Model SGM7D-		02K	06K	08K	06L	12L	30L
Time Rating		Continuous					
Thermal Class		F					
Insulation Resistance		500 VDC, 10 MΩ min.					
Withstand Voltage		1,500 VAC for 1 minute					
Excitation		Three-phase					
Mounting		Flange-mounted					
Drive Method		Direct drive					
Rotation Direction		Counterclockwise (CCW) for forward reference when viewed from the load side					
Absolute Accuracy		±15 s					
Repeatability		±1.3 s					
Protective Structure*1		Totally enclosed, self-cooled, IP30					
Environmental Conditions	Surrounding Air Temperature		0°C to 40°C (with no freezing)				
	Surrounding Air Humidity		20% to 80% relative humidity (with no condensation)				
	Installation Site		<ul style="list-style-type: none"> • Must be indoors and free of corrosive and explosive gases. • Must be well-ventilated and free of dust and moisture. • Must facilitate inspection and cleaning. • Must have an altitude of 1,000 m or less. • Must be free of strong magnetic fields. 				
	Storage Environment		Store the Servomotor in the following environment if you store it with the power cable disconnected. Storage Temperature: -20°C to 60°C (with no freezing) Storage Humidity: 20% to 80% relative humidity (with no condensation)				
Mechanical Tolerances*2	Runout of Output Shaft Surface/	Standard Mechanical Precision	mm	0.1		0.05	
	Runout at End of Output Shaft	High Mechanical Precision	mm	0.01		0.005	
Applicable SERVOPACKs		SGD7S-		2R8A*3, 2R8F*3		120A*3	
		SGD7W-SGD7C-		-			

*1. The hollow hole section, motor mounting surface, and gap around the rotating part on non-load side are excluded. Protective structure specifications apply only when the special cable is used.

*2. Refer to the following figure for the relevant locations on the Servomotor. Refer to the dimensional drawings of the individual Servomotors for more information on tolerances.

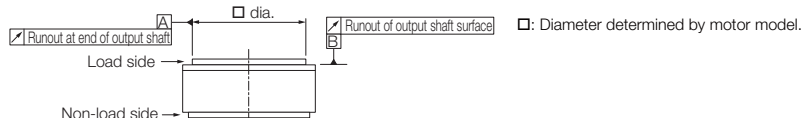

*3. An SGM7D Servomotor is used together with an FT-specification SERVOPACK. The following SERVOPACK models can be used.

- SGD7S-□□□□□□A□□□F82□
- SGD7S-□□□□00A□□□F83□

Ratings

◆ SGM7D-□□F, -□□G, and -□□H

Voltage		200 V												
Model SGM7D-		30F	58F	90F	1AF	01G	05G	08G	18G	24G	34G	45G	03H	
Rated Output	W	188	364	565	691	16	63	101	226	302	320	565	38	
Rated Torque* ¹	N·m	30.0	58.0	90.0	110	1.30	5.00	8.00	18.0	24.0	34.0	45.0	3.00	
Rated Intermittent Torque* ²	N·m	—	—	—	—	—	—	—	—	27.0	40.0	52.0	—	
Instantaneous Maximum Torque	N·m	50.0	100	150	200	4.00	6.00	15.0	30.0	45.0	60.0	75.0	4.00	
Stall Torque	N·m	30.0	58.0	90.0	110	1.30	5.00	8.00	18.0	24.0	34.0	45.0	3.00	
Rated Current	Arms	5.7	6.4	5.9	5.0	1.7	1.6	3.4	3.4	3.1	3.3	4.8	1.1	
Instantaneous Maximum Current	Arms	14.1				4.2	3.5	10.6					3.5	
Rated Motor Speed	min ⁻¹	60				120					90	120	120	
Maximum Motor Speed	min ⁻¹	72				150			144				150	
Torque Constant	N·m/Arms	6.25	12.5	17.8	24.5	1.09	3.84	2.82	5.76	8.57	11.2	10.2	3.01	
Motor Moment of Inertia	×10 ⁻⁴ kg·m ²	960	1190	1420	1670	55.0	75.0	120	150	190	230	270	25.0	
Rated Power Rate	kW/s	9.38	28.3	57.0	72.5	0.307	3.33	5.33	21.6	30.3	50.3	75.0	3.60	
Rated Angular Acceleration Rate	rad/s ²	313	487	634	659	236	667	667	1200	1260	1480	1670	1200	
Heat Sink Size	mm	550 × 550 × 30 (aluminum)											350 × 350 × 20 (steel)	
Allowable Load Moment of Inertia (Motor Moment of Inertia Ratio)	times	200 500* ⁴	150 400* ⁴	150 350* ⁴	130 300* ⁴	130	300	400 1000* ⁴	350 900* ⁴	300 750* ⁴	250 650* ⁴	200 450* ⁴	600	
	With External Regenerative Resistor and External Dynamic Brake Resistor* ³	times	2500	3500	4000	5000	130	300	2000	3000	4000	4000	4000	600
Allowable Loads* ⁵	Allowable Thrust Load	Forward	N				4 × 10 ⁴		50	200	3 × 10 ⁴			50
		Reverse	N				2 × 10 ⁴		50	200	1 × 10 ⁴			50
	Allowable Moment Load	N·m	400				—	50	200			—	—	
Rigidities	Thrust Displacement Rigidity	Forward	mm/N				2 × 10 ⁻⁶		—	2.5 × 10 ⁻⁶			—	
		Reverse	mm/N				3 × 10 ⁻⁶		—	3 × 10 ⁻⁶			—	
	Moment Displacement Rigidity	rad/N·m	4 × 10 ⁻⁷				—	—	1 × 10 ⁻⁶			—		

*1. The rated torques are the continuous allowable torque values at a surrounding air temperature of 40°C with an aluminum or steel heat sink of the dimensions given in the table.

*2. The rated intermittent torque is the value for 60% ED.

*3. To externally connect dynamic brake resistance, select hardware option specification 020 for the SERVOPACK. However, you cannot externally connect dynamic brake resistance if you use the following SERVOPACKS (maximum applicable motor capacity: 400 W).

- SGD7S-2R8□□□A020F82□
- SGD7S-2R8□00A020F83□

*4. If you use an SGD7S-120A008 SERVOPACK and SGM7D Servomotor together, use the ratios given on the bottom line.

*5. The thrust loads and moment loads that are applied while a Servomotor is operating are roughly classified into the following patterns. Design the machine so that the thrust loads or moment loads will not exceed the values given in the table. The allowable load is for a static load in one direction.

When designing the system, multiply the allowable load by the following safety coefficient depending on the type of load.

- Smooth load with no shock: 1/3
- Light repetitive load: 1/5
- Shock load: 1/10

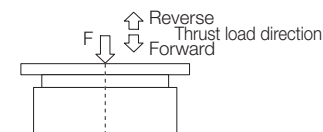

Where F is the external force,
Thrust load = F + Load mass
Moment load = 0

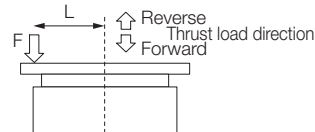

Where F is the external force,
Thrust load = F + Load mass
Moment load = F × L

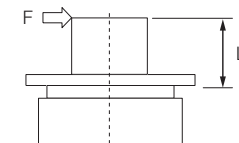

Where F is the external force,
Thrust load = Load mass
Moment load = F × L

Note: 1. These values are for operation in combination with a SERVOPACK when the temperature of the armature winding is 20°C. These are typical values.

2. For the bearings used in these Servomotors, the loss depends on the bearing temperature. The amount of heat loss is higher at low temperatures.

◆ SGM7D-□□I and -□□J

Voltage		200 V												
Model SGM7D-		28I	70I	1ZI	1CI	2BI	2DI	06J	09J	18J	20J	38J		
Rated Output	W	264	440	628	817	691	754	75	113	226	251	358		
Rated Torque* ¹	N·m	28.0	70.0	100	130	220	240	6.00	9.00	18.0	20.0	38.0		
Instantaneous Maximum Torque	N·m	50.0	100	150	200	300	400	8.00	15.0	30.0	45.0	60.0		
Stall Torque	N·m	28.0	70.0	100	130	220	240	6.00	9.00	18.0	20.0	38.0		
Rated Current	Arms	5.2	5.6	5.5	5.0	5.6	4.8	4.0	3.4	3.0	2.2	3.1		
Instantaneous Maximum Current	Arms	14.1					10.6							
Rated Motor Speed	min ⁻¹	90	60			30		120				90		
Maximum Motor Speed	min ⁻¹	108	72			60	48	144						
Torque Constant	N·m/Arms	6.90	13.9	20.8	27.8	41.5	54.4	1.71	3.29	6.62	9.88	13.3		
Motor Moment of Inertia	×10 ⁻⁴ kg·m ²	1800	2000	2300	2850	3400	4000	150	210	240	260	330		
Rated Power Rate	kW/s	4.36	24.5	43.5	59.3	142	144	2.40	3.86	13.5	15.4	43.8		
Rated Angular Acceleration Rate	rad/s ²	156	350	435	456	647	600	400	429	750	769	1150		
Heat Sink Size	mm	550 × 550 × 30												
Allowable Load Moment of Inertia (Motor Moment of Inertia Ratio)	times	50	100	90	80	100	150	350	250	240	220	180		
		125* ²	250* ²	230* ²	200* ²			700* ²	600* ²	550* ²	550* ²	450* ²		
Allowable Thrust Loads* ³	With External Regenerative Resistor and External Dynamic Brake Resistor* ³	times	800	2000	2500	3000	100	150	700	900	2500	2000		
Allowable Moment Loads* ³	Allowable Thrust Load	Forward	N					4 × 10 ⁴					3 × 10 ⁴	
		Reverse	N					2 × 10 ⁴					1 × 10 ⁴	
	Allowable Moment Load	N·m						400					200	
Rigidities	Thrust Displacement Rigidity	Forward	mm/N					2 × 10 ⁻⁶					3 × 10 ⁻⁶	
		Reverse	mm/N					3 × 10 ⁻⁶					4 × 10 ⁻⁶	
	Moment Displacement Rigidity	rad/N·m						4 × 10 ⁻⁷					2 × 10 ⁻⁶	

*1. The rated torques are the continuous allowable torque values at a surrounding air temperature of 40°C with an aluminum heat sink of the dimensions given in the table.

*2. If you use an SGD7S-120A008 SERVOPACK and SGM7D Servomotor together, use the ratios given on the bottom line.

*3. The thrust loads and moment loads that are applied while a Servomotor is operating are roughly classified into the following patterns. Design the machine so that the thrust loads or moment loads will not exceed the values given in the table.

The allowable load is for a static load in one direction.

When designing the system, multiply the allowable load by the following safety coefficient depending on the type of load.

- Smooth load with no shock: 1/3
- Light repetitive load: 1/5
- Shock load: 1/10

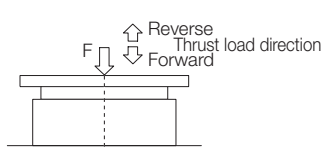

Where F is the external force,
Thrust load = F + Load mass
Moment load = 0

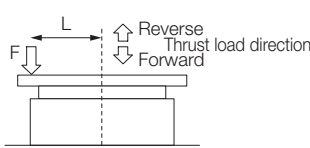

Where F is the external force,
Thrust load = F + Load mass
Moment load = F × L

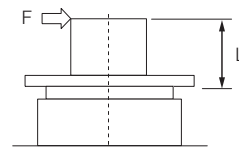

Where F is the external force,
Thrust load = Load mass
Moment load = F × L

Note: 1. These values are for operation in combination with a SERVOPACK when the temperature of the armature winding is 20°C. These are typical values.

2. For the bearings used in these Servomotors, the loss depends on the bearing temperature. The amount of heat loss is higher at low temperatures.

◆ SGM7D-□□K and -□□L

Voltage		200 V					
Model SGM7D-		02K	06K	08K	06L	12L	30L
Rated Output	W	52	151	201	113	226	565
Rated Torque*1	N·m	2.06	6.00	8.00	6.00	12.0	30.0
Repetitive Rated Torque*2	N·m	—	6.90	—	—	—	—
Instantaneous Maximum Torque	N·m	5.00	10.0	15.0	10.0	20.0	40.0
Stall Torque	N·m	2.06	6.00	8.00	6.00	12.0	30.0
Rated Current	Arms	1.6	1.8	1.6	1.7	2.1	8.1
Instantaneous Maximum Current	Arms	4.2			4.2	4.2	14.1
Rated Motor Speed	min ⁻¹	240			180		
Maximum Motor Speed	min ⁻¹	360			216		
Torque Constant	N·m/Arms	1.83	3.67	5.50	4.13	6.59	3.95
Motor Moment of Inertia	×10 ⁻⁴ kg·m ²	60.0	70.0	80.0	220	220	370
Rated Power Rate	kW/s	0.707	5.14	8.00	1.64	6.55	24.3
Rated Angular Acceleration Rate	rad/s ²	343	857	1000	273	545	811
Heat Sink Size	mm	550 × 550 × 30			650 × 650 × 30		
Allowable Load Moment of Inertia (Motor Moment of Inertia Ratio)	times	200	350	25	450	20	60 130*4
	With External Regenerative Resistor and External Dynamic Brake Resistor*3	times	200	350	25	450	20
Allowable Loads*5	Allowable Thrust Load	Forward	N	5 × 10 ³			2000
		Reverse	N	3 × 10 ³			1000
	Allowable Moment Load	N·m	20			100	
Rigidities	Thrust Displace- ment Rigidity	Forward	mm/N	4 × 10 ⁻⁶			—
		Reverse	mm/N	8 × 10 ⁻⁶			—
	Moment Displacement Rigidity	rad/N·m	8 × 10 ⁻⁶			—	

*1. The rated torques are the continuous allowable torque values at a surrounding air temperature of 40°C with an aluminum heat sink of the dimensions given in the table.

*2. The rated intermittent torque is the value for 60% ED.

*3. To externally connect dynamic brake resistance, select hardware option specification 020 for the SERVOPACK. However, you cannot externally connect dynamic brake resistance if you use the following SERVOPACKS (maximum applicable motor capacity: 400 W).

- SGD7S-2R8□□□A020F82□
- SGD7S-2R8□00A020F83□

*4. If you use an SGD7S-120A008 SERVOPACK and SGM7D Servomotor together, use the ratios given on the bottom line.

*5. The thrust loads and moment loads that are applied while a Servomotor is operating are roughly classified into the following patterns. Design the machine so that the thrust loads or moment loads will not exceed the values given in the table.

The allowable load is for a static load in one direction.

When designing the system, multiply the allowable load by the following safety coefficient depending on the type of load.

- Smooth load with no shock: 1/3
- Light repetitive load: 1/5
- Shock load: 1/10

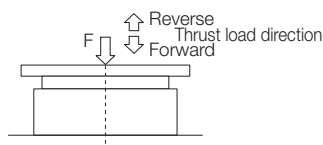

Where F is the external force,
Thrust load = F + Load mass
Moment load = 0

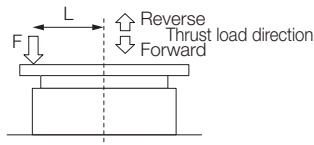

Where F is the external force,
Thrust load = F + Load mass
Moment load = F × L

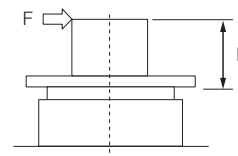

Where F is the external force,
Thrust load = Load mass
Moment load = F × L

Note: 1. These values are for operation in combination with a SERVOPACK when the temperature of the armature winding is 20°C. These are typical values.

2. For the bearings used in these Servomotors, the loss depends on the bearing temperature. The amount of heat loss is higher at low temperatures.

Torque-Motor Speed Characteristics

- A** : Continuous duty zone (dotted lines): With 60%ED 10 min. duty factor
B : Intermittent duty zone* (solid lines): With three-phase 200-V, single-phase 230-V, and single-phase 200-V input

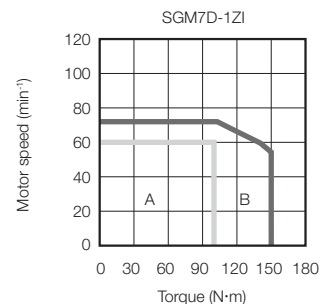
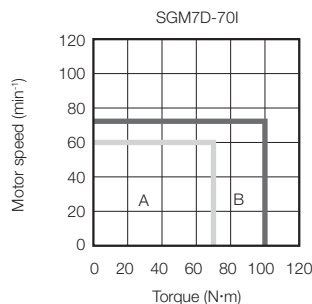
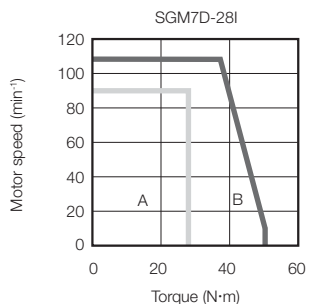
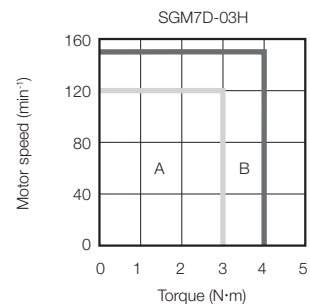
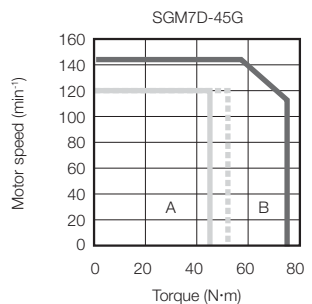
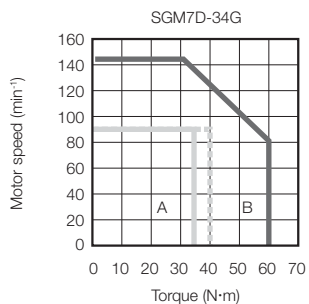
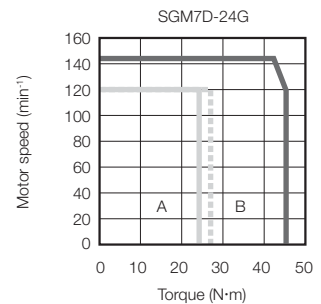
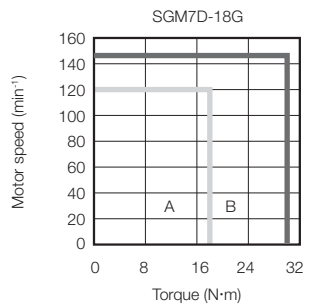
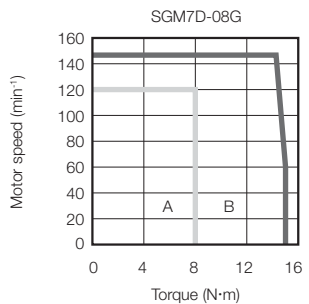
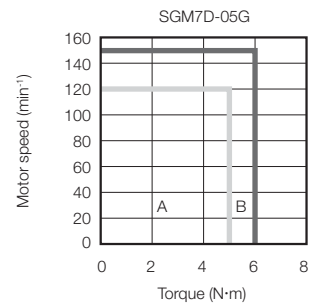
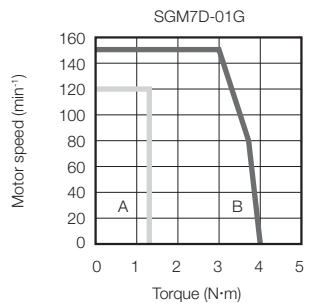
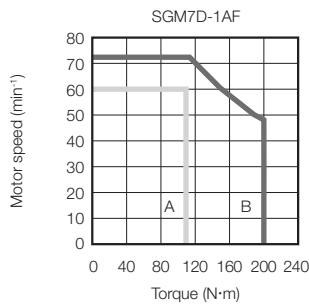
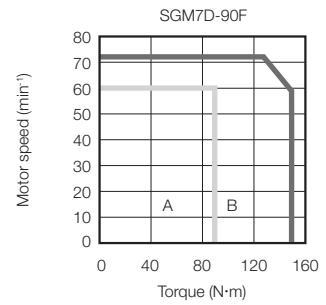
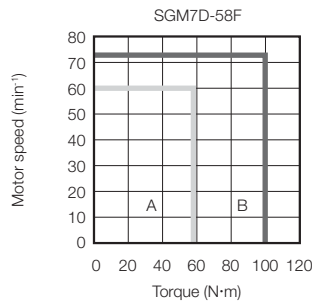
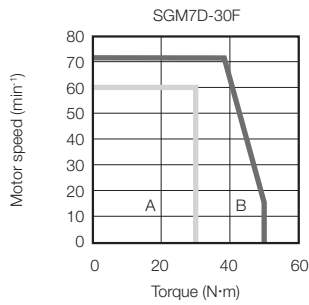

Direct Drive Servomotors
SGM7D (With Core, Outer Rotor)

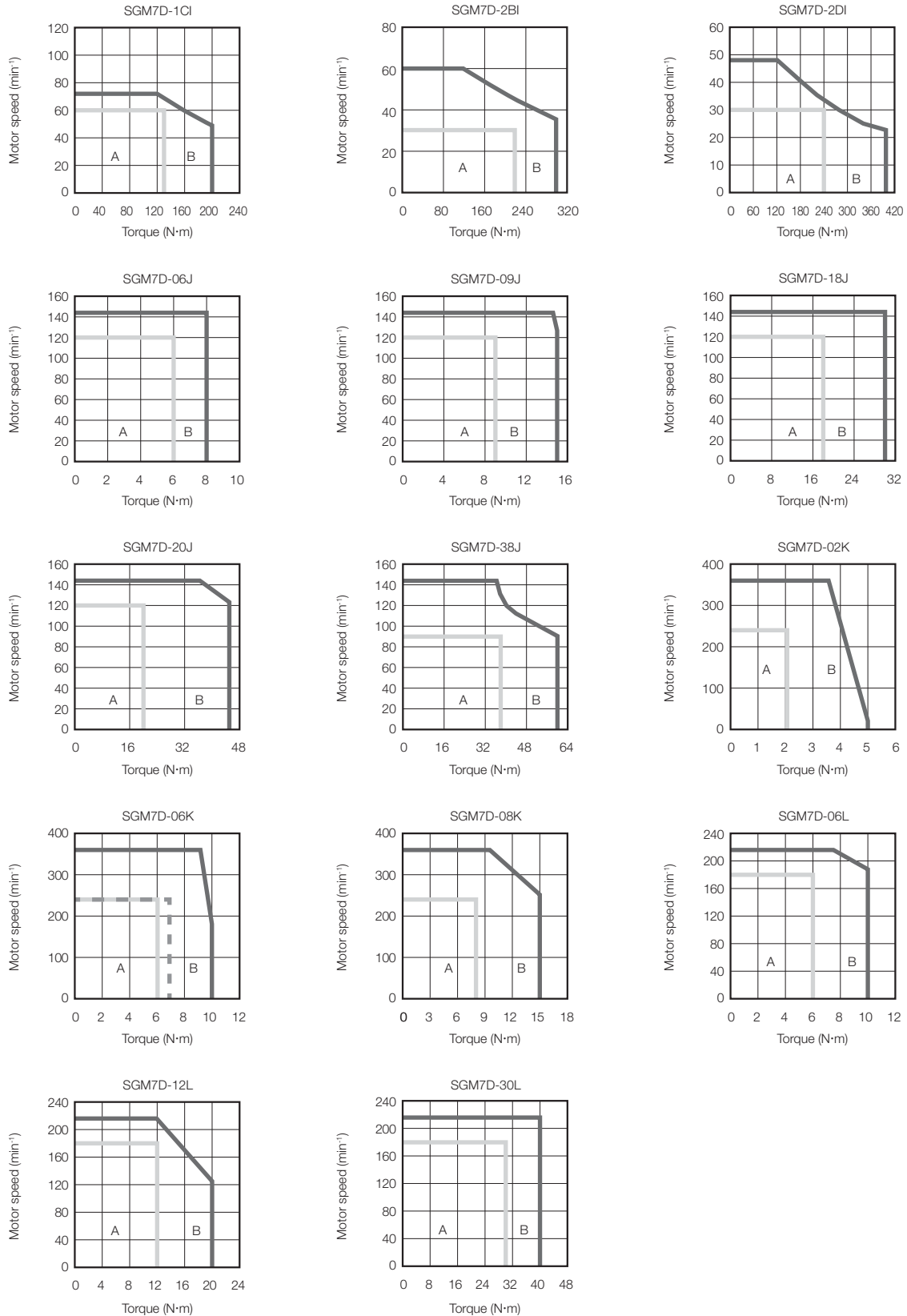

* The characteristics are the same for three-phase 200 V and single-phase 200 V input.

Contact your Yaskawa representative for information on the characteristics for single-phase 100 V input.

Note: 1. These values (typical values) are for operation in combination with a SERVOPACK when the temperature of the armature winding is 20°C.

2. The characteristics in the intermittent duty zone depend on the power supply voltage.

3. If the effective torque is within the allowable range for the rated torque, the Servomotor can be used within the intermittent duty zone.

4. If you use a Servomotor Main Circuit Cable that exceeds 20 m, the intermittent duty zone in the torque-motor speed characteristics will become smaller because the voltage drop increases.

Servomotor Overload Protection Characteristics

The overload detection level is set for hot start conditions with a Servomotor surrounding air temperature of 40°C.

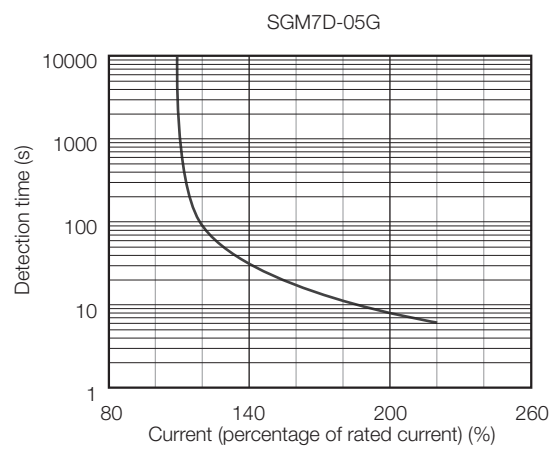
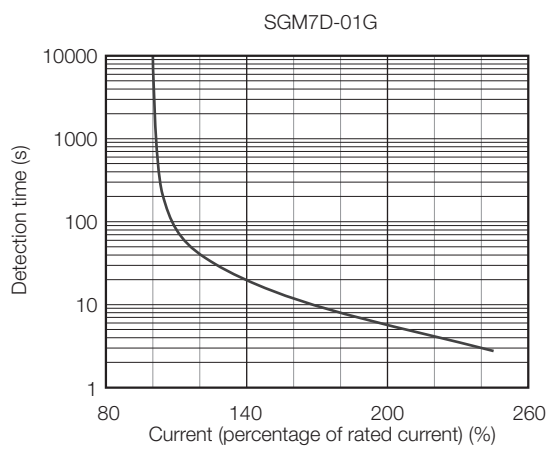
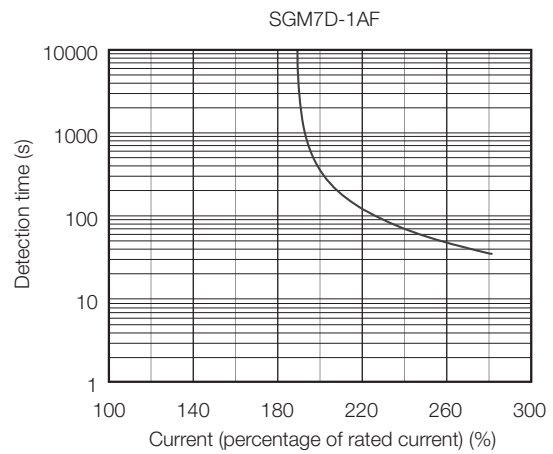
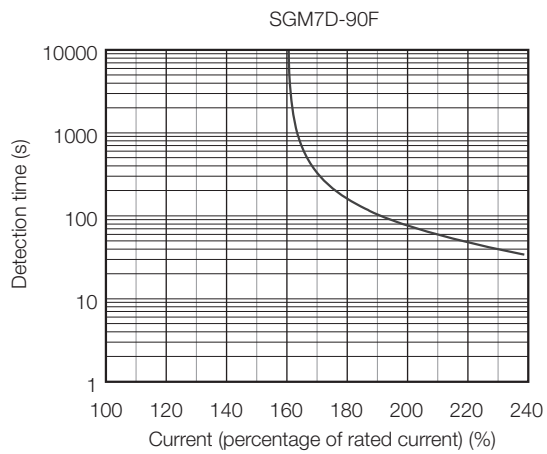
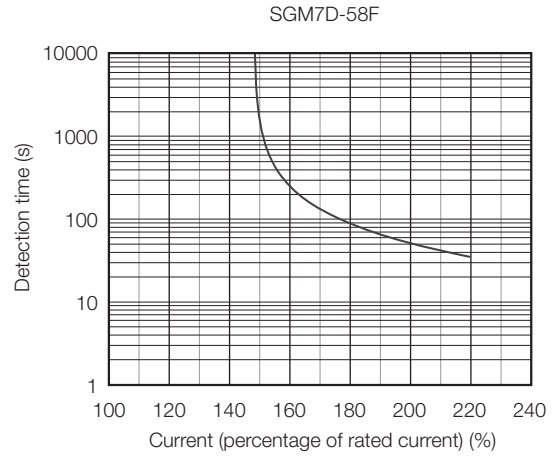
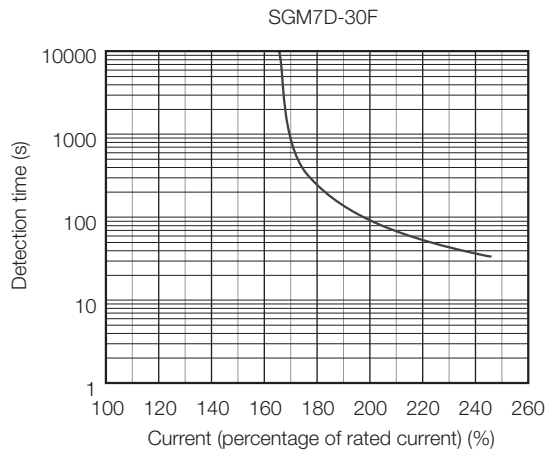

Direct Drive Servomotors
SGM7D (With Core, Outer Rotor)

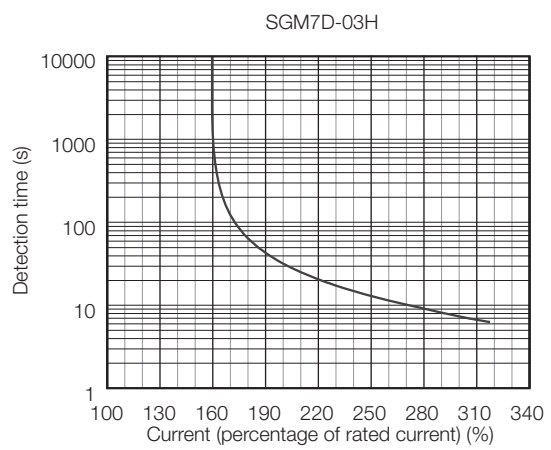
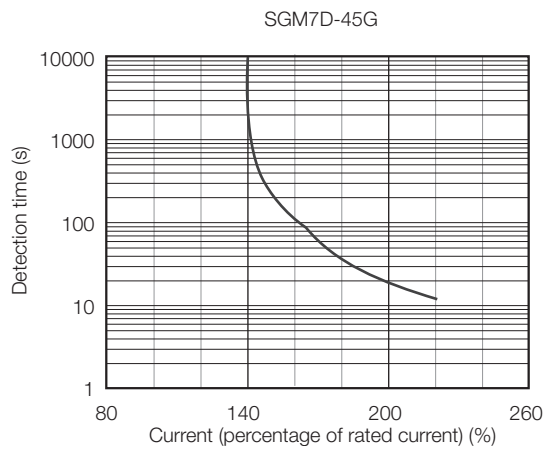
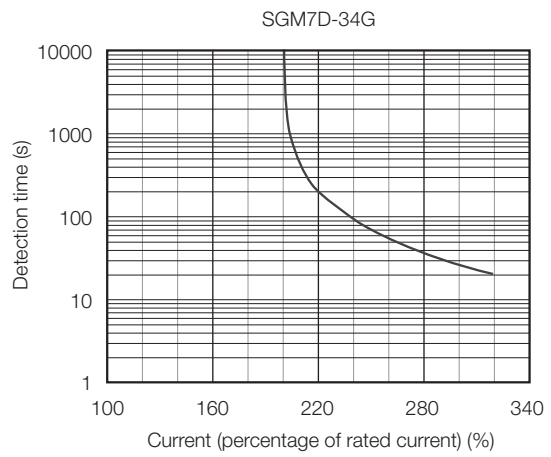
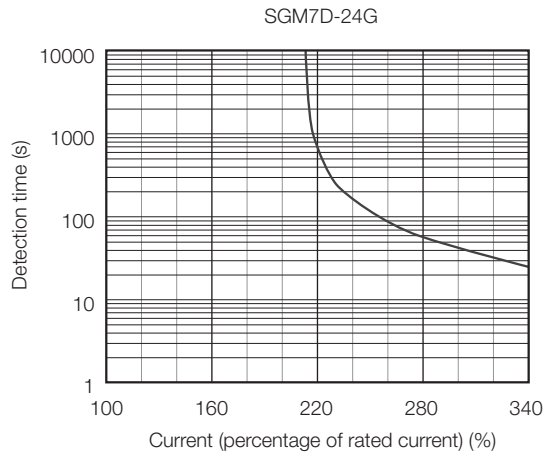
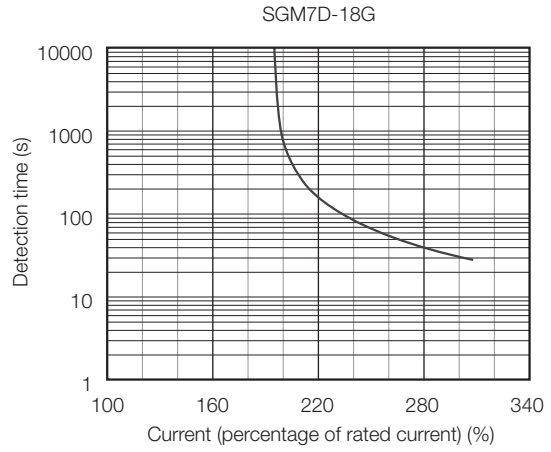
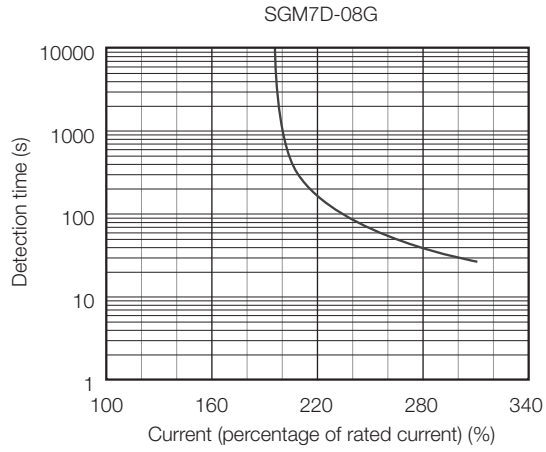

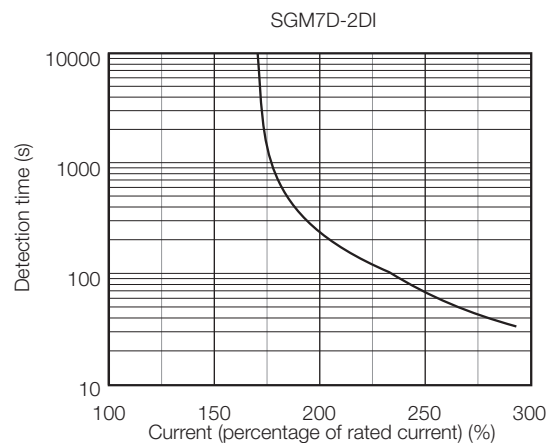
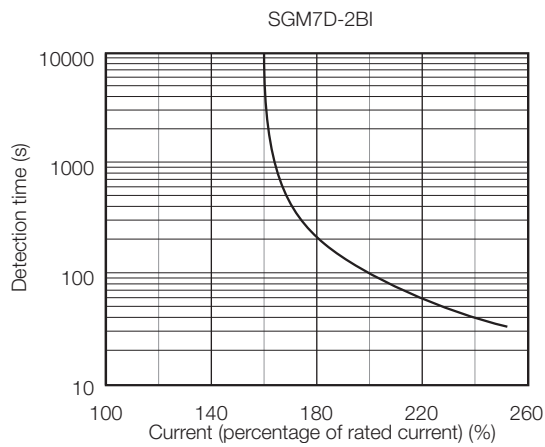
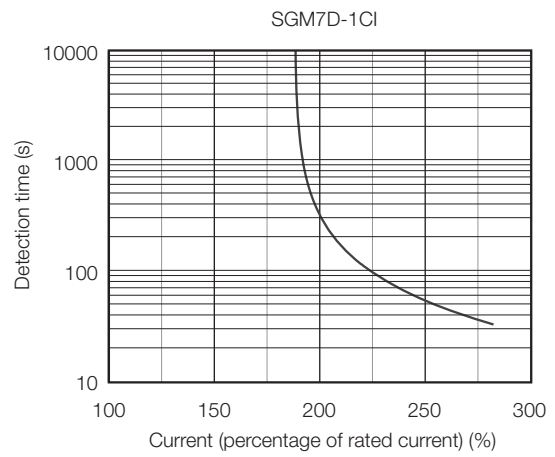
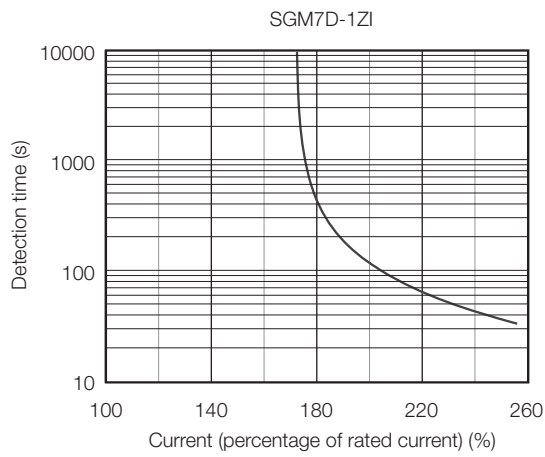
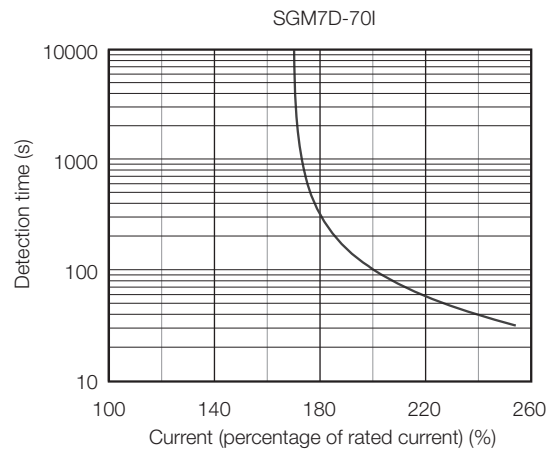
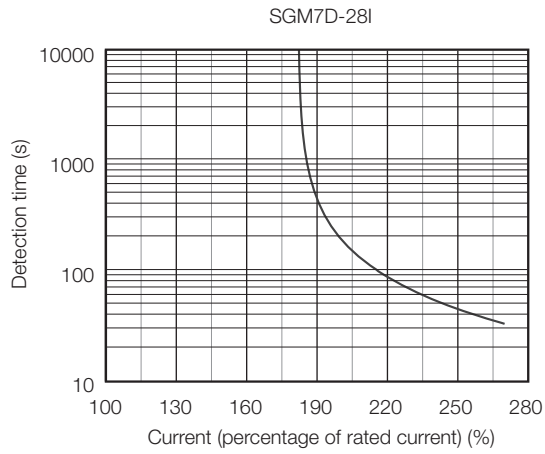

Direct Drive Servomotors
SGM7D (With Core, Outer Rotor)

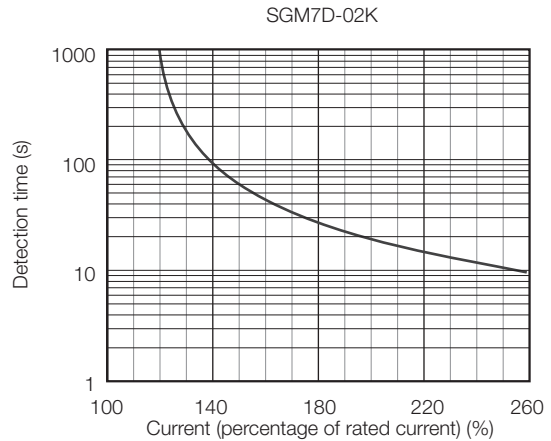
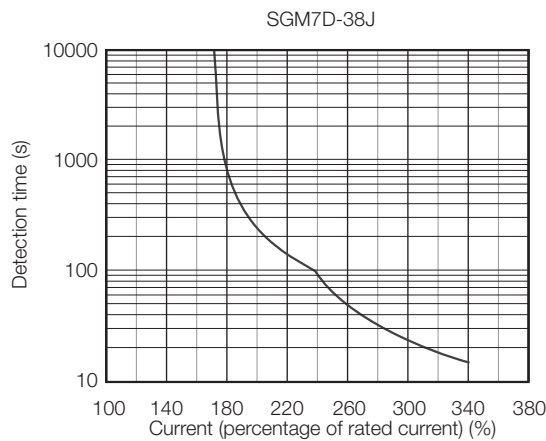
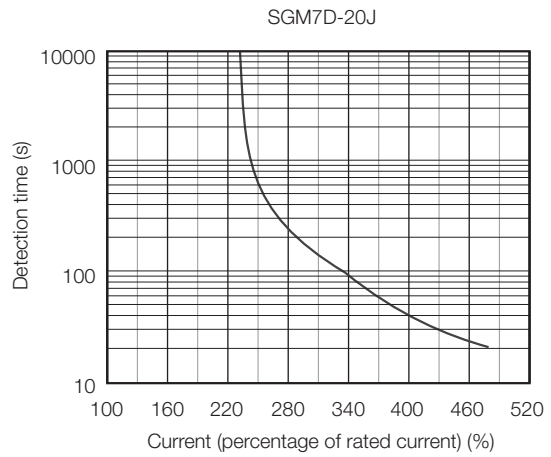
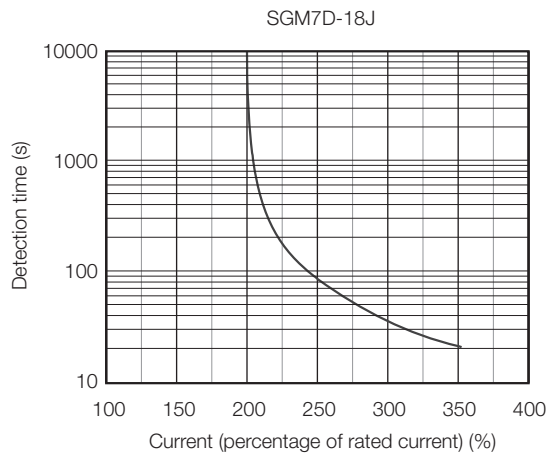
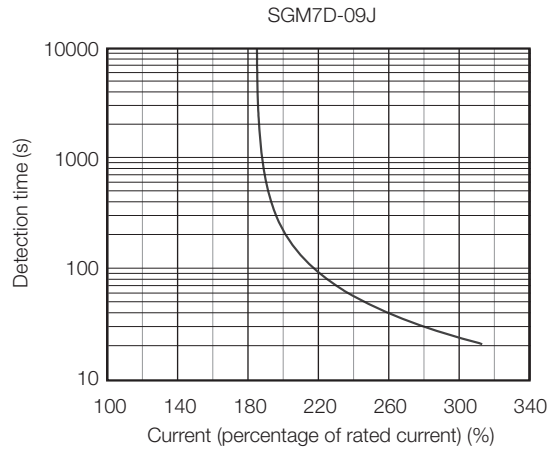
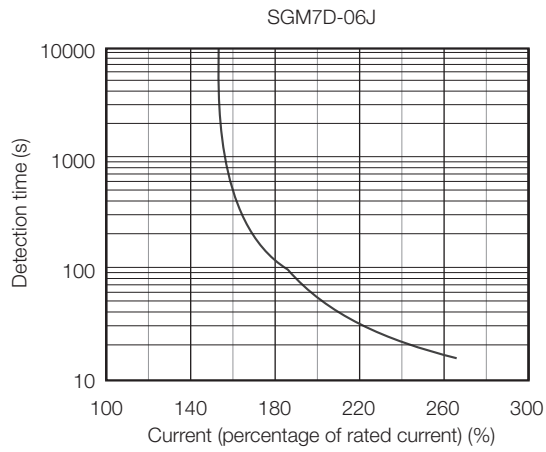

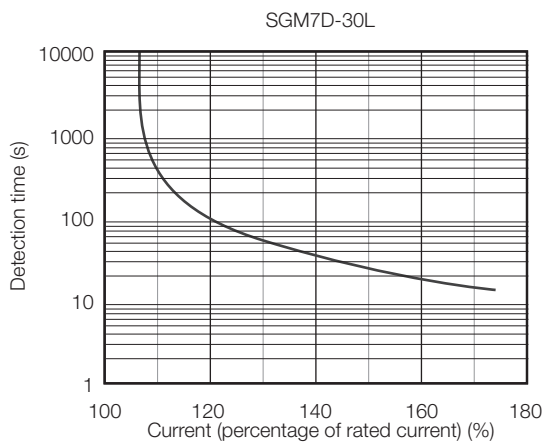
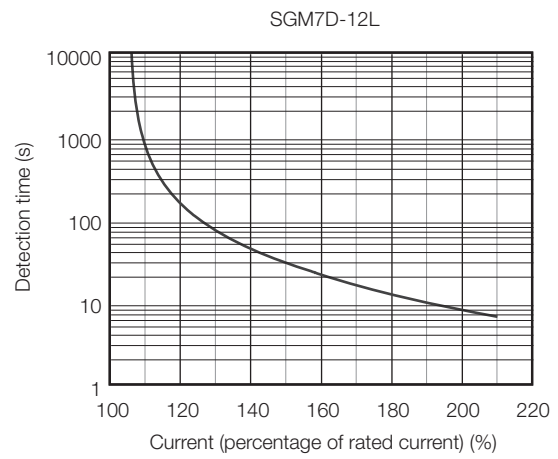
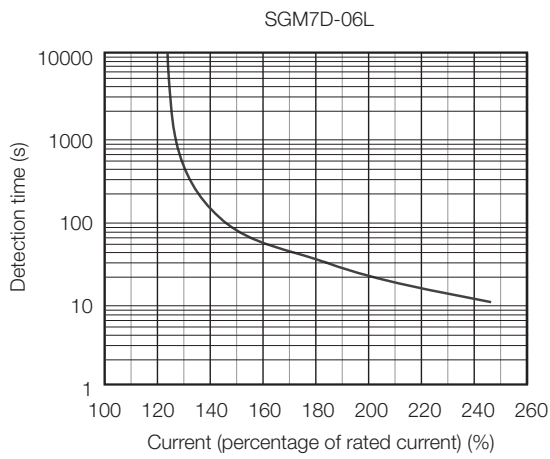
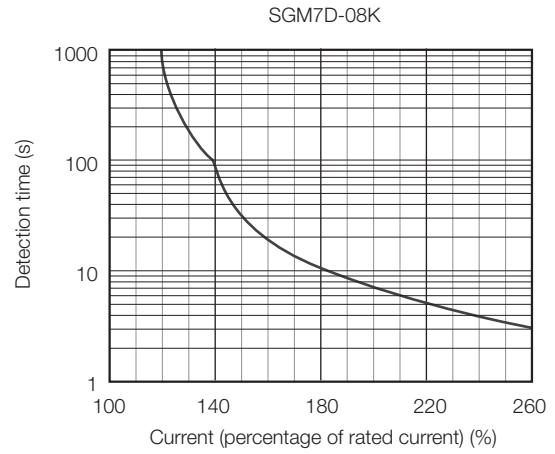
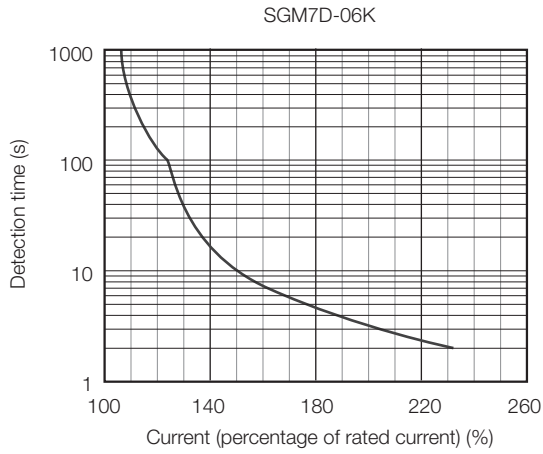

Note: The above overload protection characteristics do not mean that you can perform continuous duty operation with an output of 100% or higher.

Use the Servomotor so that the effective force remains within the continuous duty zone. Refer to the following section for details on the effective torque.

 **Torque-Motor Speed Characteristics** (page 125)

Allowable Load Moment of Inertia

The allowable load moments of inertia (motor moment of inertia ratios) for the Servomotors are given in the *Ratings* (pages 122 to 124). The values are determined by the regenerative energy processing capacity of the SERVOPACK and are also affected by the drive conditions of the Servomotor. Perform the required Steps for each of the following cases.

Use the SigmaSize+ AC Servo Drive Capacity Selection Program to check the driving conditions. Contact your Yaskawa representative for information on this program.

◆ Exceeding the Allowable Load Moment of Inertia

Use one of the following measures to adjust the load moment of inertia to within the allowable value.

- Reduce the torque limit.
- Reduce the deceleration rate.
- Reduce the maximum motor speed.

If the above steps is not possible, install an external regenerative resistor.

Information An Overvoltage Alarm (A.400) is likely to occur during deceleration if the load moment of inertia exceeds the allowable load moment of inertia. SERVOPACKs with a built-in regenerative resistor may generate a Regenerative Overload Alarm (A.320). Refer to *Built-In Regenerative Resistor* (page 472) for the regenerative power (W) that can be processed by the SERVOPACKs.

Install an External Regenerative Resistor when the built-in regenerative resistor cannot process all of the regenerative power.

◆ When an External Regenerative Resistor Is Required

Install the External Regenerative Resistor. Refer to the following section for the recommended products.

 *External Regenerative Resistors* (page 472)

External Dimensions

◆ SGM7D-□□□

- Servomotors with the Cable on the Side

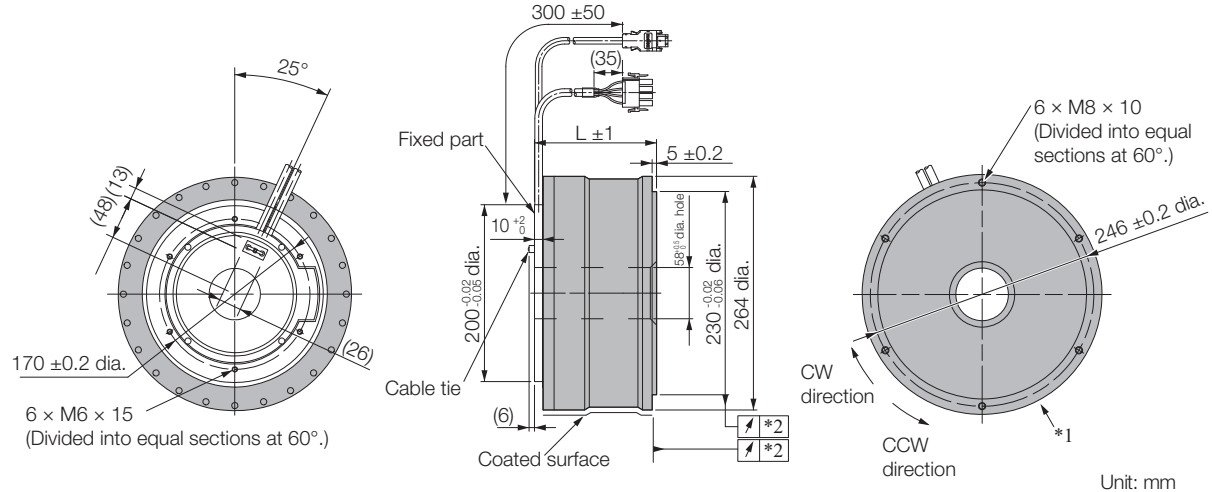

- Servomotors with the Cable on the Bottom

6 × M6 × 15
(Divided into equal sections at 60°.)

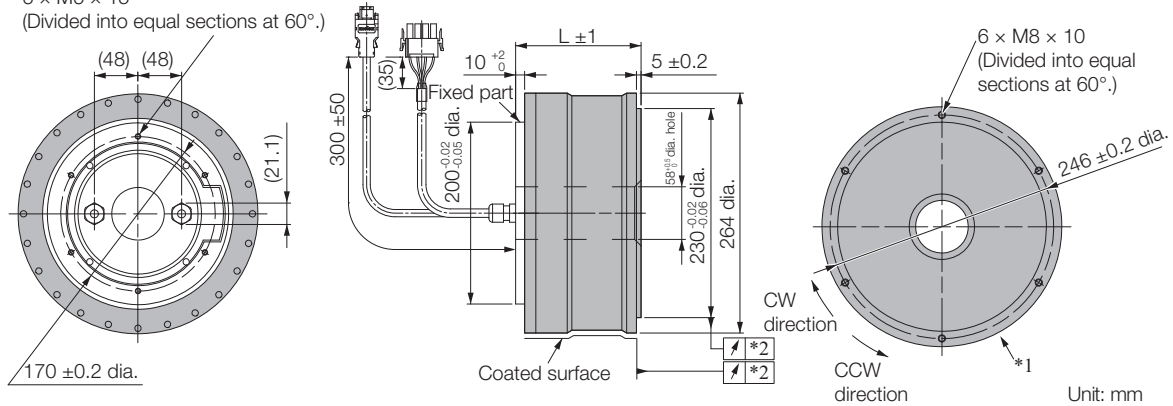

*1. The shaded section indicates the rotating parts.

*2. The precision depends on the option specification. Refer to the following section for details.

Specifications (page 119)

Note: Values in parentheses are reference dimensions.

Model SGM7D-	L	Approx. Mass [kg]
30F□C□□	113 ± 1	14.5
58F□C□□	138 ± 1	19
90F□C□□	163 ± 1	24
1AF□C□□	188 ± 1	29

■ Connector Specifications

- Servomotor Connector

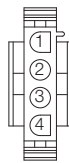

1	Phase U	Red
2	Phase V	Gray
3	Phase W	Blue
4	FG (frame ground)	Green (yellow)

Models

- Plug: 350779-1
 - Pins: 350218-3 or 350547-3 (No.1 to 3)
 - Ground pin: 350654-1 or 350669-1 (No. 4)
- Manufacturer: Tyco Electronics Japan G.K.

Mating Connector

- Cap: 350780-1
- Socket: 350536-3 or 350550-3

- Encoder Connector

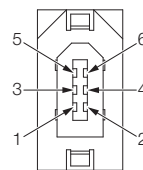

1	PG5V
2	PG0V
3*	BAT
4*	BATO
5	PS
6	/PS
Connector case	FG (frame ground)

* Only absolute-value models with multiturn data.

Model: 55102-0600

Manufacturer: Molex Japan LLC

Mating connector: 54280-0609

◆ SGM7D-01G

• Servomotors with the Cable on the Side

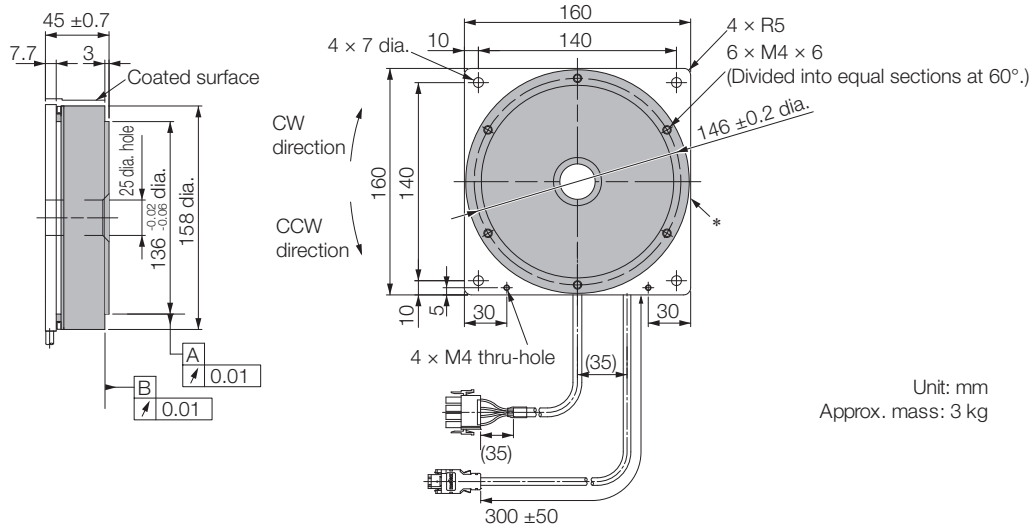

* The shaded section indicates the rotating parts.
Note: Values in parentheses are reference dimensions.

◆ SGM7D-05G

• Servomotors with the Cable on the Side

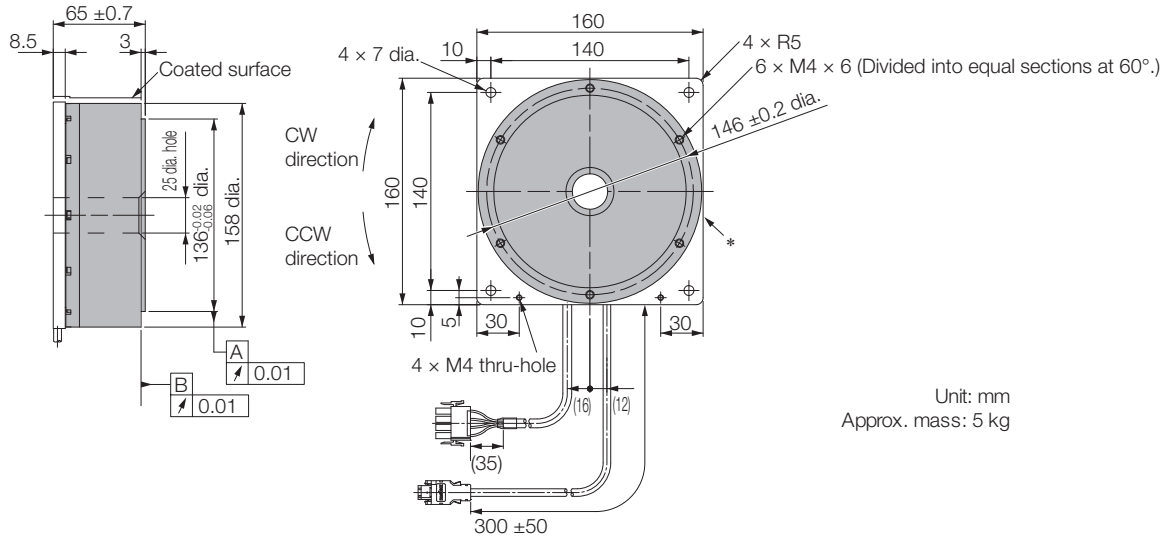

* The shaded section indicates the rotating parts.
Note: Values in parentheses are reference dimensions.

■ Connector Specifications

• Servomotor Connector

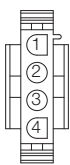

1	Phase U	Red
2	Phase V	Gray
3	Phase W	Blue
4	FG (frame ground)	Green

Models

- Plug: 350779-1
- Pins: 350561-3 or 350690-3 (No. 1 to 3)
- Ground pin: 350654-1 or 350669-1 (No. 4)
- Manufacturer: Tyco Electronics Japan G.K.

Mating Connector

- Cap: 350780-1
- Socket: 350570-3 or 350689-3

• Encoder Connector

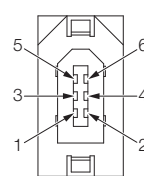

1	PG5V
2	PG0V
3*	BAT
4*	BAT0
5	PS
6	/PS
Connector case	FG (frame ground)

* Only absolute-value models with multiturn data.

Model: 55102-0600

Manufacturer: Molex Japan LLC

Mating connector: 54280-0609

◆ SGM7D-08G, -18G, -24G, -34G, and -45G

• Servomotors with the Cable on the Bottom

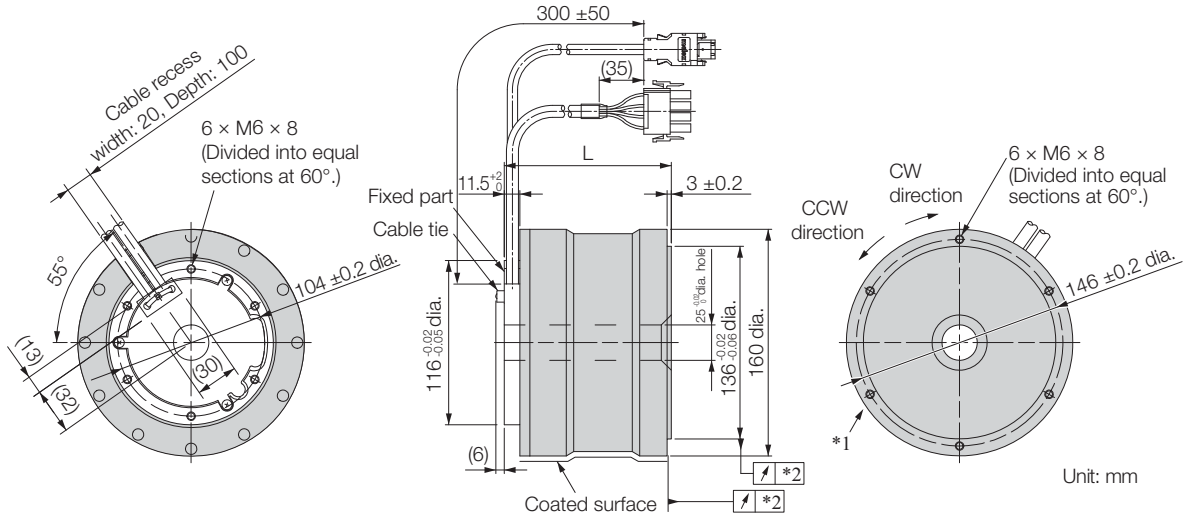

• Servomotors with the Cable on the Bottom

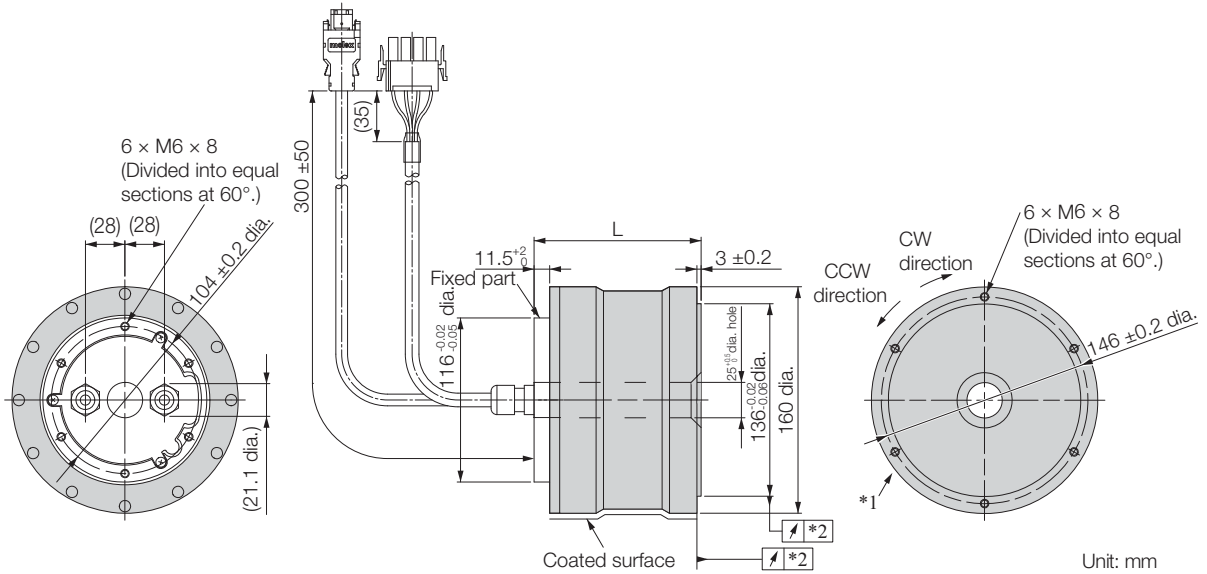

*1. The shaded section indicates the rotating parts.

*2. The precision depends on the option specification. Refer to the following section for details.

Specifications (page 119)

Note: Values in parentheses are reference dimensions.

Model SGM7D-	L	Approx. Mass [kg]
08G□C□□	92.5 ±1	5.5
18G□C□□	118 ±1	7.5
24G□C□□	143 ±1	9.5
34G□C□□	168 ±1	12
45G□C□□	194 ±1	14

■ Connector Specifications

• Servomotor Connector



1	Phase U	Red
2	Phase V	Gray
3	Phase W	Blue
4	FG (frame ground)	Green (yellow)

Models

- Plug: 350779-1
 - Pins: 350218-3 or 350547-3 (No.1 to 3)
 - Ground pin: 350654-1 or 350669-1 (No. 4)
- Manufacturer: Tyco Electronics Japan G.K.

Mating Connector

- Cap: 350780-1
- Socket: 350536-3 or 350550-3

• Encoder Connector

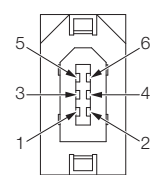

1	PG5V
2	PG0V
3*	BAT
4*	BAT0
5	PS
6	/PS
Connector case	FG (frame ground)

* Only absolute-value models with multiturn data.

Model: 55102-0600

Manufacturer: Molex Japan LLC

Mating connector: 54280-0609

◆ SGM7D-03H

• Servomotors with the Cable on the Side

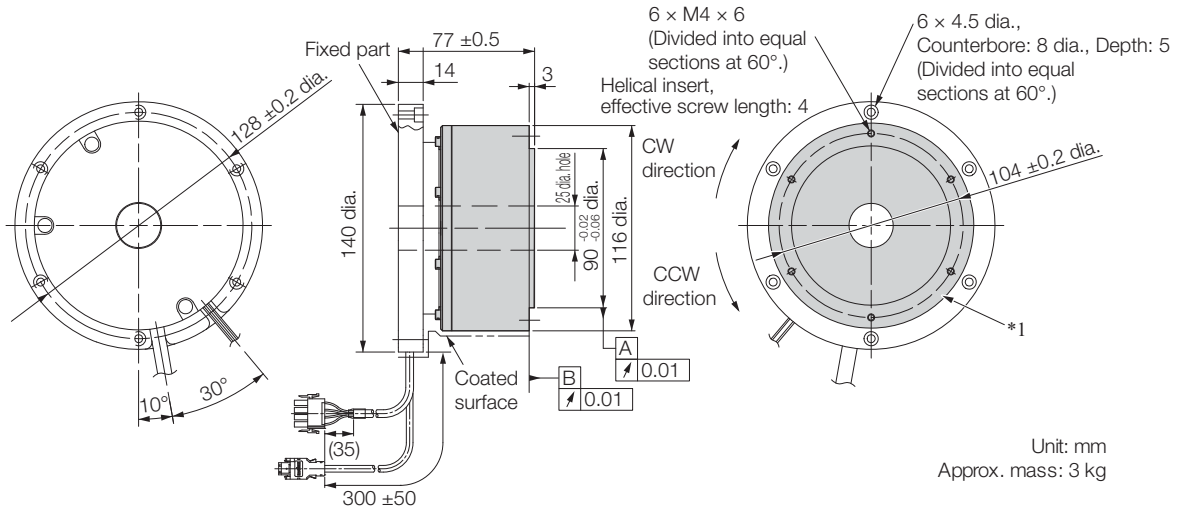

* The shaded section indicates the rotating parts.
Note: Values in parentheses are reference dimensions.

■ Connector Specifications

• Servomotor Connector

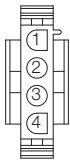

1	Phase U	Red
2	Phase V	Gray
3	Phase W	Blue
4	FG (frame ground)	Green

Models

- Plug: 350779-1
- Pins: 350561-3 or 350690-3 (No.1 to 3)
- Ground pin: 350654-1 or 350669-1 (No. 4)
- Manufacturer: Tyco Electronics Japan G.K.

Mating Connector

- Cap: 350780-1
- Socket: 350570-3 or 350689-3

• Encoder Connector

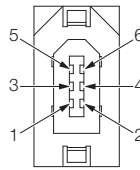

1	PG5V
2	PG0V
3*	BAT
4*	BAT0
5	PS
6	/PS
Connector case	FG (frame ground)

* Only absolute-value models with multiturn data.

Model: 55102-0600

Manufacturer: Molex Japan LLC

Mating connector: 54280-0609

◆ SGM7D-□□□

• Servomotors with the Cable on the Bottom

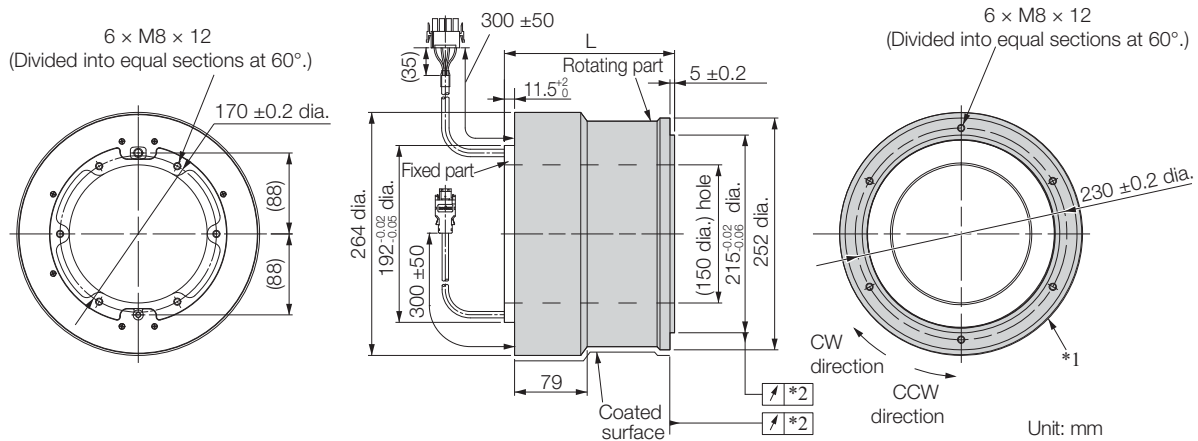

*1. The shaded section indicates the rotating parts.

*2. The precision depends on the option specification. Refer to the following section for details.

📖 Specifications (page 119)

Note: Values in parentheses are reference dimensions.

Model SGM7D-	L	Approx. Mass [kg]
28I□C5□	158 ± 1	23
70I□C5□	185 ± 1	28
1ZI□C5□	212 ± 1	33
1CI□C5□	250 ± 1	45
2BI□C5□	304 ± 1	55
2DI□C5□	358 ± 1	65

■ Connector Specifications

• Servomotor Connector

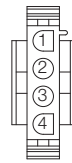

Pin No.	Phase	Color
1	Phase U	Red
2	Phase V	Gray
3	Phase W	Blue
4	FG (frame ground)	Green (yellow)

Models

- Plug: 350779-1
- Pins: 350218-3 or 350547-3 (No.1 to 3)
- Ground pin: 350654-1 or 350669-1 (No. 4)
- Manufacturer: Tyco Electronics Japan G.K.

Mating Connector

- Cap: 350780-1
- Socket: 350536-3 or 350550-3

• Encoder Connector

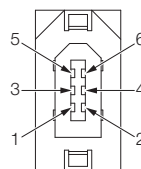

Pin No.	Signal
1	PG5V
2	PG0V
3*	BAT
4*	BATO
5	PS
6	/PS
Connector case	FG (frame ground)

* Only absolute-value models with multiturn data.

Model: 55102-0600

Manufacturer: Molex Japan LLC

Mating connector: 54280-0609

◆ SGM7D-06J

• Servomotors with the Cable on the Bottom

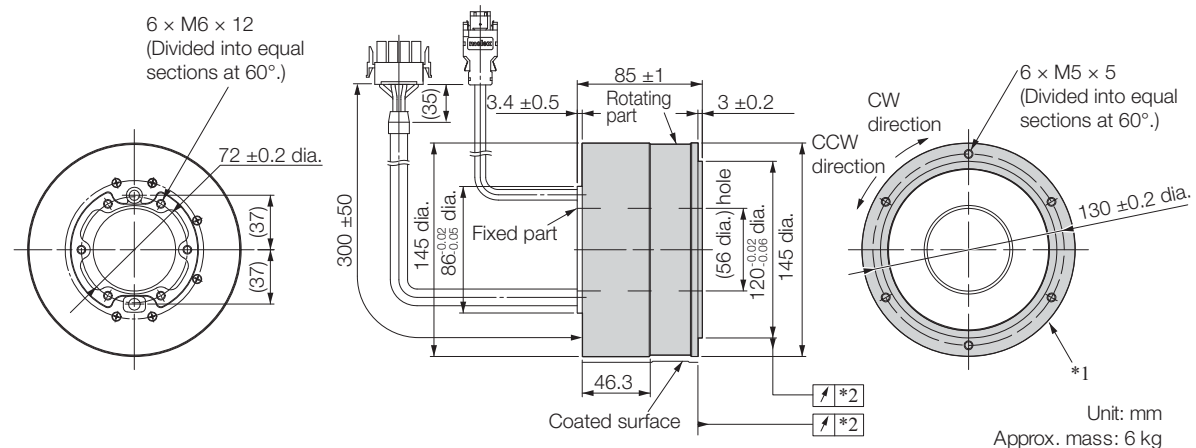

*1. The shaded section indicates the rotating parts.

*2. The precision depends on the option specification. Refer to the following section for details.

📖 Specifications (page 119)

Note: Values in parentheses are reference dimensions.

◆ SGM7D-09J, -18J, -20J, and -38J

• Servomotors with the Cable on the Bottom

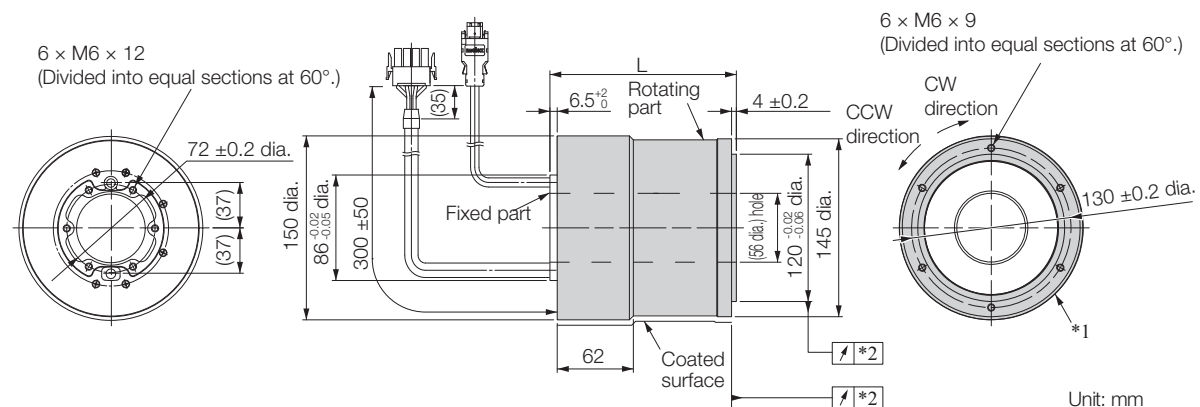

*1. The shaded section indicates the rotating parts.

*2. The precision depends on the option specification. Refer to the following section for details.

📖 Specifications (page 119)

Note: Values in parentheses are reference dimensions.

Model SGM7D-	L	Approx. Mass [kg]
09J□C5□	123 ±1	8.0
18J□C5□	151 ±1	11.0
20J□C5□	179 ±1	13.0
38J□C5□	207 ±1	15.5

■ Connector Specifications

• Servomotor Connector

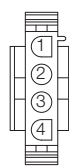

1	Phase U	Red
2	Phase V	Gray
3	Phase W	Blue
4	FG (frame ground)	Green (yellow)

Models

- Plug: 350779-1
- Pins: 350218-3 or 350547-3 (No.1 to 3)
- Ground pin: 350654-1 or 350669-1 (No. 4)

Manufacturer: Tyco Electronics Japan G.K.

Mating Connector

- Cap: 350780-1
- Socket: 350536-3 or 350550-3

• Encoder Connector

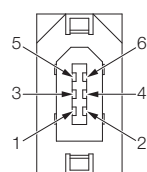

1	PG5V
2	PG0V
3*	BAT
4*	BAT0
5	PS
6	/PS
Connector case	FG (frame ground)

* Only absolute-value models with multiturn data.

Model: 55102-0600

Manufacturer: Molex Japan LLC

Mating connector: 54280-0609

◆ SGM7D-□□K

• Servomotors with the Cable on the Bottom

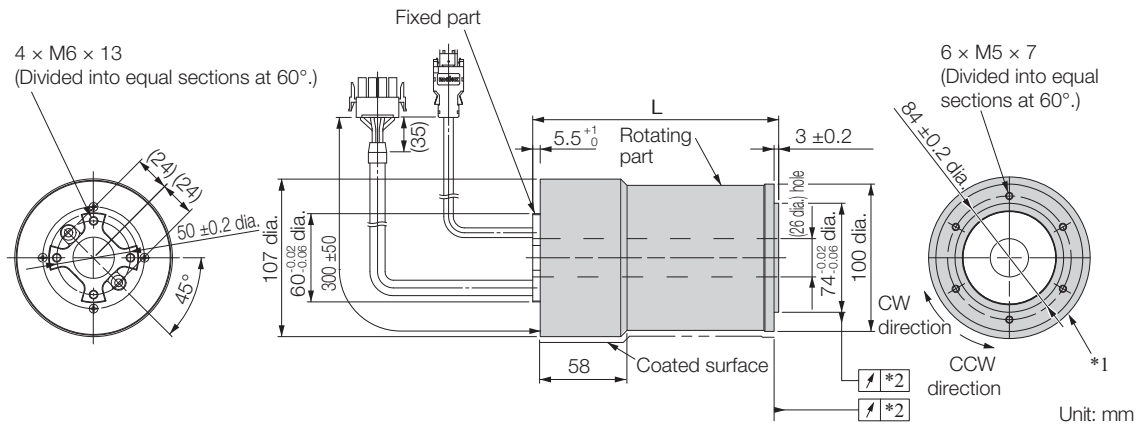

- *1. The shaded section indicates the rotating parts.
- *2. The precision depends on the option specification. Refer to the following section for details.

📖 Specifications (page 119)

Note: Values in parentheses are reference dimensions.

Model SGM7D-	L	Approx. Mass [kg]
02K□C5□	113 ± 1	4.0
06K□C5□	140 ± 1	5.0
08K□C5□	167 ± 1	6.5

■ Connector Specifications

• Servomotor Connector

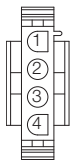

1	Phase U	Red
2	Phase V	Gray
3	Phase W	Blue
4	FG (frame ground)	Green

Models

- Plug: 350779-1
- Pins: 350561-3 or 350690-3 (No.1 to 3)
- Ground pin: 350654-1 or 350669-1 (No. 4)
- Manufacturer: Tyco Electronics Japan G.K.

Mating Connector

- Cap: 350780-1
- Socket: 350570-3 or 350689-3

• Encoder Connector

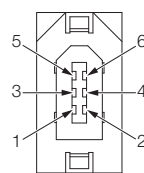

1	PG5V
2	PG0V
3*	BAT
4*	BAT0
5	PS
6	/PS
Connector case	FG (frame ground)

* Only absolute-value models with multiturn data.

Model: 55102-0600

Manufacturer: Molex Japan LLC

Mating connector: 54280-0609

◆ SGM7D-06L and -12L

- Servomotors with the Cable on the Side

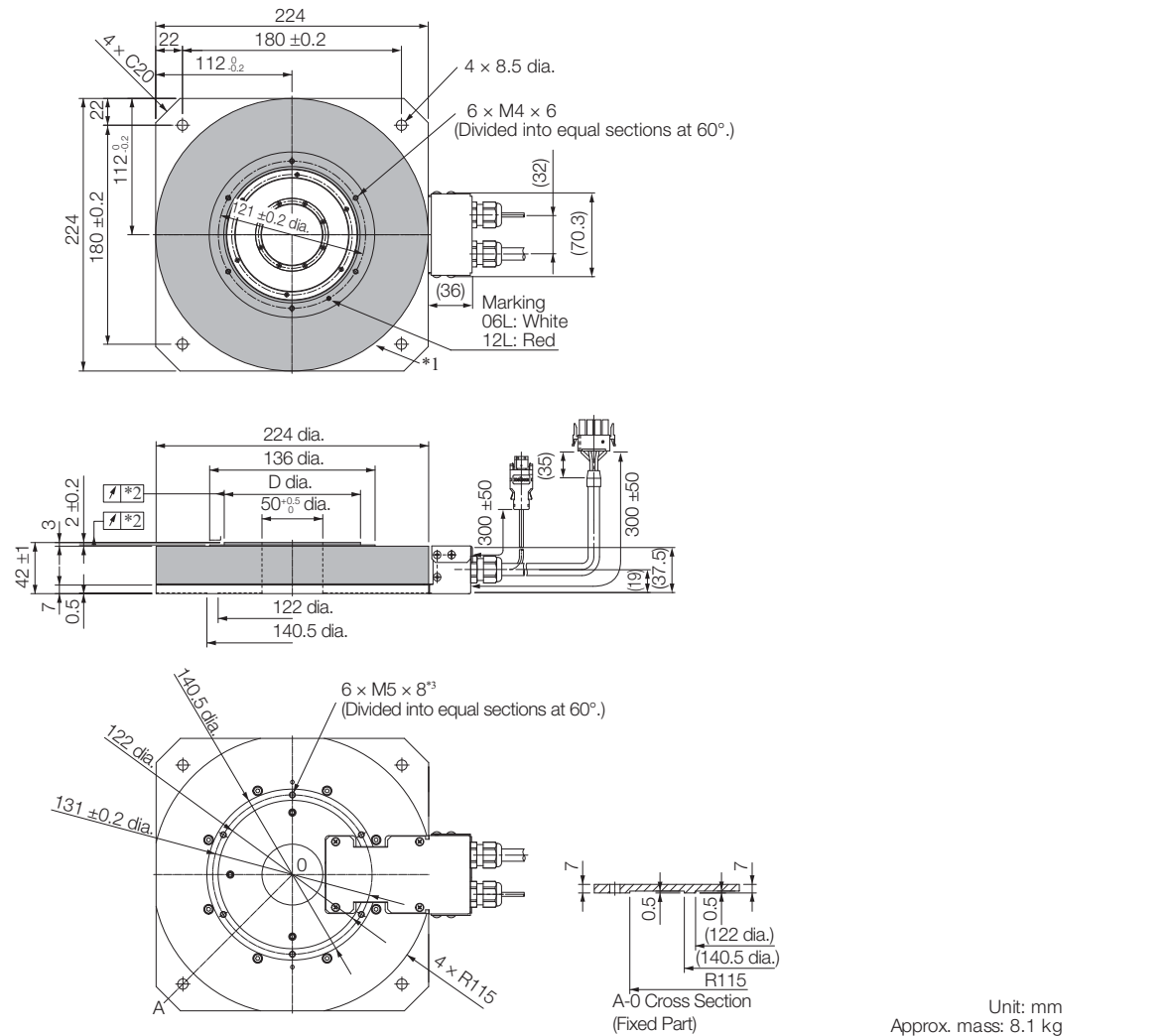

- *1. The shaded section indicates the rotating parts.
- *2. The precision depends on the option specification. Refer to the following section for details.
- *3. In the following cases, rigidity is required in the Servomotor. Therefore, secure the Servomotor with these holes.
 - There is a fluctuating vertical load on the Servomotor.
 - There is a moment load on the Servomotor.
 - The Servomotor is used hanging upside down.

Note: Values in parentheses are reference dimensions.

Model SGM7D-	D
□□□□C41 (Standard mechanical precision)	112 ^{-0.02} _{-0.06}
□□□□C42 (High mechanical precision)	111.9 ^{-0.02} _{-0.06}

■ Connector Specifications

• Servomotor Connector

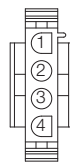

1	Phase U	Red
2	Phase V	Gray
3	Phase W	Blue
4	FG (frame ground)	Green (yellow)

Models

- Plug: 350779-1
- Pins: 350218-3 or 350547-3 (No.1 to 3)
- Ground pin: 350654-1 or 350669-1 (No. 4)
- Manufacturer: Tyco Electronics Japan G.K.

Mating Connector

- Cap: 350780-1
- Socket: 350536-3 or 350550-3

• Encoder Connector

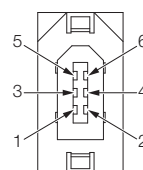

1	PG5V
2	PG0V
3*	BAT
4*	BAT0
5	PS
6	/PS
Connector case	FG (frame ground)

* Only absolute-value models with multiturn data.

Model: 55102-0600
Manufacturer: Molex Japan LLC
Mating connector: 54280-0609

◆ SGM7D-30L

• Servomotors with the Cable on the Side

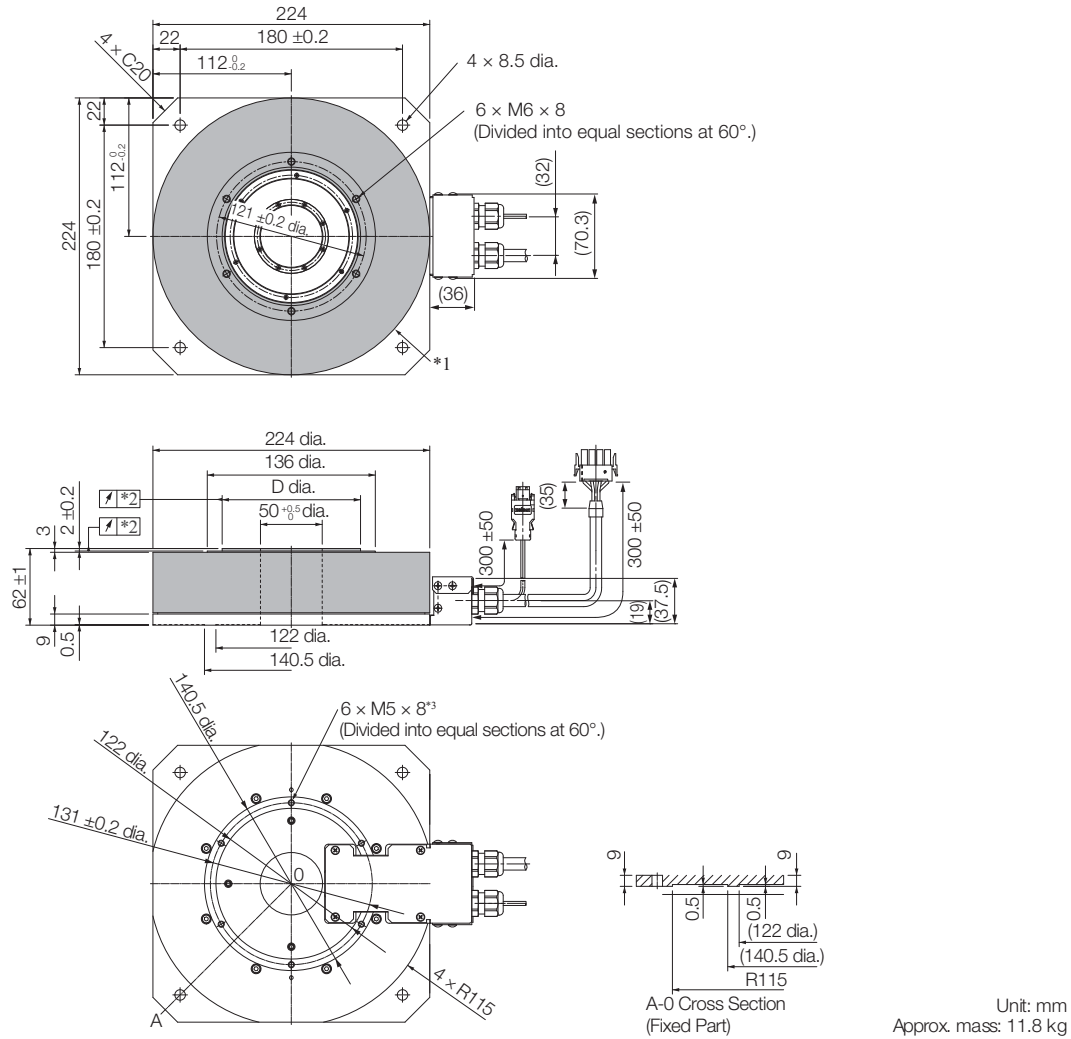

- *1. The shaded section indicates the rotating parts.
- *2. The precision depends on the option specification. Refer to the following section for details.
Specifications (page 119)
- *3. In the following cases, rigidity is required in the Servomotor. Therefore, secure the Servomotor with these holes.
 - There is a fluctuating vertical load on the Servomotor.
 - There is a moment load on the Servomotor.
 - The Servomotor is used hanging upside down.

Note: Values in parentheses are reference dimensions.

Model SGM7D-	D
30L□C41 (Standard mechanical precision)	112 ^{-0.02} _{-0.06}
30L□C42 (High mechanical precision)	111.9 ^{-0.02} _{-0.06}

■ Connector Specifications

• Servomotor Connector

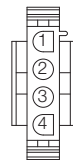

1	Phase U	Red
2	Phase V	Gray
3	Phase W	Blue
4	FG (frame ground)	Green (yellow)

Models

- Plug: 350779-1
- Pins: 350218-3 or 350547-3 (No.1 to 3)
- Ground pin: 350654-1 or 350669-1 (No. 4)
- Manufacturer: Tyco Electronics Japan G.K.

Mating Connector

- Cap: 350780-1
- Socket: 350536-3 or 350550-3

• Encoder Connector

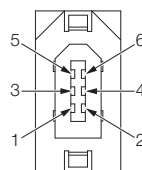

1	PG5V
2	PG0V
3*	BAT
4*	BAT0
5	PS
6	/PS
Connector case	FG (frame ground)

* Only absolute-value models with multiturn data.
 Model: 55102-0600
 Manufacturer: Molex Japan LLC
 Mating connector: 54280-0609

Selecting Cables

◆ Cable Configurations

The cables shown below are required to connect a Servomotor to a SERVOPACK.

Encoder Cable of 20 m or Less

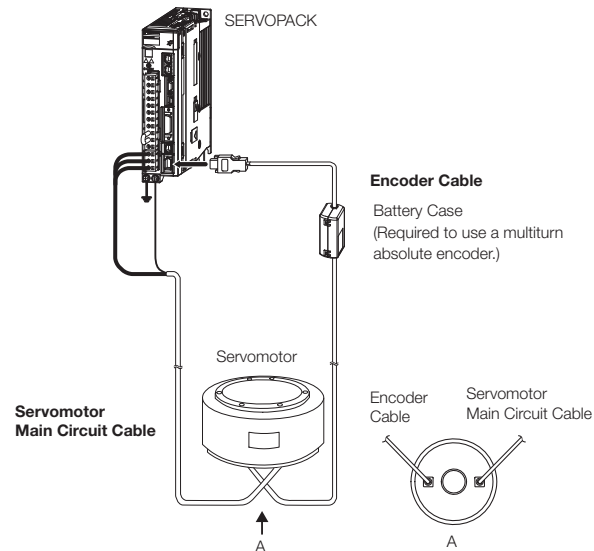

Encoder Cable of 30 m to 50 m (Relay Cable)

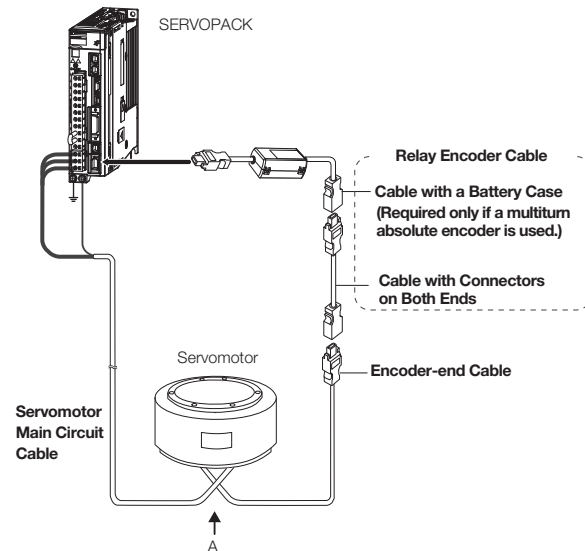

Note: 1. If the Encoder Cable length exceeds 20 m, be sure to use a Relay Encoder Cable.

2. If you use a Servomotor Main Circuit Cable that exceeds 20 m, the intermittent duty zone in the torque-motor speed characteristics will become smaller because the voltage drop increases.

3. Refer to the following manual for the following information.

- Cable dimensional drawings and cable connection specifications
- Order numbers and specifications of individual connectors for cables
- Order numbers and specifications for wiring materials

📖 *Σ-7-Series AC Servo Drive Peripheral Device Selection Manual (Manual No.: SIEP S800001 32)*

◆ Servomotor Main Circuit Cables

Servomotor Model	Length (L)	Order Number		Appearance
		Standard Cable	Flexible Cable*	
SGM7D-□□F SGM7D-08G to -45G SGM7D-□□I SGM7D-□□J SGM7D-□□L	3 m	JZSP-CMM00-03-E	JZSP-C7DM21-03-E	
	5 m	JZSP-CMM00-05-E	JZSP-C7DM21-05-E	
	10 m	JZSP-CMM00-10-E	JZSP-C7DM21-10-E	
	15 m	JZSP-CMM00-15-E	JZSP-C7DM21-15-E	
	20 m	JZSP-CMM00-20-E	JZSP-C7DM21-20-E	
SGM7D-01G or -05G SGM7D-□□H SGM7D-□□K	3 m	JZSP-CMM00-03-E	JZSP-CMM01-03-E	
	5 m	JZSP-CMM00-05-E	JZSP-CMM01-05-E	
	10 m	JZSP-CMM00-10-E	JZSP-CMM01-10-E	
	20 m	JZSP-CMM00-20-E	JZSP-CMM01-20-E	

* Use Flexible Cables for moving parts of machines, such as robots. The recommended bending radius (R) is 90 mm or larger.

Note: Direct Drive Servomotors are not available with holding brakes.

◆ Encoder Cables of 20 m or Less

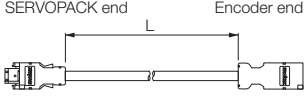
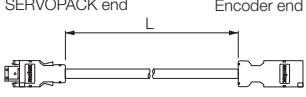
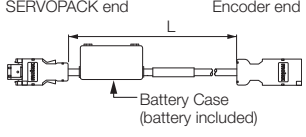
Servomotor Model	Name	Length (L)	Order Number		Appearance
			Standard Cable	Flexible Cable* ¹	
All SGM7D models	For incremental encoder: Without Battery Case	3 m	JZSP-CMP00-03-E	JZSP-CMP10-03-E	
		5 m	JZSP-CMP00-05-E	JZSP-CMP10-05-E	
		10 m	JZSP-CMP00-10-E	JZSP-CMP10-10-E	
		15 m	JZSP-CMP00-15-E	JZSP-CMP10-15-E	
		20 m	JZSP-CMP00-20-E	JZSP-CMP10-20-E	
	For multi-turn absolute encoder: Without Battery Case* ²	3 m	JZSP-CMP00-03-E	JZSP-CMP10-03-E	
		5 m	JZSP-CMP00-05-E	JZSP-CMP10-05-E	
		10 m	JZSP-CMP00-10-E	JZSP-CMP10-10-E	
		15 m	JZSP-CMP00-15-E	JZSP-CMP10-15-E	
		20 m	JZSP-CMP00-20-E	JZSP-CMP10-20-E	
	For multi-turn absolute encoder: With Battery Case	3 m	JZSP-CSP19-03-E	JZSP-CSP29-03-E	
		5 m	JZSP-CSP19-05-E	JZSP-CSP29-05-E	
		10 m	JZSP-CSP19-10-E	JZSP-CSP29-10-E	
		15 m	JZSP-CSP19-15-E	JZSP-CSP29-15-E	
		20 m	JZSP-CSP19-20-E	JZSP-CSP29-20-E	

*1. Use Flexible Cables for moving parts of machines, such as robots. The recommended bending radius (R) is 68 mm or larger.

*2. Use one of these Cables if a battery is connected to the host controller.

◆ Relay Encoder Cables of 30 m to 50 m

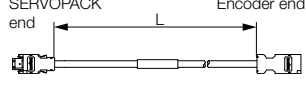
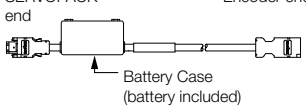
Servomotor Model	Name	Length (L)	Order Number* ¹	Appearance
All SGM7D models	Cables with Connectors on Both Ends (for incremental or multi-turn absolute encoder)	30 m	JZSP-UCMP00-30-E	
		40 m	JZSP-UCMP00-40-E	
		50 m	JZSP-UCMP00-50-E	
	Cable with a Battery Case (for multi-turn absolute encoder)* ²	0.3 m	JZSP-CSP12-E	

*1. Flexible Cables are not available.

*2. This Cable is not required if a battery is connected to the host controller.

SGM7E (Coreless, Inner Rotor)

Model Designations

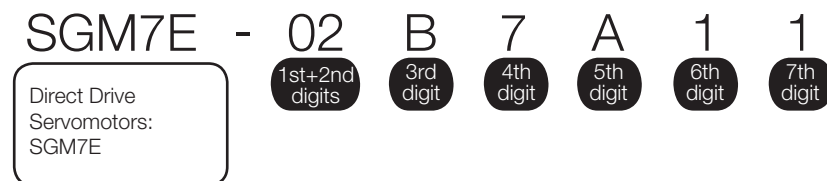

1st+2nd digits Rated Output

Code	Specification
02	2.00 N·m
04	4.00 N·m
05	5.00 N·m
07	7.00 N·m
08	8.00 N·m
10	10.0 N·m
14	14.0 N·m
16	16.0 N·m
17	17.0 N·m
25	25.0 N·m
35	35.0 N·m

3rd digit Servomotor Outer Diameter

Code	Specification
B	135-mm dia.
C	175-mm dia.
D	230-mm dia.
E	290-mm dia.

4th digit Serial Encoder

Code	Specification
7	24-bit multiturn absolute encoder*
F	24-bit incremental encoder*

* Both multiturn absolute encoder and incremental encoder can be used as a single-turn absolute encoder by setting parameters.

5th digit Design Revision Order

A

6th digit Flange

Code	Mounting
1	Non-load side
4	Non-load side (with cable on side)

7th digit Options

Code	Specification
1	Without options
2	High machine precision (runout at end of shaft and runout of shaft surface: 0.01 mm)

Note: 1. Direct Drive Servomotors are not available with holding brakes.

2. This information is provided to explain model numbers. It is not meant to imply that models are available for all combinations of codes.

◆ Manufactured Models

Rated Torque N·m	Servomotor Outer Diameter			
	B (135-mm dia.)	C (175-mm dia.)	D (230-mm dia.)	E (290-mm dia.)
2.00	SGM7E-02B	-	-	-
4.00	-	SGM7E-04C	-	-
5.00	SGM7E-05B	-	-	-
7.00	SGM7E-07B	-	-	-
8.00	-	-	SGM7E-08D	-
10.0	-	SGM7E-10C	-	-
14.0	-	SGM7E-14C	-	-
16.0	-	-	-	SGM7E-16E
17.0	-	-	SGM7E-17D	-
25.0	-	-	SGM7E-25D	-
35.0	-	-	-	SGM7E-35E

Note: The above table shows combinations of the rated torque and outer diameter. The fourth through seventh digits have been omitted.

Specifications and Ratings

Specifications

Voltage		200 V										
Model SGM7E-		02B	05B	07B	04C	10C	14C	08D	17D	25D	16E	35E
Time Rating		Continuous										
Thermal Class		A										
Insulation Resistance		500 VDC, 10 MΩ min.										
Withstand Voltage		1,500 VAC for 1 minute										
Excitation		Permanent magnet										
Mounting		Flange-mounted										
Drive Method		Direct drive										
Rotation Direction		Counterclockwise (CCW) for forward reference when viewed from the load side										
Vibration Class*1		V15										
Absolute Accuracy		±15 s										
Repeatability		±1.3 s										
Protective Structure*2		Totally enclosed, self-cooled, IP42 (The protective structure is IP40 for CE Marking.)										
Environmental Conditions	Surrounding Air Temperature	0°C to 40°C (with no freezing)										
	Surrounding Air Humidity	20% to 80% relative humidity (with no condensation)										
	Installation Site	<ul style="list-style-type: none"> • Must be indoors and free of corrosive and explosive gases. • Must be well-ventilated and free of dust and moisture. • Must facilitate inspection and cleaning. • Must have an altitude of 1,000 m or less. • Must be free of strong magnetic fields. 										
	Storage Environment	Store the Servomotor in the following environment if you store it with the power cable disconnected. Storage Temperature: -20°C to 60°C (with no freezing) Storage Humidity: 20% to 80% relative humidity (with no condensation)										
Mechanical Tolerances*3	Runout of Output Shaft Surface	mm	0.02 (0.01 for high machine precision option)									
	Runout at End of Output Shaft	mm	0.04 (0.01 for high machine precision option)									
	Parallelism between Mounting Surface and Output Shaft Surface	mm	0.07				0.08					
	Concentricity between Output Shaft and Flange Outer Diameter	mm	0.07				0.08					
Shock Resistance*4	Impact Acceleration Rate at Flange	490 m/s ²										
	Number of Impacts	2 times										
Vibration Resistance*4	Vibration Acceleration Rate at Flange	49 m/s ²										
Applicable SERVOPACKs	SGD7S-	2R8A, 2R1F		2R8A, 2R8F						5R5A		
	SGD7W-SGD7C-	2R8A						5R5A				

*1. A vibration class of V15 indicates a vibration amplitude of 15 μm maximum on the Servomotor without a load at the rated motor speed.

*2. The hollow hole section, motor mounting surface, output shaft surface, and gap around the rotating part of the shaft are excluded. Protective structure specifications apply only when the special cable is used.

*3. Refer to the following figure for the relevant locations on the Servomotor. Refer to the dimensional drawings of the individual Servomotors for more information on tolerances.

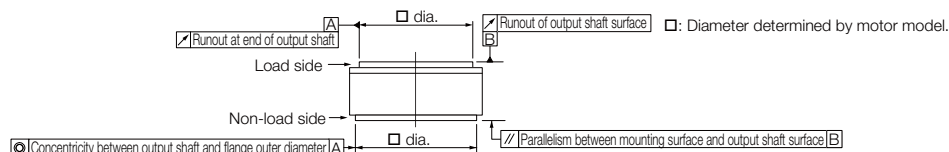

*4. The given values are for when the Servomotor shaft is mounted horizontally and shock or vibration is applied in the directions shown in the following figures. The strength of the vibration that the Servomotor can withstand depends on the application. Check the vibration acceleration rate.

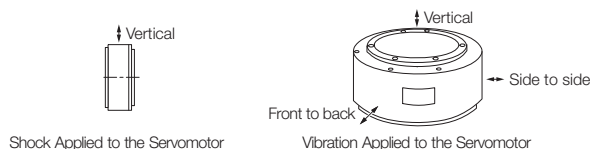

Ratings

Voltage		200 V										
Model SGM7E-		02B	05B	07B	04C	10C	14C	08D	17D	25D	16E	35E
Rated Output* ¹	W	42	105	147	84	209	293	168	356	393	335	550
Rated Torque* ^{1, *2}	N·m	2.00	5.00	7.00	4.00	10.0	14.0	8.00	17.0	25.0	16.0	35.0
Instantaneous Maximum Torque* ¹	N·m	6.00	15.0	21.0	12.0	30.0	42.0	24.0	51.0	75.0	48.0	105
Stall Torque* ¹	N·m	2.05	5.15	7.32	4.09	10.1	14.2	8.23	17.4	25.4	16.5	35.6
Rated Current* ¹	Arms	1.8	1.7	1.4	2.2		2.8	1.9	2.5	2.6	3.3	3.5
Instantaneous Maximum Current* ¹	Arms	5.4	5.1	4.1	7.0		8.3	5.6	7.5	8.0	9.4	10.0
Rated Motor Speed* ¹	min ⁻¹	200			200			200		150	200	150
Maximum Motor Speed* ¹	min ⁻¹	500			500	400	300	500	350	250	500	250
Torque Constant	N·m/Arms	1.18	3.17	5.44	2.04	5.05	5.39	5.10	7.79	10.8	5.58	11.1
Motor Moment of Inertia	×10 ⁻⁴ kg·m ²	28.0	51.0	77.0	77.0	140	220	285	510	750	930	1430
Rated Power Rate* ¹	kW/s	1.43	4.90	6.36	2.08	7.14	8.91	2.25	5.67	8.33	2.75	8.57
Rated Angular Acceleration Rate* ¹	rad/s ²	710	980	910	520	710	640	280	330		170	240
Heat Sink Size	mm	350 × 350 × 12			450 × 450 × 12			550 × 550 × 12			650 × 650 × 12	
Allowable Load Moment of Inertia (Motor Moment of Inertia Ratio)		10 times			5 times	3 times						
	With External Regenerative Resistor and External Dynamic Brake Resistor* ³	10 times			5 times	3 times						
Allowable Load* ⁴	Allowable Thrust Load	N	1500			3300			4000		11000	
	Allowable Moment Load	N·m	40	50	64	70	75	90	93	103	135	250

*1. These values are for operation in combination with a SERVOPACK when the temperature of the armature winding is 100°C. The values for other items are at 20°C. These are typical values.

*2. The rated torques are the continuous allowable torque values at a surrounding air temperature of 40°C with a steel heat sink of the dimensions given in the table.

*3. To externally connect dynamic brake resistor, select hardware option specification 020 for the SERVOPACK. However, you cannot externally connect dynamic brake resistor if you use the following SERVOPACKs (maximum applicable motor capacity: 400 W).

- SGD7S-R70□□□A020 to -2R8□□□A020
- SGD7W-1R6A20A020 to -2R8A20A020
- SGD7C-1R6AMAA020 to -2R8AMAA020

*4. The thrust loads and moment loads that are applied while a Servomotor is operating are roughly classified into the following patterns. Design the machine so that the thrust loads or moment loads will not exceed the values given in the table.

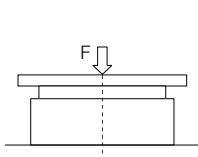

Where F is the external force,
Thrust load = F + Load mass
Moment load = 0

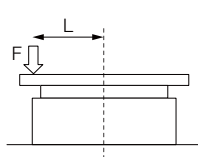

Where F is the external force,
Thrust load = F + Load mass
Moment load = F × L

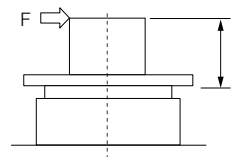

Where F is the external force,
Thrust load = Load mass
Moment load = F × L

Note: For the bearings used in these Servomotors, the loss depends on the bearing temperature. The amount of heat loss is higher at low temperatures.

Torque-Motor Speed Characteristics

A : Continuous duty zone — (solid lines): With three-phase 200-V input
B : Intermittent duty zone - - - (dotted lines): With single-phase 100-V input

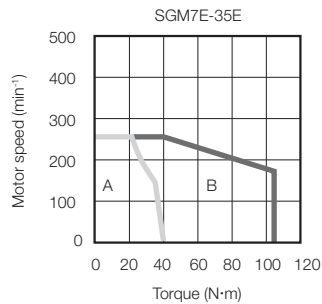
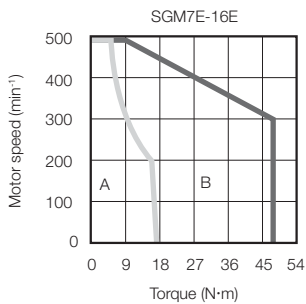
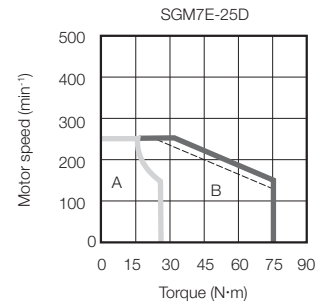
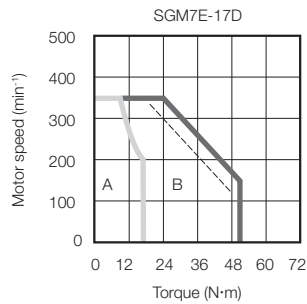
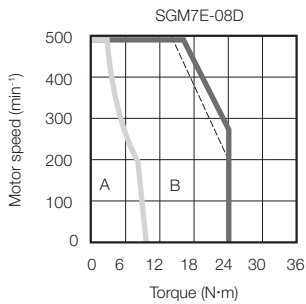
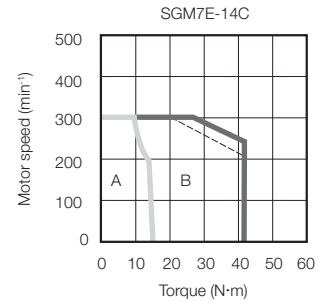
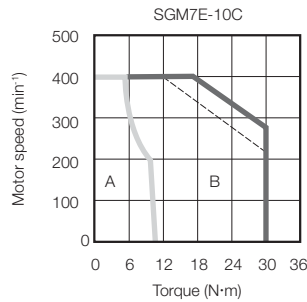
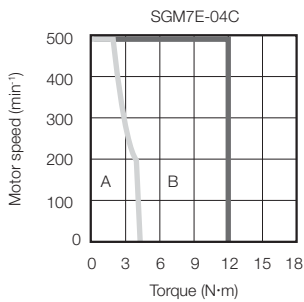
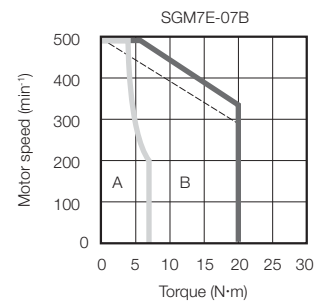
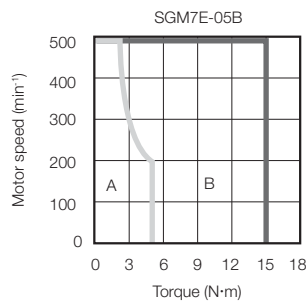
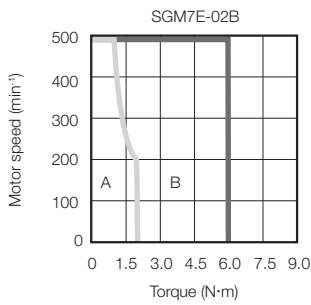

Note: 1. These values (typical values) are for operation in combination with a SERVOPACK when the temperature of the armature winding is 100°C.

2. The characteristics in the intermittent duty zone depend on the power supply voltage.
3. If the effective torque is within the allowable range for the rated torque, the Servomotor can be used within the intermittent duty zone.
4. If you use a Servomotor Main Circuit Cable that exceeds 20 m, the intermittent duty zone in the torque-motor speed characteristics will become smaller because the voltage drop increases.

Servomotor Overload Protection Characteristics

The overload detection level is set for hot start conditions with a Servomotor surrounding air temperature of 40°C.

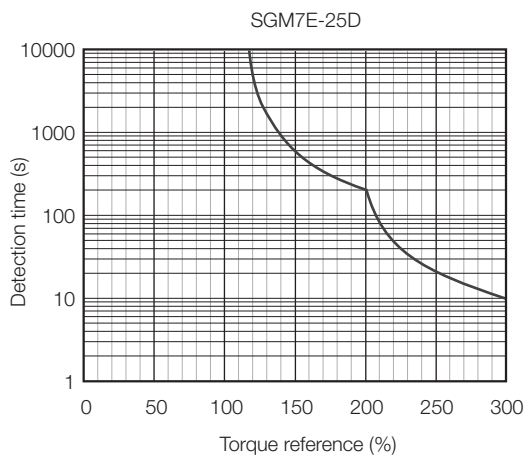
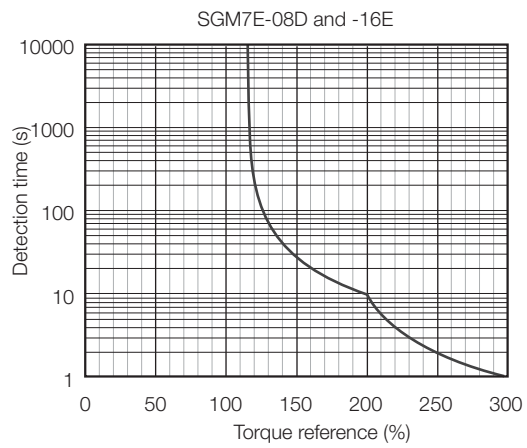
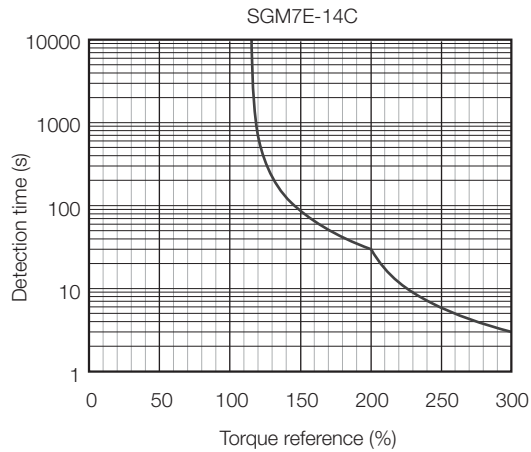
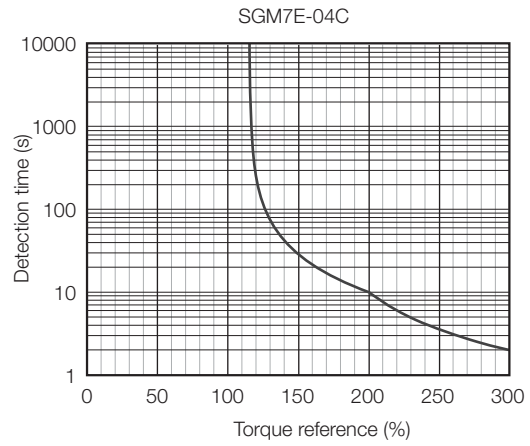
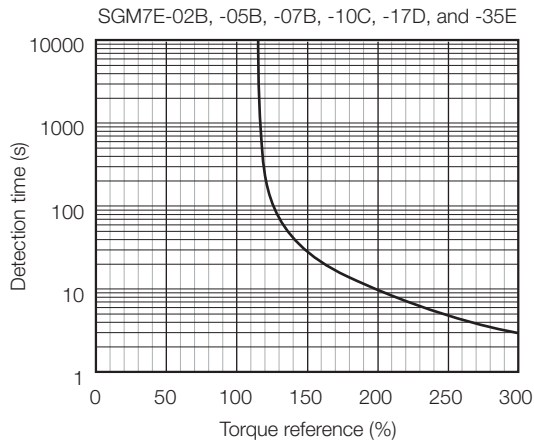

Note: The above overload protection characteristics do not mean that you can perform continuous duty operation with an output of 100% or higher. Use the Servomotor so that the effective torque remains within the continuous duty zone given in *Torque-Motor Speed Characteristics* on page 147.

Allowable Load Moment of Inertia

The allowable load moments of inertia (motor moment of inertia ratios) for the Servomotors are given in the *Ratings* (page 146). The values are determined by the regenerative energy processing capacity of the SERVOPACK and are also affected by the drive conditions of the Servomotor. Perform the required Steps for each of the following cases.

Use the SigmaSize+ AC Servo Drive Capacity Selection Program to check the driving conditions. Contact your Yaskawa representative for information on this program.

◆ Exceeding the Allowable Load Moment of Inertia

Use one of the following measures to adjust the load moment of inertia to within the allowable value.

- Reduce the torque limit.
- Reduce the deceleration rate.
- Reduce the maximum motor speed.

If the above steps is not possible, install an external regenerative resistor.

Information

An Overvoltage Alarm (A.400) is likely to occur during deceleration if the load moment of inertia exceeds the allowable load moment of inertia. SERVOPACKs with a built-in regenerative resistor may generate a Regenerative Overload Alarm (A.320). Refer to *Built-In Regenerative Resistor* (page 472) for the regenerative power (W) that can be processed by the SERVOPACKs.

Install an External Regenerative Resistor when the built-in regenerative resistor cannot process all of the regenerative power.

◆ **SERVOPACKs without Built-in Regenerative Resistors**

The following graph shows the allowable load moment of inertia scaling factor of the motor speed (reference values for deceleration operation at or above the rated torque). Application is possible without an external regenerative resistor within the allowable value. However, an External Regenerative Resistor is required in the shaded areas of the graphs.

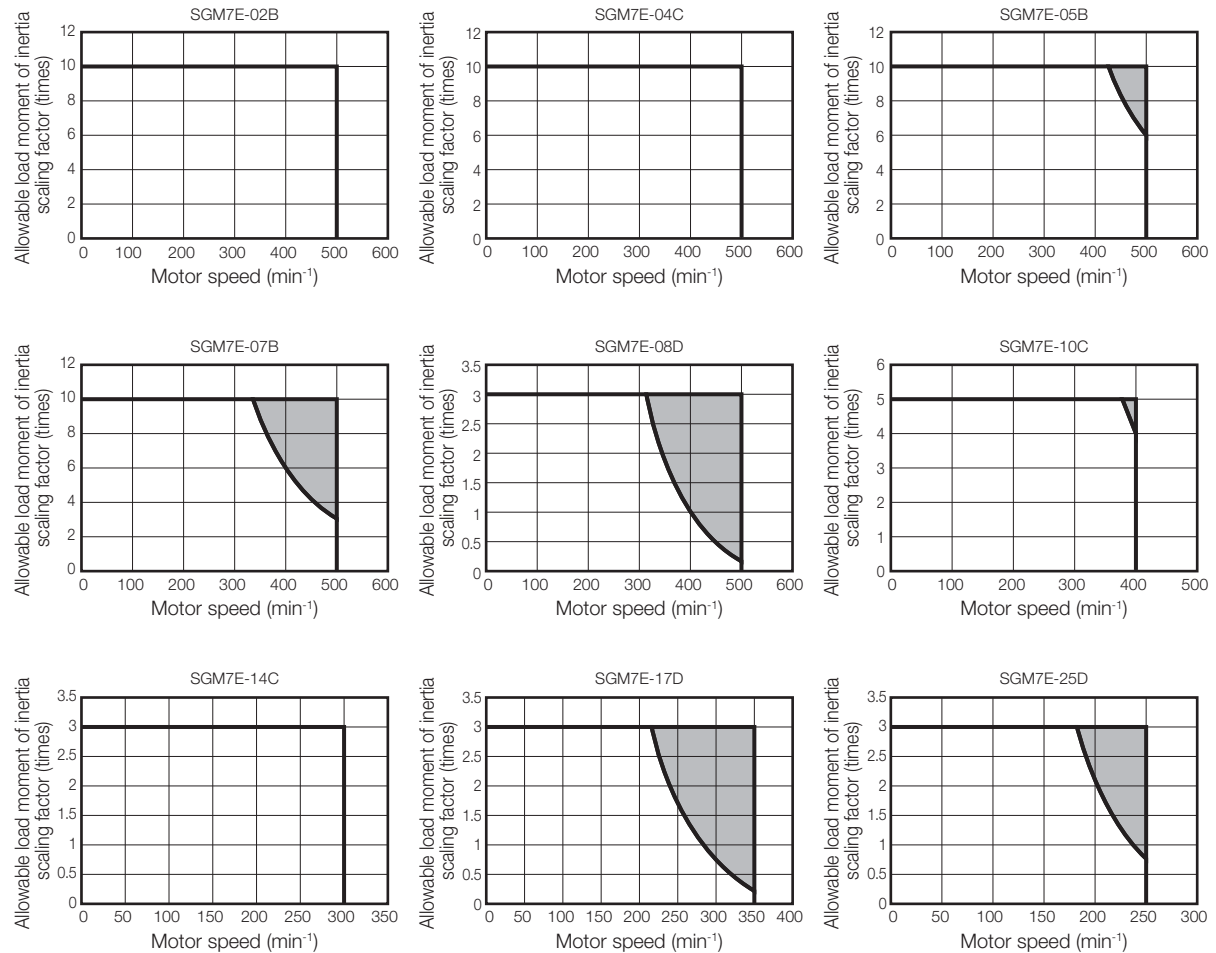

Note: Applicable SERVOPACK models: SGD7S-2R8A and -2R8F

◆ **When an External Regenerative Resistor Is Required**

Install the External Regenerative Resistor. Refer to the following section for the recommended products.

[External Regenerative Resistors \(page 472\)](#)

External Dimensions

◆ SGM7E-□□B

• Flange Specification 1

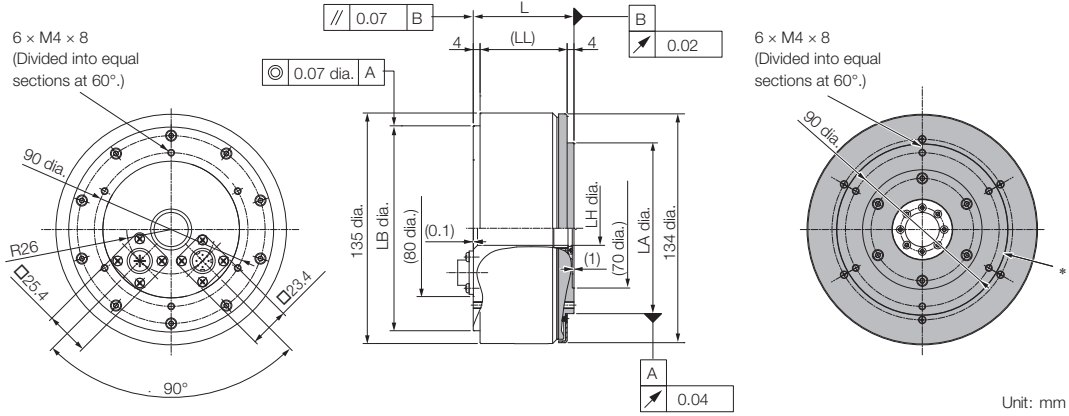

* The shaded section indicates the rotating parts.
Note: Values in parentheses are reference dimensions.

Model SGM7E-	L	(LL)	LB	LH	LA	Approx. Mass [kg]
02B□A11	59	51	120 ⁰ _{-0.035}	20 ^{+0.4} ₀	100 ⁰ _{-0.035}	4.8
05B□A11	88	80	120 ⁰ _{-0.035}	20 ^{+0.4} ₀	100 ⁰ _{-0.035}	5.8
07B□A11	128	120	120 ⁰ _{-0.035}	20 ^{+0.4} ₀	100 ⁰ _{-0.035}	8.2

• Flange Specification 4

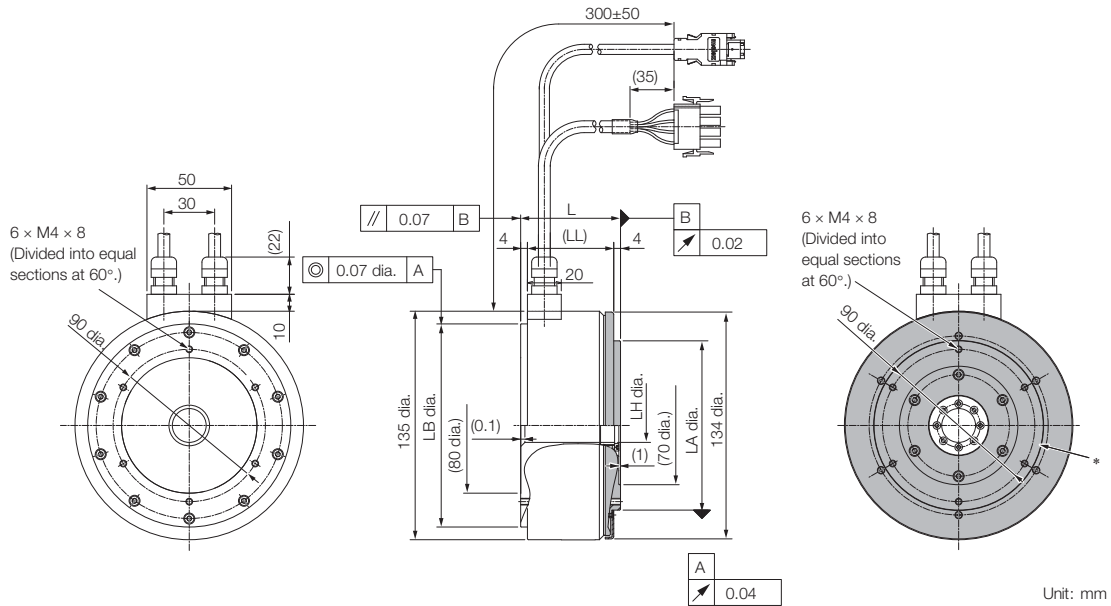

* The shaded section indicates the rotating parts.
Note: Values in parentheses are reference dimensions.

Model SGM7E-	L	(LL)	LB	LH	LA	Approx. Mass [kg]
02B□A41	59	51	120 ⁰ _{-0.035}	20 ^{+0.4} ₀	100 ⁰ _{-0.035}	4.8
05B□A41	88	80	120 ⁰ _{-0.035}	20 ^{+0.4} ₀	100 ⁰ _{-0.035}	5.8
07B□A41	128	120	120 ⁰ _{-0.035}	20 ^{+0.4} ₀	100 ⁰ _{-0.035}	8.2

Refer to the following section for information on connectors.

📖 [Connector Specifications \(page 155\)](#)

◆ SGM7E-□□C

• Flange Specification 1

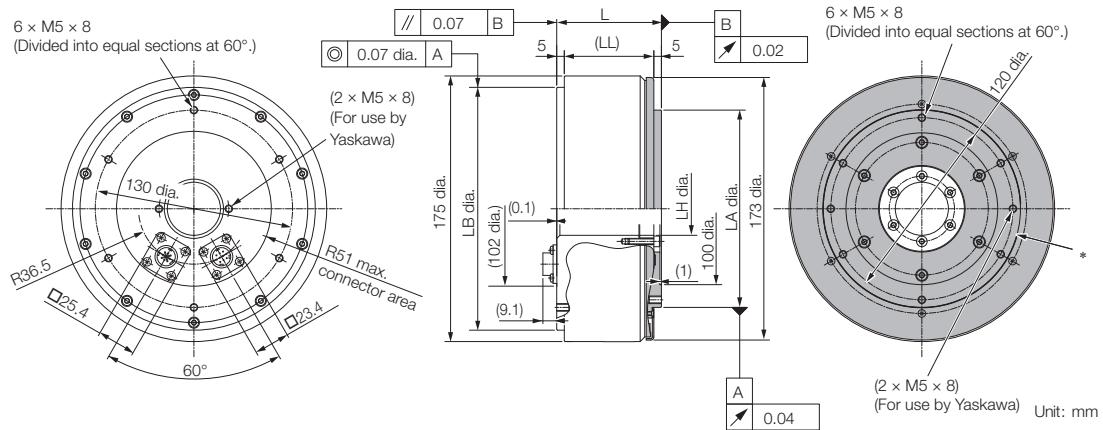

* The shaded section indicates the rotating parts.
Note: Values in parentheses are reference dimensions.

Model SGM7E-	L	(LL)	LB	LH	LA	Approx. Mass [kg]
04C□A11	69	59	160 ⁰ _{-0.040}	35 ^{+0.4} ₀	130 ⁰ _{-0.040}	7.2
10C□A11	90	80	160 ⁰ _{-0.040}	35 ^{+0.4} ₀	130 ⁰ _{-0.040}	10.2
14C□A11	130	120	160 ⁰ _{-0.040}	35 ^{+0.4} ₀	130 ⁰ _{-0.040}	14.2

• Flange Specification 4

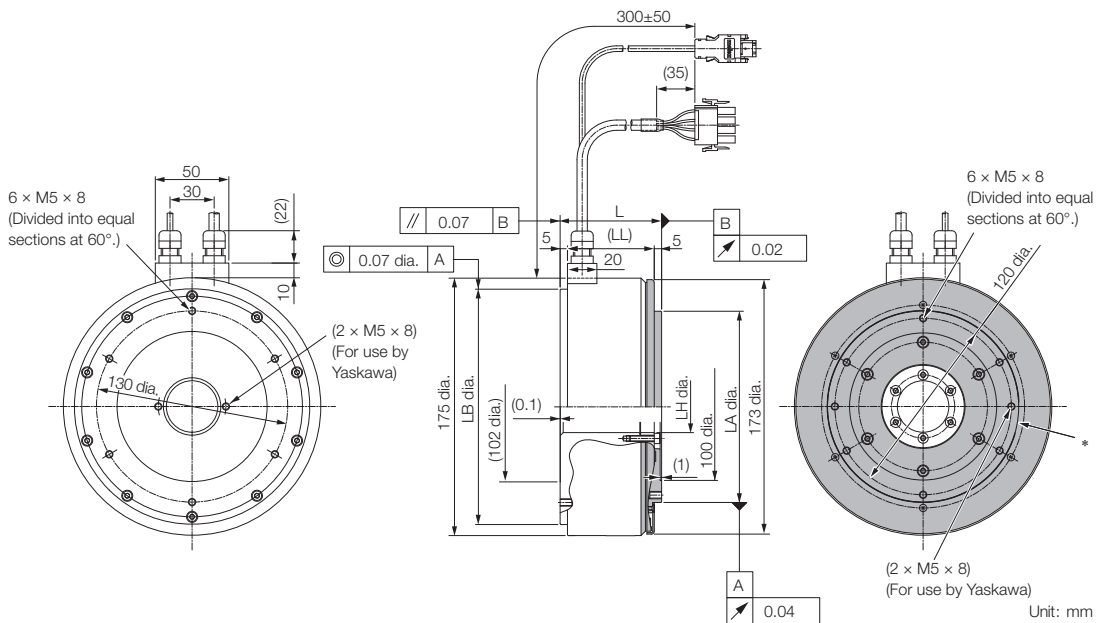

* The shaded section indicates the rotating parts.
Note: Values in parentheses are reference dimensions.

Model SGM7E-	L	(LL)	LB	LH	LA	Approx. Mass [kg]
04C□A41	69	59	160 ⁰ _{-0.040}	35 ^{+0.4} ₀	130 ⁰ _{-0.040}	7.2
10C□A41	90	80	160 ⁰ _{-0.040}	35 ^{+0.4} ₀	130 ⁰ _{-0.040}	10.2
14C□A41	130	120	160 ⁰ _{-0.040}	35 ^{+0.4} ₀	130 ⁰ _{-0.040}	14.2

Refer to the following section for information on connectors.

📖 Connector Specifications (page 155)

◆ SGM7E-□□□

• Flange Specification 1

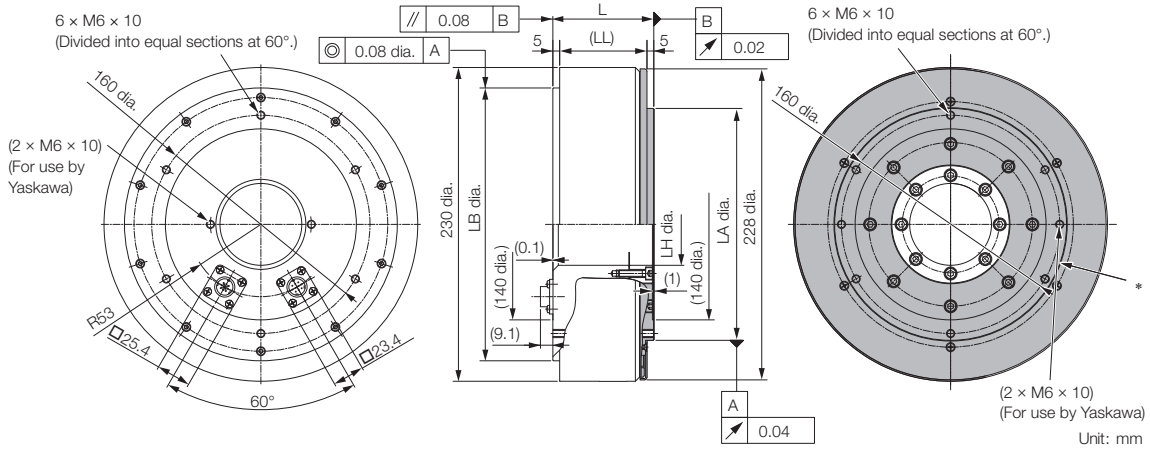

* The shaded section indicates the rotating parts.
Note: Values in parentheses are reference dimensions.

Model SGM7E-	L	(LL)	LB	LH	LA	Approx. Mass [kg]
08D□A11	74	64	200 ⁰ _{-0.046}	60 ^{+0.4} ₀	170 ⁰ _{-0.040}	14.0
17D□A11	110	100	200 ⁰ _{-0.046}	60 ^{+0.4} ₀	170 ⁰ _{-0.040}	22.0
25D□A11	160	150	200 ⁰ _{-0.046}	60 ^{+0.4} ₀	170 ⁰ _{-0.040}	29.7

• Flange Specification 4

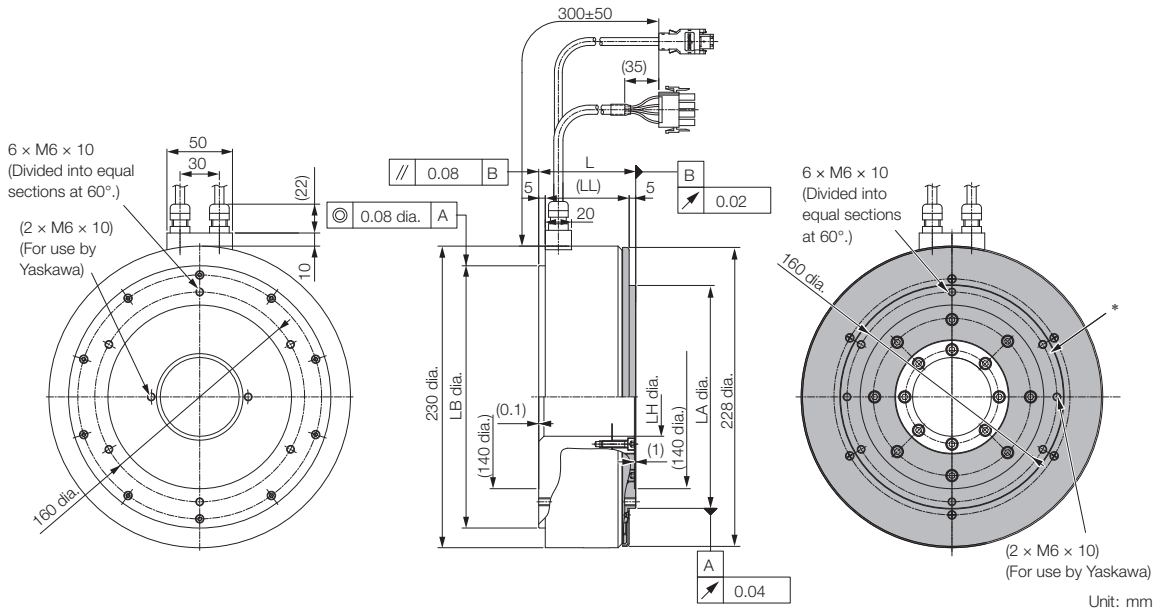

* The shaded section indicates the rotating parts.
Note: Values in parentheses are reference dimensions.

Model SGM7E-	L	(LL)	LB	LH	LA	Approx. Mass [kg]
08D□A41	74	64	200 ⁰ _{-0.046}	60 ^{+0.4} ₀	170 ⁰ _{-0.040}	14.0
17D□A41	110	100	200 ⁰ _{-0.046}	60 ^{+0.4} ₀	170 ⁰ _{-0.040}	22.0
25D□A41	160	150	200 ⁰ _{-0.046}	60 ^{+0.4} ₀	170 ⁰ _{-0.040}	29.7

Refer to the following section for information on connectors.

🔌 Connector Specifications (page 155)

◆ SGM7E-□□E

• Flange Specification 1

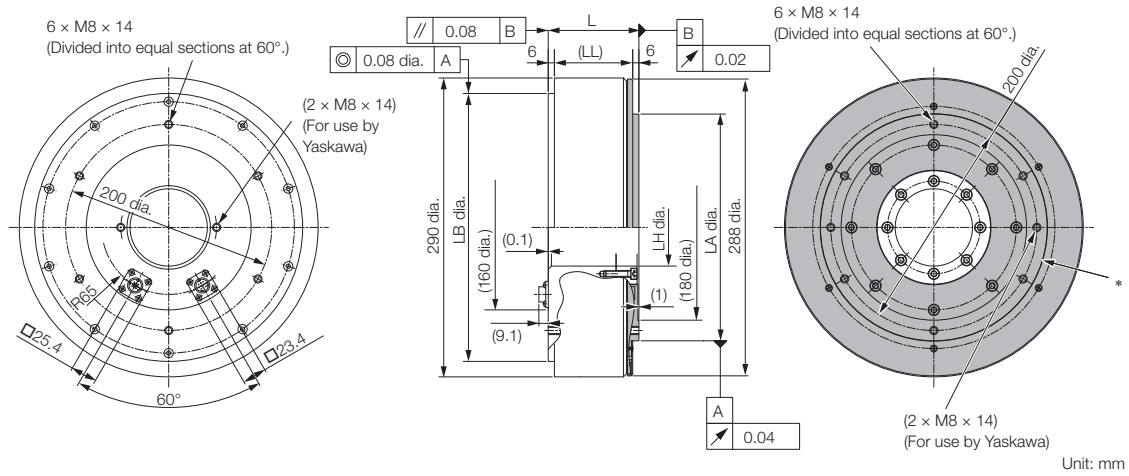

* The shaded section indicates the rotating parts.

Note: Values in parentheses are reference dimensions.

Model SGM7E-	L	(LL)	LB	LH	LA	Approx. Mass [kg]
16E□A11	88	76	260 ⁰ _{-0.052}	75 ^{+0.4} ₀	220 ⁰ _{-0.046}	26.0
35E□A11	112	100	260 ⁰ _{-0.052}	75 ^{+0.4} ₀	220 ⁰ _{-0.046}	34.0

• Flange Specification 4

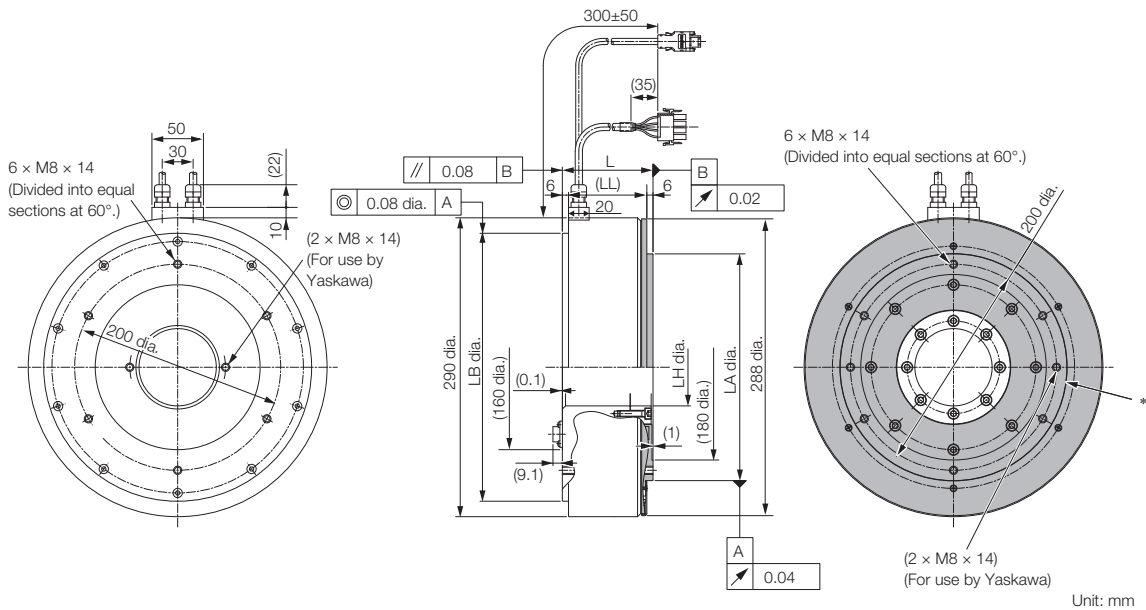

* The shaded section indicates the rotating parts.

Note: Values in parentheses are reference dimensions.

Model SGM7E-	L	(LL)	LB	LH	LA	Approx. Mass [kg]
16E□A41	88	76	260 ⁰ _{-0.052}	75 ^{+0.4} ₀	220 ⁰ _{-0.046}	26.0
35E□A41	112	100	260 ⁰ _{-0.052}	75 ^{+0.4} ₀	220 ⁰ _{-0.046}	34.0

Refer to the following section for information on connectors.

☞ Connector Specifications (page 155)

Connector Specifications

◆ Flange Specification 1

• Servomotor Connector

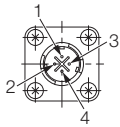

1	Phase U
2	Phase V
3	Phase W
4	FG (frame ground)

Model: JN1AS04MK2R
Manufacturer: Japan Aviation Electronics Industry, Ltd.

Mating connector: JN1DS04FK1
(Not provided by Yaskawa.)

• Encoder Connector

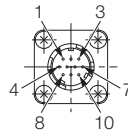

1	PS
2	/PS
3	-
4	PG5V
5*	BAT0
6	-
7	FG (frame ground)
8*	BAT
9	PG0V
10	-

* Only absolute-value models with multiturn data.

Model: JN1AS10ML1-R
Manufacturer: Japan Aviation Electronics Industry, Ltd.

Mating connector: JN1DS10SL1
(Not provided by Yaskawa.)

◆ Flange Specification 4

• Servomotor Connector

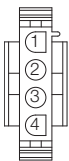

1	Phase U	Red
2	Phase V	White
3	Phase W	Blue
4	FG (frame ground)	Green (yellow)

Models

- Plug: 350779-1
 - Pins: 350561-3 or 350690-3 (No.1 to 3)
 - Ground pin: 350654-1 or 350669-1 (No. 4)
- Manufacturer:** Tyco Electronics Japan G.K.

Mating Connector

- Cap: 350780-1
- Socket: 350570-3 or 350689-3

• Encoder Connector

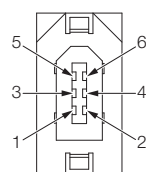

1	PG5V
2	PG0V
3*	BAT
4*	BAT0
5	PS
6	/PS
Connector case	FG (frame ground)

* Only absolute-value models with multiturn data.

Model: 55102-0600
Manufacturer: Molex Japan LLC

Mating connector: 54280-0609

Selecting Cables

◆ Cable Configurations

The cables shown below are required to connect a Servomotor to a SERVOPACK.

Encoder Cable of 20 m or Less

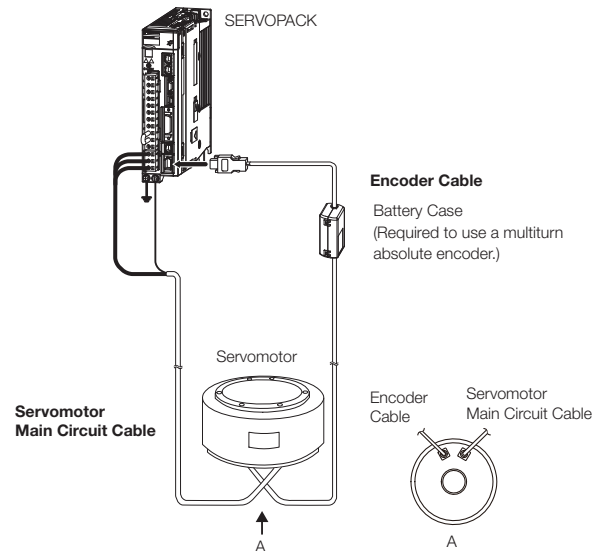

Encoder Cable of 30 m to 50 m (Relay Cable)

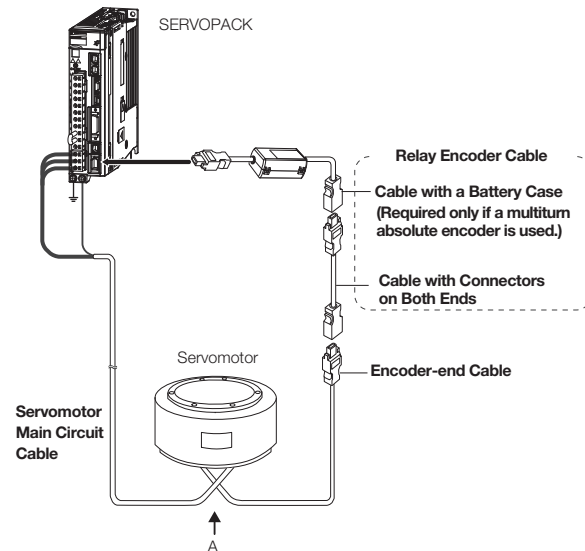

Note: 1. If the Encoder Cable length exceeds 20 m, be sure to use a Relay Encoder Cable.

2. If you use a Servomotor Main Circuit Cable that exceeds 20 m, the intermittent duty zone in the torque-motor speed characteristics will become smaller because the voltage drop increases.

3. Refer to the following manual for the following information.

- Cable dimensional drawings and cable connection specifications
- Order numbers and specifications of individual connectors for cables
- Order numbers and specifications for wiring materials

☞ *Σ-7-Series AC Servo Drive Peripheral Device Selection Manual (Manual No.: SIEP S800001 32)*

◆ Servomotor Main Circuit Cables

Servomotor Model	Length (L)	Order Number		Appearance
		Standard Cable	Flexible Cable*1	
SGM7E-□□□□ Flange specification*2: 1 Non-load side installation	3 m	JZSP-CMM60-03-E	JZSP-C7MDN23-03-E	
	5 m	JZSP-CMM60-05-E	JZSP-C7MDN23-05-E	
	10 m	JZSP-CMM60-10-E	JZSP-C7MDN23-10-E	
	15 m	JZSP-CMM60-15-E	JZSP-C7MDN23-15-E	
	20 m	JZSP-CMM60-20-E	JZSP-C7MDN23-20-E	
SGM7E-□□□□ Flange specification*2: 4 Non-load side installation (with cable on side)	3 m	JZSP-CMM00-03-E	JZSP-C7MDS23-03-E	
	5 m	JZSP-CMM00-05-E	JZSP-C7MDS23-05-E	
	10 m	JZSP-CMM00-10-E	JZSP-C7MDS23-10-E	
	15 m	JZSP-CMM00-15-E	JZSP-C7MDS23-15-E	
	20 m	JZSP-CMM00-20-E	JZSP-C7MDS23-20-E	

*1. Use Flexible Cables for moving parts of machines, such as robots. The recommended bending radius (R) is 90 mm or larger.

*2. Refer to the following section for the flange specifications.

☞ *Model Designations (page 144)*

Note: Direct Drive Servomotors are not available with holding brakes.

◆ Encoder Cables of 20 m or Less

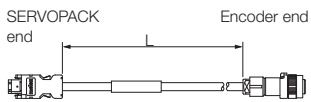
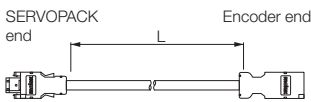
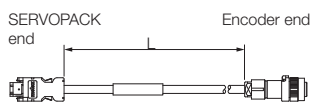
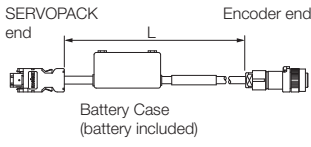
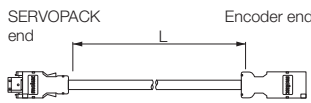
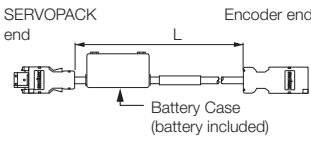
Servomotor Model	Name	Length (L)	Order Number		Appearance
			Standard Cable	Flexible Cable*1	
SGM7E-□□□F Flange specification*2: 1	For incremental encoder	3 m	JZSP-CMP60-03-E	JZSP-CSP60-03-E	
		5 m	JZSP-CMP60-05-E	JZSP-CSP60-05-E	
		10 m	JZSP-CMP60-10-E	JZSP-CSP60-10-E	
		15 m	JZSP-CMP60-15-E	JZSP-CSP60-15-E	
		20 m	JZSP-CMP60-20-E	JZSP-CSP60-20-E	
SGM7E-□□□F Flange specification*2: 4	For incremental encoder	3 m	JZSP-CMP00-03-E	JZSP-CMP10-03-E	
		5 m	JZSP-CMP00-05-E	JZSP-CMP10-05-E	
		10 m	JZSP-CMP00-10-E	JZSP-CMP10-10-E	
		15 m	JZSP-CMP00-15-E	JZSP-CMP10-15-E	
		20 m	JZSP-CMP00-20-E	JZSP-CMP10-20-E	
SGM7E-□□□7 Flange specification*2: 1	For multi-turn absolute encoder (without Battery Case*3)	3 m	JZSP-C7PI00-03-E	JZSP-C7PI20-03-E	
		5 m	JZSP-C7PI00-05-E	JZSP-C7PI20-05-E	
		10 m	JZSP-C7PI00-10-E	JZSP-C7PI20-10-E	
		15 m	JZSP-C7PI00-15-E	JZSP-C7PI20-15-E	
		20 m	JZSP-C7PI00-20-E	JZSP-C7PI20-20-E	
	For multi-turn absolute encoder (with Battery Case)	3 m	JZSP-C7PA00-03-E	JZSP-C7PA20-03-E	
		5 m	JZSP-C7PA00-05-E	JZSP-C7PA20-05-E	
		10 m	JZSP-C7PA00-10-E	JZSP-C7PA20-10-E	
		15 m	JZSP-C7PA00-15-E	JZSP-C7PA20-15-E	
		20 m	JZSP-C7PA00-20-E	JZSP-C7PA20-20-E	
SGM7E-□□□7 Flange specification*2: 4	For multi-turn absolute encoder (without Battery Case*3)	3 m	JZSP-CMP00-03-E	JZSP-CMP10-03-E	
		5 m	JZSP-CMP00-05-E	JZSP-CMP10-05-E	
		10 m	JZSP-CMP00-10-E	JZSP-CMP10-10-E	
		15 m	JZSP-CMP00-15-E	JZSP-CMP10-15-E	
		20 m	JZSP-CMP00-20-E	JZSP-CMP10-20-E	
	For multi-turn absolute encoder (with Battery Case)	3 m	JZSP-CSP19-03-E	JZSP-CSP29-03-E	
		5 m	JZSP-CSP19-05-E	JZSP-CSP29-05-E	
		10 m	JZSP-CSP19-10-E	JZSP-CSP29-10-E	
		15 m	JZSP-CSP19-15-E	JZSP-CSP29-15-E	
		20 m	JZSP-CSP19-20-E	JZSP-CSP29-20-E	

*1. Use Flexible Cables for moving parts of machines, such as robots. The recommended bending radius (R) is 68 mm or larger.

*2. Refer to the following section for the flange specifications.

 Model Designations (page 144)

*3. Use one of these Cables if a battery is connected to the host controller.

◆ Relay Encoder Cables of 30 m to 50 m

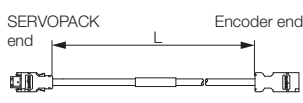
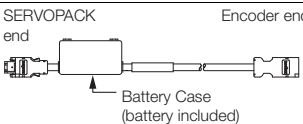
Servomotor Model	Name	Length (L)	Order Number*1	Appearance
SGM7E-□□□F SGM7E-□□□7 Flange specification*2: 1	Encoder-end Cable (for single-turn/multi-turn absolute encoder)	0.3 m	JZSP-C7PRC0-E	
SGM7E-□□□F SGM7E-□□□7 Flange specification*2: 1 or 4	Cables with Connectors on Both Ends (for single-turn/multi-turn absolute encoder)	30 m	JZSP-UCMP00-30-E	
		40 m	JZSP-UCMP00-40-E	
		50 m	JZSP-UCMP00-50-E	
SGM7E-□□□7 Flange specification*2: 1 or 4	Cable with a Battery Case (for multiturn absolute encoder)*3	0.3 m	JZSP-CSP12-E	

*1. Flexible Cables are not available.

*2. Refer to the following section for the flange specifications.

 Model Designations (page 144)

*3. Use one of these Cables if a battery is connected to the host controller.

MEMO

SGM7F (With Core, Inner Rotor)

Model Designations

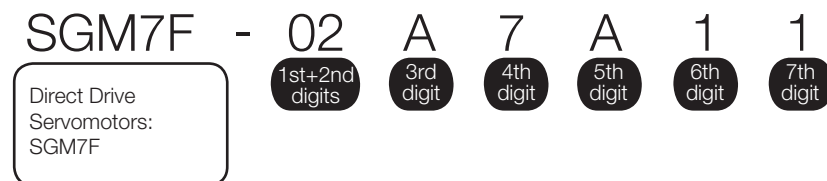

1st+2nd digits Rated Output

• Small-Capacity

Code	Specification
02	2.00 N·m
04	4.00 N·m
05	5.00 N·m
07	7.00 N·m
08	8.00 N·m
10	10.0 N·m
14	14.0 N·m
16	16.0 N·m
17	17.0 N·m
25	25.0 N·m
35	35.0 N·m

• Medium-Capacity

Code	Specification
45	45.0 N·m
80	80.0 N·m
1A	110 N·m
1E	150 N·m
2Z	200 N·m

3rd digit Servomotor Outer Diameter

Code	Specification
A	100-mm dia.
B	135-mm dia.
C	175-mm dia.
D	230-mm dia.
M	280-mm dia.
N	360-mm dia.

4th digit Serial Encoder

Code	Specification
7	24-bit multiturn absolute encoder*
F	24-bit incremental encoder*

* Both multiturn absolute encoder and incremental encoder can be used as a single-turn absolute encoder by setting parameters.

5th digit Design Revision Order

A

6th digit Flange

Code	Mounting	Servomotor Outer Diameter Code (3rd Digit)					
		A	B	C	D	M	N
1	Non-load side	✓	✓	✓	✓	-	-
	Load side	-	-	-	-	✓	✓
3	Non-load side	-	-	-	-	✓	✓
4	Non-load side (with cable on side)	✓	✓	✓	✓	-	-

✓ : Applicable models.

7th digit Options

Code	Specification
1	Without options
2	High machine precision (runout at end of shaft and runout of shaft surface: 0.01 mm)

Note: 1. Direct Drive Servomotors are not available with holding brakes.

2. This information is provided to explain model numbers. It is not meant to imply that models are available for all combinations of codes.

◆ Manufactured Models

Rated Torque N·m	Servomotor Outer Diameter					
	A (100-mm dia.)	B (135-mm dia.)	C (175-mm dia.)	D (230-mm dia.)	M (280-mm dia.)	N (360-mm dia.)
2.00	SGM7F-02A	-	-	-	-	-
4.00	-	SGM7F-04B	-	-	-	-
5.00	SGM7F-05A	-	-	-	-	-
7.00	SGM7F-07A	-	-	-	-	-
8.00	-	-	SGM7F-08C	-	-	-
10.0	-	SGM7F-10B	-	-	-	-
14.0	-	SGM7F-14B	-	-	-	-
16.0	-	-	-	SGM7F-16D	-	-
17.0	-	-	SGM7F-17C	-	-	-
25.0	-	-	SGM7F-25C	-	-	-
35.0	-	-	-	SGM7F-35D	-	-
45.0	-	-	-	-	SGM7F-45M	-
80.0	-	-	-	-	SGM7F-80M	SGM7F-80N
110	-	-	-	-	SGM7F-1AM	-
150	-	-	-	-	-	SGM7F-1EN
200	-	-	-	-	-	SGM7F-2ZN

Note: The above table shows combinations of the rated torque and outer diameter. The fourth through seventh digits have been omitted.

Specifications and Ratings: Small Capacity

Specifications

Voltage		200 V										
Model SGM7F-		02A	05A	07A	04B	10B	14B	08C	17C	25C	16D	35D
Time Rating		Continuous										
Thermal Class		A										
Insulation Resistance		500 VDC, 10 MΩ min.										
Withstand Voltage		1,500 VAC for 1 minute										
Excitation		Permanent magnet										
Mounting		Flange-mounted										
Drive Method		Direct drive										
Rotation Direction		Counterclockwise (CCW) for forward reference when viewed from the load side										
Vibration Class* ¹		V15										
Absolute Accuracy		±15 s										
Repeatability		±1.3 s										
Protective Structure* ²		Totally enclosed, self-cooled, IP42 (The protective structure is IP40 for CE Marking.)										
Environmental Conditions	Surrounding Air Temperature	0°C to 40°C (with no freezing)										
	Surrounding Air Humidity	20% to 80% relative humidity (with no condensation)										
	Installation Site	<ul style="list-style-type: none"> • Must be indoors and free of corrosive and explosive gases. • Must be well-ventilated and free of dust and moisture. • Must facilitate inspection and cleaning. • Must have an altitude of 1,000 m or less. • Must be free of strong magnetic fields. 										
	Storage Environment	Store the Servomotor in the following environment if you store it with the power cable disconnected. Storage Temperature: -20°C to 60°C (with no freezing) Storage Humidity: 20% to 80% relative humidity (with no condensation)										
Mechanical Tolerances* ³	Runout of Output Shaft Surface	mm	0.02 (0.01 for high machine precision option)									
	Runout at End of Output Shaft	mm	0.04 (0.01 for high machine precision option)									
	Parallelism between Mounting Surface and Output Shaft Surface	mm	0.07									
	Concentricity between Output Shaft and Flange Outer Diameter	mm	0.07									
Shock Resistance* ⁴	Impact Acceleration Rate at Flange	490 m/s ²										
	Number of Impacts	2 times										
Vibration Resistance* ⁴	Vibration Acceleration Rate at Flange	49 m/s ²										
Applicable SERVOPACKs		SGD7S-	2R8A, 2R1F	2R8A, 2R8F		5R5A	2R8A, 2R8F	5R5A	7R6A	5R5A	7R6A* ⁵ , 120A	
		SGD7W-SGD7C-	2R8A				2R8A				7R6A* ⁵	

- *1. A vibration class of V15 indicates a vibration amplitude of 15 μm maximum on the Servomotor without a load at the rated motor speed.
 *2. The hollow hole section, motor mounting surface, output shaft surface, and gap around the rotating part of the shaft are excluded. Protective structure specifications apply only when the special cable is used.
 *3. Refer to the following figure for the relevant locations on the Servomotor. Refer to the dimensional drawings of the individual Servomotors for more information on tolerances.

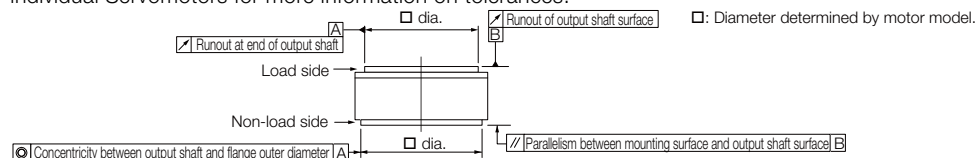

- *4. The given values are for when the Servomotor shaft is mounted horizontally and shock or vibration is applied in the directions shown in the following figures. The strength of the vibration that the Servomotor can withstand depends on the application. Check the vibration acceleration rate.

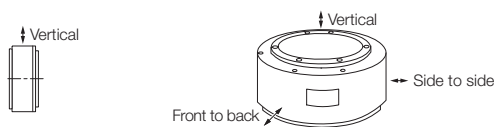

Shock Applied to the Servomotor

Vibration Applied to the Servomotor

- *5. Use derated values for this combination. Refer to the following section for information on derating values.

Ratings (page 162)

Ratings

Voltage		200 V										
Model SGM7F-		02A	05A	07A	04B	10B	14B	08C	17C	25C	16D	35D
Rated Output* ¹	W	63	157	220	126	314	440	251	534	785	503	1100 1000 * ⁵
Rated Torque* ^{1, *2}	N·m	2.00	5.00	7.00	4.00	10.0	14.0	8.00	17.0	25.0	16.0	35.0
Instantaneous Maximum Torque* ¹	N·m	6.00	15.0	21.0	12.0	30.0	42.0	24.0	51.0	75.0	48.0	105
Stall Torque* ¹	N·m	2.00	5.00	7.00	4.00	10.0	14.0	8.00	17.0	25.0	16.0	35.0
Rated Current* ¹	Arms	1.7	1.8	2.1	2.0	2.8	4.6	2.4	4.5		5.0	
Instantaneous Maximum Current* ¹	Arms	5.1	5.4	6.3	6.4	8.9	14.1	8.6	14.7	13.9	16.9	16.0
Rated Motor Speed* ¹	min ⁻¹	300			300			300				300 270* ⁵
Maximum Motor Speed* ¹	min ⁻¹	600			600			600	500	600	400	
Torque Constant	N·m/Arms	1.28	3.01	3.64	2.21	3.81	3.27	3.52	4.04	6.04	3.35	7.33
Motor Moment of Inertia	×10 ⁻⁴ kg·m ²	8.04	14.5	19.3	16.2	25.2	36.9	56.5	78.5	111	178	276
Rated Power Rate* ¹	kW/s	4.98	17.2	25.4	9.88	39.7	53.1	11.3	36.8	56.3	14.4	44.4
Rated Angular Acceleration Rate* ¹	rad/s ²	2490	3450	3630	2470	3970	3790	1420	2170	2250	899	1270
Heat Sink Size	mm	300 × 300 × 12			350 × 350 × 12			450 × 450 × 12			550 × 550 × 12	
Allowable Load Moment of Inertia (Motor Moment of Inertia Ratio)		25 times	35 times	35 times	25 times	40 times	45 times	15 times	25 times	25 times	10 times	15 times
	With External Regenerative Resistor and External Dynamic Brake Resistor* ³	25 times	35 times	35 times	25 times	40 times	45 times	15 times	25 times	25 times	10 times	15 times
Allowable Load* ⁴	Allowable Thrust Load	N	22	24	26	1500			3300			4000
	Allowable Moment Load	N·m	1100	1100	1100	45	55	65	92	98	110	210

*1. These values are for operation in combination with a SERVOPACK when the temperature of the armature winding is 100°C. The values for other items are at 20°C. These are typical values.

*2. The rated torques are the continuous allowable torque values at a surrounding air temperature of 40°C with a steel heat sink of the dimensions given in the table.

*3. To externally connect dynamic brake resistor, select hardware option specification 020 for the SERVOPACK. However, you cannot externally connect dynamic brake resistor if you use the following SERVOPACKs (maximum applicable motor capacity: 400 W).

- SGD7S-R70□□□A020 to -2R8□□□A020
- SGD7W-1R6A20A020 to -2R8A20A020
- SGD7C-1R6AMAA020 to -2R8AMAA020

*4. The thrust loads and moment loads that are applied while a Servomotor is operating are roughly classified into the following patterns. Design the machine so that the thrust loads or moment loads will not exceed the values given in the table.

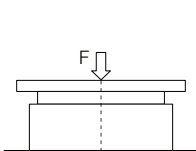

Where F is the external force,
Thrust load = F + Load mass
Moment load = 0

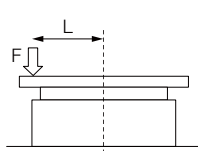

Where F is the external force,
Thrust load = F + Load mass
Moment load = F × L

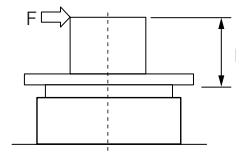

Where F is the external force,
Thrust load = Load mass
Moment load = F × L

*5. If you use an SGD7S-7R6A SERVOPACK and SGM7F-35D Servomotor together, use this value (a derated value).

Note: For the bearings used in these Servomotors, the loss depends on the bearing temperature. The amount of heat loss is higher at low temperatures.

Torque-Motor Speed Characteristics

A : Continuous duty zone ——— (solid lines): With three-phase 200-V or single-phase 230-V input
B : Intermittent duty zone - - - - - (dotted lines): With single-phase 200-V input
 - · - · - (dashed-dotted lines): With single-phase 100-V input

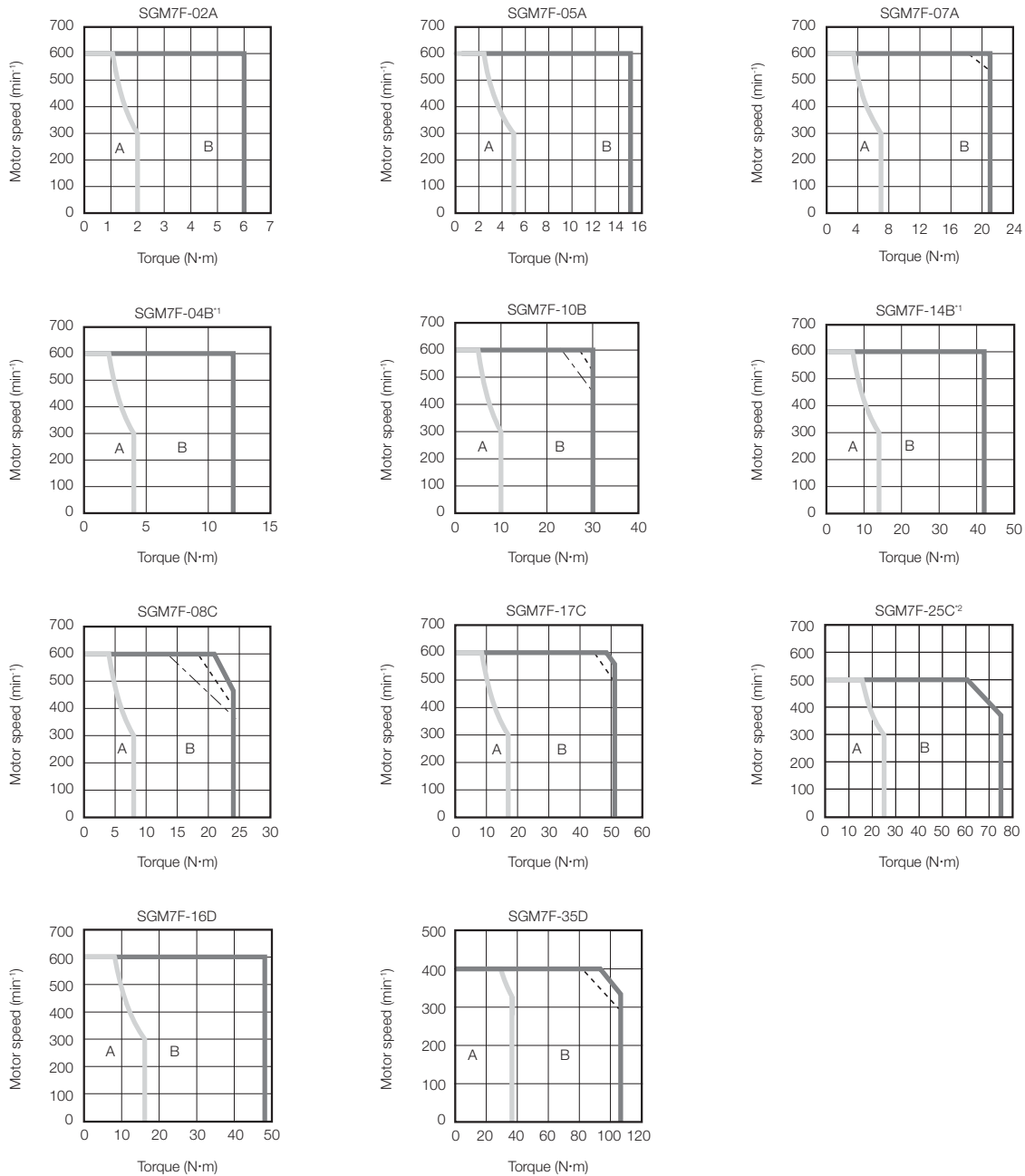

*1. The characteristics are the same for three-phase 200 V, single-phase 200 V, and single-phase 100 V.

*2. Contact your Yaskawa representative for information on the SGM7F-25C.

Note: 1. These values (typical values) are for operation in combination with a SERVOPACK when the temperature of the armature winding is 100°C.

2. The characteristics in the intermittent duty zone depend on the power supply voltage.

3. If you use a Servomotor Main Circuit Cable that exceeds 20 m, the intermittent duty zone in the torque-motor speed characteristics will become smaller because the voltage drop increases.

Servomotor Overload Protection Characteristics

The overload detection level is set for hot start conditions with a Servomotor surrounding air temperature of 40°C.

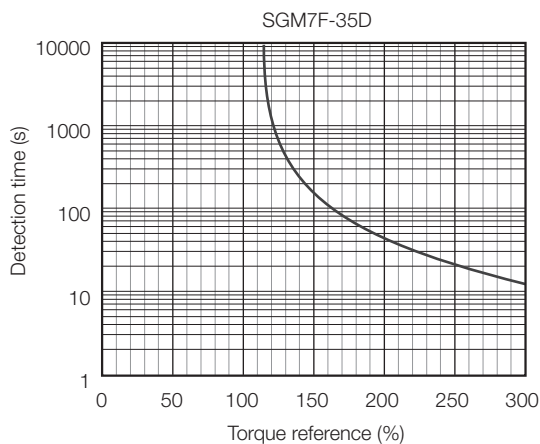
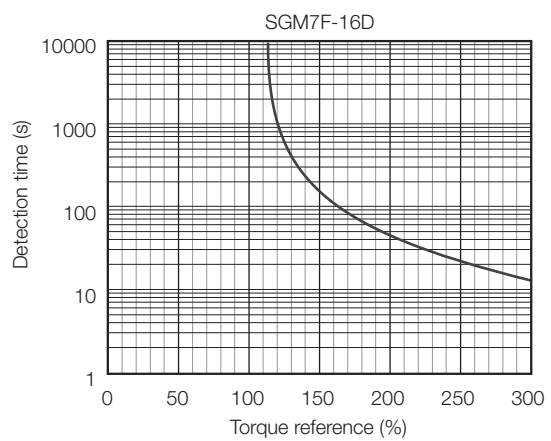
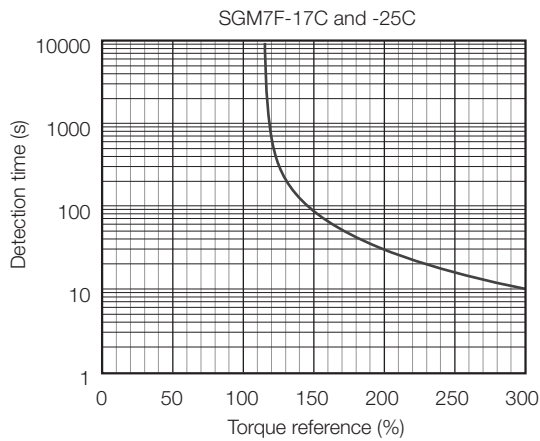
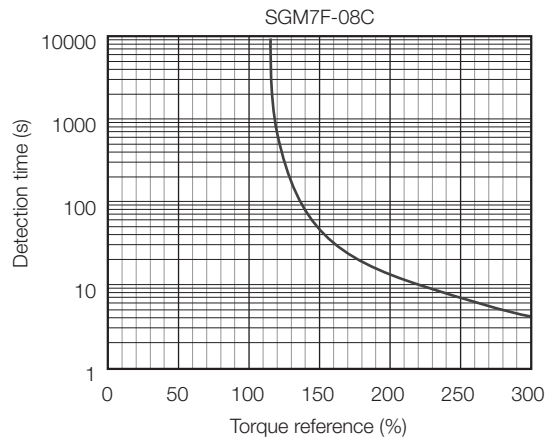
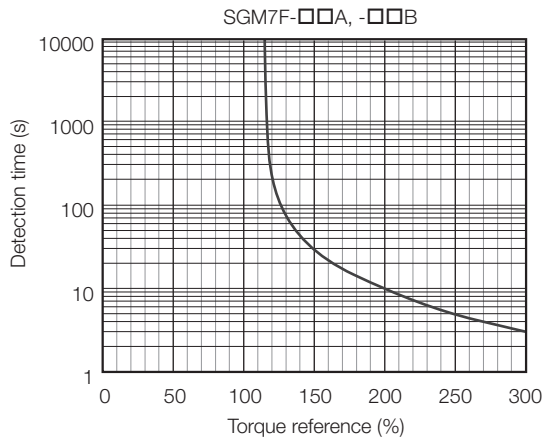

Note: The above overload protection characteristics do not mean that you can perform continuous duty operation with an output of 100% or higher. Use the Servomotor so that the effective torque remains within the continuous duty zone given in *Torque-Motor Speed Characteristics* on page 163.

Allowable Load Moment of Inertia

The allowable load moments of inertia (motor moment of inertia ratios) for the Servomotors are given in the *Ratings* (page 162). The values are determined by the regenerative energy processing capacity of the SERVOPACK and are also affected by the drive conditions of the Servomotor. Perform the required Steps for each of the following cases.

Use the SigmaSize+ AC Servo Drive Capacity Selection Program to check the driving conditions. Contact your Yaskawa representative for information on this program.

◆ Exceeding the Allowable Load Moment of Inertia

Use one of the following measures to adjust the load moment of inertia to within the allowable value.

- Reduce the torque limit.
- Reduce the deceleration rate.
- Reduce the maximum motor speed.

If the above steps is not possible, install an external regenerative resistor.

Information

An Overvoltage Alarm (A.400) is likely to occur during deceleration if the load moment of inertia exceeds the allowable load moment of inertia. SERVOPACKs with a built-in regenerative resistor may generate a Regenerative Overload Alarm (A.320). Refer to *Built-In Regenerative Resistor* (page 472) for the regenerative power (W) that can be processed by the SERVOPACKs.

Install an External Regenerative Resistor when the built-in regenerative resistor cannot process all of the regenerative power.

◆ SERVOPACKs without Built-in Regenerative Resistors

The following graph shows the allowable load moment of inertia scaling factor of the motor speed (reference values for deceleration operation at or above the rated torque). Application is possible without an external regenerative resistor within the allowable value. However, an External Regenerative Resistor is required in the shaded areas of the graphs.

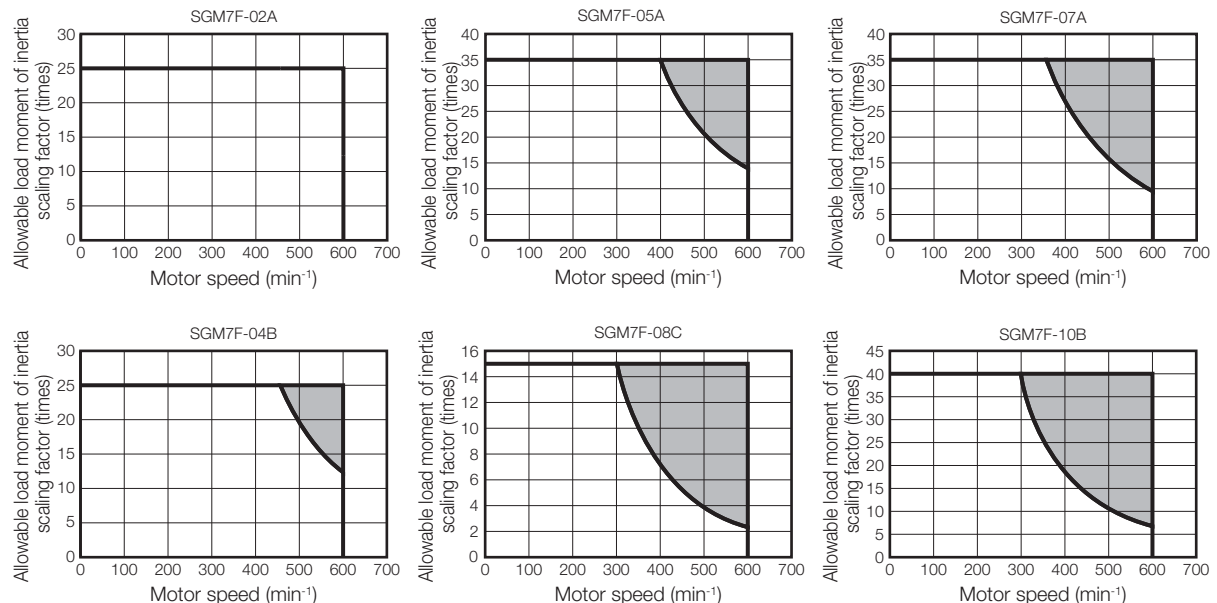

Note: Applicable SERVOPACK models: SGD7S-2R8A and -2R8F

◆ When an External Regenerative Resistor Is Required

Install the External Regenerative Resistor. Refer to the following section for the recommended products.

[External Regenerative Resistors](#) (page 472)

Specifications and Ratings: Medium Capacity

Specifications

Voltage		200 V					
Model SGM7F-		45M	80M	1AM	80N	1EN	2ZN
Time Rating		Continuous					
Thermal Class		F					
Insulation Resistance		500 VDC, 10 MΩ min.					
Withstand Voltage		1,500 VAC for 1 minute					
Excitation		Permanent magnet					
Mounting		Flange-mounted					
Drive Method		Direct drive					
Rotation Direction		Counterclockwise (CCW) for forward reference when viewed from the load side					
Vibration Class*1		V15					
Absolute Accuracy		±15 s					
Repeatability		±1.3 s					
Protective Structure*2		Totally enclosed, self-cooled, IP44					
Environmental Conditions	Surrounding Air Temperature		0°C to 40°C (with no freezing)				
	Surrounding Air Humidity		20% to 80% relative humidity (with no condensation)				
	Installation Site		<ul style="list-style-type: none"> • Must be indoors and free of corrosive and explosive gases. • Must be well-ventilated and free of dust and moisture. • Must facilitate inspection and cleaning. • Must have an altitude of 1,000 m or less. • Must be free of strong magnetic fields. 				
	Storage Environment		Store the Servomotor in the following environment if you store it with the power cable disconnected. Storage Temperature: -20°C to 60°C (with no freezing) Storage Humidity: 20% to 80% relative humidity (with no condensation)				
Mechanical Tolerances*3	Runout of Output Shaft Surface	mm	0.02 (0.01 for high machine precision option)				
	Runout at End of Output Shaft	mm	0.04 (0.01 for high machine precision option)				
	Parallelism between Mounting Surface and Output Shaft Surface	mm	-				
	Concentricity between Output Shaft and Flange Outer Diameter	mm	0.08				
	Perpendicularity between Mounting Surface and Output Shaft	mm	0.08				
Shock Resistance*4	Impact Acceleration Rate at Flange	490 m/s ²					
	Number of Impacts	2 times					
Vibration Resistance*4	Vibration Acceleration Rate at Flange	24.5 m/s ²					
Applicable SERVOPACKs	SGD7S-	7R6A	120A	180A	120A	200 A	
	SGD7W- SGD7C-	7R6A	-				

*1. A vibration class of V15 indicates a vibration amplitude of 15 μm maximum on the Servomotor without a load at the rated motor speed.

*2. This does not apply to the shaft opening. Protective structure specifications apply only when the special cable is used.

*3. Refer to the following figure for the relevant locations on the Servomotor. Refer to the dimensional drawings of the individual Servomotors for more information on tolerances.

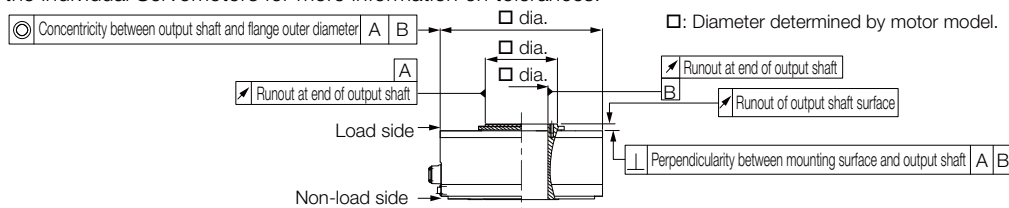

*4. The given values are for when the Servomotor shaft is mounted horizontally and shock or vibration is applied in the directions shown in the following figures.

The strength of the vibration that the Servomotor can withstand depends on the application. Check the vibration acceleration rate.

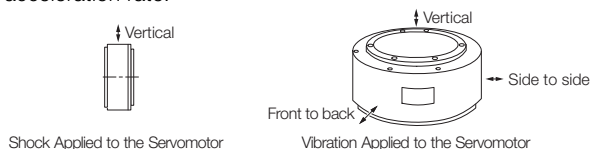

Ratings

Voltage		200 V					
Model SGM7F-		45M	80M	1AM	80N	1EN	2ZN
Rated Output* ¹	W	707	1260	1730	1260	2360	3140
Rated Torque* ^{1, *2}	N·m	45.0	80.0	110	80.0	150	200
Instantaneous Maximum Torque* ¹	N·m	135	240	330	240	450	600
Stall Torque* ¹	N·m	45.0	80.0	110	80.0	150	200
Rated Current* ¹	Arms	5.8	9.7	13.4	9.4	17.4	18.9
Instantaneous Maximum Current* ¹	Arms	17.0	28.0	42.0	28.0	56.0	56.0
Rated Motor Speed* ¹	min ⁻¹	150			150		
Maximum Motor Speed* ¹	min ⁻¹	300			300	250	
Torque Constant	N·m/Arms	8.39	8.91	8.45	9.08	9.05	11.5
Motor Moment of Inertia	×10 ⁻⁴ kg·m ²	388	627	865	1360	2470	3060
Rated Power Rate* ¹	kW/s	52.2	102	140	47.1	91.1	131
Rated Angular Acceleration Rate* ¹	rad/s ²	1160	1280	1270	588	607	654
Heat Sink Size	mm	750 × 750 × 45					
Allowable Load Moment of Inertia (Motor Moment of Inertia Ratio)		3 times					
With External Regenerative Resistor and External Dynamic Brake Resistor		3 times					
Allowable Load* ³	A	mm	33			37.5	
	Allowable Thrust Load	N	9000			16000	
	Allowable Moment Load	N·m	180			350	

*1. These values are for operation in combination with a SERVOPACK when the temperature of the armature winding is 20°C. These are typical values.

*2. The rated torques are the continuous allowable torque values at a surrounding air temperature of 40°C with a steel heat sink of the dimensions given in the table.

*3. The thrust loads and moment loads that are applied while a Servomotor is operating are roughly classified into the following patterns. Design the machine so that the thrust loads or moment loads will not exceed the values given in the table.

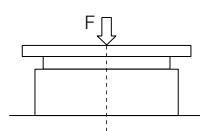

Where F is the external force,
Thrust load = F + Load mass
Moment load = 0

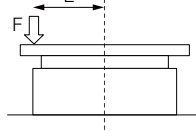

Where F is the external force,
Thrust load = F + Load mass
Moment load = F × L

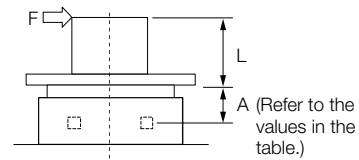

Where F is the external force,
Thrust load = Load mass
Moment load = F × (L + A)

Note: For the bearings used in these Servomotors, the loss depends on the bearing temperature. The amount of heat loss is higher at low temperatures.

Torque-Motor Speed Characteristics

▭ A : Continuous duty zone

▭ B : Intermittent duty zone

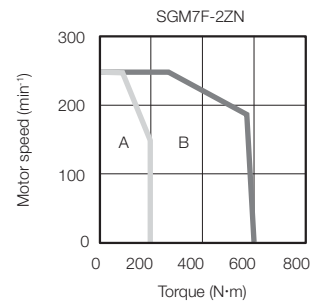
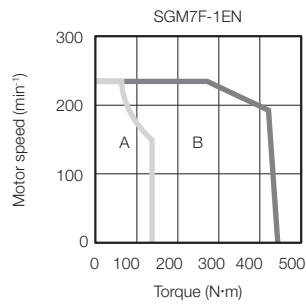
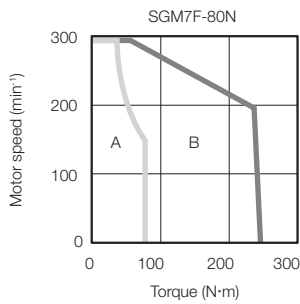
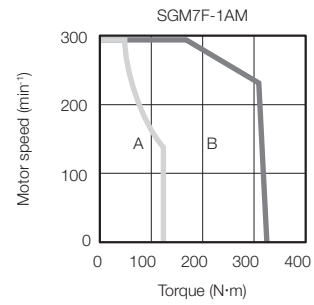
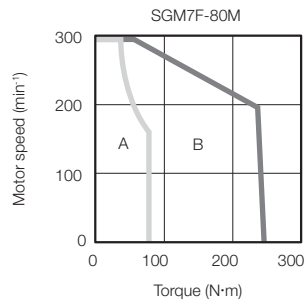
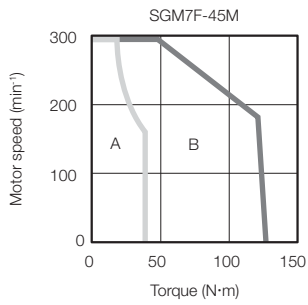

- Note: 1. These values (typical values) are for operation in combination with a SERVOPACK when the temperature of the armature winding is 20°C.
2. If the effective torque is within the allowable range for the rated torque, the Servomotor can be used within the intermittent duty zone.
3. If you use a Servomotor Main Circuit Cable that exceeds 20 m, the intermittent duty zone in the torque-motor speed characteristics will become smaller because the voltage drop increases.

Servomotor Overload Protection Characteristics

The overload detection level is set for hot start conditions with a Servomotor surrounding air temperature of 40°C.

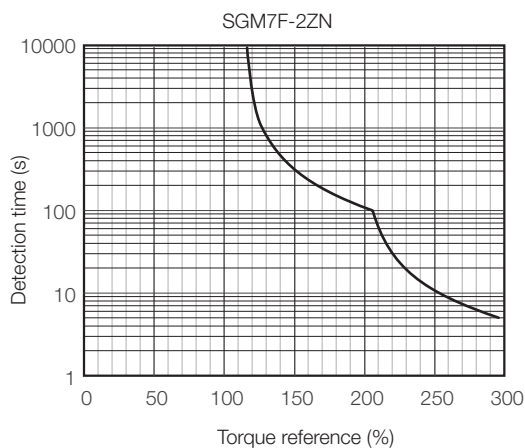
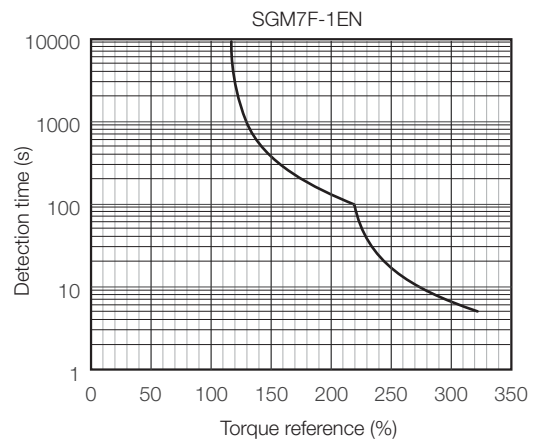
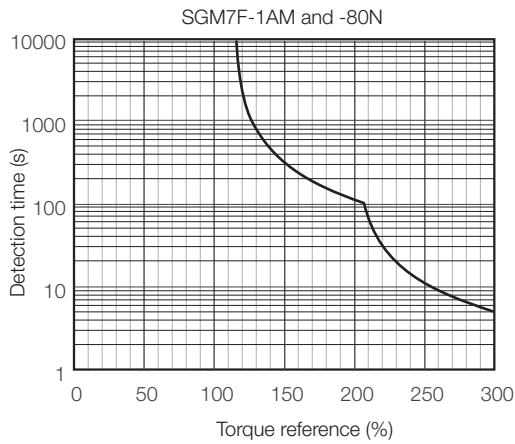
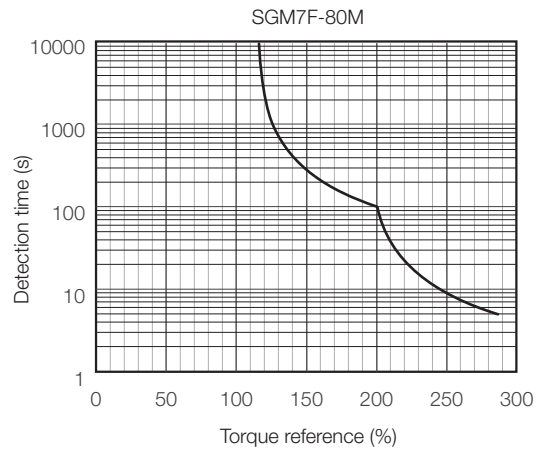
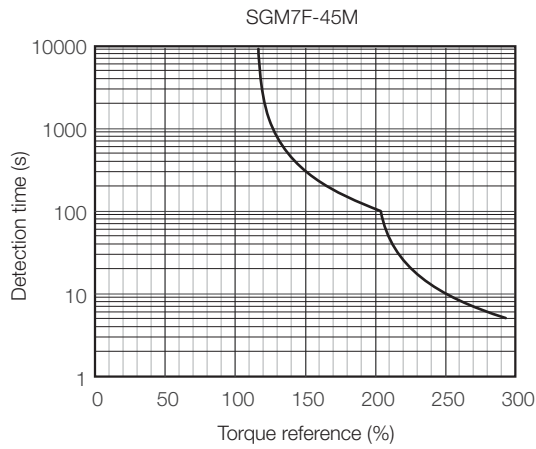

Note: The above overload protection characteristics do not mean that you can perform continuous duty operation with an output of 100% or higher. Use the Servomotor so that the effective torque remains within the continuous duty zone given in *Torque-Motor Speed Characteristics* on page 168.

Allowable Load Moment of Inertia

The allowable load moments of inertia (motor moment of inertia ratios) for the Servomotors are given in the *Ratings* (page 167). The values are determined by the regenerative energy processing capacity of the SERVOPACK and are also affected by the drive conditions of the Servomotor. Perform the required Steps for each of the following cases.

Use the SigmaSize+ AC Servo Drive Capacity Selection Program to check the driving conditions. Contact your Yaskawa representative for information on this program.

◆ Exceeding the Allowable Load Moment of Inertia

Use one of the following measures to adjust the load moment of inertia to within the allowable value.

- Reduce the torque limit.
- Reduce the deceleration rate.
- Reduce the maximum motor speed.

If the above steps is not possible, install an external regenerative resistor.

Information An Overvoltage Alarm (A.400) is likely to occur during deceleration if the load moment of inertia exceeds the allowable load moment of inertia. SERVOPACKs with a built-in regenerative resistor may generate a Regenerative Overload Alarm (A.320). Refer to *Built-In Regenerative Resistor* (page 472) for the regenerative power (W) that can be processed by the SERVOPACKs.

Install an External Regenerative Resistor when the built-in regenerative resistor cannot process all of the regenerative power.

◆ When an External Regenerative Resistor Is Required

Install the External Regenerative Resistor. Refer to the following section for the recommended products.

 *External Regenerative Resistors* (page 472)

External Dimensions

◆ SGM7F-□□A

• Flange Specification 1

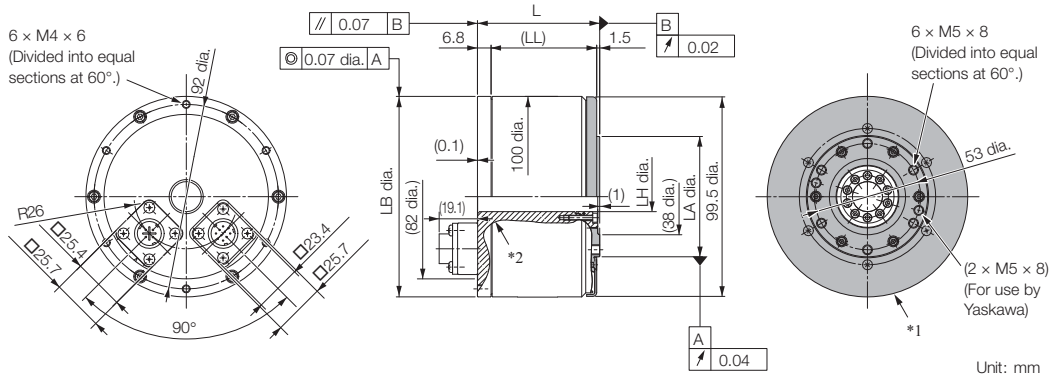

*1. The shaded section indicates the rotating parts.

*2. The hatched section indicates the non-rotating parts.

Note: Values in parentheses are reference dimensions.

Model SGM7F-	L	(LL)	LB	LH	LA	Approx. Mass [kg]
02A□A11	61	(52.7)	100 ⁰ _{-0.035}	15 ^{+0.4} ₀	60 ⁰ _{-0.030}	2.5
05A□A11	96	(87.7)	100 ⁰ _{-0.035}	15 ^{+0.4} ₀	60 ⁰ _{-0.030}	5.0
07A□A11	122	(113.7)	100 ⁰ _{-0.035}	15 ^{+0.4} ₀	60 ⁰ _{-0.030}	6.5

• Flange Specification 4

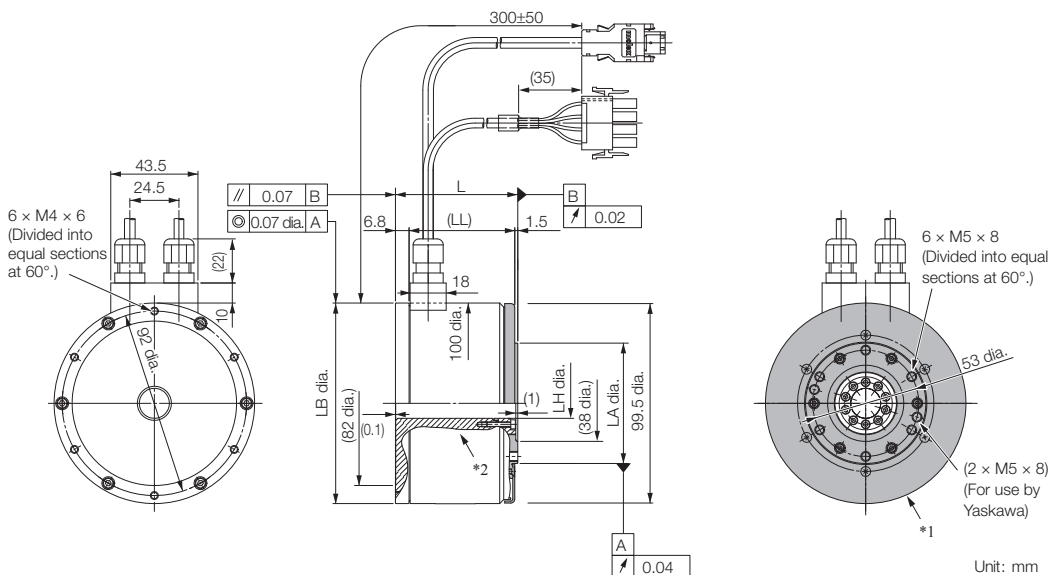

*1. The shaded section indicates the rotating parts.

*2. The hatched section indicates the non-rotating parts.

Note: Values in parentheses are reference dimensions.

Model SGM7F-	L	(LL)	LB	LH	LA	Approx. Mass [kg]
02A□A41	61	(52.7)	100 ⁰ _{-0.035}	15 ^{+0.4} ₀	60 ⁰ _{-0.030}	2.5
05A□A41	96	(87.7)	100 ⁰ _{-0.035}	15 ^{+0.4} ₀	60 ⁰ _{-0.030}	5.0
07A□A41	122	(113.7)	100 ⁰ _{-0.035}	15 ^{+0.4} ₀	60 ⁰ _{-0.030}	6.5

Refer to the following section for information on connectors.

☞ Connector Specifications (page 177)

◆ SGM7F-□□B

• Flange Specification 1

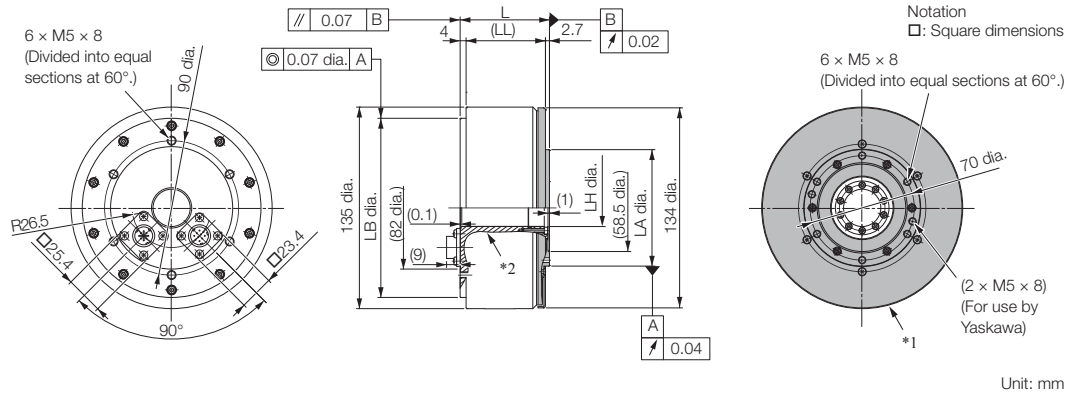

- *1. The shaded section indicates the rotating parts.
 - *2. The hatched section indicates the non-rotating parts.
- Note: Values in parentheses are reference dimensions.

Model SGM7F-	L	(LL)	LB	LH	LA	Approx. Mass [kg]
04B□A11	60	53.3	120 ⁰ _{-0.035}	25 ^{+0.3} _{+0.1}	78 ⁰ _{-0.030}	5.0
10B□A11	85	78.3	120 ⁰ _{-0.035}	25 ^{+0.3} _{+0.1}	78 ⁰ _{-0.030}	6.5
14B□A11	115	108.3	120 ⁰ _{-0.035}	25 ^{+0.3} _{+0.1}	78 ⁰ _{-0.030}	9.0

• Flange Specification 4

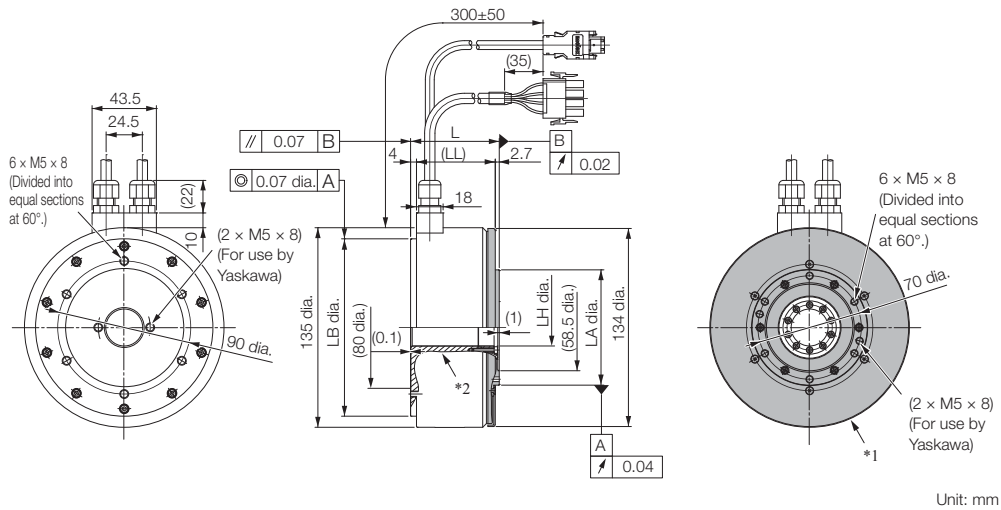

- *1. The shaded section indicates the rotating parts.
 - *2. The hatched section indicates the non-rotating parts.
- Note: Values in parentheses are reference dimensions.

Model SGM7F-	L	(LL)	LB	LH	LA	Approx. Mass [kg]
04B□A41	60	53.3	120 ⁰ _{-0.035}	25 ^{+0.3} _{+0.1}	78 ⁰ _{-0.030}	5.0
10B□A41	85	78.3	120 ⁰ _{-0.035}	25 ^{+0.3} _{+0.1}	78 ⁰ _{-0.030}	6.5
14B□A41	115	108.3	120 ⁰ _{-0.035}	25 ^{+0.3} _{+0.1}	78 ⁰ _{-0.030}	9.0

Refer to the following section for information on connectors.

🔌 Connector Specifications (page 177)

◆ SGM7F-□□C

• Flange Specification 1

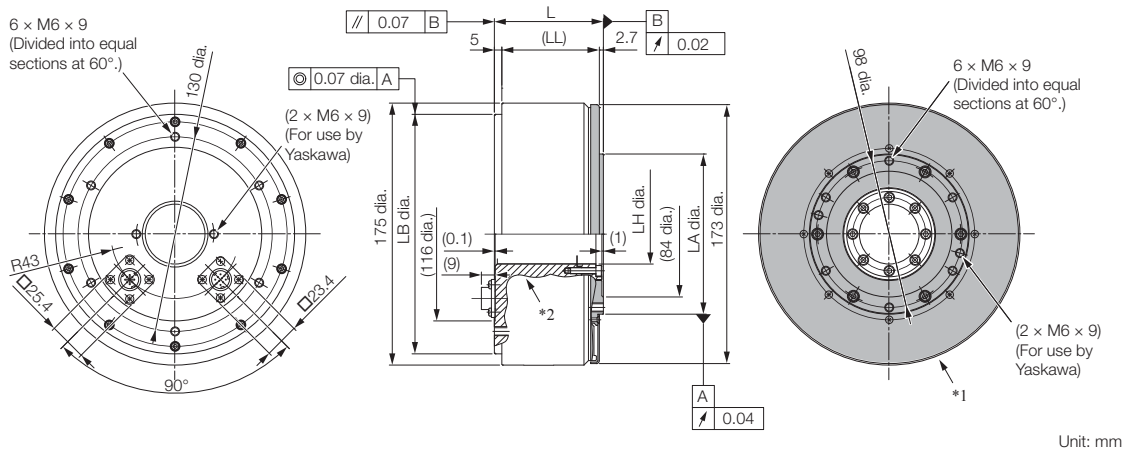

- *1. The shaded section indicates the rotating parts.
 - *2. The hatched section indicates the non-rotating parts.
- Note: Values in parentheses are reference dimensions.

Model SGM7F-	L	(LL)	LB	LH	LA	Approx. Mass [kg]
08C□A11	73	65.3	160 ⁰ _{-0.040}	40 ^{+0.3} _{+0.1}	107 ⁰ _{-0.035}	9.0
17C□A11	87	79.3	160 ⁰ _{-0.040}	40 ^{+0.3} _{+0.1}	107 ⁰ _{-0.035}	11.0
25C□A11	117	109.3	160 ⁰ _{-0.040}	40 ^{+0.3} _{+0.1}	107 ⁰ _{-0.035}	15.0

• Flange Specification 4

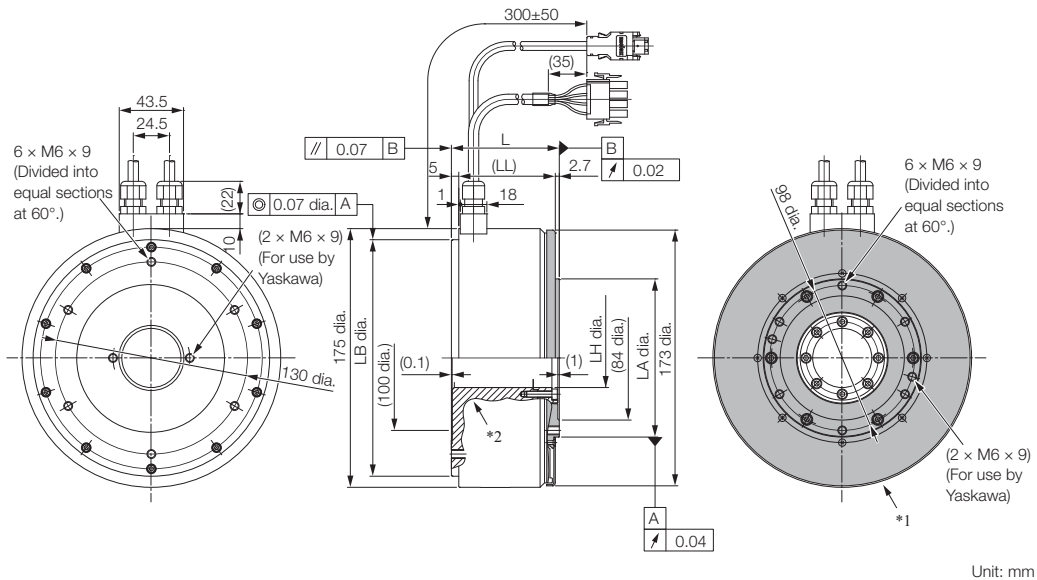

- *1. The shaded section indicates the rotating parts.
 - *2. The hatched section indicates the non-rotating parts.
- Note: Values in parentheses are reference dimensions.

Model SGM7F-	L	(LL)	LB	LH	LA	Approx. Mass [kg]
08C□A41	73	65.3	160 ⁰ _{-0.040}	40 ^{+0.3} _{+0.1}	107 ⁰ _{-0.035}	9.0
17C□A41	87	79.3	160 ⁰ _{-0.040}	40 ^{+0.3} _{+0.1}	107 ⁰ _{-0.035}	11.0
25C□A41	117	109.3	160 ⁰ _{-0.040}	40 ^{+0.3} _{+0.1}	107 ⁰ _{-0.035}	15.0

Refer to the following section for information on connectors.

☞ Connector Specifications (page 177)

◆ SGM7F-□□□D

• Flange Specification 1

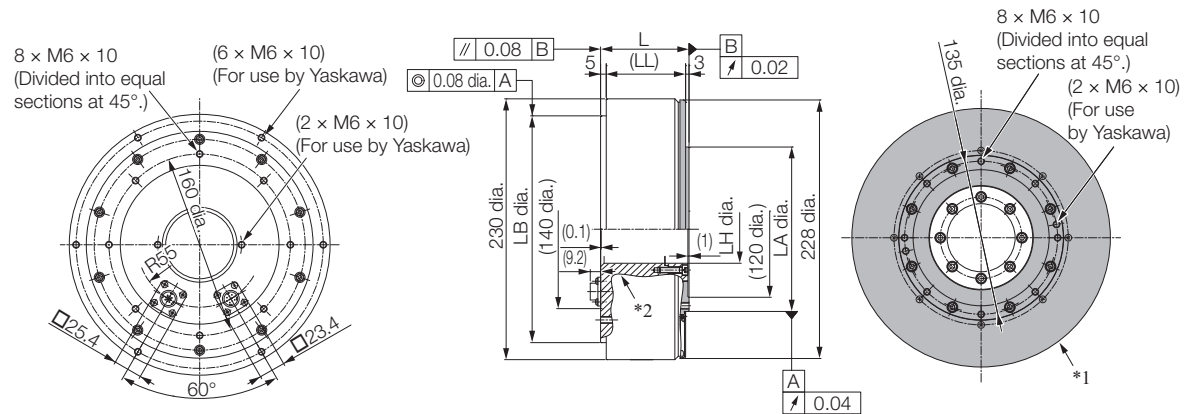

Unit: mm

*1. The shaded section indicates the rotating parts.

*2. The hatched section indicates the non-rotating parts.

Note: Values in parentheses are reference dimensions.

Model SGM7F-	L	(LL)	LB	LH	LA	Approx. Mass [kg]
16D□A11	78	70	200 ⁰ _{-0.046}	60 ^{+0.4} ₀	145 ⁰ _{-0.040}	16.0
35D□A11	107	99	200 ⁰ _{-0.046}	60 ^{+0.4} ₀	145 ⁰ _{-0.040}	25.0

• Flange Specification 4

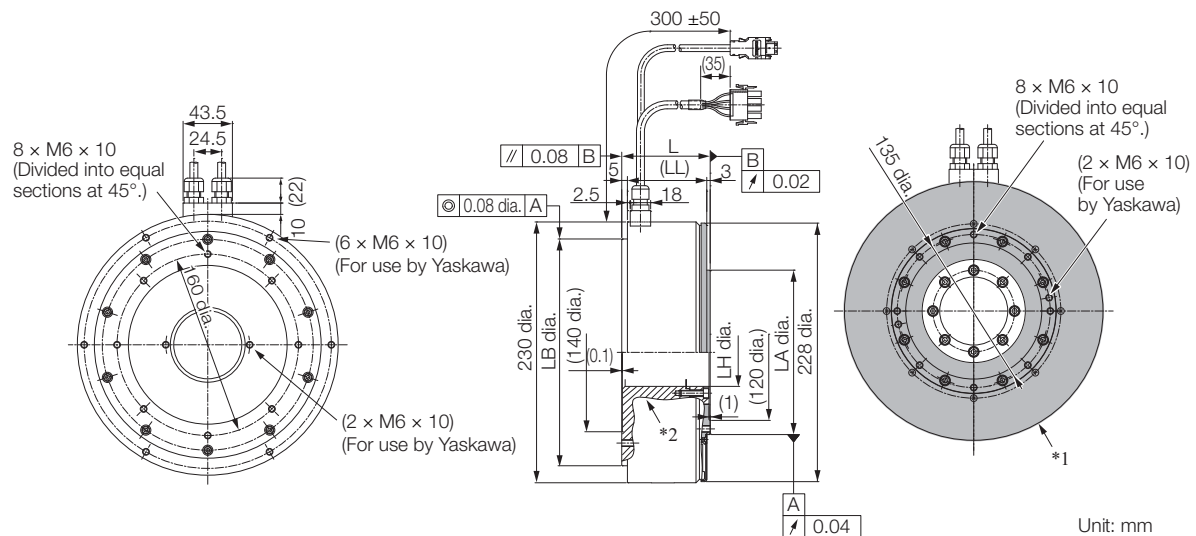

Unit: mm

*1. The shaded section indicates the rotating parts.

*2. The hatched section indicates the non-rotating parts.

Note: Values in parentheses are reference dimensions.

Model SGM7F-	L	(LL)	LB	LH	LA	Approx. Mass [kg]
16D□A41	78	70	200 ⁰ _{-0.046}	60 ^{+0.4} ₀	145 ⁰ _{-0.040}	16.0
35D□A41	107	99	200 ⁰ _{-0.046}	60 ^{+0.4} ₀	145 ⁰ _{-0.040}	25.0

Refer to the following section for information on connectors.

☞ Connector Specifications (page 177)

◆ SGM7F-□□M

• Flange Specification 1

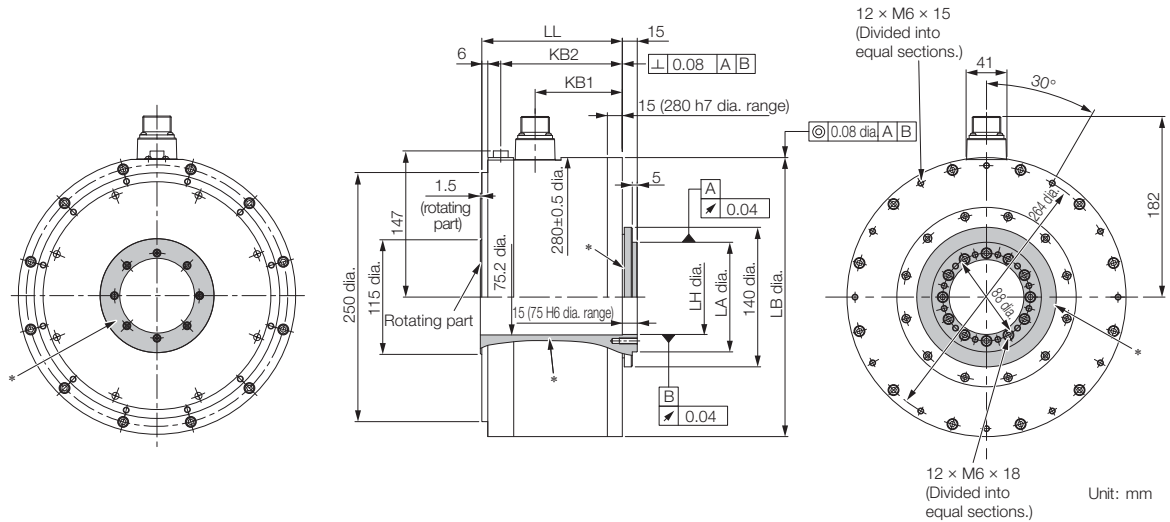

* The shaded section indicates the rotating parts.

Model SGM7F-	LL	KB1	KB2	LB	LH	LA	Approx. Mass [kg]
45M□A11	141	87.5	122	280 ⁰ _{-0.052}	75 ^{+0.019} ₀	110 ⁰ _{-0.035}	38
80M□A11	191	137.5	172	280 ⁰ _{-0.052}	75 ^{+0.019} ₀	110 ⁰ _{-0.035}	45
1AM□A11	241	187.5	222	280 ⁰ _{-0.052}	75 ^{+0.019} ₀	110 ⁰ _{-0.035}	51

• Flange Specification 3

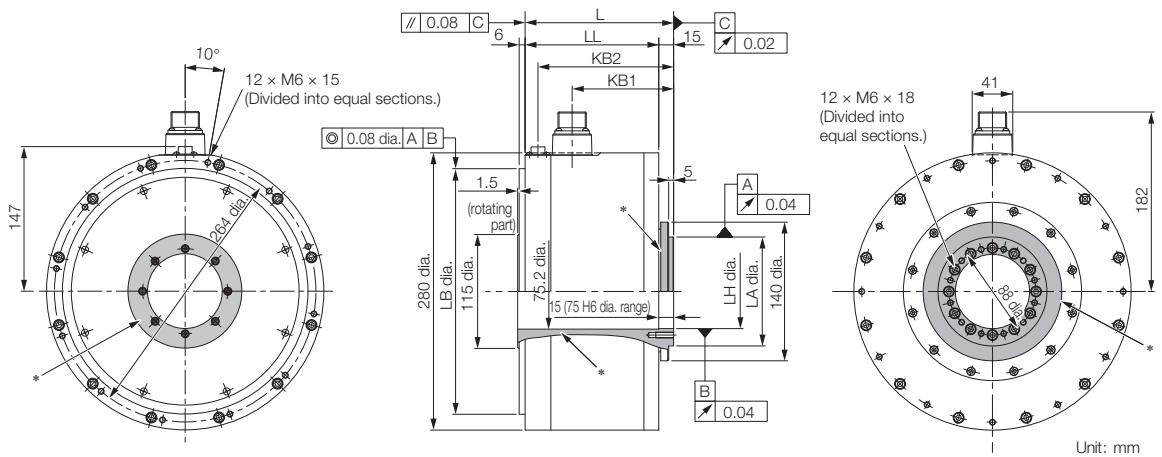

* The shaded section indicates the rotating parts.

Model SGM7F-	L	LL	KB1	KB2	LB	LH	LA	Approx. Mass [kg]
45M□A31	150	135	102.5	137	248 ⁰ _{-0.046}	75 ^{+0.019} ₀	110 ⁰ _{-0.035}	38
80M□A31	200	185	152.5	187	248 ⁰ _{-0.046}	75 ^{+0.019} ₀	110 ⁰ _{-0.035}	45
1AM□A31	250	235	202.5	237	248 ⁰ _{-0.046}	75 ^{+0.019} ₀	110 ⁰ _{-0.035}	51

Refer to the following section for information on connectors.

☞ Connector Specifications (page 177)

◆ SGM7F-□□N

• Flange Specification 1

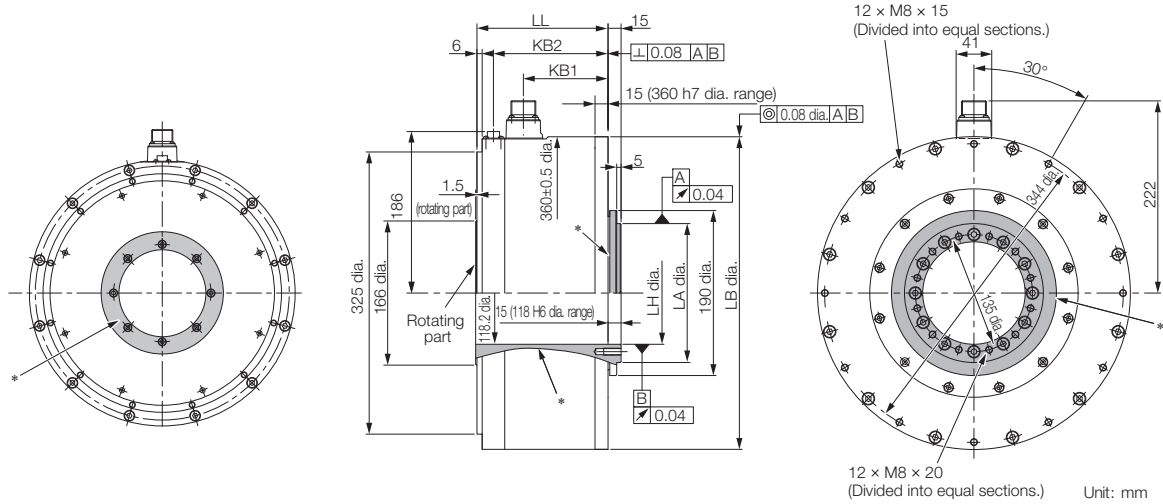

* The shaded section indicates the rotating parts.

Model SGM7F-	LL	KB1	KB2	LB	LH	LA	Approx. Mass [kg]
80N□A11	151	98	132	360 ⁰ _{-0.057}	118 ^{+0.022} ₀	160 ⁰ _{-0.040}	50
1EN□A11	201	148	182	360 ⁰ _{-0.057}	118 ^{+0.022} ₀	160 ⁰ _{-0.040}	68
2ZN□A11	251	198	232	360 ⁰ _{-0.057}	118 ^{+0.022} ₀	160 ⁰ _{-0.040}	86

• Flange Specification 3

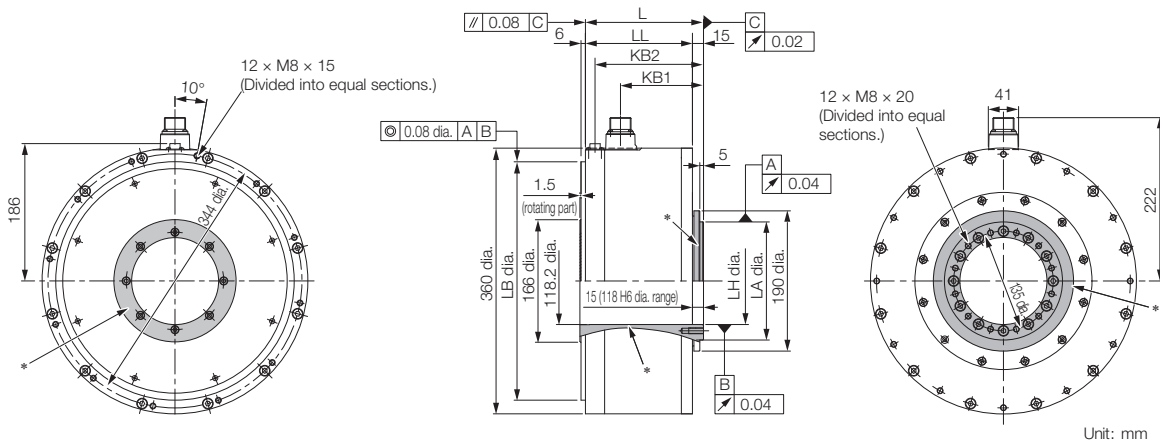

* The shaded section indicates the rotating parts.

Model SGM7F-	L	LL	KB1	KB2	LB	LH	LA	Approx. Mass [kg]
80N□A31	160	145	113	147	323 ⁰ _{-0.057}	118 ^{+0.022} ₀	160 ⁰ _{-0.040}	50
1EN□A31	210	195	163	197	323 ⁰ _{-0.057}	118 ^{+0.022} ₀	160 ⁰ _{-0.040}	68
2ZN□A31	260	245	213	247	323 ⁰ _{-0.057}	118 ^{+0.022} ₀	160 ⁰ _{-0.040}	86

Refer to the following section for information on connectors.

🔗 Connector Specifications (page 177)

Connector Specifications

◆ SGM7F-□□A, -□□B, -□□C, or -□□D: Flange Specification 1

• Servomotor Connector

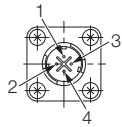

1	Phase U
2	Phase V
3	Phase W
4	FG (frame ground)

Model: JN1AS04MK2R
Manufacturer: Japan Aviation Electronics Industry, Ltd.

Mating connector: JN1DS04FK1
(Not provided by Yaskawa.)

• Encoder Connector

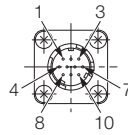

1	PS
2	/PS
3	-
4	PG5V
5*	BAT0
6	-
7	FG (frame ground)
8*	BAT
9	PG0V
10	-

* Only absolute-value models with multiturn data.

Model: JN1AS10ML1-R
Manufacturer: Japan Aviation Electronics Industry, Ltd.

Mating connector: JN1DS10SL1
(Not provided by Yaskawa.)

◆ SGM7F-□□A, -□□B, -□□C, or -□□D: Flange Specification 4

• Servomotor Connector

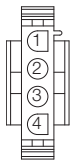

1	Phase U	Red
2	Phase V	White
3	Phase W	Blue
4	FG (frame ground)	Green (yellow)

Models

- Plug: 350779-1
- Pins: 350561-3 or 350690-3 (No.1 to 3)
- Ground pin: 350654-1 or 350669-1 (No. 4)
- Manufacturer: Tyco Electronics Japan G.K.

Mating Connector

- Cap: 350780-1
- Socket: 350570-3 or 350689-3

• Encoder Connector

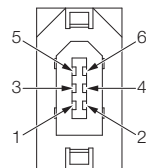

1	PG5V
2	PG0V
3*	BAT
4*	BAT0
5	PS
6	/PS
Connector case	FG (frame ground)

* Only absolute-value models with multiturn data.

Model: 55102-0600
Manufacturer: Molex Japan LLC

Mating connector: 54280-0609

◆ SGM7F-□□M or -□□N with Flange Specification 1 or 3

• Servomotor Connector

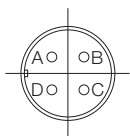

A	Phase U
B	Phase V
C	Phase W
D	FG (frame ground)

Model: CE05-2A18-10PD
Manufacturer: DDK Ltd.

Mating Connector

- Plug: CE05-6A18-10SD-B-BSS
- Cable clamp: CE3057-10A-□(D265)

• Encoder Connector

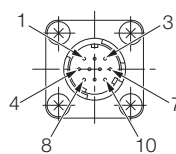

1	PS
2	/PS
3	-
4	PG5V
5*	BAT0
6	-
7	FG (frame ground)
8*	BAT
9	PG0V
10	-

* Only absolute-value models with multiturn data.

Model: JN1AS10ML1
Manufacturer: Japan Aviation Electronics Industry, Ltd.

Mating connector: JN1DS10SL1

Selecting Cables

◆ Cable Configurations

The cables shown below are required to connect a Servomotor to a SERVOPACK.

Encoder Cable of 20 m or Less

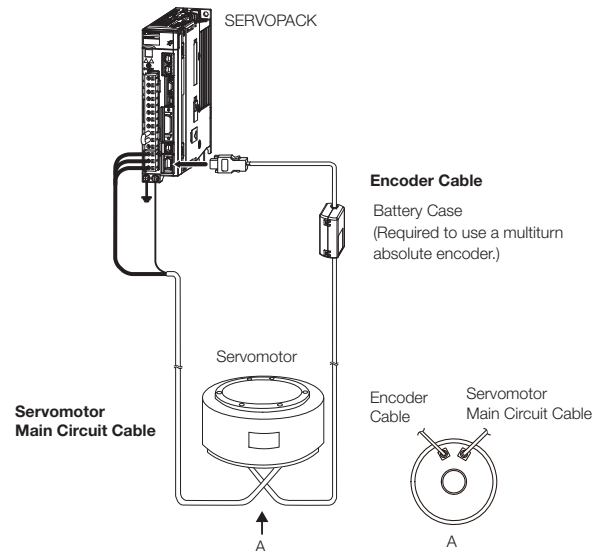

Encoder Cable of 30 m to 50 m (Relay Cable)

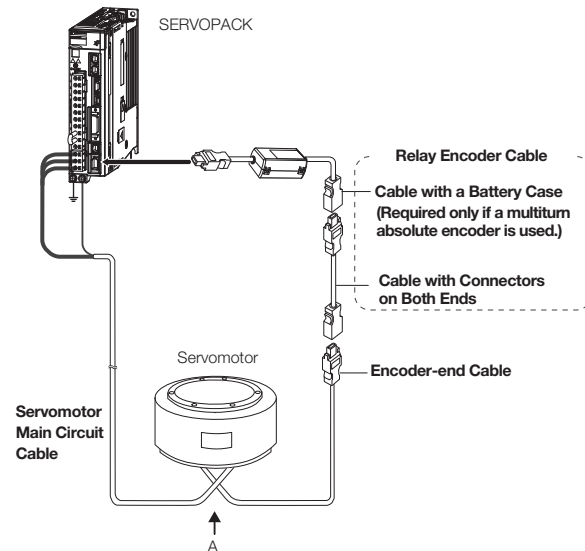

Note: 1. If the Encoder Cable length exceeds 20 m, be sure to use a Relay Encoder Cable.

2. If you use a Servomotor Main Circuit Cable that exceeds 20 m, the intermittent duty zone in the torque-motor speed characteristics will become smaller because the voltage drop increases.

3. Refer to the following manual for the following information.

- Cable dimensional drawings and cable connection specifications
- Order numbers and specifications of individual connectors for cables
- Order numbers and specifications for wiring materials

☞ *Σ-7-Series AC Servo Drive Peripheral Device Selection Manual (Manual No.: SIEP S800001 32)*

◆ Servomotor Main Circuit Cables

Servomotor Model	Length (L)	Order Number		Appearance
		Standard Cable	Flexible Cable*1	
SGM7F-□□A SGM7F-□□B SGM7F-□□C SGM7F-□□D	3 m	JZSP-CMM60-03-E	JZSP-C7MDN23-03-E	
Flange specification*2: 1 Non-load side installation	5 m	JZSP-CMM60-05-E	JZSP-C7MDN23-05-E	
	10 m	JZSP-CMM60-10-E	JZSP-C7MDN23-10-E	
	15 m	JZSP-CMM60-15-E	JZSP-C7MDN23-15-E	
	20 m	JZSP-CMM60-20-E	JZSP-C7MDN23-20-E	
SGM7F-□□A SGM7F-□□B SGM7F-□□C SGM7F-□□D	3 m	JZSP-CMM00-03-E	JZSP-C7MDS23-03-E	
Flange specification*2: 4 Non-load side installation (with cable on side)	5 m	JZSP-CMM00-05-E	JZSP-C7MDS23-05-E	
	10 m	JZSP-CMM00-10-E	JZSP-C7MDS23-10-E	
	15 m	JZSP-CMM00-15-E	JZSP-C7MDS23-15-E	
	20 m	JZSP-CMM00-20-E	JZSP-C7MDS23-20-E	

Continued on next page.

Continued from previous page.

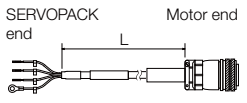
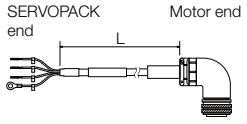
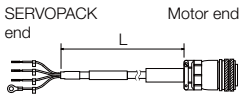
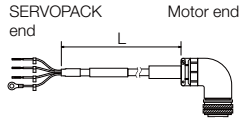
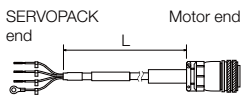
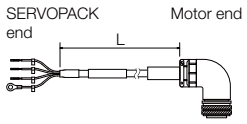
Servomotor Model	Length (L)	Order Number		Appearance	
		Standard Cable	Flexible Cable* ¹		
SGM7F-□□M SGM7F-□□N □□: 45 □□: 80	3 m	JZSP-USA101-03-E	JZSP-USA121-03-E		
	5 m	JZSP-USA101-05-E	JZSP-USA121-05-E		
	10 m	JZSP-USA101-10-E	JZSP-USA121-10-E		
	15 m	JZSP-USA101-15-E	JZSP-USA121-15-E		
	20 m	JZSP-USA101-20-E	JZSP-USA121-20-E		
	3 m	JZSP-USA102-03-E	JZSP-USA122-03-E		
		5 m	JZSP-USA102-05-E		JZSP-USA122-05-E
		10 m	JZSP-USA102-10-E		JZSP-USA122-10-E
		15 m	JZSP-USA102-15-E		JZSP-USA122-15-E
		20 m	JZSP-USA102-20-E		JZSP-USA122-20-E
SGM7F-□□M SGM7F-□□N □□: 1A	3 m	JZSP-USA301-03-E	JZSP-USA321-03-E		
	5 m	JZSP-USA301-05-E	JZSP-USA321-05-E		
	10 m	JZSP-USA301-10-E	JZSP-USA321-10-E		
	15 m	JZSP-USA301-15-E	JZSP-USA321-15-E		
	20 m	JZSP-USA301-20-E	JZSP-USA321-20-E		
	3 m	JZSP-USA302-03-E	JZSP-USA322-03-E		
		5 m	JZSP-USA302-05-E		JZSP-USA322-05-E
		10 m	JZSP-USA302-10-E		JZSP-USA322-10-E
		15 m	JZSP-USA302-15-E		JZSP-USA322-15-E
		20 m	JZSP-USA302-20-E		JZSP-USA322-20-E
SGM7F-□□M SGM7F-□□N □□: 1E □□: 2Z	3 m	JZSP-USA501-03-E	JZSP-USA521-03-E		
	5 m	JZSP-USA501-05-E	JZSP-USA521-05-E		
	10 m	JZSP-USA501-10-E	JZSP-USA521-10-E		
	15 m	JZSP-USA501-15-E	JZSP-USA521-15-E		
	20 m	JZSP-USA501-20-E	JZSP-USA521-20-E		
	3 m	JZSP-USA502-03-E	JZSP-USA522-03-E		
		5 m	JZSP-USA502-05-E		JZSP-USA522-05-E
		10 m	JZSP-USA502-10-E		JZSP-USA522-10-E
		15 m	JZSP-USA502-15-E		JZSP-USA522-15-E
		20 m	JZSP-USA502-20-E		JZSP-USA522-20-E

*1. Use Flexible Cables for moving parts of machines, such as robots. The recommended bending radius of the Flexible Cables are given in the following table.

Order Number	Recommended Bending Radius (R)	Order Number	Recommended Bending Radius (R)
JZSP-C7MDN23-□□-E	90 mm min.	JZSP-USA321-□□-E	113 mm min.
JZSP-C7MDS23-□□-E		JZSP-USA322-□□-E	
JZSP-USA121-□□-E	96 mm min.	JZSP-USA521-□□-E	150 mm min.
JZSP-USA122-□□-E		JZSP-USA522-□□-E	

*2. Refer to the following section for the flange specifications.

 **Model Designations** (page 160)

Note: Direct Drive Servomotors are not available with holding brakes.

◆ Encoder Cables of 20 m or Less

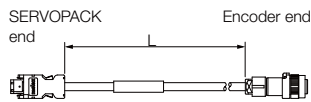
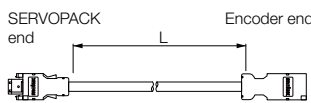
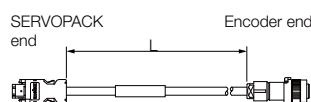
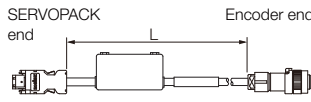
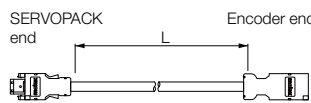
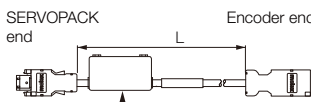
Servomotor Model	Name	Length (L)	Order Number		Appearance
			Standard Cable	Flexible Cable*1	
SGM7F-□□□F Flange specification*2: 1 or 3	For incremental encoder	3 m	JZSP-CMP60-03-E	JZSP-CSP60-03-E	
		5 m	JZSP-CMP60-05-E	JZSP-CSP60-05-E	
		10 m	JZSP-CMP60-10-E	JZSP-CSP60-10-E	
		15 m	JZSP-CMP60-15-E	JZSP-CSP60-15-E	
		20 m	JZSP-CMP60-20-E	JZSP-CSP60-20-E	
SGM7F-□□AF SGM7F-□□BF SGM7F-□□CF SGM7F-□□DF Flange specification*2: 4	For incremental encoder	3 m	JZSP-CMP00-03-E	JZSP-CMP10-03-E	
		5 m	JZSP-CMP00-05-E	JZSP-CMP10-05-E	
		10 m	JZSP-CMP00-10-E	JZSP-CMP10-10-E	
		15 m	JZSP-CMP00-15-E	JZSP-CMP10-15-E	
		20 m	JZSP-CMP00-20-E	JZSP-CMP10-20-E	
SGM7F-□□□7 Flange specification*2: 1 or 3	For multi-turn absolute encoder (without Battery Case*3)	3 m	JZSP-C7PI00-03-E	JZSP-C7PI20-03-E	
		5 m	JZSP-C7PI00-05-E	JZSP-C7PI20-05-E	
		10 m	JZSP-C7PI00-10-E	JZSP-C7PI20-10-E	
		15 m	JZSP-C7PI00-15-E	JZSP-C7PI20-15-E	
		20 m	JZSP-C7PI00-20-E	JZSP-C7PI20-20-E	
	For multi-turn absolute encoder (with Battery Case)	3 m	JZSP-C7PA00-03-E	JZSP-C7PA20-03-E	
		5 m	JZSP-C7PA00-05-E	JZSP-C7PA20-05-E	
		10 m	JZSP-C7PA00-10-E	JZSP-C7PA20-10-E	
		15 m	JZSP-C7PA00-15-E	JZSP-C7PA20-15-E	
		20 m	JZSP-C7PA00-20-E	JZSP-C7PA20-20-E	
SGM7F-□□A7 SGM7F-□□B7 SGM7F-□□C7 SGM7F-□□D7 Flange specification*2: 4	For multi-turn absolute encoder (without Battery Case*3)	3 m	JZSP-CMP00-03-E	JZSP-CMP10-03-E	
		5 m	JZSP-CMP00-05-E	JZSP-CMP10-05-E	
		10 m	JZSP-CMP00-10-E	JZSP-CMP10-10-E	
		15 m	JZSP-CMP00-15-E	JZSP-CMP10-15-E	
		20 m	JZSP-CMP00-20-E	JZSP-CMP10-20-E	
	For multi-turn absolute encoder (with Battery Case)	3 m	JZSP-CSP19-03-E	JZSP-CSP29-03-E	
		5 m	JZSP-CSP19-05-E	JZSP-CSP29-05-E	
		10 m	JZSP-CSP19-10-E	JZSP-CSP29-10-E	
		15 m	JZSP-CSP19-15-E	JZSP-CSP29-15-E	
		20 m	JZSP-CSP19-20-E	JZSP-CSP29-20-E	

*1. Use Flexible Cables for moving parts of machines, such as robots. The recommended bending radius (R) is 68 mm or larger.

*2. Refer to the following section for the flange specifications.

 Model Designations (page 160)

*3. Use one of these Cables if a battery is connected to the host controller.

◆ Relay Encoder Cables of 30 m to 50 m

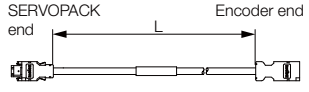
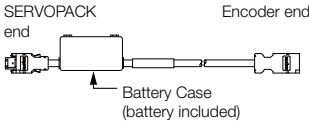
Servomotor Model	Name	Length (L)	Order Number*1	Appearance
SGM7F-□□□F SGM7F-□□□7 Flange specification*2: 1 or 3	Encoder-end Cable (for single-turn/multi-turn absolute encoder)	0.3 m	JZSP-C7PRC0-E	
SGM7F-□□□F SGM7F-□□□7 Flange specification*2: 1, 3 or 4	Cables with Connectors on Both Ends (for single-turn/multi-turn absolute encoder)	30 m	JZSP-UCMP00-30-E	
		40 m	JZSP-UCMP00-40-E	
		50 m	JZSP-UCMP00-50-E	
SGM7F-□□□7 Flange specification*2: 1, 3 or 4	Cable with a Battery Case (for multiturn absolute encoder)*3	0.3 m	JZSP-CSP12-E	

*1. Flexible Cables are not available.

*2. Refer to the following section for the flange specifications.

 Model Designations (page 160)

*3. Use one of these Cables if a battery is connected to the host controller.

SGMCMV (Small Capacity, with Core, Inner Rotor)

Model Designations

SGMCMV - 04 B E A 1 1

Direct Drive
Servomotors:
SGMCMV

1st+2nd
digits

3rd
digit

4th
digit

5th
digit

6th
digit

7th
digit

1st+2nd digits Rated Output

Code	Specification
04	4.00 N·m
08	8.00 N·m
10	10.0 N·m
14	14.0 N·m
16	16.0 N·m
17	17.0 N·m
25	25.0 N·m
35	35.0 N·m

4th digit Serial Encoder

Code	Specification
E	22-bit single-turn absolute encoder
I	22-bit multiturn absolute encoder

6th digit Flange

Code	Mounting
1	Non-load side
4	Non-load side (with cable on side)

5th digit Design Revision Order

A

7th digit Options

Code	Specification
1	Without options
5	High machine precision (runout at end of shaft and runout of shaft surface: 0.01 mm)

3rd digit Servomotor Outer Diameter

Code	Specification
B	135-mm dia.
C	175-mm dia.
D	230-mm dia.

Note: 1. Direct Drive Servomotors are not available with holding brakes.

2. This information is provided to explain model numbers. It is not meant to imply that models are available for all combinations of codes.

◆ Manufactured Models

Rated Torque N·m	Servomotor Outer Diameter		
	B (135-mm dia.)	C (175-mm dia.)	D (230-mm dia.)
4.00	SGMCMV-04B	–	–
8.00	–	SGMCMV-08C	–
10.0	SGMCMV-10B	–	–
14.0	SGMCMV-14B	–	–
16.0	–	–	SGMCMV-16D
17.0	–	SGMCMV-17C	–
25.0	–	SGMCMV-25C	–
35.0	–	–	SGMCMV-35D

Note: The above table shows combinations of the rated torque and outer diameter. The fourth through seventh digits have been omitted.

Specifications and Ratings

Specifications

Voltage		200 V							
Model SGMCV-		04B	10B	14B	08C	17C	25C	16D	35D
Time Rating		Continuous							
Thermal Class		A							
Insulation Resistance		500 VDC, 10 MΩ min.							
Withstand Voltage		1,500 VAC for 1 minute							
Excitation		Permanent magnet							
Mounting		Flange-mounted							
Drive Method		Direct drive							
Rotation Direction		Counterclockwise (CCW) for forward reference when viewed from the load side							
Vibration Class* ¹		V15							
Absolute Accuracy		±15 s							
Repeatability		±1.3 s							
Protective Structure* ²		Totally enclosed, self-cooled, IP42							
Environmental Conditions	Surrounding Air Temperature	0°C to 40°C (with no freezing)							
	Surrounding Air Humidity	20% to 80% relative humidity (with no condensation)							
	Installation Site	<ul style="list-style-type: none"> • Must be indoors and free of corrosive and explosive gases. • Must be well-ventilated and free of dust and moisture. • Must facilitate inspection and cleaning. • Must have an altitude of 1,000 m or less. • Must be free of strong magnetic fields. 							
	Storage Environment	Store the Servomotor in the following environment if you store it with the power cable disconnected. Storage Temperature: -20°C to 60°C (with no freezing) Storage Humidity: 20% to 80% relative humidity (with no condensation)							
Mechanical Tolerances* ³	Runout of Output Shaft Surface	mm	0.02 (0.01 for high machine precision option)						
	Runout at End of Output Shaft	mm	0.04 (0.01 for high machine precision option)						
	Parallelism between Mounting Surface and Output Shaft Surface	mm	0.07						
	Concentricity between Output Shaft and Flange Outer Diameter	mm	0.07						
Shock Resistance* ⁴	Impact Acceleration Rate at Flange	490 m/s ²							
	Number of Impacts	2 times							
Vibration Resistance* ⁴	Vibration Acceleration Rate at Flange	49 m/s ²							
Applicable SERVOPACKs		SGD7S-	2R8A, 2R8F	5R5A	2R8A, 2R8F	5R5A	7R6A	5R5A	7R6A* ⁵ , 120A
		SGD7W-SGD7C-	2R8A		2R8A				7R6A* ⁵

*1. A vibration class of V15 indicates a vibration amplitude of 15 μm maximum on the Servomotor without a load at the rated motor speed.

*2. The hollow hole section, motor mounting surface, output shaft surface, and gap around the rotating part of the shaft are excluded. Protective structure specifications apply only when the special cable is used.

*3. Refer to the following figure for the relevant locations on the Servomotor. Refer to the dimensional drawings of the individual Servomotors for more information on tolerances.

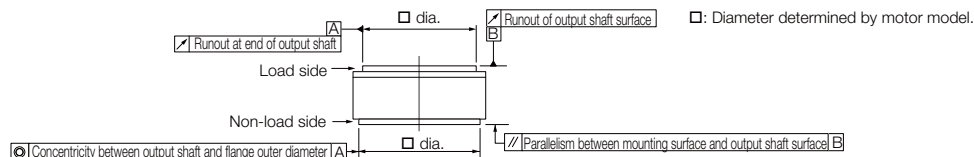

*4. The given values are for when the Servomotor shaft is mounted horizontally and shock or vibration is applied in the directions shown in the following figures. The strength of the vibration that the Servomotor can withstand depends on the application. Check the vibration acceleration rate.

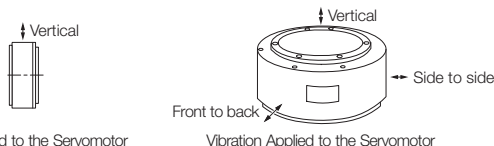

*5. Use derated values for this combination. Refer to the following section for information on derating values.

Ratings (page 184)

Ratings

Voltage		200 V								
Model SGMVCV-		04B	10B	14B	08C	17C	25C	16D	35D	
Rated Output* ¹	W	126	314	440	251	534	785	503	1100 1000* ⁵	
Rated Torque* ^{1, *2}	N·m	4.00	10.0	14.0	8.00	17.0	25.0	16.0	35.0	
Instantaneous Maximum Torque* ¹	N·m	12.0	30.0	42.0	24.0	51.0	75.0	48.0	105	
Stall Torque* ¹	N·m	4.00	10.0	14.0	8.00	17.0	25.0	16.0	35.0	
Rated Current* ¹	Arms	2.0	2.8	4.6	2.4	4.5		5.0		
Instantaneous Maximum Current* ¹	Arms	6.4	8.9	14.1	8.6	14.7	13.9	16.9	16.0	
Rated Motor Speed* ¹	min ⁻¹	300			300				300 270* ⁵	
Maximum Motor Speed* ¹	min ⁻¹	600			600		500	600	400	
Torque Constant	N·m/Arms	2.21	3.81	3.27	3.52	4.04	6.04	3.35	7.33	
Motor Moment of Inertia	×10 ⁻⁴ kg·m ²	16.2	25.2	36.9	56.5	78.5	111	178	276	
Rated Power Rate* ¹	kW/s	9.88	39.7	53.1	11.3	36.8	56.3	14.4	44.4	
Rated Angular Acceleration Rate* ¹	rad/s ²	2470	3970	3790	1420	2170	2250	899	1270	
Heat Sink Size	mm	350 × 350 × 12			450 × 450 × 12			550 × 550 × 12		
Allowable Load Moment of Inertia (Motor Moment of Inertia Ratio)		25	40	45	15	25	25	10	15	
		times	times	times	times	times	times	times	times	
		25	40	45	15	25	25	10	15	
		times	times	times	times	times	times	times	times	
Allowable Load* ⁴	Allowable Thrust Load	N	1500			3300			4000	
	Allowable Moment Load	N·m	45	55	65	92	98	110	210	225

*1. These values are for operation in combination with a SERVOPACK when the temperature of the armature winding is 100°C. The values for other items are at 20°C. These are typical values.

*2. The rated torques are the continuous allowable torque values at a surrounding air temperature of 40°C with a steel heat sink of the dimensions given in the table.

*3. To externally connect dynamic brake resistor, select hardware option specification 020 for the SERVOPACK. However, you cannot externally connect dynamic brake resistor if you use the following SERVOPACKs (maximum applicable motor capacity: 400 W).

- SGD7S-R70□□□A020 to -2R8□□□A020
- SGD7W-1R6A20A020 to -2R8A20A020
- SGD7C-1R6AMAA020 to -2R8AMAA020

*4. The thrust loads and moment loads that are applied while a Servomotor is operating are roughly classified into the following patterns. Design the machine so that the thrust loads or moment loads will not exceed the values given in the table.

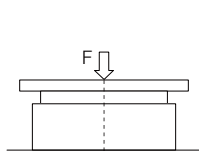

Where F is the external force,
Thrust load = F + Load mass
Moment load = 0

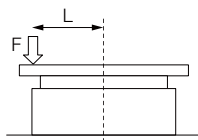

Where F is the external force,
Thrust load = F + Load mass
Moment load = F × L

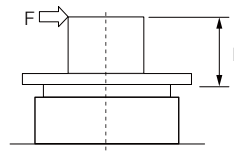

Where F is the external force,
Thrust load = Load mass
Moment load = F × L

*5. If you use an SGD7S-7R6A SERVOPACK and SGMVCV-35D Servomotor together, use this value (a derated value).

Note: For the bearings used in these Servomotors, the loss depends on the bearing temperature. The amount of heat loss is higher at low temperatures.

Torque-Motor Speed Characteristics

A : Continuous duty zone ——— (solid lines): With three-phase 200-V or single-phase 230-V input
B : Intermittent duty zone - - - - - (dotted lines): With single-phase 200-V input
 - - - (dashed-dotted lines): With single-phase 100-V input

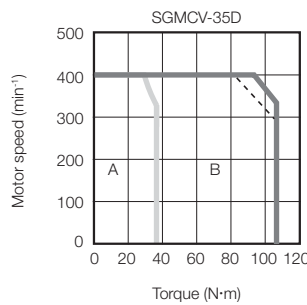
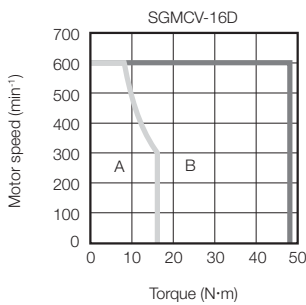
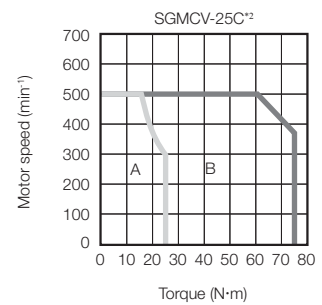
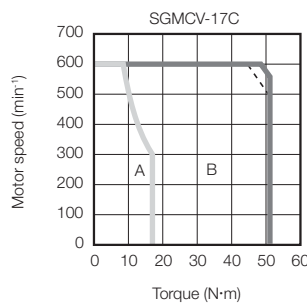
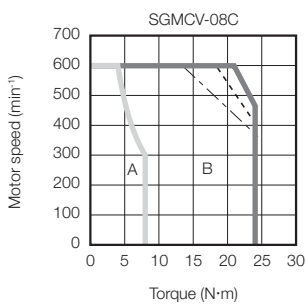
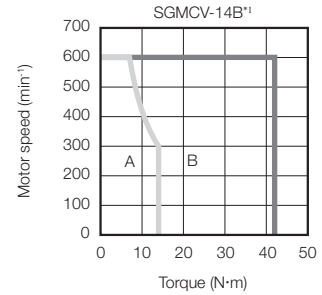
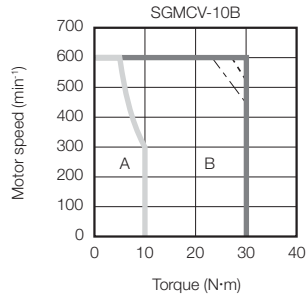
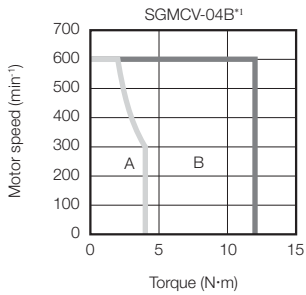

*1. The characteristics are the same for three-phase 200 V, single-phase 200 V, and single-phase 100 V.

*2. Contact your Yaskawa representative for information on the SGMCV-25C.

Note: 1. These values (typical values) are for operation in combination with a SERVOPACK when the temperature of the armature winding is 100°C.

2. The characteristics in the intermittent duty zone depend on the power supply voltage.
3. If you use a Servomotor Main Circuit Cable that exceeds 20 m, the intermittent duty zone in the torque-motor speed characteristics will become smaller because the voltage drop increases.

Servomotor Overload Protection Characteristics

The overload detection level is set for hot start conditions with a Servomotor surrounding air temperature of 40°C.

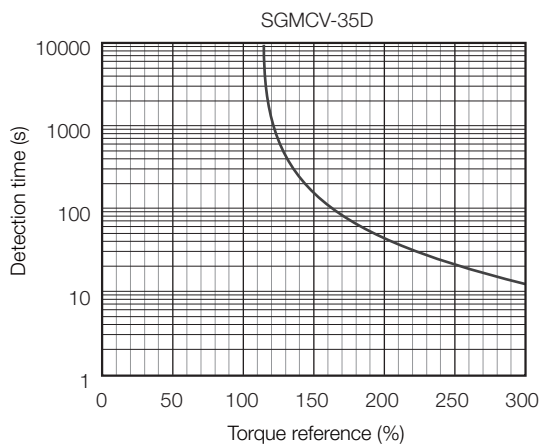
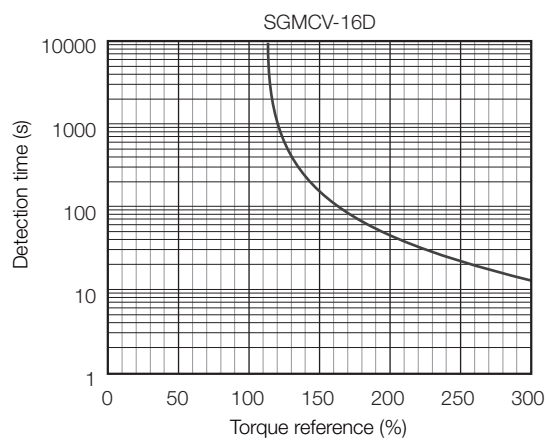
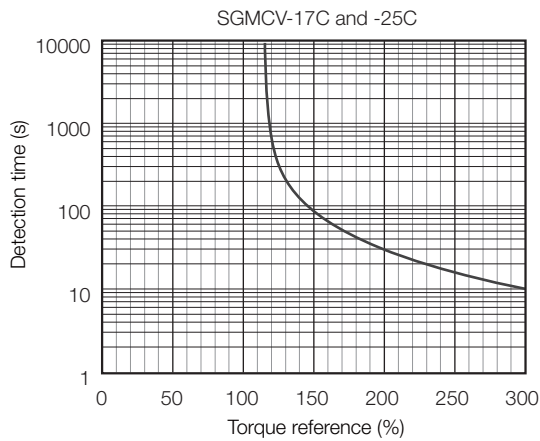
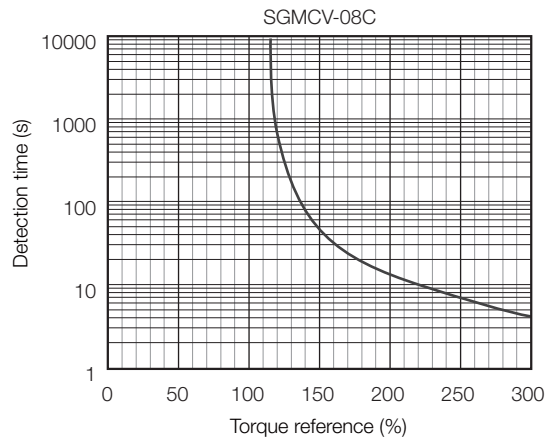
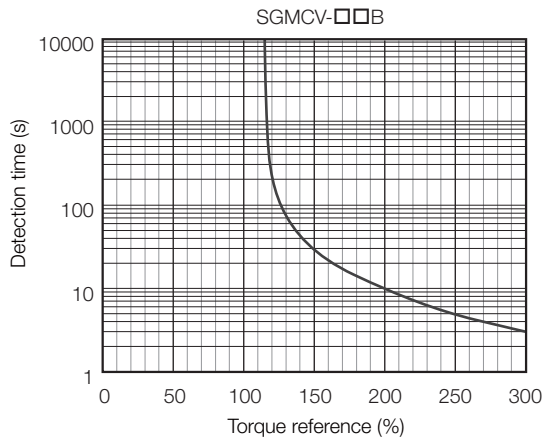

Note: The above overload protection characteristics do not mean that you can perform continuous duty operation with an output of 100% or higher. Use the Servomotor so that the effective torque remains within the continuous duty zone given in *Torque-Motor Speed Characteristics* on page 185.

Allowable Load Moment of Inertia

The allowable load moments of inertia (motor moment of inertia ratios) for the Servomotors are given in the *Ratings* (page 184). The values are determined by the regenerative energy processing capacity of the SERVOPACK and are also affected by the drive conditions of the Servomotor. Perform the required Steps for each of the following cases.

Use the SigmaSize+ AC Servo Drive Capacity Selection Program to check the driving conditions. Contact your Yaskawa representative for information on this program.

◆ Exceeding the Allowable Load Moment of Inertia

Use one of the following measures to adjust the load moment of inertia to within the allowable value.

- Reduce the torque limit.
- Reduce the deceleration rate.
- Reduce the maximum motor speed.

If the above steps is not possible, install an external regenerative resistor.

Information

An Overvoltage Alarm (A.400) is likely to occur during deceleration if the load moment of inertia exceeds the allowable load moment of inertia. SERVOPACKs with a built-in regenerative resistor may generate a Regenerative Overload Alarm (A.320). Refer to *Built-In Regenerative Resistor* (page 472) for the regenerative power (W) that can be processed by the SERVOPACKs.

Install an External Regenerative Resistor when the built-in regenerative resistor cannot process all of the regenerative power.

◆ SERVOPACKs without Built-in Regenerative Resistors

The following graph shows the allowable load moment of inertia scaling factor of the motor speed (reference values for deceleration operation at or above the rated torque). Application is possible without an external regenerative resistor within the allowable value. However, an External Regenerative Resistor is required in the shaded areas of the graphs.

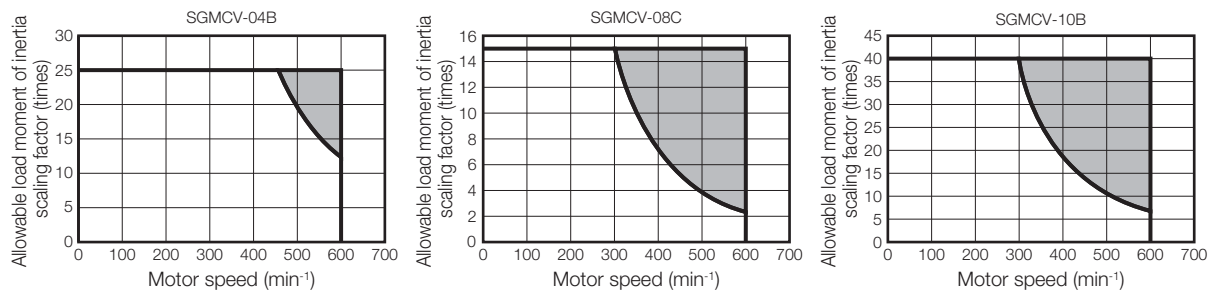

Note: Applicable SERVOPACK models: SGD7S-2R8A and -2R8F

◆ When an External Regenerative Resistor Is Required

Install the External Regenerative Resistor. Refer to the following section for the recommended products.

[External Regenerative Resistors](#) (page 472)

External Dimensions

◆ SGMCV-□□B

• Flange Specification 1

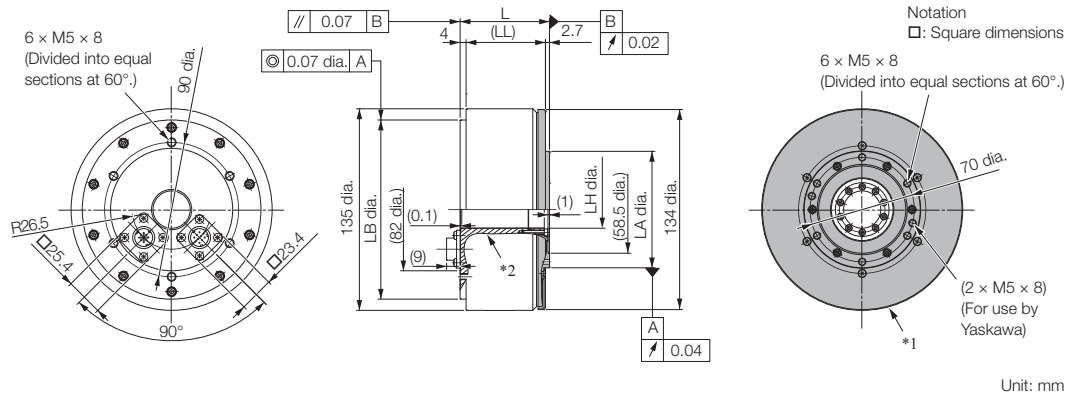

- *1. The shaded section indicates the rotating parts.
 - *2. The hatched section indicates the non-rotating parts.
- Note: Values in parentheses are reference dimensions.

Model SGMCV-	L	(LL)	LB	LH	LA	Approx. Mass [kg]
04B□A11	60	53.3	120 ⁰ _{-0.035}	25 ^{+0.3} _{+0.1}	78 ⁰ _{-0.030}	5.0
10B□A11	85	78.3	120 ⁰ _{-0.035}	25 ^{+0.3} _{+0.1}	78 ⁰ _{-0.030}	6.5
14B□A11	115	108.3	120 ⁰ _{-0.035}	25 ^{+0.3} _{+0.1}	78 ⁰ _{-0.030}	9.0

• Flange Specification 4

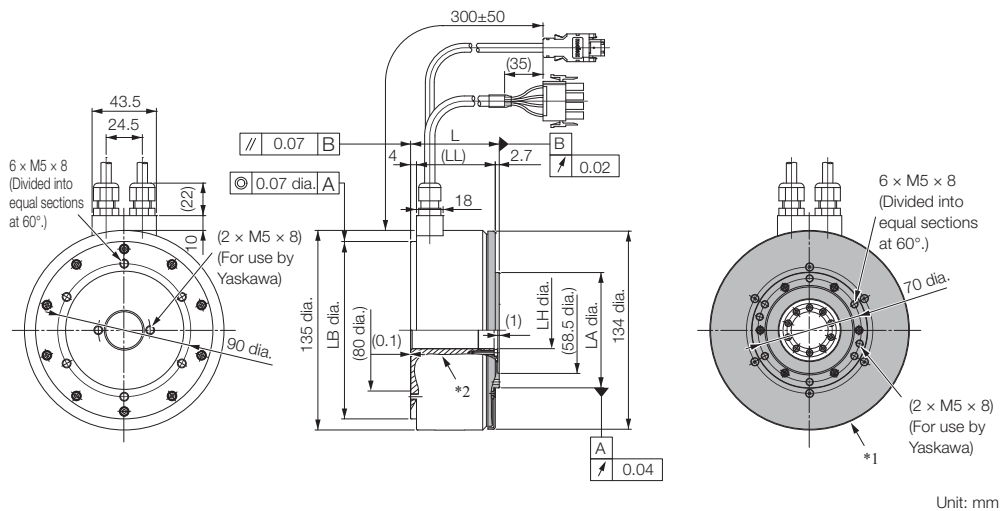

- *1. The shaded section indicates the rotating parts.
 - *2. The hatched section indicates the non-rotating parts.
- Note: Values in parentheses are reference dimensions.

Model SGMCV-	L	(LL)	LB	LH	LA	Approx. Mass [kg]
04B□A41	60	53.3	120 ⁰ _{-0.035}	25 ^{+0.3} _{+0.1}	78 ⁰ _{-0.030}	5.0
10B□A41	85	78.3	120 ⁰ _{-0.035}	25 ^{+0.3} _{+0.1}	78 ⁰ _{-0.030}	6.5
14B□A41	115	108.3	120 ⁰ _{-0.035}	25 ^{+0.3} _{+0.1}	78 ⁰ _{-0.030}	9.0

Refer to the following section for information on connectors.

🔌 Connector Specifications (page 191)

◆ SGMCV-□□C

• Flange Specification 1

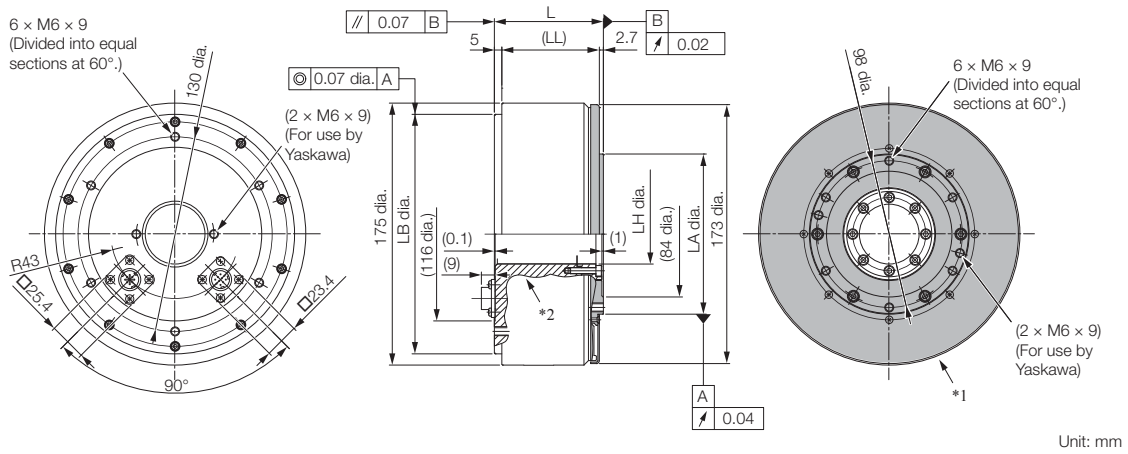

- *1. The shaded section indicates the rotating parts.
 - *2. The hatched section indicates the non-rotating parts.
- Note: Values in parentheses are reference dimensions.

Model SGMCV-	L	(LL)	LB	LH	LA	Approx. Mass [kg]
08C□A11	73	65.3	160 ⁰ _{-0.040}	40 ^{+0.3} _{+0.1}	107 ⁰ _{-0.035}	9.0
17C□A11	87	79.3	160 ⁰ _{-0.040}	40 ^{+0.3} _{+0.1}	107 ⁰ _{-0.035}	11.0
25C□A11	117	109.3	160 ⁰ _{-0.040}	40 ^{+0.3} _{+0.1}	107 ⁰ _{-0.035}	15.0

• Flange Specification 4

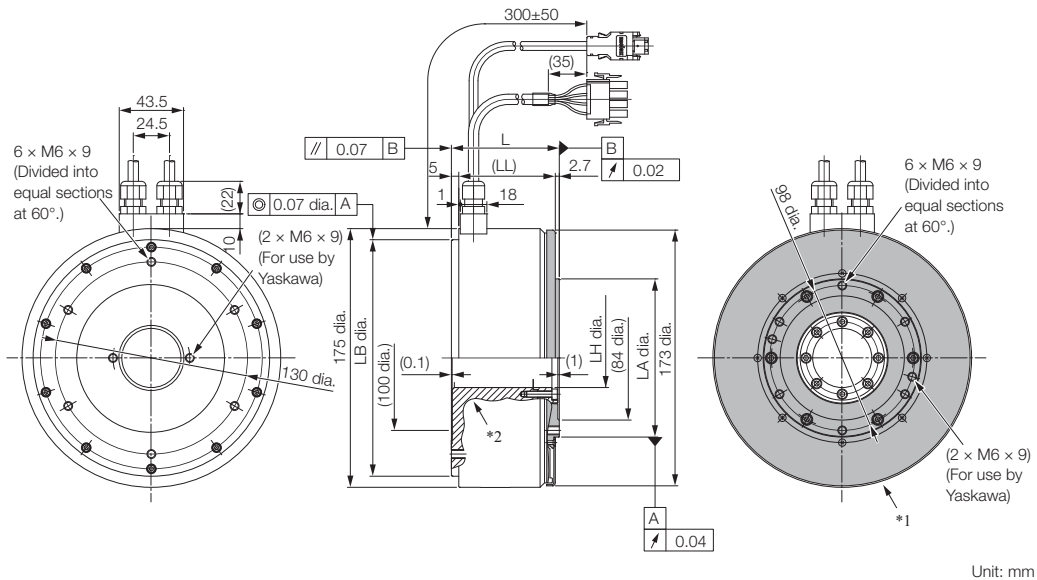

- *1. The shaded section indicates the rotating parts.
 - *2. The hatched section indicates the non-rotating parts.
- Note: Values in parentheses are reference dimensions.

Model SGMCV-	L	(LL)	LB	LH	LA	Approx. Mass [kg]
08C□A41	73	65.3	160 ⁰ _{-0.040}	40 ^{+0.3} _{+0.1}	107 ⁰ _{-0.035}	9.0
17C□A41	87	79.3	160 ⁰ _{-0.040}	40 ^{+0.3} _{+0.1}	107 ⁰ _{-0.035}	11.0
25C□A41	117	109.3	160 ⁰ _{-0.040}	40 ^{+0.3} _{+0.1}	107 ⁰ _{-0.035}	15.0

Refer to the following section for information on connectors.

☞ Connector Specifications (page 191)

◆ SGMCV-□□□

• Flange Specification 1

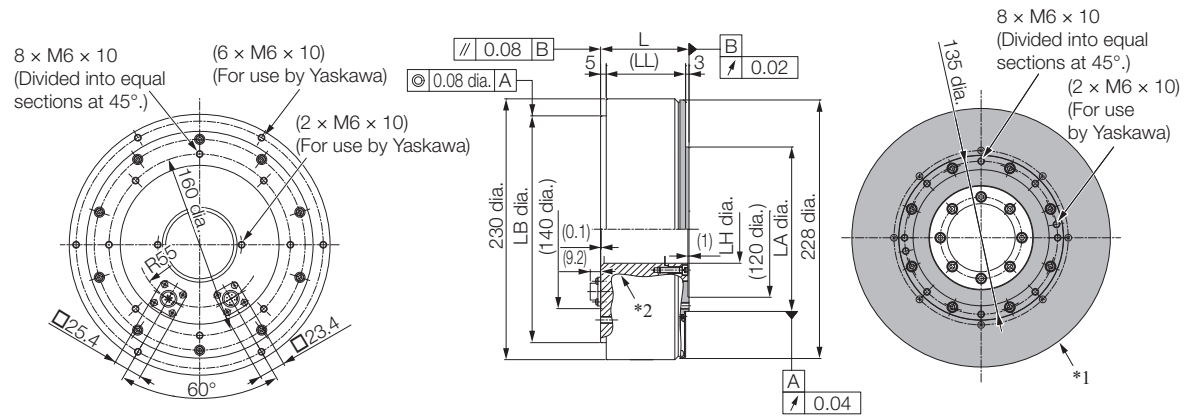

Unit: mm

- *1. The shaded section indicates the rotating parts.
 - *2. The hatched section indicates the non-rotating parts.
- Note: Values in parentheses are reference dimensions.

Model SGMCV-	L	(LL)	LB	LH	LA	Approx. Mass [kg]
16D□A11	78	70	200 ⁰ _{-0.046}	60 ^{+0.4} ₀	145 ⁰ _{-0.040}	16.0
35D□A11	107	99	200 ⁰ _{-0.046}	60 ^{+0.4} ₀	145 ⁰ _{-0.040}	25.0

• Flange Specification 4

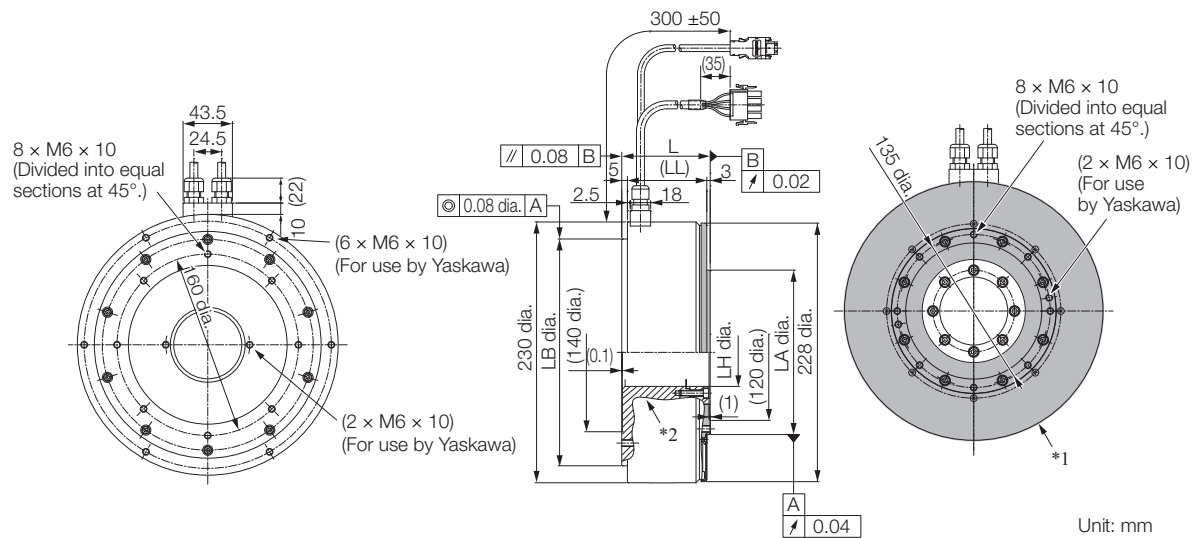

Unit: mm

- *1. The shaded section indicates the rotating parts.
 - *2. The hatched section indicates the non-rotating parts.
- Note: Values in parentheses are reference dimensions.

Model SGMCV-	L	(LL)	LB	LH	LA	Approx. Mass [kg]
16D□A41	78	70	200 ⁰ _{-0.046}	60 ^{+0.4} ₀	145 ⁰ _{-0.040}	16.0
35D□A41	107	99	200 ⁰ _{-0.046}	60 ^{+0.4} ₀	145 ⁰ _{-0.040}	25.0

Refer to the following section for information on connectors.

☞ Connector Specifications (page 191)

Connector Specifications

◆ Flange Specification 1

• Servomotor Connector

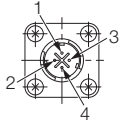

1	Phase U
2	Phase V
3	Phase W
4	FG (frame ground)

Model: JN1AS04MK2R
Manufacturer: Japan Aviation Electronics Industry, Ltd.

Mating connector: JN1DS04FK1
(Not provided by Yaskawa.)

• Encoder Connector

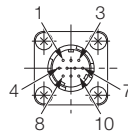

1	PS
2	/PS
3	-
4	PG5V
5*	BAT0
6	-
7	FG (frame ground)
8*	BAT
9	PG0V
10	-

* Only absolute-value models with multiturn data.

Model: JN1AS10ML1-R
Manufacturer: Japan Aviation Electronics Industry, Ltd.

Mating connector: JN1DS10SL1
(Not provided by Yaskawa.)

◆ Flange Specification 4

• Servomotor Connector

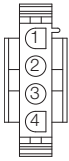

1	Phase U	Red
2	Phase V	White
3	Phase W	Blue
4	FG (frame ground)	Green (yellow)

Models

- Plug: 350779-1
- Pins: 350561-3 or 350690-3 (No.1 to 3)
- Ground pin: 350654-1 or 350669-1 (No. 4)
- Manufacturer: Tyco Electronics Japan G.K.

Mating Connector

- Cap: 350780-1
- Socket: 350570-3 or 350689-3

• Encoder Connector

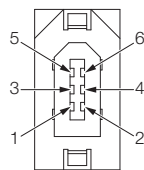

1	PG5V
2	PG0V
3*	BAT
4*	BAT0
5	PS
6	/PS
Connector case	FG (frame ground)

* Only absolute-value models with multiturn data.

Model: 55102-0600
Manufacturer: Molex Japan LLC

Mating connector: 54280-0609

Selecting Cables

◆ Cable Configurations

The cables shown below are required to connect a Servomotor to a SERVOPACK.

Encoder Cable of 20 m or Less

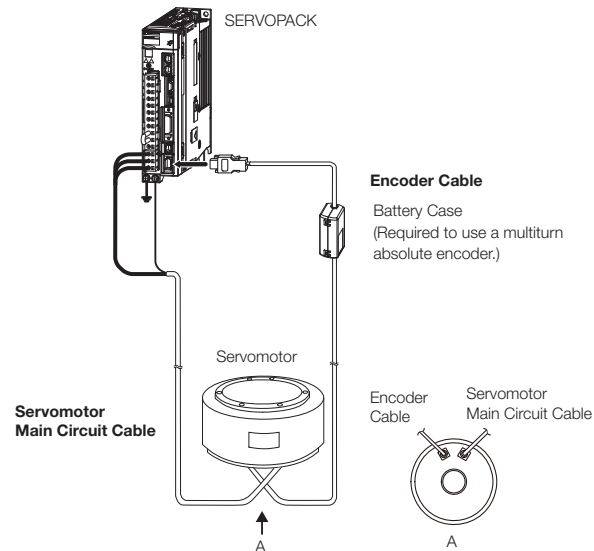

Encoder Cable of 30 m to 50 m (Relay Cable)

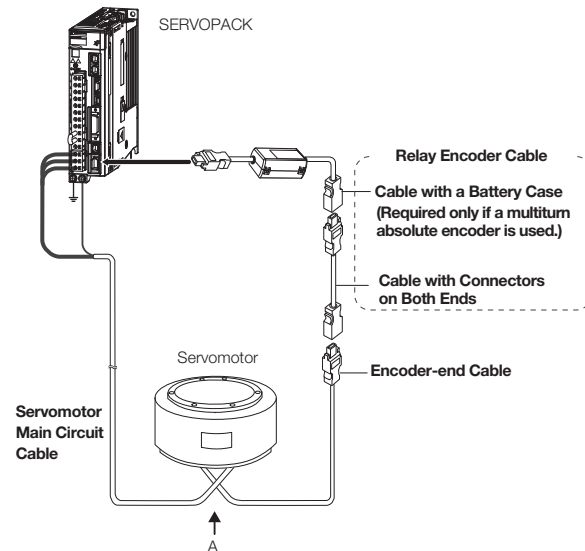

Note: 1. If the Encoder Cable length exceeds 20 m, be sure to use a Relay Encoder Cable.

2. If you use a Servomotor Main Circuit Cable that exceeds 20 m, the intermittent duty zone in the torque-motor speed characteristics will become smaller because the voltage drop increases.

3. Refer to the following manual for the following information.

- Cable dimensional drawings and cable connection specifications
- Order numbers and specifications of individual connectors for cables
- Order numbers and specifications for wiring materials

☞ *Σ-7-Series AC Servo Drive Peripheral Device Selection Manual (Manual No.: SIEP S800001 32)*

◆ Servomotor Main Circuit Cables

Servomotor Model	Length (L)	Order Number		Appearance
		Standard Cable	Flexible Cable*1	
SGMVCV-□□B SGMVCV-□□C SGMVCV-□□D Flange specification*2: 1 Non-load side installation	3 m	JZSP-CMM60-03-E	JZSP-C7MDN23-03-E	
	5 m	JZSP-CMM60-05-E	JZSP-C7MDN23-05-E	
	10 m	JZSP-CMM60-10-E	JZSP-C7MDN23-10-E	
	15 m	JZSP-CMM60-15-E	JZSP-C7MDN23-15-E	
	20 m	JZSP-CMM60-20-E	JZSP-C7MDN23-20-E	
SGMVCV-□□B SGMVCV-□□C SGMVCV-□□D Flange specification*2: 4 Non-load side installation (with cable on side)	3 m	JZSP-CMM00-03-E	JZSP-C7MDS23-03-E	
	5 m	JZSP-CMM00-05-E	JZSP-C7MDS23-05-E	
	10 m	JZSP-CMM00-10-E	JZSP-C7MDS23-10-E	
	15 m	JZSP-CMM00-15-E	JZSP-C7MDS23-15-E	
	20 m	JZSP-CMM00-20-E	JZSP-C7MDS23-20-E	

*1. Use Flexible Cables for moving parts of machines, such as robots. The recommended bending radius (R) is 90 mm or larger.

*2. Refer to the following section for the flange specifications.

☞ *Model Designations (page 182)*

Note: Direct Drive Servomotors are not available with holding brakes.

◆ Encoder Cables of 20 m or Less

Servomotor Model	Name	Length (L)	Order Number		Appearance
			Standard Cable	Flexible Cable *1	
SGMCV-□□BE SGMCV-□□CE SGMCV-□□DE Flange specification*2: 1	For single-turn absolute encoder (without Battery Case)	3 m	JZSP-CMP60-03-E	JZSP-CSP60-03-E	
		5 m	JZSP-CMP60-05-E	JZSP-CSP60-05-E	
		10 m	JZSP-CMP60-10-E	JZSP-CSP60-10-E	
		15 m	JZSP-CMP60-15-E	JZSP-CSP60-15-E	
		20 m	JZSP-CMP60-20-E	JZSP-CSP60-20-E	
SGMCV-□□BE SGMCV-□□CE SGMCV-□□DE Flange specification*2: 4	For multi-turn absolute encoder (with Battery Case)	3 m	JZSP-CMP00-03-E	JZSP-CMP10-03-E	
		5 m	JZSP-CMP00-05-E	JZSP-CMP10-05-E	
		10 m	JZSP-CMP00-10-E	JZSP-CMP10-10-E	
		15 m	JZSP-CMP00-15-E	JZSP-CMP10-15-E	
		20 m	JZSP-CMP00-20-E	JZSP-CMP10-20-E	
SGMCV-□□BI SGMCV-□□CI SGMCV-□□DI Flange specification*2: 1	For multi-turn absolute encoder (without Battery Case*3)	3 m	JZSP-C7PI00-03-E	JZSP-C7PI20-03-E	
		5 m	JZSP-C7PI00-05-E	JZSP-C7PI20-05-E	
		10 m	JZSP-C7PI00-10-E	JZSP-C7PI20-10-E	
		15 m	JZSP-C7PI00-15-E	JZSP-C7PI20-15-E	
		20 m	JZSP-C7PI00-20-E	JZSP-C7PI20-20-E	
	For multi-turn absolute encoder (with Battery Case)	3 m	JZSP-C7PA00-03-E	JZSP-C7PA20-03-E	
		5 m	JZSP-C7PA00-05-E	JZSP-C7PA20-05-E	
		10 m	JZSP-C7PA00-10-E	JZSP-C7PA20-10-E	
		15 m	JZSP-C7PA00-15-E	JZSP-C7PA20-15-E	
		20 m	JZSP-C7PA00-20-E	JZSP-C7PA20-20-E	
SGMCV-□□BI SGMCV-□□CI SGMCV-□□DI Flange specification*2: 4	For multi-turn absolute encoder (without Battery Case*3)	3 m	JZSP-CMP00-03-E	JZSP-CMP10-03-E	
		5 m	JZSP-CMP00-05-E	JZSP-CMP10-05-E	
		10 m	JZSP-CMP00-10-E	JZSP-CMP10-10-E	
		15 m	JZSP-CMP00-15-E	JZSP-CMP10-15-E	
		20 m	JZSP-CMP00-20-E	JZSP-CMP10-20-E	
	For multi-turn absolute encoder (with Battery Case)	3 m	JZSP-CSP19-03-E	JZSP-CSP29-03-E	
		5 m	JZSP-CSP19-05-E	JZSP-CSP29-05-E	
		10 m	JZSP-CSP19-10-E	JZSP-CSP29-10-E	
		15 m	JZSP-CSP19-15-E	JZSP-CSP29-15-E	
		20 m	JZSP-CSP19-20-E	JZSP-CSP29-20-E	

*1. Use Flexible Cables for moving parts of machines, such as robots. The recommended bending radius (R) is 68 mm or larger.

*2. Refer to the following section for the flange specifications.

Model Designations (page 182)

*3. Use one of these Cables if a battery is connected to the host controller.

◆ Relay Encoder Cables of 30 m to 50 m

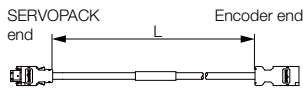
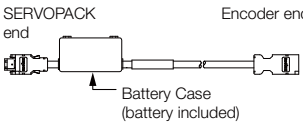
Servomotor Model	Name	Length (L)	Order Number*1	Appearance
SGMCV-□□BE SGMCV-□□BI SGMCV-□□CE SGMCV-□□CI SGMCV-□□DE SGMCV-□□DI Flange specification*2: 1	Encoder-end Cable (for single-turn/multi-turn absolute encoder)	0.3 m	JZSP-C7PRC0-E	
SGMCV-□□BE SGMCV-□□BI SGMCV-□□CE SGMCV-□□CI SGMCV-□□DE SGMCV-□□DI Flange specification*2: 1 or 4	Cables with Connectors on Both Ends (for single-turn/multi-turn absolute encoder)	30 m	JZSP-UCMP00-30-E	
		40 m	JZSP-UCMP00-40-E	
		50 m	JZSP-UCMP00-50-E	
SGMCV-□□BI SGMCV-□□CI SGMCV-□□DI Flange specification*2: 1 or 4	Cable with a Battery Case (for multiturn absolute encoder)*3	0.3 m	JZSP-CSP12-E	

*1. Flexible Cables are not available.

*2. Refer to the following section for the flange specifications.

 Model Designations (page 182)

*3. Use one of these Cables if a battery is connected to the host controller.

MEMO

SGMCS (Small Capacity, Coreless, Inner Rotor or Medium Capacity, with Core, Inner Rotor)

Model Designations

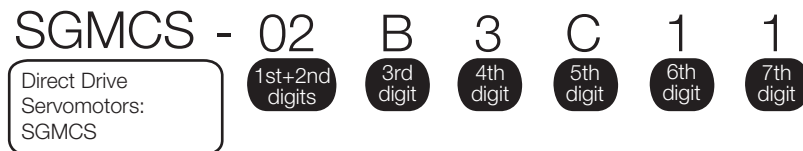

1st+2nd digits Rated Output

- Small-Capacity, Coreless

Code	Specification
02	2.00 N·m
04	4.00 N·m
05	5.00 N·m
07	7.00 N·m
08	8.00 N·m
10	10.0 N·m
14	14.0 N·m
16	16.0 N·m
17	17.0 N·m
25	25.0 N·m
35	35.0 N·m

- Medium-Capacity, with Core

Code	Specification
45	45.0 N·m
80	80.0 N·m
1A	110 N·m
1E	150 N·m
2Z	200 N·m

3rd digit Servomotor Outer Diameter

Code	Specification
B	135-mm dia.
C	175-mm dia.
D	230-mm dia.
E	290-mm dia.
M	280-mm dia.
N	360-mm dia.

4th digit Serial Encoder

Code	Specification
3	20-bit single-turn absolute encoder
D	20-bit incremental encoder

5th digit Design Revision Order

Code	Specification
A	Model with servomotor outer diameter code M or N
B	Model with servomotor outer diameter code E
C	Model with servomotor outer diameter code B, C, or D

6th digit Flange

Code	Mounting	Servomotor Outer Diameter Code (3rd Digit)					
		B	C	D	E	M	N
1	Non-load side	✓	✓	✓	✓	-	-
	Load side	-	-	-	-	✓	✓
3	Non-load side	-	-	-	-	✓	✓
4	Non-load side (with cable on side)	✓	✓	✓	✓	-	-

✓ : Applicable models.

7th digit Options

Code	Specification
1	Without options

Note: 1. Direct Drive Servomotors are not available with holding brakes.

2. This information is provided to explain model numbers. It is not meant to imply that models are available for all combinations of codes.

◆ Manufactured Models

Rated Torque N·m	Servomotor Outer Diameter					
	B (135-mm dia.)	C (175-mm dia.)	D (230-mm dia.)	E (290-mm dia.)	M (280-mm dia.)	N (360-mm dia.)
2.00	SGMCS-02B	-	-	-	-	-
4.00	-	SGMCS-04C	-	-	-	-
5.00	SGMCS-05B	-	-	-	-	-
7.00	SGMCS-07B	-	-	-	-	-
8.00	-	-	SGMCS-08D	-	-	-
10.0	-	SGMCS-10C	-	-	-	-
14.0	-	SGMCS-14C	-	-	-	-
16.0	-	-	-	SGMCS-16E	-	-
17.0	-	-	SGMCS-17D	-	-	-
25.0	-	-	SGMCS-25D	-	-	-
35.0	-	-	-	SGMCS-35E	-	-
45.0	-	-	-	-	SGMCS-45M	-
80.0	-	-	-	-	SGMCS-80M	SGMCS-80N
110	-	-	-	-	SGMCS-1AM	-
150	-	-	-	-	-	SGMCS-1EN
200	-	-	-	-	-	SGMCS-2ZN

Note: The above table shows combinations of the rated torque and outer diameter. The fourth through seventh digits have been omitted.

Specifications and Ratings

Small-Capacity, Coreless Servomotors: Specifications

Voltage		200 V										
Model SGMCS-		02B	05B	07B	04C	10C	14C	08D	17D	25D	16E	35E
Time Rating		Continuous										
Thermal Class		A										
Insulation Resistance		500 VDC, 10 M Ω min.										
Withstand Voltage		1,500 VAC for 1 minute										
Excitation		Permanent magnet										
Mounting		Flange-mounted										
Drive Method		Direct drive										
Rotation Direction		Counterclockwise (CCW) for forward reference when viewed from the load side										
Vibration Class* ¹		V15										
Absolute Accuracy		± 15 s										
Repeatability		± 1.3 s										
Protective Structure* ²		Totally enclosed, self-cooled, IP42										
Environmental Conditions	Surrounding Air Temperature	0°C to 40°C (with no freezing)										
	Surrounding Air Humidity	20% to 80% relative humidity (with no condensation)										
	Installation Site	<ul style="list-style-type: none"> • Must be indoors and free of corrosive and explosive gases. • Must be well-ventilated and free of dust and moisture. • Must facilitate inspection and cleaning. • Must have an altitude of 1,000 m or less. • Must be free of strong magnetic fields. 										
	Storage Environment	Store the Servomotor in the following environment if you store it with the power cable disconnected. Storage Temperature: -20°C to 60°C (with no freezing) Storage Humidity: 20% to 80% relative humidity (with no condensation)										
Mechanical Tolerances* ³	Runout of Output Shaft Surface	mm	0.02									
	Runout at End of Output Shaft	mm	0.04									
	Parallelism between Mounting Surface and Output Shaft Surface	mm	0.07				0.08					
	Concentricity between Output Shaft and Flange Outer Diameter	mm	0.07				0.08					
Shock Resistance* ⁴	Impact Acceleration Rate at Flange	490 m/s ²										
	Number of Impacts	2 times										
Vibration Resistance* ⁴	Vibration Acceleration Rate at Flange	49 m/s ²										
	Applicable SERVOPACKs	SGD7S-	2R8A, 2R1F		2R8A, 2R8F					5R5A		
		SGD7W-SGD7C-	2R8A									

*1. A vibration class of V15 indicates a vibration amplitude of 15 μm maximum on the Servomotor without a load at the rated motor speed.

*2. The hollow hole section, motor mounting surface, output shaft surface, and gap around the rotating part of the shaft are excluded. Protective structure specifications apply only when the special cable is used.

*3. Refer to the following figure for the relevant locations on the Servomotor. Refer to the dimensional drawings of the individual Servomotors for more information on tolerances.

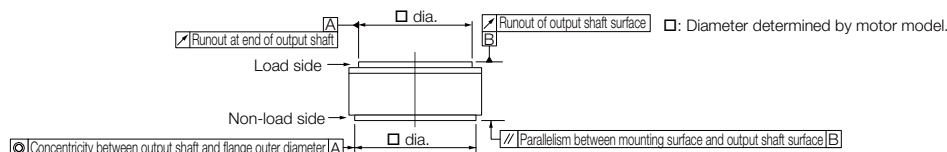

*4. The given values are for when the Servomotor shaft is mounted horizontally and shock or vibration is applied in the directions shown in the following figures. The strength of the vibration that the Servomotor can withstand depends on the application. Check the vibration acceleration rate.

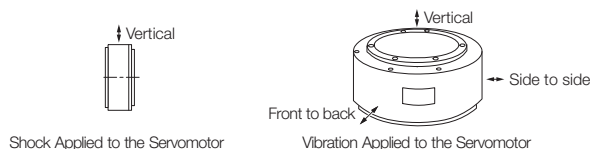

Small-Capacity, Coreless Servomotors: Ratings

Voltage		200 V										
Model SGMCS-		02B	05B	07B	04C	10C	14C	08D	17D	25D	16E	35E
Rated Output* ¹	W	42	105	147	84	209	293	168	356	393	335	550
Rated Torque* ^{1, *2}	N·m	2.00	5.00	7.00	4.00	10.0	14.0	8.00	17.0	25.0	16.0	35.0
Instantaneous Maximum Torque* ¹	N·m	6.00	15.0	21.0	12.0	30.0	42.0	24.0	51.0	75.0	48.0	105
Stall Torque* ¹	N·m	2.05	5.15	7.32	4.09	10.1	14.2	8.23	17.4	25.4	16.5	35.6
Rated Current* ¹	Arms	1.8	1.7	1.4	2.2		2.8	1.9	2.5	2.6	3.3	3.5
Instantaneous Maximum Current* ¹	Arms	5.4	5.1	4.1	7.0		8.3	5.6	7.5	8.0	9.4	10.0
Rated Motor Speed* ¹	min ⁻¹	200			200			200		150	200	150
Maximum Motor Speed* ¹	min ⁻¹	500			500	400	300	500	350	250	500	250
Torque Constant	N·m/Arms	1.18	3.17	5.44	2.04	5.05	5.39	5.10	7.79	10.8	5.58	11.1
Motor Moment of Inertia	×10 ⁻⁴ kg·m ²	28.0	51.0	77.0	77.0	140	220	285	510	750	930	1430
Rated Power Rate* ¹	kW/s	1.43	4.90	6.36	2.08	7.14	8.91	2.25	5.67	8.33	2.75	8.57
Rated Angular Acceleration Rate* ¹	rad/s ²	710	980	910	520	710	640	280	330		170	240
Heat Sink Size	mm	350 × 350 × 12			450 × 450 × 12			550 × 550 × 12			650 × 650 × 12	
Allowable Load Moment of Inertia (Motor Moment of Inertia Ratio)		10 times			5 times	3 times						
	With External Regenerative Resistor and External Dynamic Brake Resistor* ³	10 times			5 times	3 times						
Allowable Load* ⁴	Allowable Thrust Load	N	1500			3300			4000		11000	
	Allowable Moment Load	N·m	40	50	64	70	75	90	93	103	135	250

*1. These values are for operation in combination with a SERVOPACK when the temperature of the armature winding is 100°C. The values for other items are at 20°C. These are typical values.

*2. The rated torques are the continuous allowable torque values at a surrounding air temperature of 40°C with a steel heat sink of the dimensions given in the table.

*3. To externally connect dynamic brake resistor, select hardware option specification 020 for the SERVOPACK. However, you cannot externally connect dynamic brake resistor if you use the following SERVOPACKs (maximum applicable motor capacity: 400 W).

- SGD7S-R70□□□A020 to -2R8□□□A020
- SGD7W-1R6A20A020 to -2R8A20A020
- SGD7C-1R6AMAA020 to -2R8AMAA020

*4. The thrust loads and moment loads that are applied while a Servomotor is operating are roughly classified into the following patterns. Design the machine so that the thrust loads or moment loads will not exceed the values given in the table.

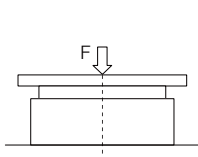

Where F is the external force,
Thrust load = F + Load mass
Moment load = 0

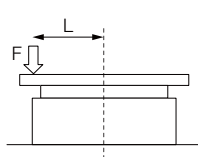

Where F is the external force,
Thrust load = F + Load mass
Moment load = F × L

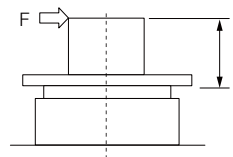

Where F is the external force
Thrust load = Load mass
Moment load = F × L

Note: For the bearings used in these Servomotors, the loss depends on the bearing temperature. The amount of heat loss is higher at low temperatures.

Small-Capacity, Coreless Servomotors: Torque-Motor Speed Characteristics

A : Continuous duty zone — (solid lines): With three-phase 200-V input
B : Intermittent duty zone - - - (dotted lines): With single-phase 100-V input

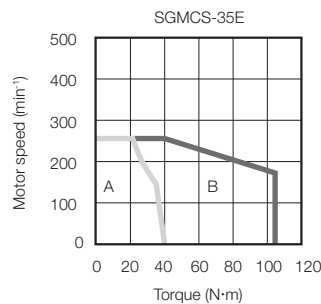
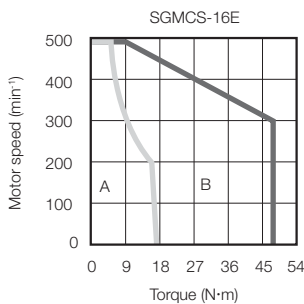
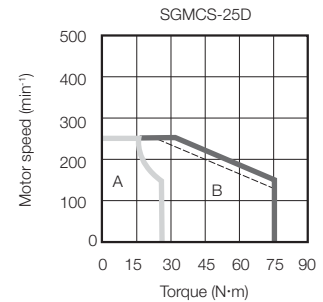
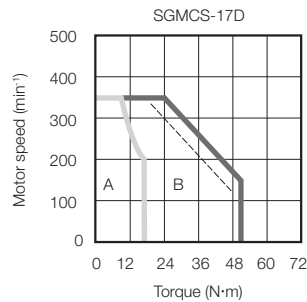
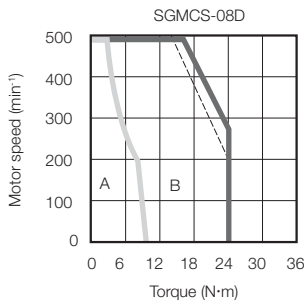
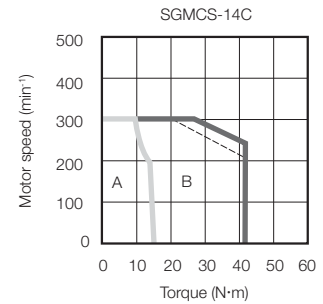
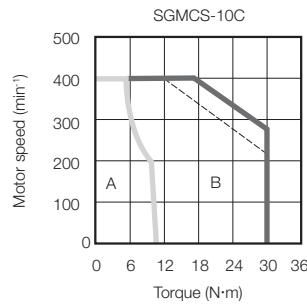
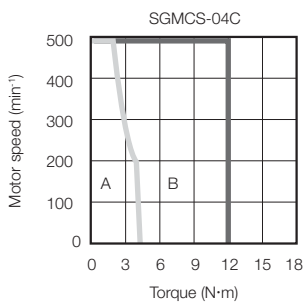
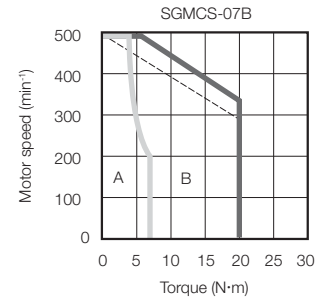
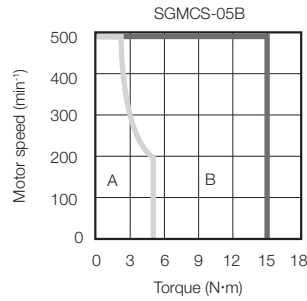
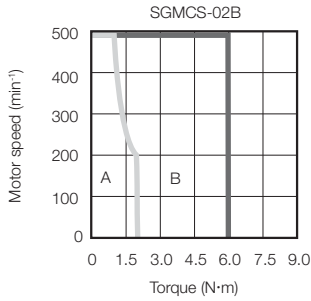

- Note: 1. These values (typical values) are for operation in combination with a SERVOPACK when the temperature of the armature winding is 100°C.
 2. The characteristics in the intermittent duty zone depend on the power supply voltage.
 3. If the effective torque is within the allowable range for the rated torque, the Servomotor can be used within the intermittent duty zone.
 4. If you use a Servomotor Main Circuit Cable that exceeds 20 m, the intermittent duty zone in the torque-motor speed characteristics will become smaller because the voltage drop increases.

Small-Capacity, Coreless Servomotors: Servomotor Overload Protection Characteristics

The overload detection level is set for hot start conditions with a Servomotor surrounding air temperature of 40°C.

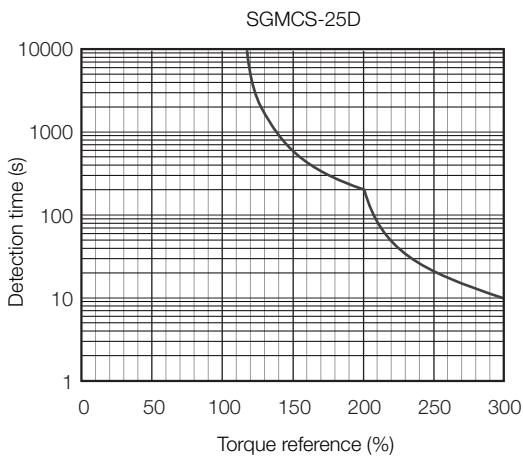
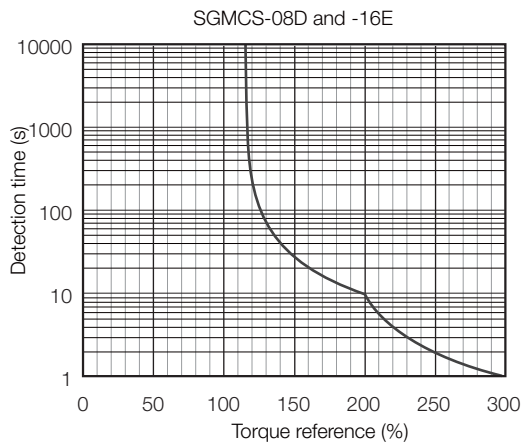
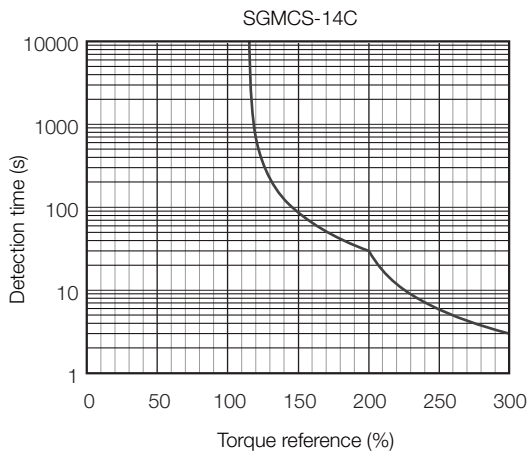
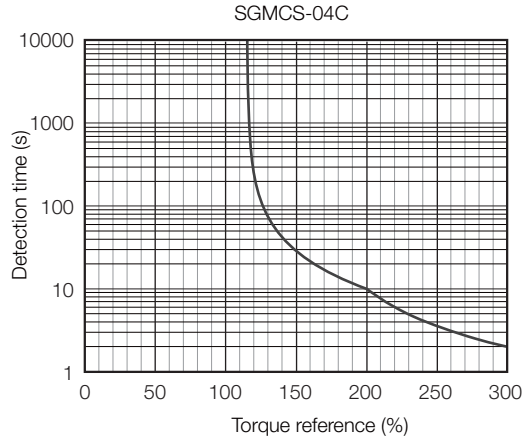
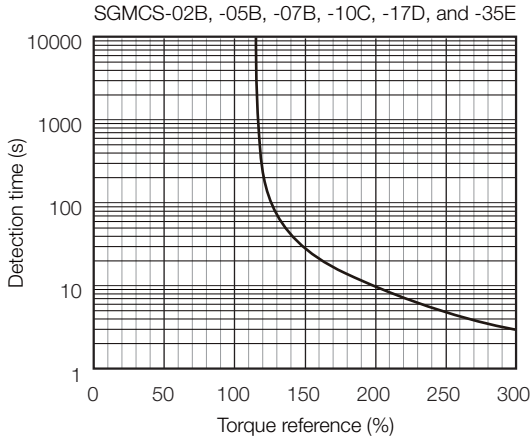

Note: The above overload protection characteristics do not mean that you can perform continuous duty operation with an output of 100% or higher. Use the Servomotor so that the effective torque remains within the continuous duty zone given in *Small-Capacity, Coreless Servomotors: Torque-Motor Speed Characteristics* on page 199.

Medium-Capacity Servomotors with Cores: Specifications

Voltage		200 V					
Model SGMCS-		45M	80M	1AM	80N	1EN	2ZN
Time Rating		Continuous					
Thermal Class		F					
Insulation Resistance		500 VDC, 10 MΩ min.					
Withstand Voltage		1,500 VAC for 1 minute					
Excitation		Permanent magnet					
Mounting		Flange-mounted					
Drive Method		Direct drive					
Rotation Direction		Counterclockwise (CCW) for forward reference when viewed from the load side					
Vibration Class* ¹		V15					
Absolute Accuracy		±15 s					
Repeatability		±1.3 s					
Protective Structure* ²		Totally enclosed, self-cooled, IP44					
Environmental Conditions	Surrounding Air Temperature		0°C to 40°C (with no freezing)				
	Surrounding Air Humidity		20% to 80% relative humidity (with no condensation)				
	Installation Site		<ul style="list-style-type: none"> • Must be indoors and free of corrosive and explosive gases. • Must be well-ventilated and free of dust and moisture. • Must facilitate inspection and cleaning. • Must have an altitude of 1,000 m or less. • Must be free of strong magnetic fields. 				
	Storage Environment		Store the Servomotor in the following environment if you store it with the power cable disconnected. Storage Temperature: -20°C to 60°C (with no freezing) Storage Humidity: 20% to 80% relative humidity (with no condensation)				
Mechanical Tolerances* ³	Runout of Output Shaft Surface	mm	0.02				
	Runout at End of Output Shaft	mm	0.04				
	Parallelism between Mounting Surface and Output Shaft Surface	mm	-				
	Concentricity between Output Shaft and Flange Outer Diameter	mm	0.08				
	Perpendicularity between Mounting Surface and Output Shaft	mm	0.08				
Shock Resistance* ⁴	Impact Acceleration Rate at Flange		490 m/s ²				
	Number of Impacts		2 times				
Vibration Resistance* ⁴	Vibration Acceleration Rate at Flange		24.5 m/s ²				
Applicable SERVOPACKs	SGD7S-	7R6A	120A	180A	120A	200 A	
	SGD7W-SGD7C-	7R6A	-				

*1. A vibration class of V15 indicates a vibration amplitude of 15 μm maximum on the Servomotor without a load at the rated motor speed.

*2. This does not apply to the shaft opening. Protective structure specifications apply only when the special cable is used.

*3. Refer to the following figure for the relevant locations on the Servomotor. Refer to the dimensional drawings of the individual Servomotors for more information on tolerances.

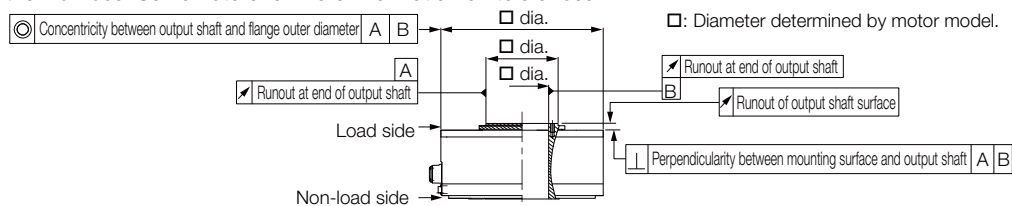

*4. The given values are for when the Servomotor shaft is mounted horizontally and shock or vibration is applied in the directions shown in the following figures.

The strength of the vibration that the Servomotor can withstand depends on the application. Check the vibration acceleration rate.

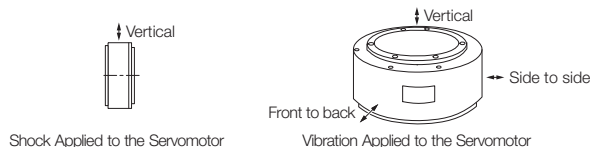

Medium-Capacity Servomotors with Cores: Ratings

Voltage		200 V					
Model SGMCS-		45M	80M	1AM	80N	1EN	2ZN
Rated Output ^{*1}	W	707	1260	1730	1260	2360	3140
Rated Torque ^{*1, *2}	N·m	45.0	80.0	110	80.0	150	200
Instantaneous Maximum Torque ^{*1}	N·m	135	240	330	240	450	600
Stall Torque ^{*1}	N·m	45.0	80.0	110	80.0	150	200
Rated Current ^{*1}	Arms	5.8	9.7	13.4	9.4	17.4	18.9
Instantaneous Maximum Current ^{*1}	Arms	17.0	28.0	42.0	28.0	56.0	56.0
Rated Motor Speed ^{*1}	min ⁻¹	150			150		
Maximum Motor Speed ^{*1}	min ⁻¹	300			300	250	
Torque Constant	N·m/Arms	8.39	8.91	8.45	9.08	9.05	11.5
Motor Moment of Inertia	$\times 10^{-4}$ kg·m ²	388	627	865	1360	2470	3060
Rated Power Rate ^{*1}	kW/s	52.2	102	140	47.1	91.1	131
Rated Angular Acceleration Rate ^{*1}	rad/s ²	1160	1280	1270	588	607	654
Heat Sink Size	mm	750 × 750 × 45					
Allowable Load Moment of Inertia (Motor Moment of Inertia Ratio)		3 times					
With External Regenerative Resistor and External Dynamic Brake Resistor		3 times					
Allowable Load ^{*3}	A	mm	33			37.5	
	Allowable Thrust Load	N	9000			16000	
	Allowable Moment Load	N·m	180			350	

*1. These values are for operation in combination with a SERVOPACK when the temperature of the armature winding is 20°C. These are typical values.

*2. The rated torques are the continuous allowable torque values at a surrounding air temperature of 40°C with a steel heat sink of the dimensions given in the table.

*3. The thrust loads and moment loads that are applied while a Servomotor is operating are roughly classified into the following patterns. Design the machine so that the thrust loads or moment loads will not exceed the values given in the table.

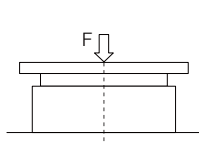

Where F is the external force,
Thrust load = F + Load mass
Moment load = 0

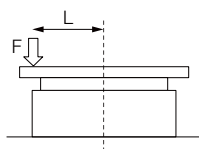

Where F is the external force,
Thrust load = F + Load mass
Moment load = F × L

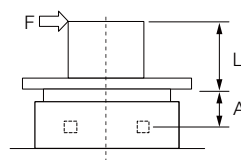

Where F is the external force,
Thrust load = Load mass
Moment load = F × (L + A)

Note: For the bearings used in these Servomotors, the loss depends on the bearing temperature. The amount of heat loss is higher at low temperatures.

Medium-Capacity Servomotors with Cores: Torque-Motor Speed Characteristics

A : Continuous duty zone

B : Intermittent duty zone

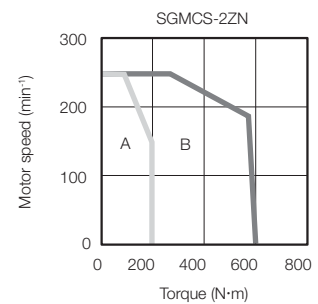
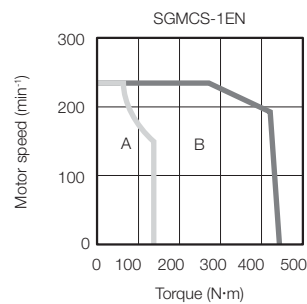
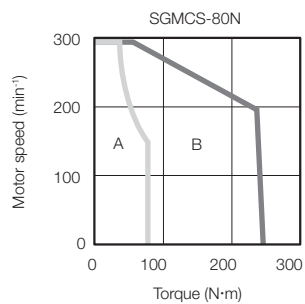
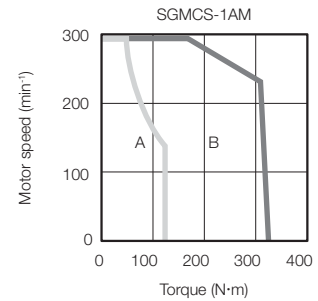
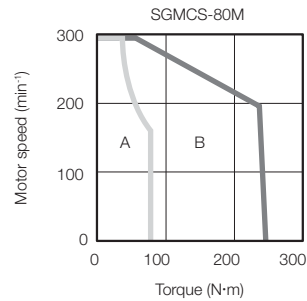
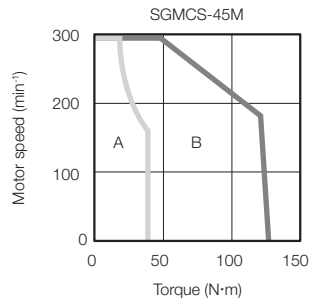

Note: 1. These values (typical values) are for operation in combination with a SERVOPACK when the temperature of the armature winding is 20°C.

2. If the effective torque is within the allowable range for the rated torque, the Servomotor can be used within the intermittent duty zone.

3. If you use a Servomotor Main Circuit Cable that exceeds 20 m, the intermittent duty zone in the torque-motor speed characteristics will become smaller because the voltage drop increases.

Medium-Capacity Servomotors with Cores: Servomotor Overload Protection Characteristics

The overload detection level is set for hot start conditions with a Servomotor surrounding air temperature of 40°C.

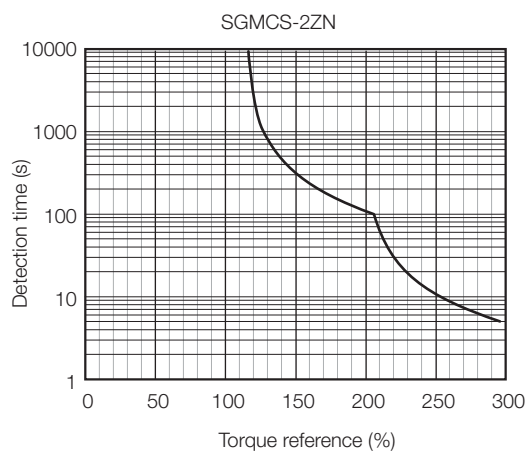
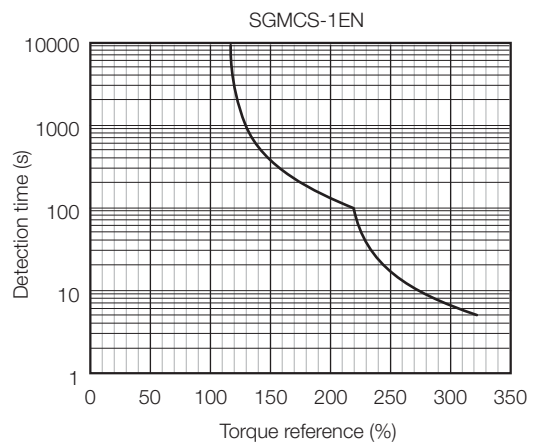
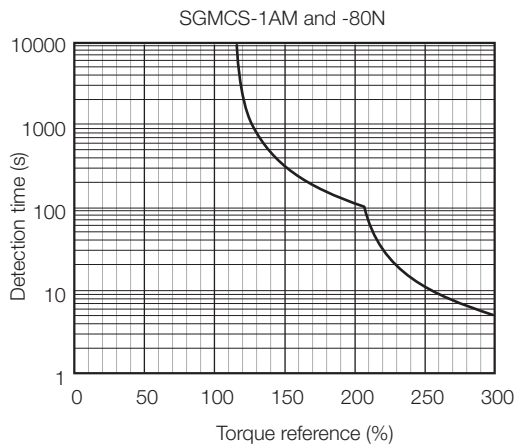
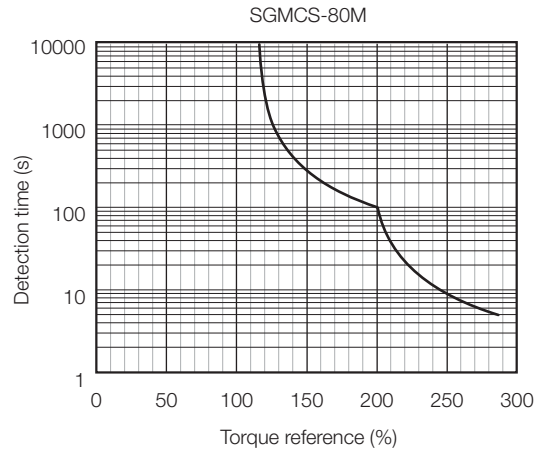
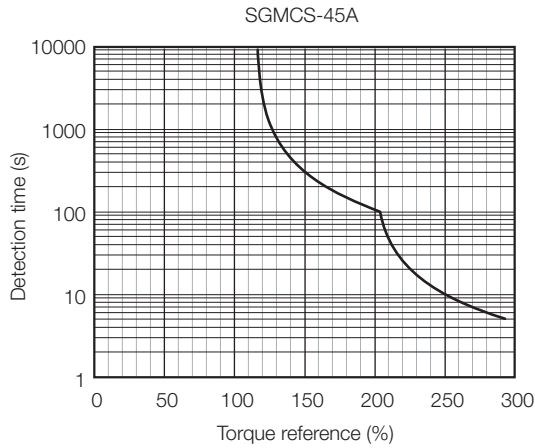

Note: The above overload protection characteristics do not mean that you can perform continuous duty operation with an output of 100% or higher. Use the Servomotor so that the effective torque remains within the continuous duty zone given in *Medium-Capacity Servomotors with Cores: Torque-Motor Speed Characteristics* on page 203.

Allowable Load Moment of Inertia

The allowable load moments of inertia (motor moment of inertia ratios) for the Servomotors are given in the *Small-Capacity, Coreless Servomotors: Ratings* (page 198) and *Medium-Capacity Servomotors with Cores: Ratings* (page 202). The values are determined by the regenerative energy processing capacity of the SERVOPACK and are also affected by the drive conditions of the Servomotor. Perform the required Steps for each of the following cases.

Use the SigmaSize+ AC Servo Drive Capacity Selection Program to check the driving conditions. Contact your Yaskawa representative for information on this program.

◆ Exceeding the Allowable Load Moment of Inertia

Use one of the following measures to adjust the load moment of inertia to within the allowable value.

- Reduce the torque limit.
- Reduce the deceleration rate.
- Reduce the maximum motor speed.

If the above steps is not possible, install an external regenerative resistor.

Information

An Overvoltage Alarm (A.400) is likely to occur during deceleration if the load moment of inertia exceeds the allowable load moment of inertia. SERVOPACKs with a built-in regenerative resistor may generate a Regenerative Overload Alarm (A.320). Refer to *Built-In Regenerative Resistor* (page 472) for the regenerative power (W) that can be processed by the SERVOPACKs.

Install an External Regenerative Resistor when the built-in regenerative resistor cannot process all of the regenerative power.

◆ SERVOPACKs without Built-in Regenerative Resistors

The following graph shows the allowable load moment of inertia scaling factor of the motor speed (reference values for deceleration operation at or above the rated torque). Application is possible without an external regenerative resistor within the allowable value. However, an External Regenerative Resistor is required in the shaded areas of the graphs.

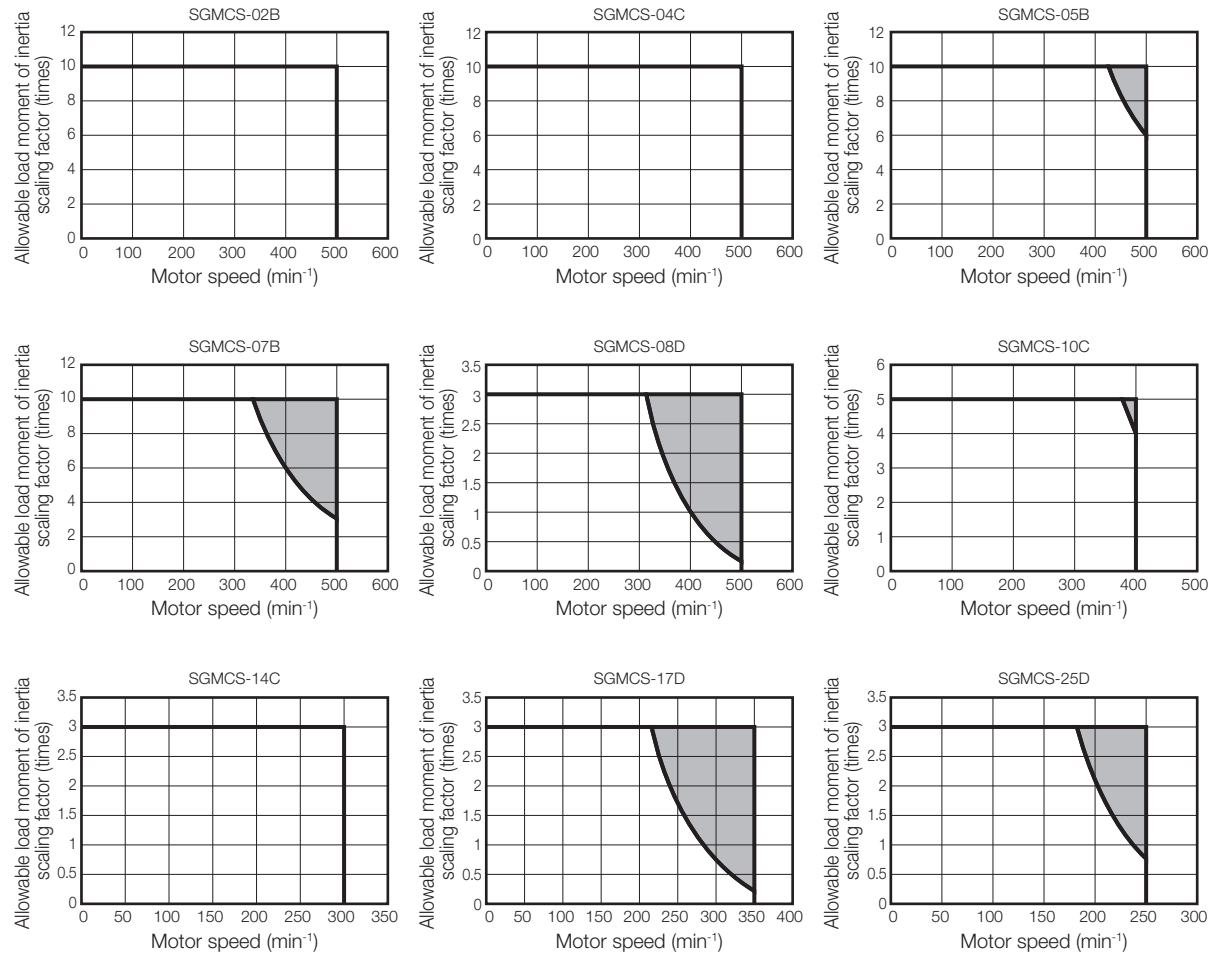

Note: Applicable SERVOPACK models: SGD7S-2R8A and -2R8F

◆ When an External Regenerative Resistor Is Required

Install the External Regenerative Resistor. Refer to the following section for the recommended products.

[External Regenerative Resistors \(page 472\)](#)

External Dimensions

Small-Capacity, Coreless Servomotors

◆ SGMCS-□□B

• Flange Specification 1

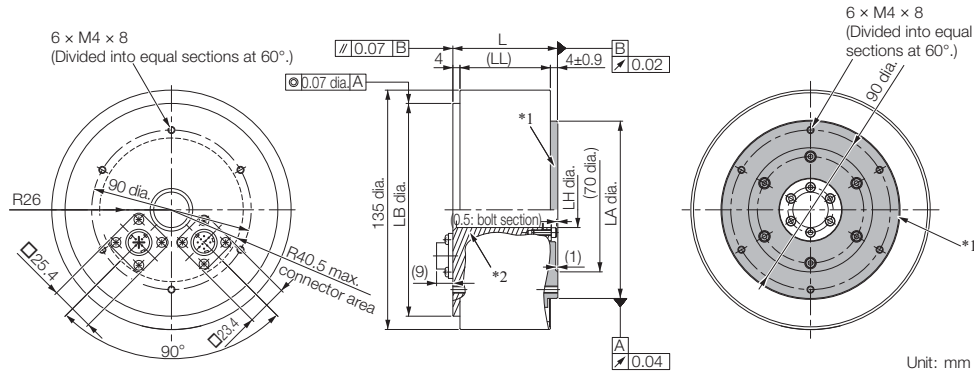

- *1. The shaded section indicates the rotating parts.
 *2. The hatched section indicates the non-rotating parts.
 Note: Values in parentheses are reference dimensions.

Model SGMCS-	L	(LL)	LB	LH	LA	Approx. Mass [kg]
02B□C11	59	51	120 ⁰ _{-0.035}	20 ^{+0.4} ₀	100 ⁰ _{-0.035}	4.8
05B□C11	88	80	120 ⁰ _{-0.035}	20 ^{+0.4} ₀	100 ⁰ _{-0.035}	5.8
07B□C11	128	120	120 ⁰ _{-0.035}	20 ^{+0.4} ₀	100 ⁰ _{-0.035}	8.2

• Flange Specification 4

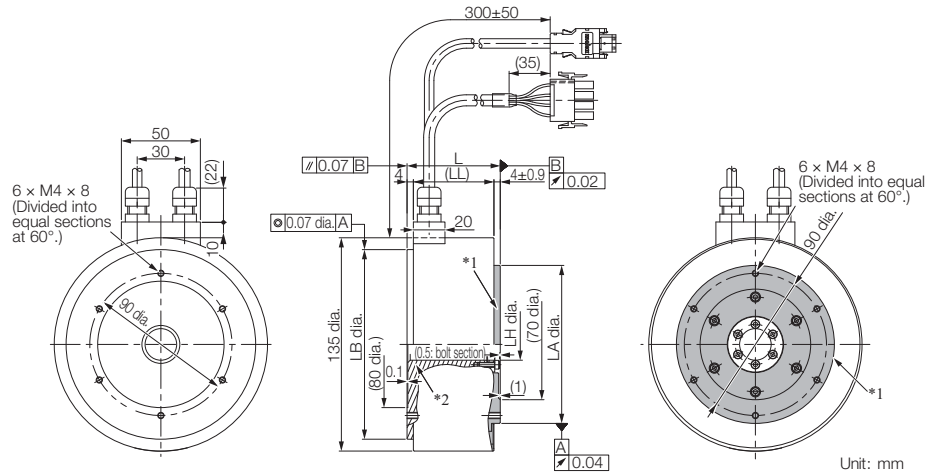

- *1. The shaded section indicates the rotating parts.
 *2. The hatched section indicates the non-rotating parts.
 Note: Values in parentheses are reference dimensions.

Model SGMCS-	L	(LL)	LB	LH	LA	Approx. Mass [kg]
02B□C41	59	51	120 ⁰ _{-0.035}	20 ^{+0.4} ₀	100 ⁰ _{-0.035}	4.8
05B□C41	88	80	120 ⁰ _{-0.035}	20 ^{+0.4} ₀	100 ⁰ _{-0.035}	5.8
07B□C41	128	120	120 ⁰ _{-0.035}	20 ^{+0.4} ₀	100 ⁰ _{-0.035}	8.2

Refer to the following section for information on connectors.

🔌 [Connector Specifications](#) (page 213)

◆ SGMCS-□□C

• Flange Specification 1

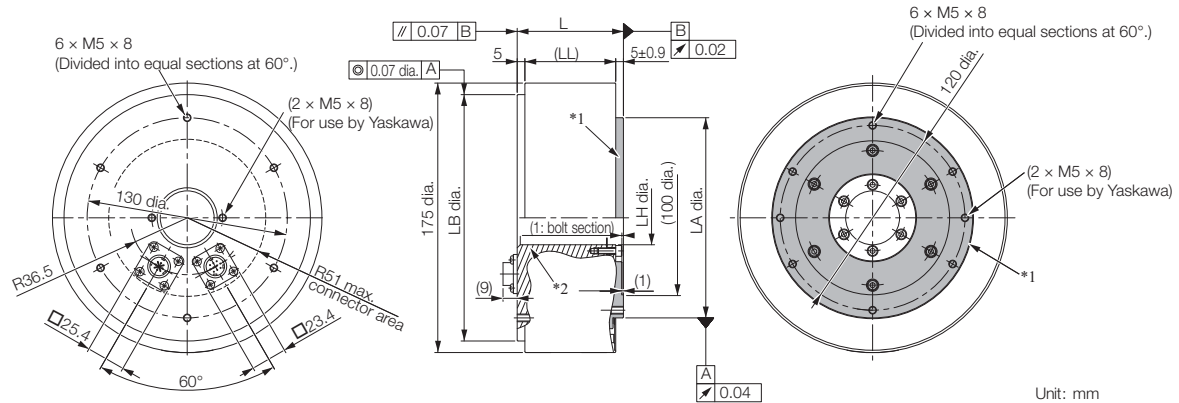

*1. The shaded section indicates the rotating parts.
 *2. The hatched section indicates the non-rotating parts.
 Note: Values in parentheses are reference dimensions.

Model SGMCS-	L	(LL)	LB	LH	LA	Approx. Mass [kg]
04C□□C11	69	59	160 ⁰ _{-0.040}	35 ^{+0.4} ₀	130 ⁰ _{-0.040}	7.2
10C□□C11	90	80	160 ⁰ _{-0.040}	35 ^{+0.4} ₀	130 ⁰ _{-0.040}	10.2
14C□□C11	130	120	160 ⁰ _{-0.040}	35 ^{+0.4} ₀	130 ⁰ _{-0.040}	14.2

• Flange Specification 4

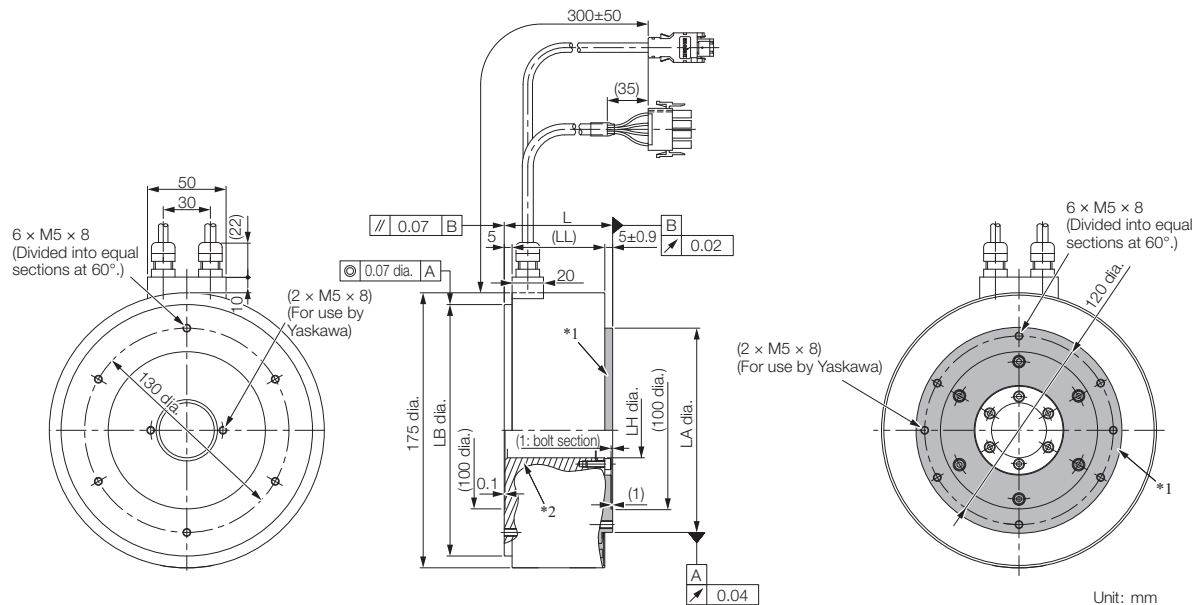

*1. The shaded section indicates the rotating parts.
 *2. The hatched section indicates the non-rotating parts.
 Note: Values in parentheses are reference dimensions.

Model SGMCS-	L	(LL)	LB	LH	LA	Approx. Mass [kg]
04C□□C41	69	59	160 ⁰ _{-0.040}	35 ^{+0.4} ₀	130 ⁰ _{-0.040}	7.2
10C□□C41	90	80	160 ⁰ _{-0.040}	35 ^{+0.4} ₀	130 ⁰ _{-0.040}	10.2
14C□□C41	130	120	160 ⁰ _{-0.040}	35 ^{+0.4} ₀	130 ⁰ _{-0.040}	14.2

Refer to the following section for information on connectors.

☞ Connector Specifications (page 213)

◆ SGMCS-□□□

• Flange Specification 1

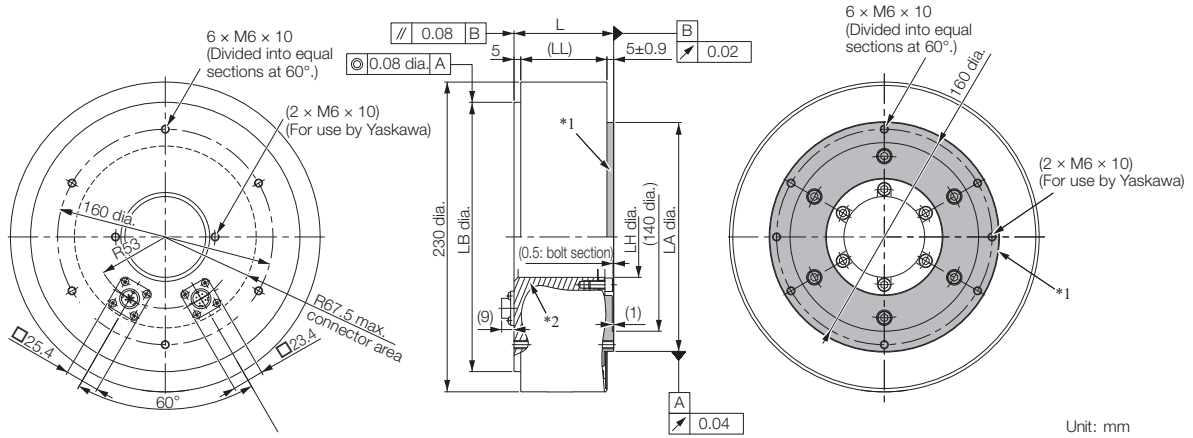

- *1. The shaded section indicates the rotating parts.
 - *2. The hatched section indicates the non-rotating parts.
- Note: Values in parentheses are reference dimensions.

Model SGMCS-	L	(LL)	LB	LH	LA	Approx. Mass [kg]
08D□C11	74	64	200 ⁰ _{-0.046}	60 ^{+0.4} ₀	170 ⁰ _{-0.040}	14.0
17D□C11	110	100	200 ⁰ _{-0.046}	60 ^{+0.4} ₀	170 ⁰ _{-0.040}	22.0
25D□C11	160	150	200 ⁰ _{-0.046}	60 ^{+0.4} ₀	170 ⁰ _{-0.040}	29.7

• Flange Specification 4

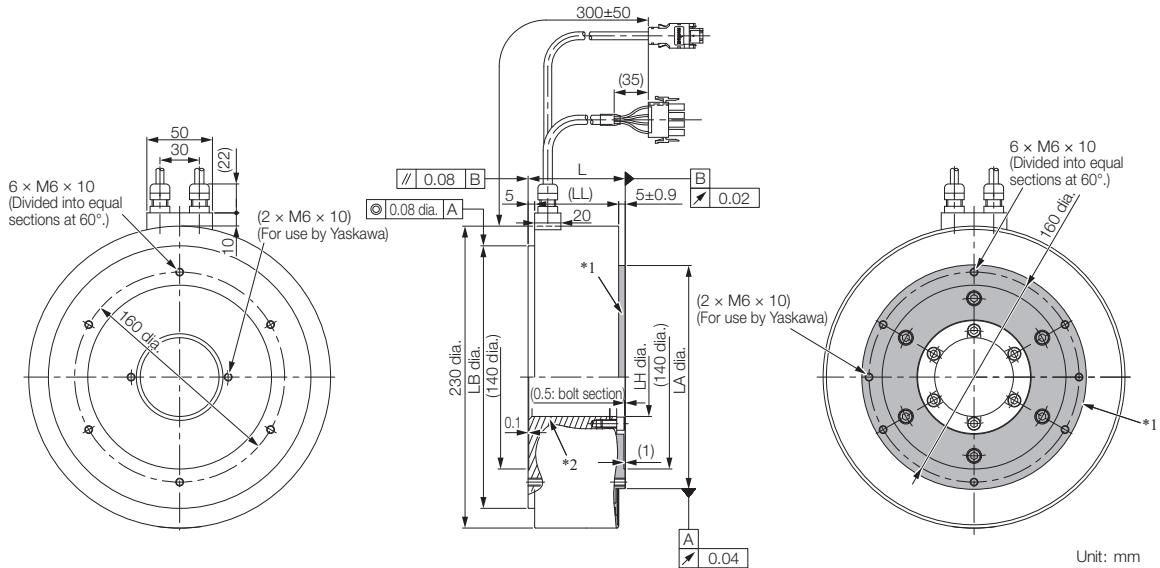

- *1. The shaded section indicates the rotating parts.
 - *2. The hatched section indicates the non-rotating parts.
- Note: Values in parentheses are reference dimensions.

Model SGMCS-	L	(LL)	LB	LH	LA	Approx. Mass [kg]
08D□C41	74	64	200 ⁰ _{-0.046}	60 ^{+0.4} ₀	170 ⁰ _{-0.040}	14.0
17D□C41	110	100	200 ⁰ _{-0.046}	60 ^{+0.4} ₀	170 ⁰ _{-0.040}	22.0
25D□C41	160	150	200 ⁰ _{-0.046}	60 ^{+0.4} ₀	170 ⁰ _{-0.040}	29.7

Refer to the following section for information on connectors.

☞ Connector Specifications (page 213)

◆ SGMCS-□□E

• Flange Specification 1

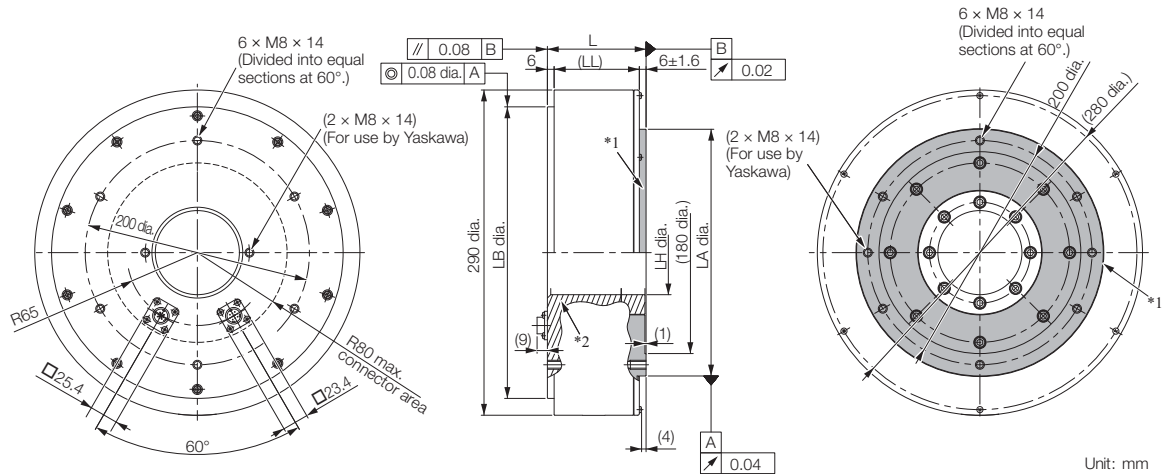

*1. The shaded section indicates the rotating parts.
 *2. The hatched section indicates the non-rotating parts.
 Note: Values in parentheses are reference dimensions.

Model SGMCS-	L	(LL)	LB	LH	LA	Approx. Mass [kg]
16E□B11	88	76	260 ⁰ _{-0.052}	75 ^{+0.4} ₀	220 ⁰ _{-0.046}	26.0
35E□B11	112	100	260 ⁰ _{-0.052}	75 ^{+0.4} ₀	220 ⁰ _{-0.046}	34.0

• Flange Specification 4

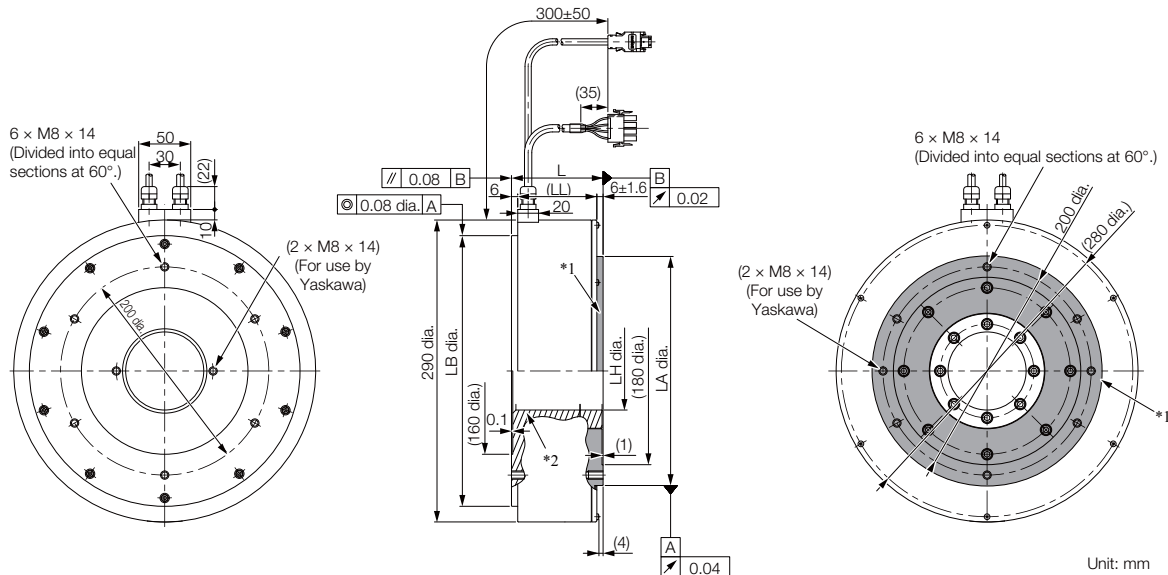

*1. The shaded section indicates the rotating parts.
 *2. The hatched section indicates the non-rotating parts.
 Note: Values in parentheses are reference dimensions.

Model SGMCS-	L	(LL)	LB	LH	LA	Approx. Mass [kg]
16E□B41	88	76	260 ⁰ _{-0.052}	75 ^{+0.4} ₀	220 ⁰ _{-0.046}	26.0
35E□B41	112	100	260 ⁰ _{-0.052}	75 ^{+0.4} ₀	220 ⁰ _{-0.046}	34.0

Refer to the following section for information on connectors.

📖 Connector Specifications (page 213)

Medium-Capacity Servomotors with Cores

◆ SGMCS-□□M

• Flange Specification 1

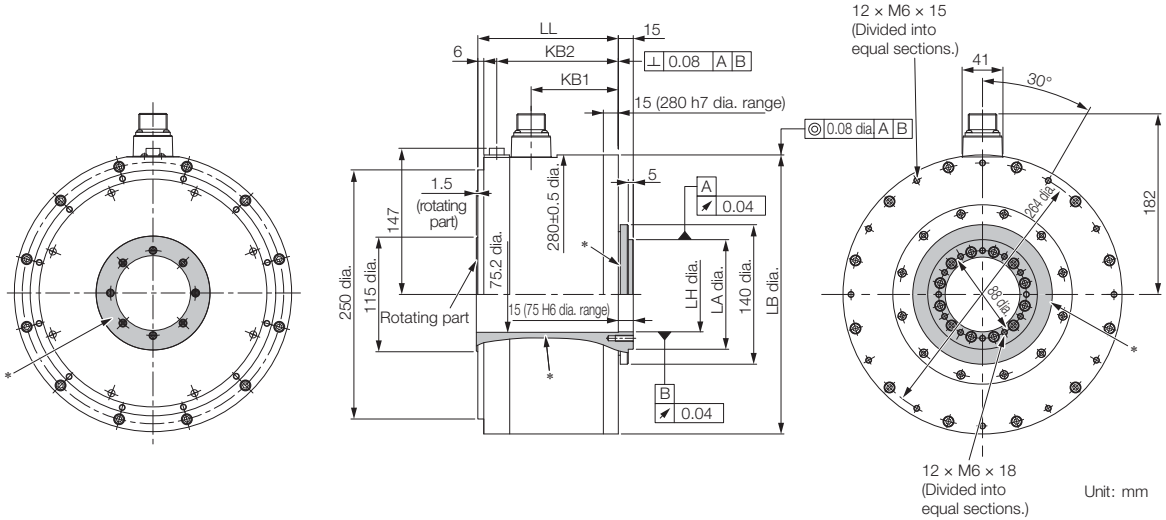

* The shaded section indicates the rotating parts.

Model SGMCS-	LL	KB1	KB2	LB	LH	LA	Approx. Mass [kg]
45M□A11	141	87.5	122	280 ⁰ _{-0.052}	75 ^{+0.019} ₀	110 ⁰ _{-0.035}	38
80M□A11	191	137.5	172	280 ⁰ _{-0.052}	75 ^{+0.019} ₀	110 ⁰ _{-0.035}	45
1AM□A11	241	187.5	222	280 ⁰ _{-0.052}	75 ^{+0.019} ₀	110 ⁰ _{-0.035}	51

• Flange Specification 3

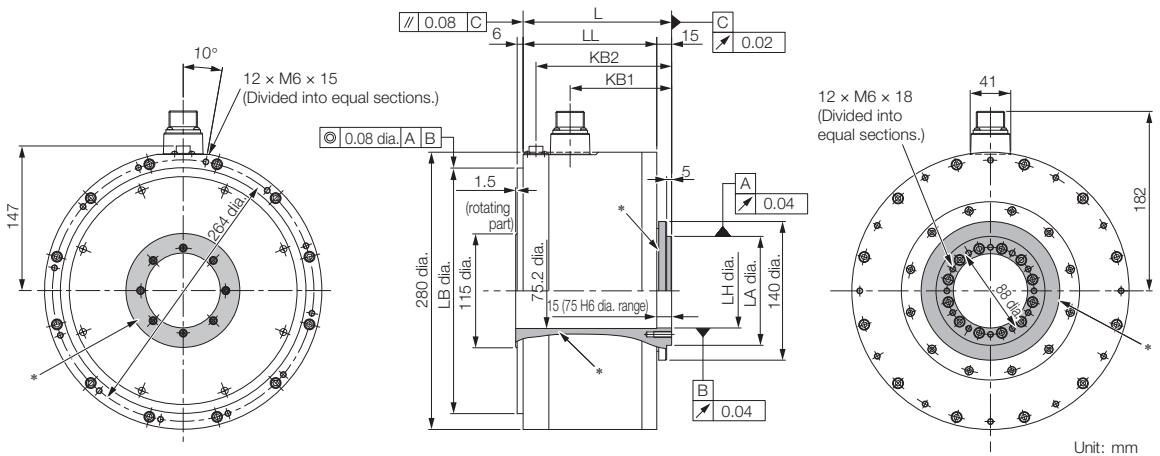

* The shaded section indicates the rotating parts.

Model SGMCS-	L	LL	KB1	KB2	LB	LH	LA	Approx. Mass [kg]
45M□A31	150	135	102.5	137	248 ⁰ _{-0.046}	75 ^{+0.019} ₀	110 ⁰ _{-0.035}	38
80M□A31	200	185	152.5	187	248 ⁰ _{-0.046}	75 ^{+0.019} ₀	110 ⁰ _{-0.035}	45
1AM□A31	250	235	202.5	237	248 ⁰ _{-0.046}	75 ^{+0.019} ₀	110 ⁰ _{-0.035}	51

Refer to the following section for information on connectors.

Connector Specifications (page 213)

◆ SGMCS-□□□

• Flange Specification 1

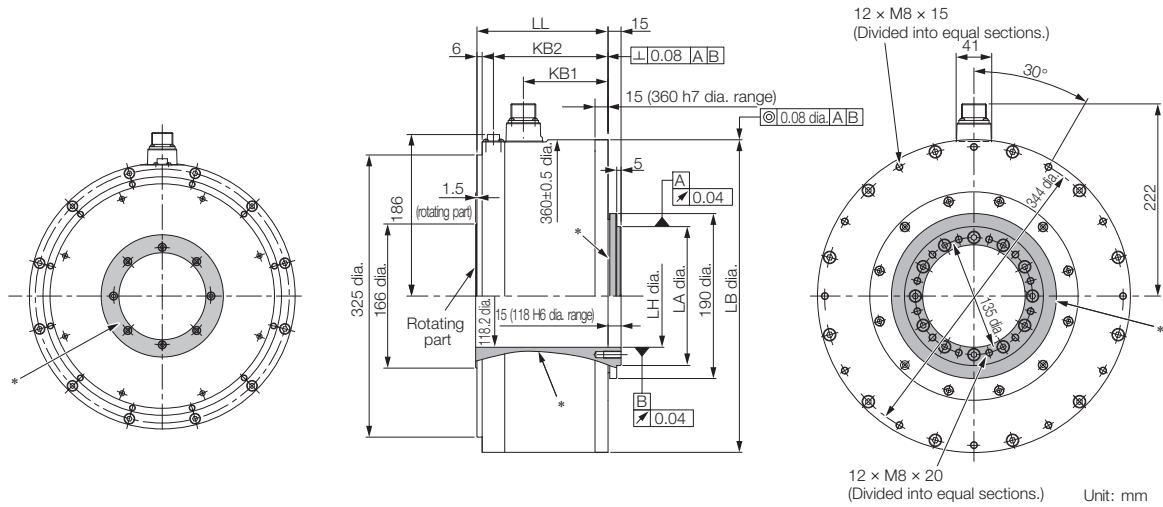

* The shaded section indicates the rotating parts.

Model SGMCS-	LL	KB1	KB2	LB	LH	LA	Approx. Mass [kg]
80N□A11	151	98	132	360 ⁰ _{-0.057}	118 ^{+0.022} ₀	160 ⁰ _{-0.040}	50
1EN□A11	201	148	182	360 ⁰ _{-0.057}	118 ^{+0.022} ₀	160 ⁰ _{-0.040}	68
2ZN□A11	251	198	232	360 ⁰ _{-0.057}	118 ^{+0.022} ₀	160 ⁰ _{-0.040}	86

• Flange Specification 3

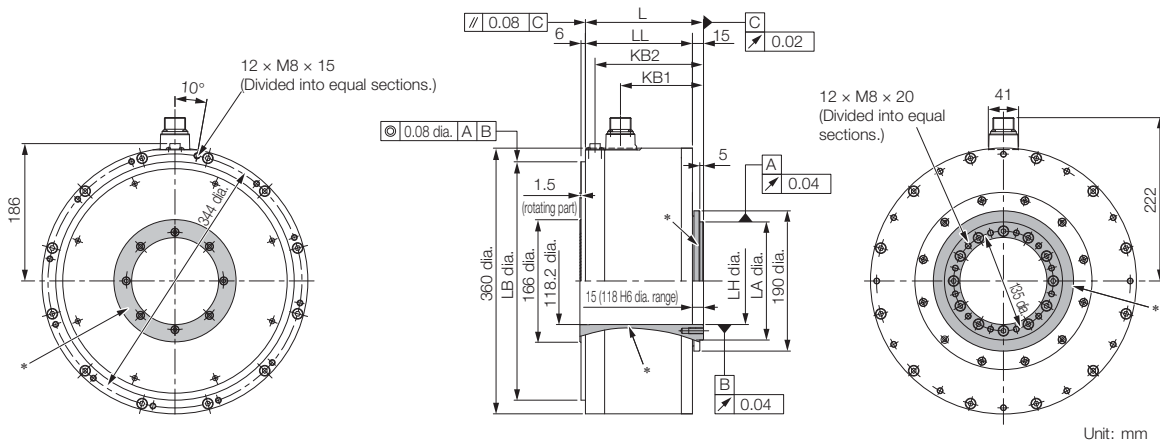

* The shaded section indicates the rotating parts.

Model SGMCS-	L	LL	KB1	KB2	LB	LH	LA	Approx. Mass [kg]
80N□A31	160	145	113	147	323 ⁰ _{-0.057}	118 ^{+0.022} ₀	160 ⁰ _{-0.040}	50
1EN□A31	210	195	163	197	323 ⁰ _{-0.057}	118 ^{+0.022} ₀	160 ⁰ _{-0.040}	68
2ZN□A31	260	245	213	247	323 ⁰ _{-0.057}	118 ^{+0.022} ₀	160 ⁰ _{-0.040}	86

Refer to the following section for information on connectors.

🔗 Connector Specifications (page 213)

Connector Specifications

◆ SGMCS-□□B, -□□C, -□□D, or -□□E with Flange Specification 1

• Servomotor Connector

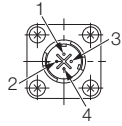

1	Phase U
2	Phase V
3	Phase W
4	FG (frame ground)

Model: JN1AS04MK2R
 Manufacturer: Japan Aviation Electronics Industry, Ltd.

Mating connector: JN1DS04FK1
 (Not provided by Yaskawa.)

• Encoder Connector

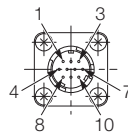

1	PS
2	/PS
3	-
4	PG5V
5	-
6	-
7	FG (frame ground)
8	-
9	PG0V
10	-

Model: JN1AS10ML1-R
 Manufacturer: Japan Aviation Electronics Industry, Ltd.

Mating connector: JN1DS10SL1
 (Not provided by Yaskawa.)

◆ SGMCS-□□B, -□□C, -□□D, or -□□E with Flange Specification 4

• Servomotor Connector

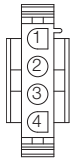

1	Phase U	Red
2	Phase V	White
3	Phase W	Blue
4	FG (frame ground)	Green (yellow)

Models

- Plug: 350779-1
- Pins: 350561-3 or 350690-3 (No.1 to 3)
- Ground pin: 350654-1 or 350669-1 (No. 4)
- Manufacturer: Tyco Electronics Japan G.K.

Mating Connector

- Cap: 350780-1
- Socket: 350570-3 or 350689-3

• Encoder Connector

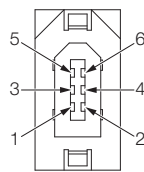

1	PG5V
2	PG0V
3	-
4	-
5	PS
6	/PS
Connector case	FG (frame ground)

Model: 55102-0600
 Manufacturer: Molex Japan LLC

Mating connector: 54280-0609

◆ SGMCS-□□M or -□□N with Flange Specification 1 or 3

• Servomotor Connector

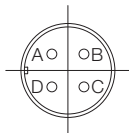

A	Phase U
B	Phase V
C	Phase W
D	FG (frame ground)

Model: CE05-2A18-10PD
 Manufacturer: DDK Ltd.

Mating Connector

Plug: CE05-6A18-10SD-B-BSS
 Cable clamp: CE3057-10A-□(D265)

• Encoder Connector

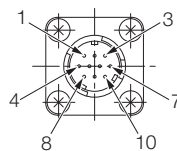

1	PS
2	/PS
3	-
4	PG5V
5	-
6	-
7	FG (frame ground)
8	-
9	PG0V
10	-

Model: JN1AS10ML1
 Manufacturer: Japan Aviation Electronics Industry, Ltd.

Mating connector:
 JN1DS10SL1

Selecting Cables

◆ Cable Configurations

The cables shown below are required to connect a Servomotor to a SERVOPACK.

Encoder Cable of 20 m or Less

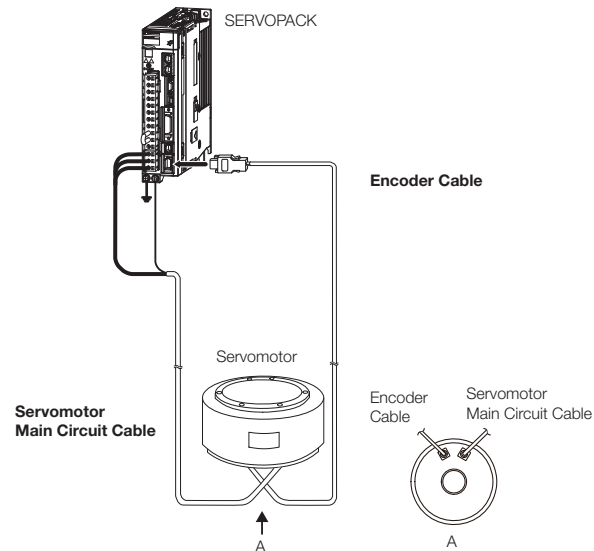

Encoder Cable of 30 m to 50 m (Relay Cable)

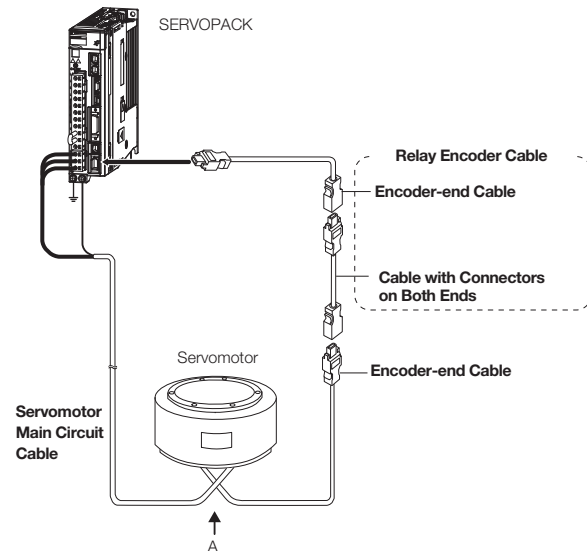

Note: 1. If the Encoder Cable length exceeds 20 m, be sure to use a Relay Encoder Cable.

2. If you use a Servomotor Main Circuit Cable that exceeds 20 m, the intermittent duty zone in the torque-motor speed characteristics will become smaller because the voltage drop increases.

3. Refer to the following manual for the following information.

- Cable dimensional drawings and cable connection specifications
- Order numbers and specifications of individual connectors for cables
- Order numbers and specifications for wiring materials

☞ *Σ-7-Series AC Servo Drive Peripheral Device Selection Manual (Manual No.: SIEP S800001 32)*

◆ Servomotor Main Circuit Cables

Servomotor Model	Length (L)	Order Number		Appearance
		Standard Cable	Flexible Cable*1	
SGMCS-□□B SGMCS-□□C SGMCS-□□D SGMCS-□□E Flange specification*2: 1 Non-load side installation	3 m	JZSP-CMM60-03-E	JZSP-CSM60-03-E	
	5 m	JZSP-CMM60-05-E	JZSP-CSM60-05-E	
	10 m	JZSP-CMM60-10-E	JZSP-CSM60-10-E	
	15 m	JZSP-CMM60-15-E	JZSP-CSM60-15-E	
	20 m	JZSP-CMM60-20-E	JZSP-CSM60-20-E	
SGMCS-□□B SGMCS-□□C SGMCS-□□D SGMCS-□□E Flange specification*2: 4 Non-load side installation (with cable on side)	3 m	JZSP-CMM00-03-E	JZSP-CMM01-03-E	
	5 m	JZSP-CMM00-05-E	JZSP-CMM01-05-E	
	10 m	JZSP-CMM00-10-E	JZSP-CMM01-10-E	
	15 m	JZSP-CMM00-15-E	JZSP-CMM01-15-E	
	20 m	JZSP-CMM00-20-E	JZSP-CMM01-20-E	

Continued on next page.

Continued from previous page.

Servomotor Model	Length (L)	Order Number		Appearance	
		Standard Cable	Flexible Cable*1		
SGMCS-□□M SGMCS-□□N □□: 45 □□: 80	3 m	JZSP-USA101-03-E	JZSP-USA121-03-E		
	5 m	JZSP-USA101-05-E	JZSP-USA121-05-E		
	10 m	JZSP-USA101-10-E	JZSP-USA121-10-E		
	15 m	JZSP-USA101-15-E	JZSP-USA121-15-E		
	20 m	JZSP-USA101-20-E	JZSP-USA121-20-E		
	3 m	3 m	JZSP-USA102-03-E	JZSP-USA122-03-E	
		5 m	JZSP-USA102-05-E	JZSP-USA122-05-E	
		10 m	JZSP-USA102-10-E	JZSP-USA122-10-E	
		15 m	JZSP-USA102-15-E	JZSP-USA122-15-E	
		20 m	JZSP-USA102-20-E	JZSP-USA122-20-E	
SGMCS-□□M SGMCS-□□N □□: 1A	3 m	JZSP-USA301-03-E	JZSP-USA321-03-E		
	5 m	JZSP-USA301-05-E	JZSP-USA321-05-E		
	10 m	JZSP-USA301-10-E	JZSP-USA321-10-E		
	15 m	JZSP-USA301-15-E	JZSP-USA321-15-E		
	20 m	JZSP-USA301-20-E	JZSP-USA321-20-E		
	3 m	3 m	JZSP-USA302-03-E	JZSP-USA322-03-E	
		5 m	JZSP-USA302-05-E	JZSP-USA322-05-E	
		10 m	JZSP-USA302-10-E	JZSP-USA322-10-E	
		15 m	JZSP-USA302-15-E	JZSP-USA322-15-E	
		20 m	JZSP-USA302-20-E	JZSP-USA322-20-E	
SGMCS-□□M SGMCS-□□N □□: 1E □□: 2Z	3 m	JZSP-USA501-03-E	JZSP-USA521-03-E		
	5 m	JZSP-USA501-05-E	JZSP-USA521-05-E		
	10 m	JZSP-USA501-10-E	JZSP-USA521-10-E		
	15 m	JZSP-USA501-15-E	JZSP-USA521-15-E		
	20 m	JZSP-USA501-20-E	JZSP-USA521-20-E		
	3 m	3 m	JZSP-USA502-03-E	JZSP-USA522-03-E	
		5 m	JZSP-USA502-05-E	JZSP-USA522-05-E	
		10 m	JZSP-USA502-10-E	JZSP-USA522-10-E	
		15 m	JZSP-USA502-15-E	JZSP-USA522-15-E	
		20 m	JZSP-USA502-20-E	JZSP-USA522-20-E	

*1. Use Flexible Cables for moving parts of machines, such as robots. The recommended bending radius of the Flexible Cables are given in the following table.

Order Number	Recommended Bending Radius (R)	Order Number	Recommended Bending Radius (R)
JZSP-CSM60-□□-E	55 mm min.	JZSP-USA321-□□-E	113 mm min.
JZSP-CMN01-□□-E		JZSP-USA322-□□-E	
JZSP-USA121-□□-E	96 mm min.	JZSP-USA521-□□-E	150 mm min.
JZSP-USA122-□□-E		JZSP-USA522-□□-E	

*2. Refer to the following section for the flange specifications.

Model Designations (page 196)

Note: Direct Drive Servomotors are not available with holding brakes.

◆ Encoder Cables of 20 m or Less

Servomotor Model	Name	Length (L)	Order Number		Appearance
			Standard Cable	Flexible Cable*1	
SGMCS-□□ Flange specification*2: 1 or 3	For incremental/absolute encoder	3 m	JZSP-CMP60-03-E	JZSP-CSP60-03-E	
		5 m	JZSP-CMP60-05-E	JZSP-CSP60-05-E	
		10 m	JZSP-CMP60-10-E	JZSP-CSP60-10-E	
		15 m	JZSP-CMP60-15-E	JZSP-CSP60-15-E	
		20 m	JZSP-CMP60-20-E	JZSP-CSP60-20-E	
SGMCS-□□ Flange Specification*2: 4	For incremental/absolute encoder	3 m	JZSP-CMP00-03-E	JZSP-CMP10-03-E	
		5 m	JZSP-CMP00-05-E	JZSP-CMP10-05-E	
		10 m	JZSP-CMP00-10-E	JZSP-CMP10-10-E	
		15 m	JZSP-CMP00-15-E	JZSP-CMP10-15-E	
		20 m	JZSP-CMP00-20-E	JZSP-CMP10-20-E	

*1. Use Flexible Cables for moving parts of machines, such as robots. The recommended bending radius (R) is 68 mm or larger.

*2. Refer to the following section for the flange specifications.

Model Designations (page 196)

◆ Relay Encoder Cables of 30 m to 50 m

Servomotor Model	Name	Length (L)	Order Number*1	Appearance
SGMCS-□□ Flange specification*2: 1 or 3	Encoder-end Cable (for incremental or absolute encoder)	0.3 m	JZSP-CSP15-E	
SGMCS-□□ Flange specification*2: 1, 3, or 4	Cables with Connectors on Both Ends (for incremental or absolute encoder)	30 m	JZSP-UCMP00-30-E	
		40 m	JZSP-UCMP00-40-E	
		50 m	JZSP-UCMP00-50-E	

*1. Flexible Cables are not available.

*2. Refer to the following section for the flange specifications.

Model Designations (page 196)

Linear Servomotors

■ Features



SGLG (Coreless Models) 218

- Lack of magnetic attraction force helps extend the life of linear motion guides and minimizes noise.
- Zero cogging for minimal force ripple.

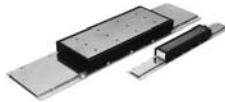

SGLF (Models with F-type Iron Cores) 242

- Large magnetic attraction force between the moving and stationary members can be used to effectively increase rigidity by preloading the linear guide.
- Magnetic preloading on the linear guide can help increase the system's frequency response, improving its damping and settling performances.



SGLT (Models with T-type Iron Cores) 282

- Negates the effects of the magnetic attraction force between the relative motor members.
- Very little cogging.

Common

Recommended Linear Encoders and Cables .. 308

SGLG

SGLF

SGLT

Recommended Linear Encoders and Cables

SGLG (Coreless Models)

Model Designations

Moving Coil



1st digit Servomotor Type

Code	Specification
G	Coreless model

2nd digit Moving Coil/Magnetic Way

Code	Specification
W	Moving Coil

3rd+4th digits Magnet Height

Code	Specification
30	30 mm
40	40 mm
60	60 mm
90	86 mm

5th digit Power Supply Voltage

Code	Specification
A	200 VAC

6th+7th+8th digits Length of Moving Coil

Code	Specification
050	50 mm
080	80 mm
140	140 mm
200	199 mm
253	252.5 mm
365	365 mm
370	367 mm
535	535 mm

10th digit Sensor Specification and Cooling Method

Code	Specifications		Applicable Models
	Polarity Sensor	Cooling Method	
None	None	Self-cooled	All models
C	None	Air-cooled	SGLGW -40A, -60A, -90A
H	Yes	Air-cooled	
P	Yes	Self-cooled	All models

11th digit Connector for Servomotor Main Circuit Cable

Code	Specification	Applicable Models
None	Connector from Tyco Electronics Japan G.K.	All models
D	Connector from Interconnectron GmbH	SGLGW -30A, -40A, -60A

9th digit Design Revision Order

A, B...

Note: This information is provided to explain model numbers. It is not meant to imply that models are available for all combinations of codes.

Magnetic Way



1st digit Servomotor Type

(Same as for the Moving Coil.)

2nd digit Moving Coil/Magnetic Way

Code	Specification
M	Magnetic Way

3rd+4th digits Magnet Height

(Same as for the Moving Coil.)

5th+6th+7th digits Length of Magnetic Way

Code	Specification
090	90 mm
108	108 mm
216	216 mm
225	225 mm
252	252 mm
360	360 mm
405	405 mm
432	432 mm
450	450 mm
504	504 mm

9th digit Options

Code	Specification	Applicable Models
None	Standard-force	All models
-M	High-force	SGLGM-40, -60

8th digit Design Revision Order

A, B, C*...

* The SGLGM-40 and SGLGM-60 also have a CT code.

- C = Without mounting holes on the bottom
- CT = With mounting holes on the bottom

Note: This information is provided to explain model numbers. It is not meant to imply that models are available for all combinations of codes.

Precautions on Moving Coils with Polarity Sensors



Note

When you use a Moving Coil with a Polarity Sensor, the Magnetic Way must cover the bottom of the polarity sensor. Refer to the example that shows the correct installation. When determining the length of the Moving Coil's stroke or the length of the Magnetic Way, consider the total length (L) of the Moving Coil and the polarity sensor. Refer to the following table.

Correct Installation

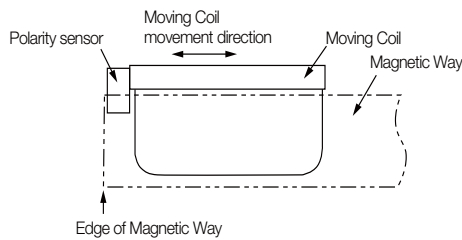

Incorrect Installation

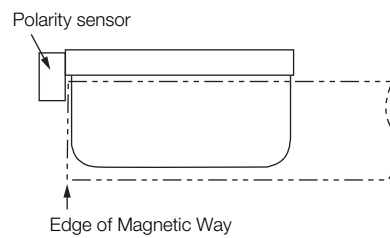

◆ Total Length of Moving Coil with Polarity Sensor

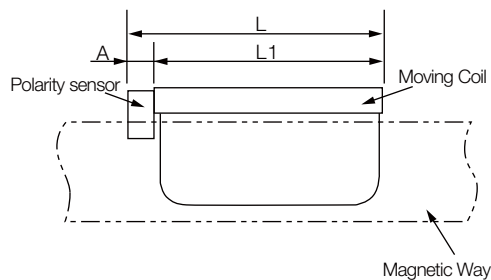

Moving Coil Model SGLGW-	Length of Moving Coil, L1 [mm]	Length of Polarity Sensor, A [mm]	Total Length, L [mm]
30A050□P□	50	0	50
30A080□P□	80	(Included in the length of Moving Coil.)	80
40A140□H□ 40A140□P□	140	16	156
40A253□H□ 40A253□P□	252.5		268.5
40A365□H□ 40A365□P□	365		381
60A140□H□ 60A140□P□	140	16	156
60A253□H□ 60A253□P□	252.5		268.5
60A365□H□ 60A365□P□	365		381
90A200□H□ 90A200□P□	199	0	199
90A370□H□ 90A370□P□	367	(Included in the length of Moving Coil.)	367
90A535□H□ 90A535□P□	535		535

Specifications and Ratings

Specifications: With Standard-Force Magnetic Way

Linear Servomotor Moving Coil Model SGLGW-		30A		40A			60A			90A		
		050C	080C	140C	253C	365C	140C	253C	365C	200C	370C	535C
Time Rating		Continuous										
Thermal Class		B										
Insulation Resistance		500 VDC, 10 M Ω min.										
Withstand Voltage		1,500 VAC for 1 minute										
Excitation		Permanent magnet										
Cooling Method		Self-cooled or air-cooled (Only self-cooled models are available for the SGLGW-30A.)										
Protective Structure		IP00										
Environmental Conditions	Surround- ing Air Tem- perature	0°C to 40°C (with no freezing)										
	Surround- ing Air Humidity	20% to 80% relative humidity (with no condensation)										
	Installation Site	<ul style="list-style-type: none"> • Must be indoors and free of corrosive and explosive gases. • Must be well-ventilated and free of dust and moisture. • Must facilitate inspection and cleaning. • Must have an altitude of 1,000 m or less. • Must be free of strong magnetic fields. 										
Shock Resis- tance	Impact Accelera- tion Rate	196 m/s ²										
	Number of Impacts	2 times										
Vibra- tion Resis- tance	Vibration Accelera- tion Rate	49 m/s ² (the vibration resistance in three directions, vertical, side-to-side, and front-to-back)										

Ratings: With Standard-Force Magnetic Way

Linear Servomotor Moving Coil Model SGLGW-		30A		40A			60A			90A		
		050C	080C	140C	253C	365C	140C	253C	365C	200C	370C	535C
Rated Motor Speed (Reference Speed during Speed Control)*1	m/s	1.5	1.5	2.0	2.0	2.0	2.3	2.3	2.3	1.8	1.5	1.5
Maximum Speed*1	m/s	5.0	5.0	5.0	5.0	5.0	4.8	4.8	4.8	4.0	4.0	4.0
Rated Force*1, *2	N	12.5	25	47	93	140	70	140	210	325	550	750
Maximum Force*1	N	40	80	140	280	420	220	440	660	1300	2200	3000
Rated Current*1	Arms	0.51	0.79	0.80	1.6	2.4	1.2	2.2	3.3	4.4	7.5	10.2
Maximum Current*1	Arms	1.6	2.5	2.4	4.9	7.3	3.5	7.0	10.5	17.6	30.0	40.8
Moving Coil Mass	kg	0.10	0.15	0.34	0.60	0.87	0.42	0.76	1.1	2.2	3.6	4.9
Force Constant	N/Arms	26.4	33.9	61.5	61.5	61.5	66.6	66.6	66.6	78.0	78.0	78.0
BEMF Constant	Vrms/ (m/s)/ phase	8.80	11.3	20.5	20.5	20.5	22.2	22.2	22.2	26.0	26.0	26.0
Motor Constant	N/√W	3.66	5.63	7.79	11.0	13.5	11.1	15.7	19.2	26.0	36.8	45.0
Electrical Time Constant	ms	0.19	0.41	0.43	0.43	0.43	0.45	0.45	0.45	1.4	1.4	1.4
Mechanical Time Constant	ms	7.5	4.7	5.6	5.0	4.8	3.4	3.1	3.0	3.3	2.7	2.4
Thermal Resistance (with Heat Sink)	K/W	5.19	3.11	1.67	0.87	0.58	1.56	0.77	0.51	0.39	0.26	0.22
Thermal Resistance (without Heat Sink)	K/W	8.13	6.32	3.02	1.80	1.23	2.59	1.48	1.15	1.09	0.63	0.47
Magnetic Attraction	N	0	0	0	0	0	0	0	0	0	0	0
Maximum Allowable Payload	kg	1.7	3.4	5.9	12	18	9.9	19	48	110	190	260
Maximum Allowable Payload (With External Regenerative Resistor and External Dynamic Brake Resistor*3)	kg	1.7	3.4	5.9	12	18	9.9	19	48	110	190	260
Combined Magnetic Way, SGLGM-		30□□□A		40□□□□□			60□□□□□			90□□□□A		
Combined Serial Converter Unit, JZDP-□□□□-		250	251	252	253	254	258	259	260	264	265	266
Applicable SERVOPACKs	SGD7S-	R70A, R70F	R90A, R90F		1R6A, 2R1F	2R8A, 2R8F	1R6A, 2R1F	2R8A, 2R8F	5R5A	120A	180A	200A
	SGD7W-SGD7C-	1R6A			2R8A	1R6A	2R8A	5R5A	-			

*1. These values are for operation in combination with a SERVOPACK when the temperature of the armature winding is 100°C. The values for other items are at 20°C. These are typical values.

*2. The rated forces are the continuous allowable force values at a surrounding air temperature of 40°C with an aluminum heat sink of the dimensions given in the following table.

- Heat Sink Dimensions
 - 200 mm × 300 mm × 12 mm: SGLGW-30A050C, -30A080C, -40A140C, and -60A140C
 - 300 mm × 400 mm × 12 mm: SGLGW-40A253C and -60A253C
 - 400 mm × 500 mm × 12 mm: SGLGW-40A365C and -60A365C
 - 800 mm × 900 mm × 12 mm: SGLGW-90A200C, -90A370C, and -90A535C

*3. To externally connect dynamic brake resistor, select hardware option specification 020 for the SERVOPACK. However, you cannot externally connect dynamic brake resistor if you use the following SERVOPACKs (maximum applicable motor capacity: 400 W).

- SGD7S-R70□□□□A020 to -2R8□□□□A020
- SGD7W-1R6A20A020 to -2R8A20A020
- SGD7C-1R6AMAA020 to -2R8AMAA020

Force-Motor Speed Characteristics

- A : Continuous duty zone ——— (solid lines): With three-phase 200-V input
B : Intermittent duty zone - - - - - (dotted lines): With single-phase 200-V input
C : Intermittent duty zone - · - · - (dashed-dotted lines): With single-phase 100-V input

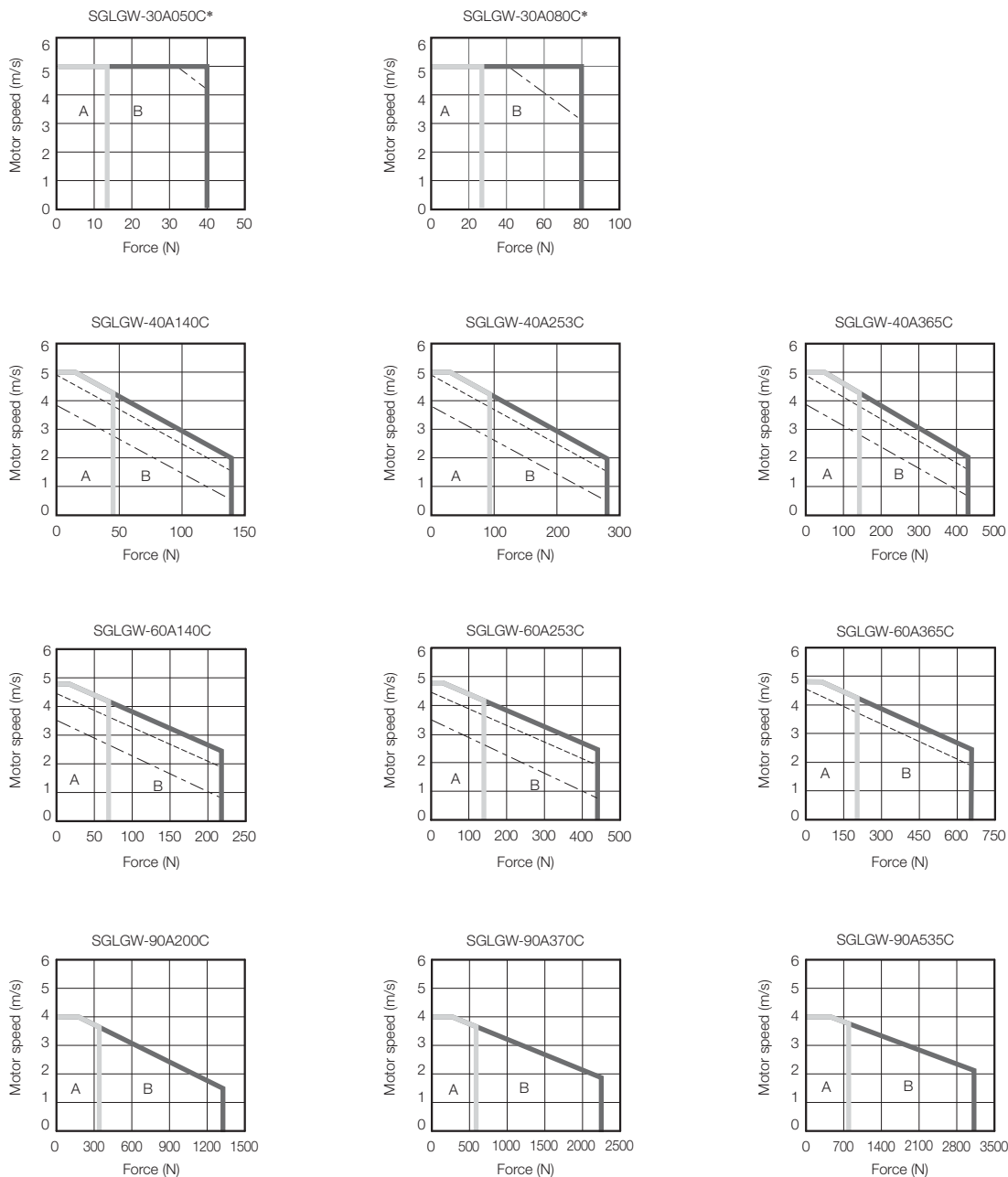

* The characteristics are the same for three-phase 200 V and single-phase 200 V.

Note: 1. These values (typical values) are for operation in combination with a SERVOPACK when the temperature of the armature winding is 100°C.

2. The characteristics in the intermittent duty zone depend on the power supply voltage.
3. If the effective force is within the allowable range for the rated force, the Servomotor can be used within the intermittent duty zone.
4. If you use a Servomotor Main Circuit Cable that exceeds 20 m, the intermittent duty zone in the torque-motor speed characteristics will become smaller because the voltage drop increases.

Servomotor Overload Protection Characteristics

The overload detection level is set for hot start conditions with a Servomotor surrounding air temperature of 40°C.

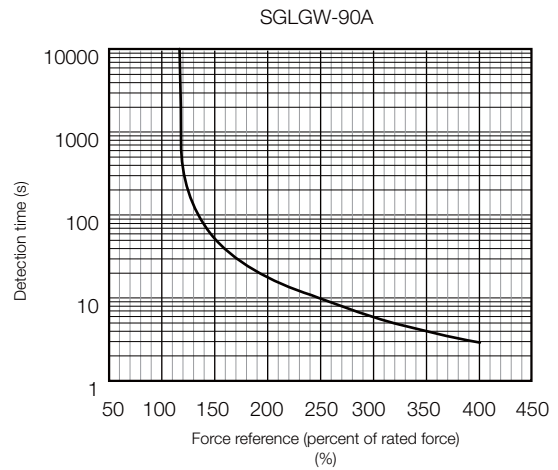
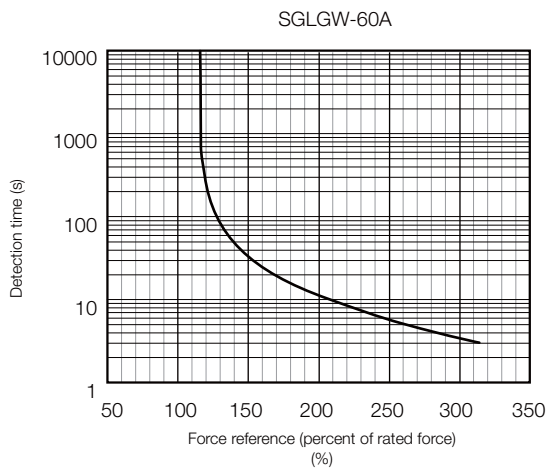
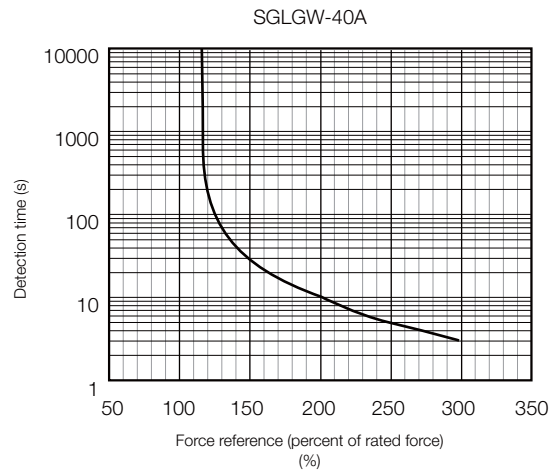
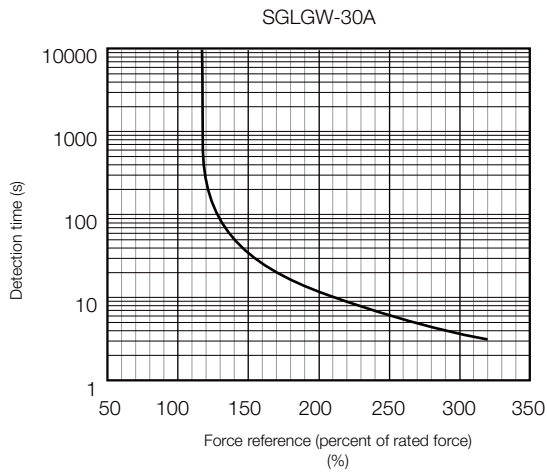

Note: The above overload protection characteristics do not mean that you can perform continuous duty operation with an output of 100% or higher. Use the Servomotor so that the effective force remains within the continuous duty zone given in *Force-Motor Speed Characteristics* on page 222.

Specifications: With High-Force Magnetic Way

Linear Servomotor Moving Coil Model SGLGW-		40A			60A		
		140C	253C	365C	140C	253C	365C
Time Rating		Continuous					
Thermal Class		B					
Insulation Resistance		500 VDC, 10 M Ω min.					
Withstand Voltage		1,500 VAC for 1 minute					
Excitation		Permanent magnet					
Cooling Method		Self-cooled or air-cooled					
Protective Structure		IP00					
Environmental Conditions	Surrounding Air Temperature	0°C to 40°C (with no freezing)					
	Surrounding Air Humidity	20% to 80% relative humidity (with no condensation)					
	Installation Site	<ul style="list-style-type: none"> • Must be indoors and free of corrosive and explosive gases. • Must be well-ventilated and free of dust and moisture. • Must facilitate inspection and cleaning. • Must have an altitude of 1,000 m or less. • Must be free of strong magnetic fields. 					
Shock Resistance	Impact Acceleration Rate	196 m/s ²					
	Number of Impacts	2 times					
Vibration Resistance	Vibration Acceleration Rate	49 m/s ² (the vibration resistance in three directions, vertical, side-to-side, and front-to-back)					

Ratings: With High-Force Magnetic Way

Linear Servomotor Moving Coil Model SGLGW-		40A			60A		
		140C	253C	365C	140C	253C	365C
Rated Motor Speed (Reference Speed during Speed Control)* ¹	m/s	1.0	1.0	1.0	1.0	1.0	1.0
Maximum Speed* ¹	m/s	4.2	4.2	4.2	4.2	4.2	4.2
Rated Force* ^{1, *2}	N	57	114	171	85	170	255
Maximum Force* ¹	N	230	460	690	360	720	1080
Rated Current* ¹	Arms	0.80	1.6	2.4	1.2	2.2	3.3
Maximum Current* ¹	Arms	3.2	6.5	9.7	5.0	10.0	14.9
Moving Coil Mass	kg	0.34	0.60	0.87	0.42	0.76	1.1
Force Constant	N/Arms	76.0	76.0	76.0	77.4	77.4	77.4
BEMF Constant	Vrms/(m/s)/phase	25.3	25.3	25.3	25.8	25.8	25.8
Motor Constant	N/√W	9.62	13.6	16.7	12.9	18.2	22.3
Electrical Time Constant	ms	0.43	0.43	0.43	0.45	0.45	0.45
Mechanical Time Constant	ms	3.7	3.2	3.1	2.5	2.3	2.2
Thermal Resistance (with Heat Sink)	K/W	1.67	0.87	0.58	1.56	0.77	0.51
Thermal Resistance (without Heat Sink)	K/W	3.02	1.80	1.23	2.59	1.48	1.15
Magnetic Attraction	N	0	0	0	0	0	0
Maximum Allowable Payload	kg	12	24	58	18	61	91
Maximum Allowable Payload (With External Regenerative Resistor and External Dynamic Brake Resistor* ³)	kg	12	24	58	18	61	91
Combined Magnetic Way, SGLGM-		40□□□□-M			60□□□□-M		
Combined Serial Converter Unit, JZDP-□□□□-		255	256	257	261	262	263
Applicable SERVOPACKs	SGD7S-	1R6A, 2R1F	2R8A, 2R8F	3R8A	1R6A, 2R1F	3R8A	7R6A
	SGD7W- SGD7C-	1R6A	2R8A	5R5A	1R6A	5R5A	7R6A

*1. These values are for operation in combination with a SERVOPACK when the temperature of the armature winding is 100°C. The values for other items are at 20°C. These are typical values.

*2. The rated forces are the continuous allowable force values at a surrounding air temperature of 40°C with an aluminum heat sink of the dimensions given in the following table.

- Heat Sink Dimensions
 - 200 mm × 300 mm × 12 mm: SGLGW-40A140C and -60A140C
 - 300 mm × 400 mm × 12 mm: SGLGW-40A253C and -60A253C
 - 400 mm × 500 mm × 12 mm: SGLGW-40A365C and -60A365C

*3. To externally connect dynamic brake resistor, select hardware option specification 020 for the SERVOPACK. However, you cannot externally connect dynamic brake resistor if you use the following SERVOPACKs (maximum applicable motor capacity: 400 W).

- SGD7S-R70□□□A020 to -2R8□□□A020
- SGD7W-1R6A20A020 to -2R8A20A020
- SGD7C-1R6AMAA020 to -2R8AMAA020

Force-Motor Speed Characteristics

- A** : Continuous duty zone ——— (solid lines): With three-phase 200-V input
B : Intermittent duty zone - - - - - (dotted lines): With single-phase 200-V input
 - - - (dashed-dotted lines): With single-phase 100-V input

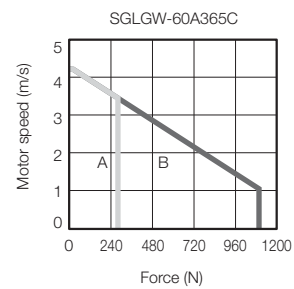
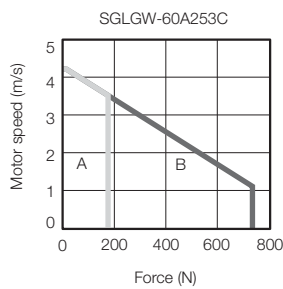
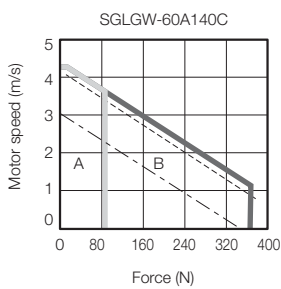
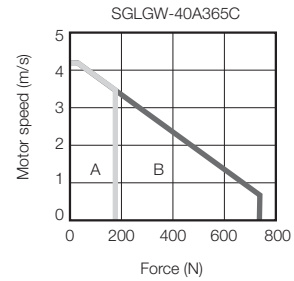
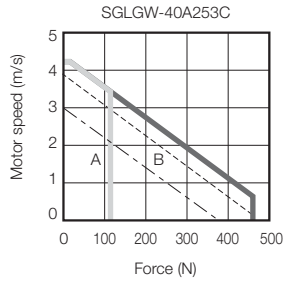
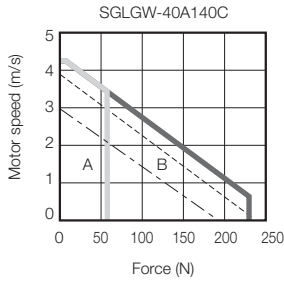

- Note: 1. These values (typical values) are for operation in combination with a SERVOPACK when the temperature of the armature winding is 100°C.
 2. The characteristics in the intermittent duty zone depend on the power supply voltage.
 3. If the effective force is within the allowable range for the rated force, the Servomotor can be used within the intermittent duty zone.
 4. If you use a Servomotor Main Circuit Cable that exceeds 20 m, the intermittent duty zone in the torque-motor speed characteristics will become smaller because the voltage drop increases.

Servomotor Overload Protection Characteristics

The overload detection level is set for hot start conditions with a Servomotor surrounding air temperature of 40°C.

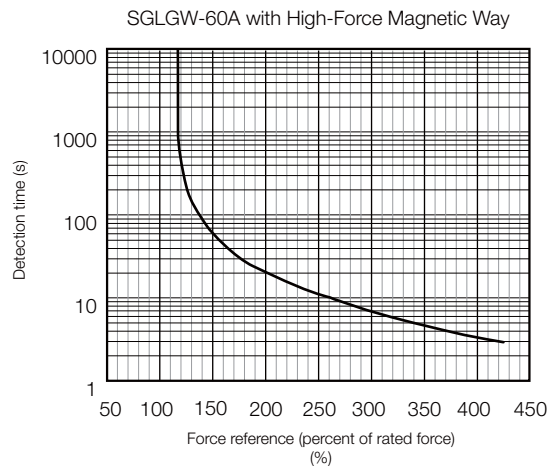
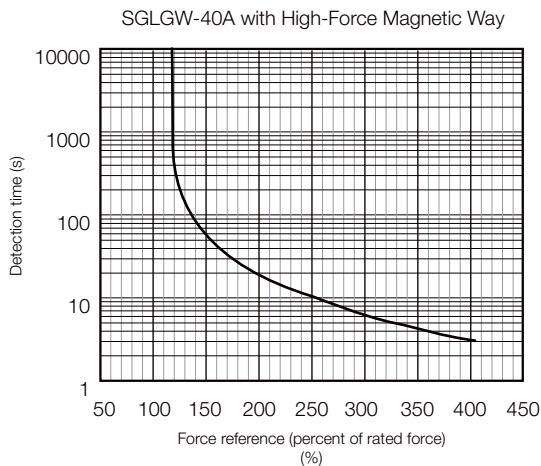

Note: The above overload protection characteristics do not mean that you can perform continuous duty operation with an output of 100% or higher. Use the Servomotor so that the effective force remains within the continuous duty zone given in *Force-Motor Speed Characteristics* on page 226.

External Dimensions

SGLGW-30

◆ Moving Coils: SGLGW-30A□□□C□

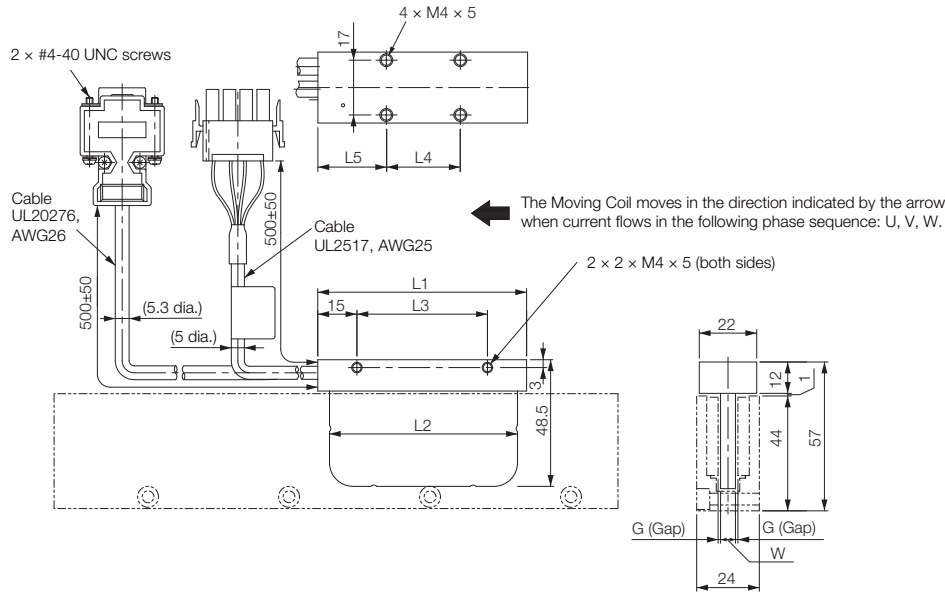

Moving Coil Model SGLGW-	L1	L2	L3	L4	L5	W	G (Gap)	Approx. Mass* [kg]
30A050C□	50	48	30	20	20	5.9	0.85	0.14
30A080C□	80	72	50	30	25	5.7	0.95	0.19

* The mass is for a Moving Coil with a Polarity Sensor.

■ Connector Specifications

• Servomotor Connector

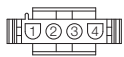

1	Phase U	Red
2	Phase V	White
3	Phase W	Blue
4	FG	Green

Plug: 350779-1
Pins: 350924-1 or 770672-1
From Tyco Electronics Japan G.K.

Mating Connector

Cap: 350780-1
Socket: 350925-1 or 770673-1

• Polarity Sensor Connector

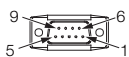

1	+5 V (power supply)	6	Not used
2	Phase U	7	
3	Phase V	8	
4	Phase W	9	
5	0 V (power supply)	-	-

Pin connector: 17JE-23090-02 (D8C)-CG
From DDK Ltd.

Mating Connector

Socket connector: 17JE-13090-02 (D8C)A-CG
Studs: 17L-002C or 17L-002C1

■ Polarity Sensor Output Signal

The figure on the right shows the relationship between the S_u , S_v , and S_w polarity sensor output signals and the inverse power of each motor phase V_u , V_v , and V_w when the Moving Coil moves in the direction indicated by the arrow in the dimensional drawings of the Moving Coil.

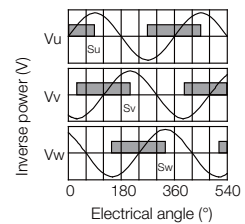

◆ Moving Coils: SGLGW-30A□□□C□□

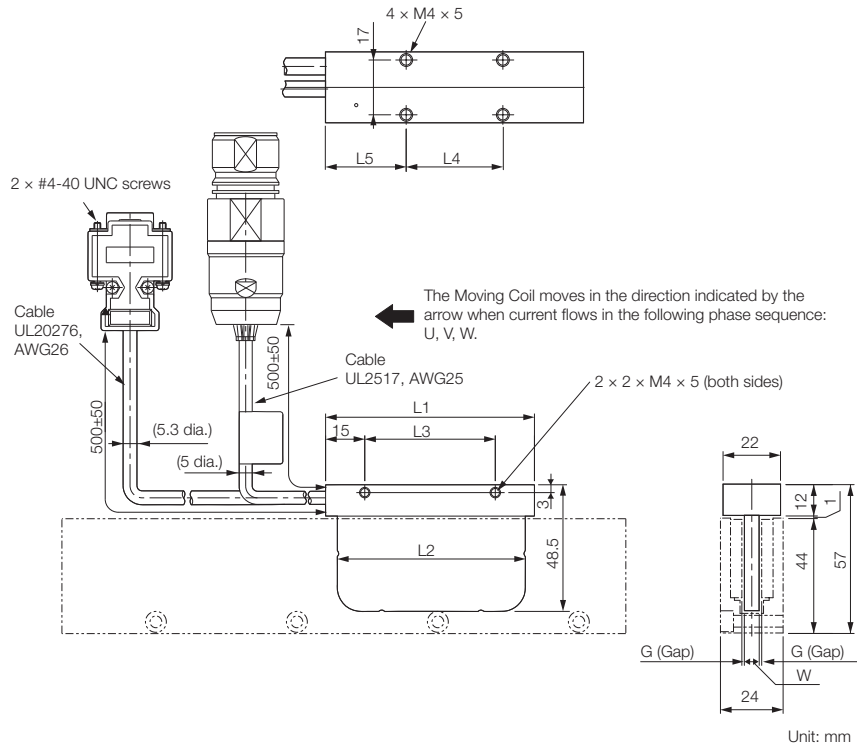

Moving Coil Model SGLGW-	L1	L2	L3	L4	L5	W	G (Gap)	Approx. Mass* [kg]
30A050C□□	50	48	30	20	20	5.9	0.85	0.14
30A080C□□	80	72	50	30	25	5.7	0.95	0.19

* The mass is for a Moving Coil with a Polarity Sensor.

■ Connector Specifications

• Servomotor Connector

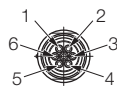

1	Phase U	Red
2	Phase V	White
3	Phase W	Blue
4	Not used	-
5	Not used	-
6	FG	Green

Extension: SROC06JM5CN169
Pins: 021.423.1020
From Interconnectron GmbH

Mating Connector
Plug: SPUC06KFSDN236
Socket: 020.030.1020

• Polarity Sensor Connector

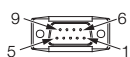

1	+5 V (power supply)	6	Not used
2	Phase U	7	
3	Phase V	8	
4	Phase W	9	
5	0 V (power supply)	-	-

Pin connector: 17JE-23090-02 (D8C)-CG
From DDK Ltd.

Mating Connector
Socket connector: 17JE-13090-02 (D8C)A-CG
Studs: 17L-002C or 17L-002C1

■ Polarity Sensor Output Signal

The figure on the right shows the relationship between the S_u , S_v , and S_w polarity sensor output signals and the inverse power of each motor phase V_u , V_v , and V_w when the Moving Coil moves in the direction indicated by the arrow in the dimensional drawings of the Moving Coil.

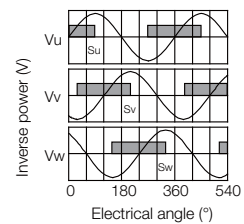

◆ Standard-Force Magnetic Ways: SGLGM-30□□□A

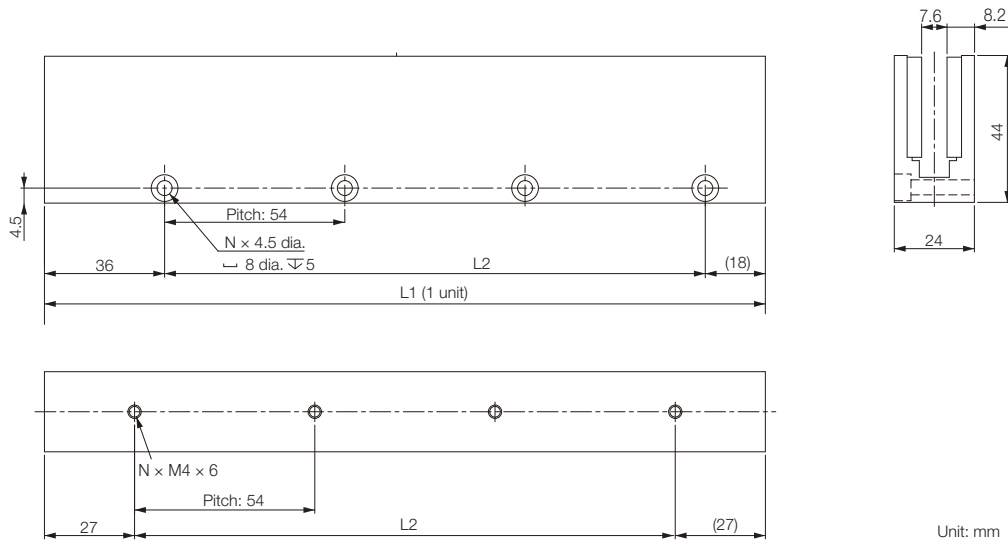

Unit: mm

Magnetic Way Model SGLGM-	L1	L2	N	Approx. Mass [kg]
30108A	108 ^{-0.1} _{-0.1}	54	2	0.6
30216A	216 ^{-0.1} _{-0.1}	162	4	1.1
30432A	432 ^{-0.1} _{-0.1}	378	8	2.3

SGLGW-40

◆ Moving Coils: SGLGW-40A□□□□C□

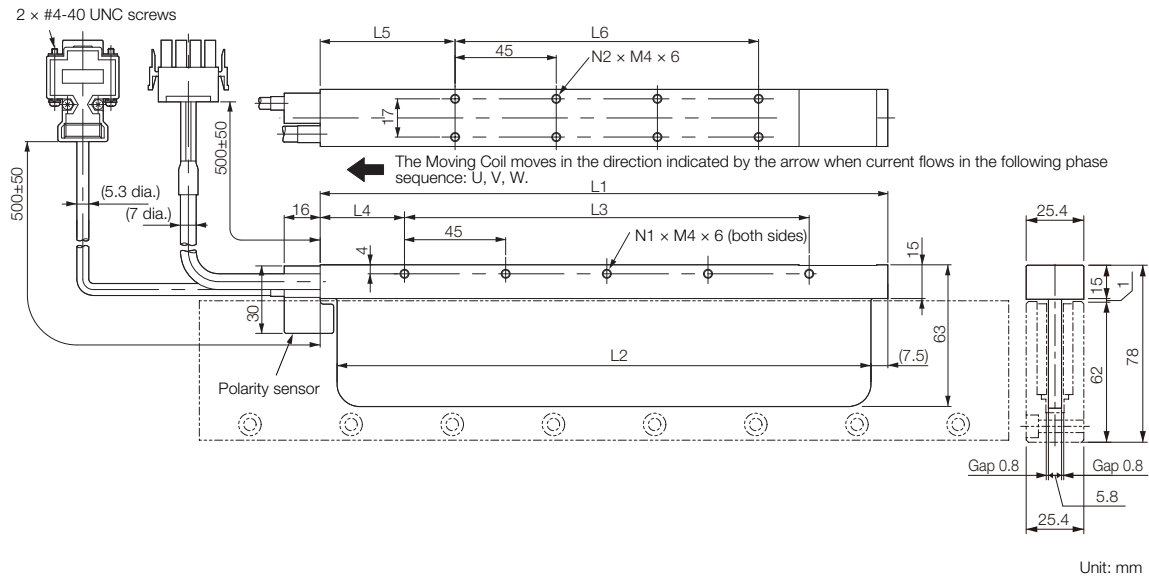

Moving Coil Model SGLGW-	L1	L2	L3	L4	L5	L6	N1	N2	Approx. Mass* [kg]
40A140C□	140	125	90	30	52.5	45	3	4	0.40
40A253C□	252.5	237.5	180	37.5	60	135	5	8	0.66
40A365C□	365	350	315	30	52.5	270	8	14	0.93

* The mass is for a Moving Coil with a Polarity Sensor.

■ Connector Specifications

• Servomotor Connector



1	Phase U	Red
2	Phase V	White
3	Phase W	Blue
4	FG	Green

Plug: 350779-1
Pins: 350561-3 or 350690-3 (No.1 to 3)
350654-1 or 350669-1 (No. 4)

From Tyco Electronics Japan G.K.

Mating Connector

Cap: 350780-1
Socket: 350570-3 or 350689-3

• Polarity Sensor Connector

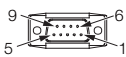

1	+5 V (power supply)	6	Not used
2	Phase U	7	
3	Phase V	8	
4	Phase W	9	
5	0 V (power supply)	-	

Pin connector: 17JE-23090-02 (D8C)-CG
From DDK Ltd.

Mating Connector

Socket connector: 17JE-13090-02 (D8C)A-CG
Studs: 17L-002C or 17L-002C1

■ Polarity Sensor Output Signal

The figure on the right shows the relationship between the S_u , S_v , and S_w polarity sensor output signals and the inverse power of each motor phase V_u , V_v , and V_w when the Moving Coil moves in the direction indicated by the arrow in the dimensional drawings of the Moving Coil.

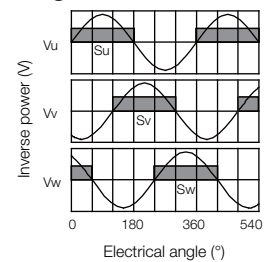

◆ Moving Coils: SGLGW-40A□□□C□□

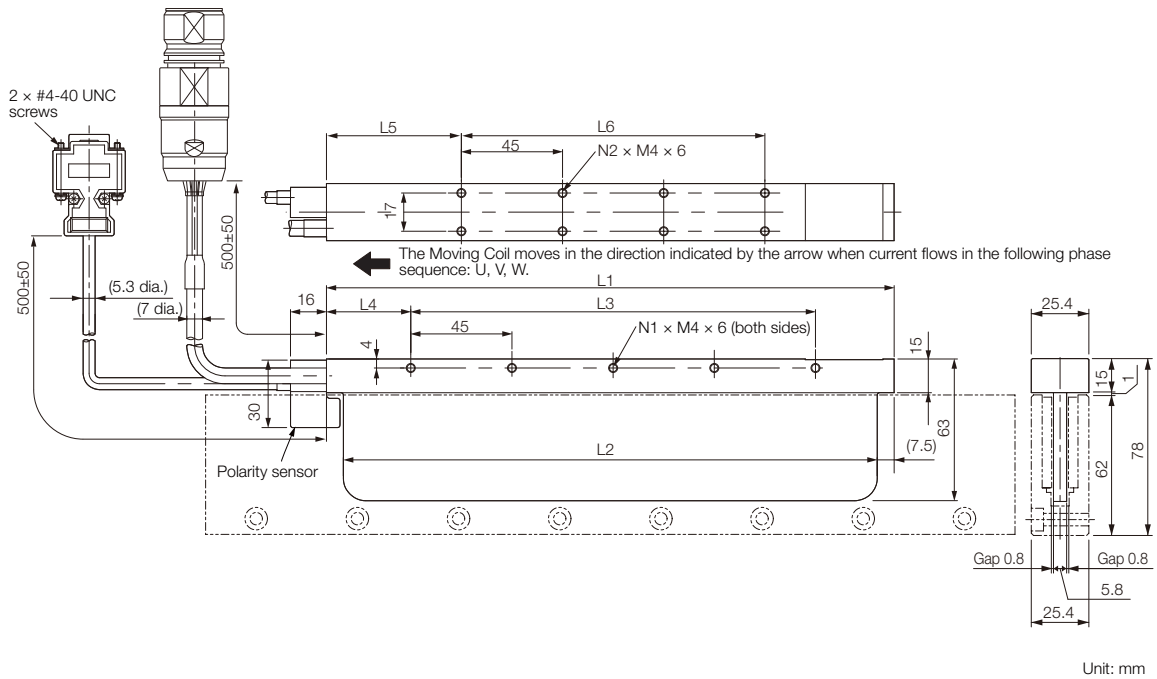

Moving Coil Model SGLGW-	L1	L2	L3	L4	L5	L6	N1	N2	Approx. Mass* [kg]
40A140C□□D	140	125	90	30	52.5	45	3	4	0.40
40A253C□□D	252.5	237.5	180	37.5	60	135	5	8	0.66
40A365C□□D	365	350	315	30	52.5	270	8	14	0.93

* The mass is for a Moving Coil with a Polarity Sensor.

■ Connector Specifications

• Servomotor Connector

1	Phase U	Red
2	Phase V	White
3	Phase W	Blue
4	Not used	-
5	Not used	-
6	FG	Green

Extension: SROC06JM5CN169
Pins: 021.423.1020
From Interconnectron GmbH
Mating Connector
Plug: SPUC06KFSDN236
Socket: 020.030.1020

• Polarity Sensor Connector

1	+5 V (power supply)	6	Not used
2	Phase U	7	
3	Phase V	8	
4	Phase W	9	
5	0 V (power supply)	-	-

Pin connector: 17JE-23090-02 (D8C)-CG
From DDK Ltd.
Mating Connector
Socket connector: 17JE-13090-02 (D8C)A-CG
Studs: 17L-002C or 17L-002C1

■ Polarity Sensor Output Signal

The figure on the right shows the relationship between the S_u , S_v , and S_w polarity sensor output signals and the inverse power of each motor phase V_u , V_v , and V_w when the Moving Coil moves in the direction indicated by the arrow in the dimensional drawings of the Moving Coil.

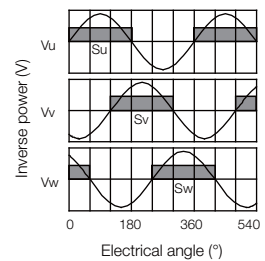

◆ Standard-Force Magnetic Ways:
SGLGM-40□□□C (without Mounting Holes on the Bottom)
SGLGM-40□□□CT (with Mounting Holes on the Bottom)

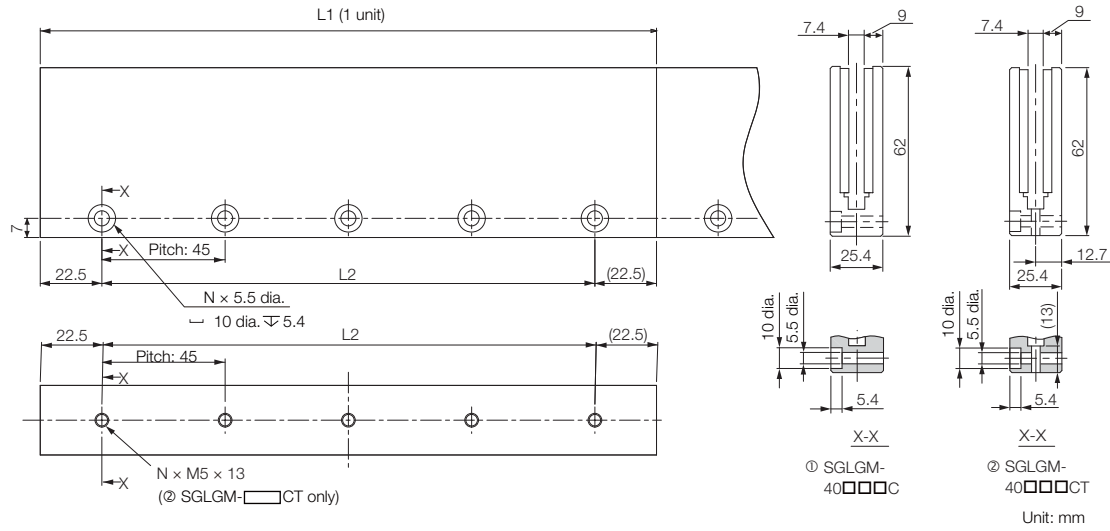

Type	Magnetic Way Model SGLGM-	L1	L2	N	Approx. Mass [kg]
Standard-Force	40090C or 40090CT	90 ^{-0.1} _{-0.3}	45	2	0.8
	40225C or 40225CT	225 ^{-0.1} _{-0.3}	180	5	2.0
	40360C or 40360CT	360 ^{-0.1} _{-0.3}	315	8	3.1
	40405C or 40405CT	405 ^{-0.1} _{-0.3}	360	9	3.5
	40450C or 40450CT	450 ^{-0.1} _{-0.3}	405	10	3.9

◆ High-Force Magnetic Ways:
SGLGM-40□□□C-M (without Mounting Holes on the Bottom)
SGLGM-40□□□CT-M (with Mounting Holes on the Bottom)

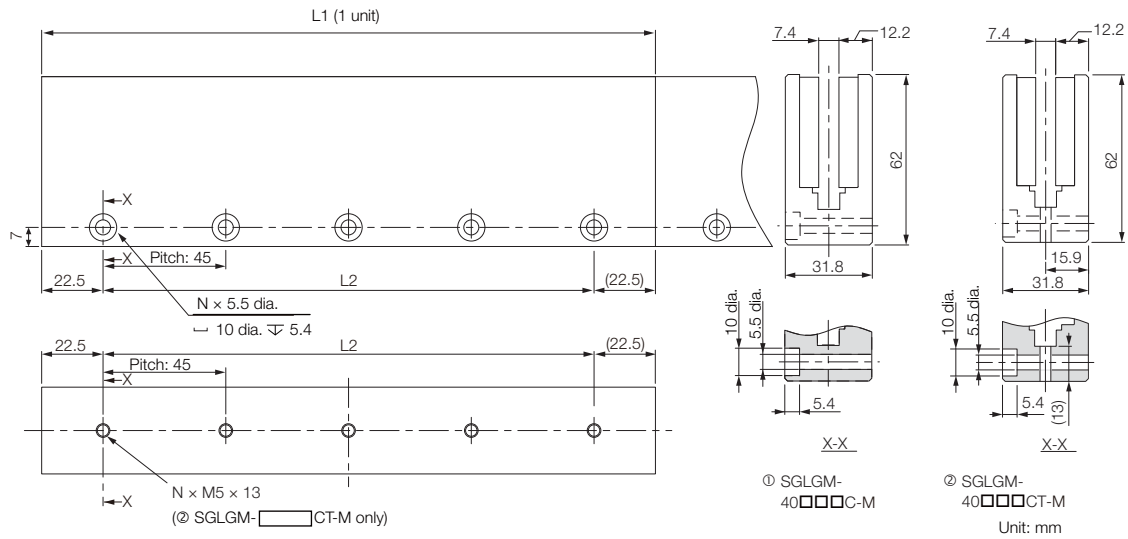

Type	Magnetic Way Model SGLGM-	L1	L2	N	Approx. Mass [kg]
High-Force	40090C-M or 40090CT-M	90 ^{-0.1} _{-0.3}	45	2	1.0
	40225C-M or 40225CT-M	225 ^{-0.1} _{-0.3}	180	5	2.6
	40360C-M or 40360CT-M	360 ^{-0.1} _{-0.3}	315	8	4.1
	40405C-M or 40405CT-M	405 ^{-0.1} _{-0.3}	360	9	4.6
	40450C-M or 40450CT-M	450 ^{-0.1} _{-0.3}	405	10	5.1

SGLGW-60

◆ Moving Coils: SGLGW-60A□□□C□

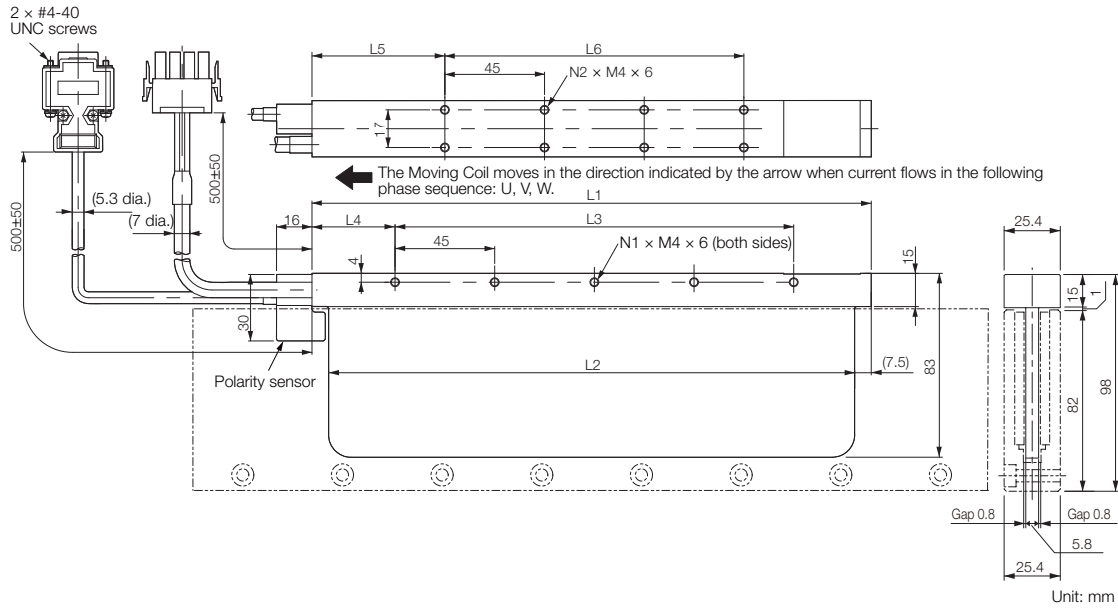

Moving Coil Model SGLGW-	L1	L2	L3	L4	L5	L6	N1	N2	Approx. Mass* [kg]
60A140C□	140	125	90	30	52.5	45	3	4	0.48
60A253C□	252.5	237.5	180	37.5	60	135	5	8	0.82
60A365C□	365	350	315	30	52.5	270	8	14	1.16

* The mass is for a Moving Coil with a Polarity Sensor.

■ Connector Specifications

• Servomotor Connector

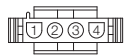

1	Phase U	Red
2	Phase V	White
3	Phase W	Blue
4	FG	Green

Plug: 350779-1

Pins: 350561-3 or 350690-3 (No.1 to 3)
350654-1 or 350669-1 (No. 4)

From Tyco Electronics Japan G.K.

Mating Connector

Cap: 350780-1

Socket: 350570-3 or 350689-3

• Polarity Sensor Connector

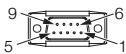

1	+5 V (power supply)	6	Not used
2	Phase U	7	
3	Phase V	8	
4	Phase W	9	
5	0 V (power supply)	-	

Pin connector: 17JE-23090-02 (D8C)-CG

From DDK Ltd.

Mating Connector

Socket connector: 17JE-13090-02 (D8C)A-CG

Studs: 17L-002C or 17L-002C1

■ Polarity Sensor Output Signal

The figure on the right shows the relationship between the S_u , S_v , and S_w polarity sensor output signals and the inverse power of each motor phase V_u , V_v , and V_w when the Moving Coil moves in the direction indicated by the arrow in the dimensional drawings of the Moving Coil.

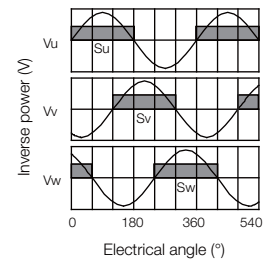

◆ Moving Coils: SGLGW-60A□□□C□□

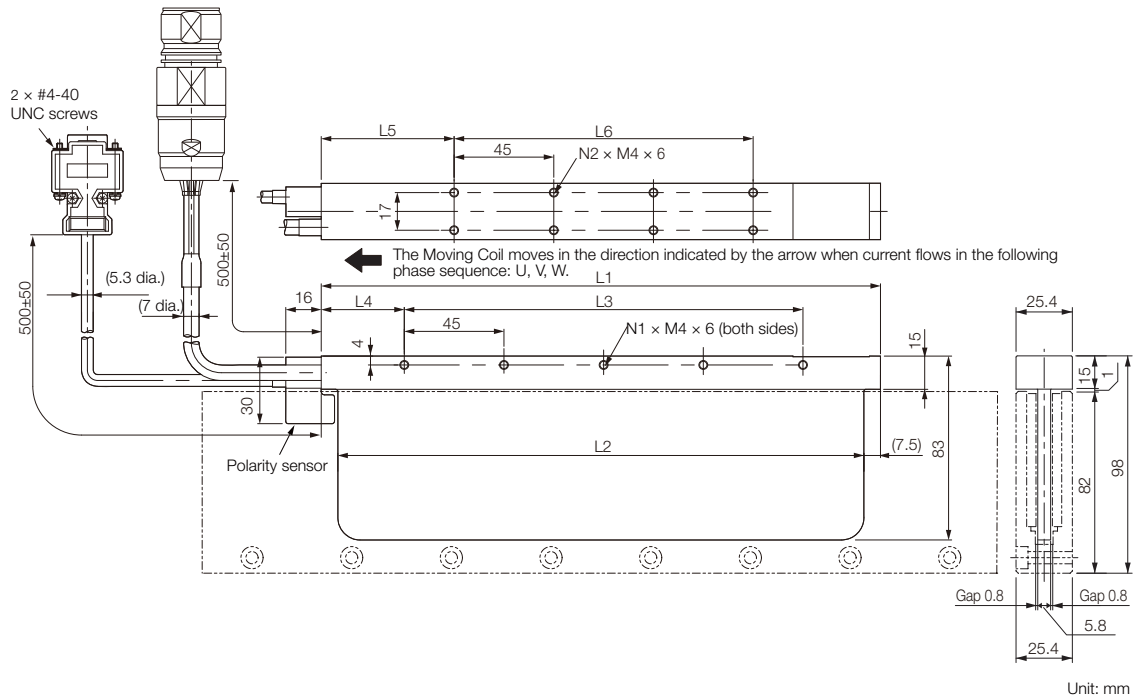

Moving Coil Model SGLGW-	L1	L2	L3	L4	L5	L6	N1	N2	Approx. Mass* [kg]
60A140C□□	140	125	90	30	52.5	45	3	4	0.48
60A253C□□	252.5	237.5	180	37.5	60	135	5	8	0.82
60A365C□□	365	350	315	30	52.5	270	8	14	1.16

* The mass is for a Moving Coil with a Polarity Sensor.

■ Connector Specifications

• Servomotor Connector



1	Phase U	Red
2	Phase V	White
3	Phase W	Blue
4	Not used	-
5	Not used	-
6	FG	Green

Extension: SROC06JMSCN169
Pins: 021.423.1020

From Interconnectron GmbH

Mating Connector

Plug: SPUC06KFSDN236

Socket: 020.030.1020

• Polarity Sensor Connector

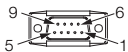

1	+5 V (power supply)	6	Not used
2	Phase U	7	
3	Phase V	8	
4	Phase W	9	
5	0 V (power supply)	-	

Pin connector: 17JE-23090-02 (D8C)-CG

From DDK Ltd.

Mating Connector

Socket connector: 17JE-13090-02 (D8C)A-CG

Studs: 17L-002C or 17L-002C1

■ Polarity Sensor Output Signal

The figure on the right shows the relationship between the S_u , S_v , and S_w polarity sensor output signals and the inverse power of each motor phase V_u , V_v , and V_w when the Moving Coil moves in the direction indicated by the arrow in the dimensional drawings of the Moving Coil.

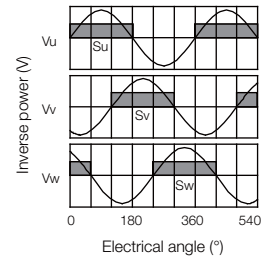

◆ Standard-Force Magnetic Ways:
SGLGM-60□□□C (without Mounting Holes on the Bottom)
SGLGM-60□□□CT (with Mounting Holes on the Bottom)

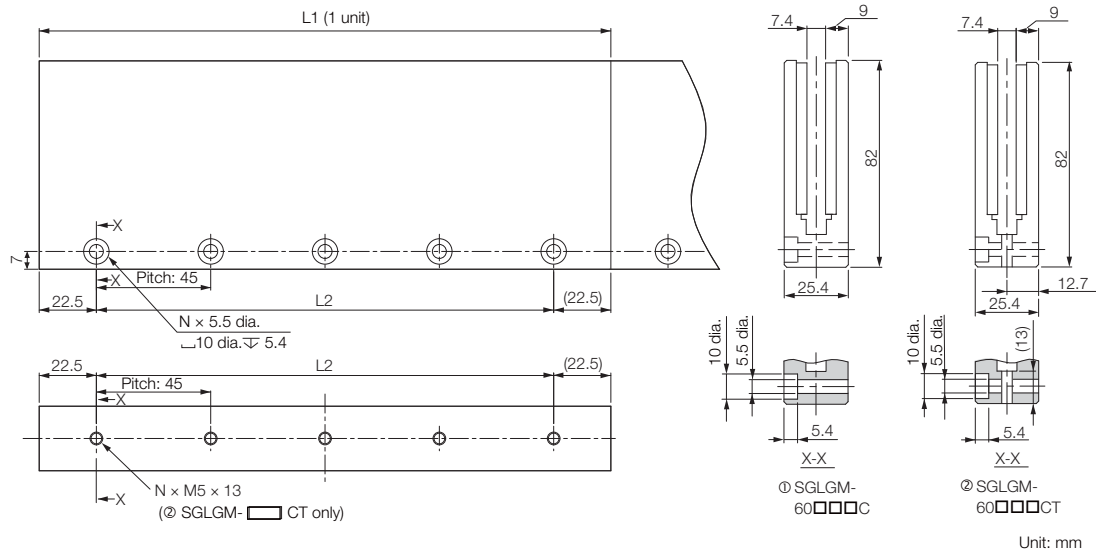

Type	Magnetic Way Model SGLGM-	L1	L2	N	Approx. Mass [kg]
Standard-Force	60090C or 60090CT	90 ^{-0.1} _{-0.3}	45	2	1.1
	60225C or 60225CT	225 ^{-0.1} _{-0.3}	180	5	2.6
	60360C or 60360CT	360 ^{-0.1} _{-0.3}	315	8	4.1
	60405C or 60405CT	405 ^{-0.1} _{-0.3}	360	9	4.6
	60450C or 60450CT	450 ^{-0.1} _{-0.3}	405	10	5.1

◆ High-Force Magnetic Ways:
SGLGM-60□□□C-M (without Mounting Holes on the Bottom)
SGLGM-60□□□CT-M (with Mounting Holes on the Bottom)

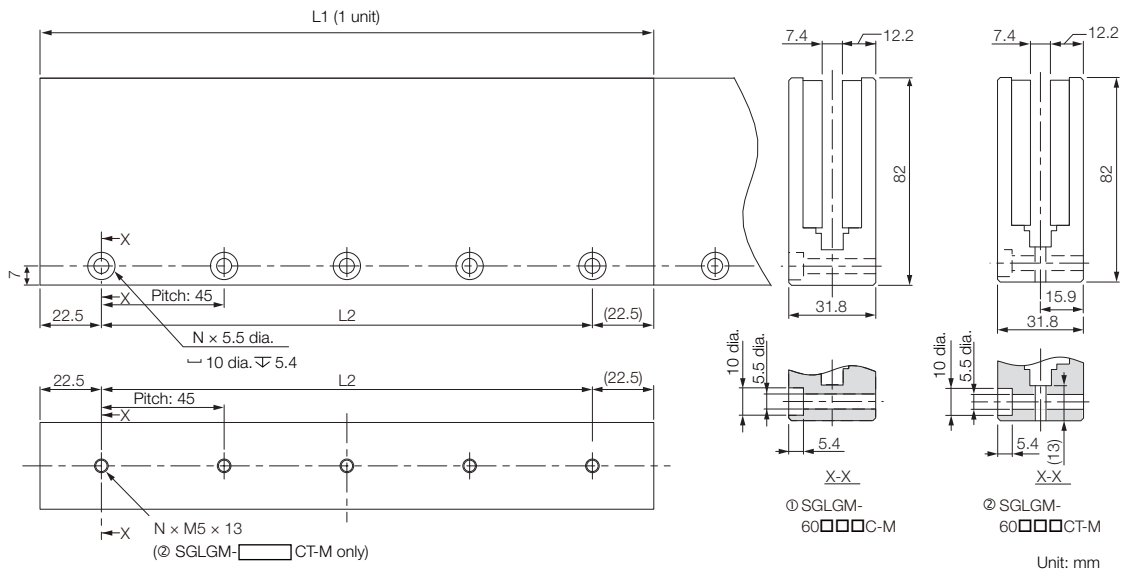

Type	Magnetic Way Model SGLGM-	L1	L2	N	Approx. Mass [kg]
High-Force	60090C-M or 60090CT-M	90 ^{-0.1} _{-0.3}	45	2	1.3
	60225C-M or 60225CT-M	225 ^{-0.1} _{-0.3}	180	5	3.3
	60360C-M or 60360CT-M	360 ^{-0.1} _{-0.3}	315	8	5.2
	60405C-M or 60405CT-M	405 ^{-0.1} _{-0.3}	360	9	5.9
	60450C-M or 60450CT-M	450 ^{-0.1} _{-0.3}	405	10	6.6

SGLGW-90

◆ Moving Coils: SGLGW-90A□□□□

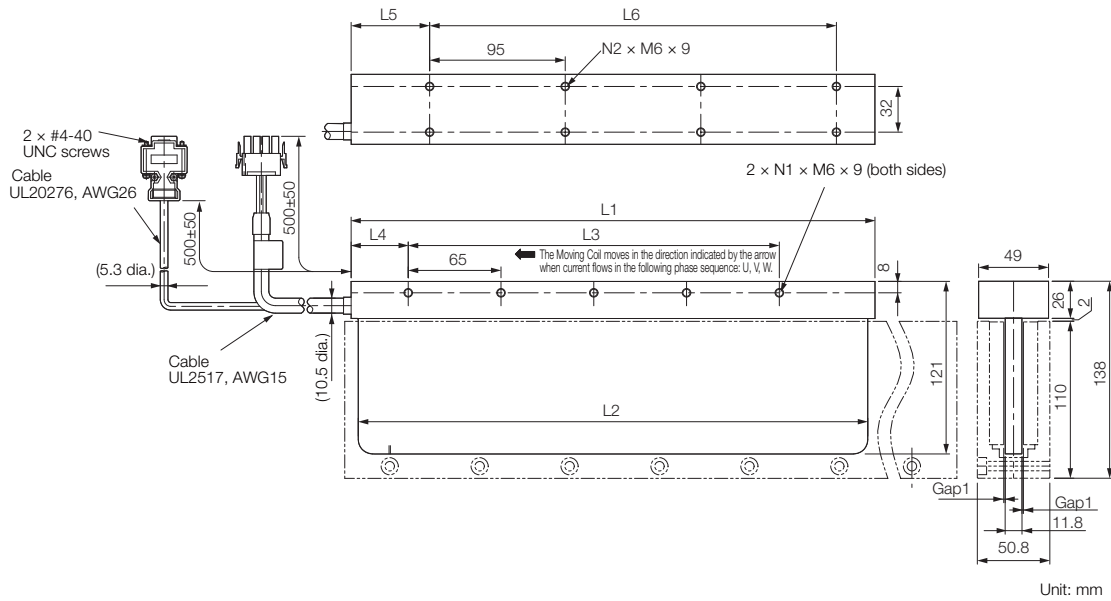

Moving Coil Model SGLGW-	L1	L2	L3	L4	L5	L6	N1	N2	Approx. Mass* [kg]
90A200C□	199	189	130	40	60	95	3	4	2.2
90A370C□	367	357	260	40	55	285	5	8	3.65
90A535C□	535	525	455	40	60	380	8	10	4.95

* The mass is for a Moving Coil with a Polarity Sensor.

■ Connector Specifications

• Servomotor Connector

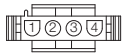

1	Phase U	Red
2	Phase V	White
3	Phase W	Blue
4	FG	Green

Plug: 350779-1
Pins: 350218-3 or 350547-3 (No. 1 to 3)
350654-1 or 350669-1 (No. 4)

From Tyco Electronics Japan G.K.

Mating Connector

Cap: 350780-1
Socket: 350537-3 or 350550-3

• Polarity Sensor Connector

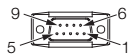

1	+5 V (power supply)	6	Not used
2	Phase U	7	
3	Phase V	8	
4	Phase W	9	
5	0 V (power supply)	-	

Pin connector: 17JE-23090-02 (D8C)-CG
From DDK Ltd.

Mating Connector

Socket connector: 17JE-13090-02 (D8C)A-CG
Studs: 17L-002C or 17L-002C1

■ Polarity Sensor Output Signal

The figure on the right shows the relationship between the S_u , S_v , and S_w polarity sensor output signals and the inverse power of each motor phase V_u , V_v , and V_w when the Moving Coil moves in the direction indicated by the arrow in the dimensional drawings of the Moving Coil.

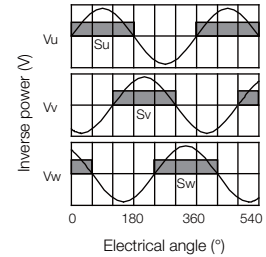

◆ Standard-Force Magnetic Ways: SGLGM-90□□□A

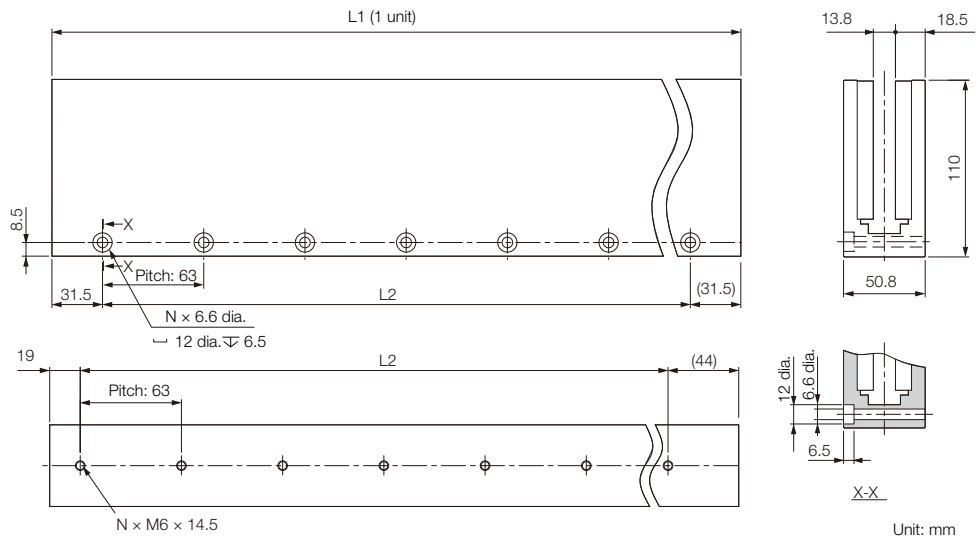

Magnetic Way Model SGLGM-	L1	L2	N	Approx. Mass [kg]
90252A	252 ^{+0.1} _{-0.3}	189	4	7.3
90504A	504 ^{+0.1} _{-0.3}	441	8	14.7

Selecting Cables

◆ Cable Configurations

To select a Linear Encoder, use *Recommended Linear Encoders* (pages 308 and 309). Prepare the cable required for the encoder.

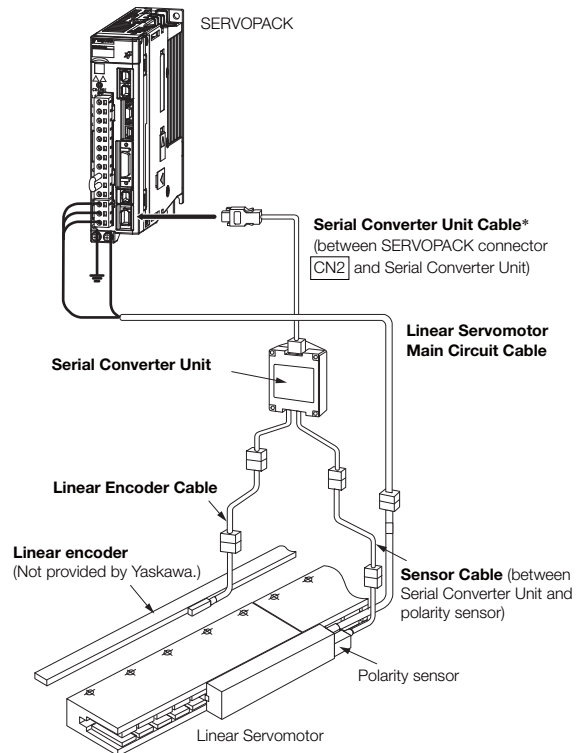

* You can connect directly to an absolute linear encoder.

Note: Refer to the following manual for the following information.

- Cable dimensional drawings and cable connection specifications
- Order numbers and specifications of individual connectors for cables
- Order numbers and specifications for wiring materials

📖 *Σ-7-Series AC Servo Drive Peripheral Device Selection Manual* (Manual No.: SIEP S800001 32)

◆ Linear Servomotor Main Circuit Cables

Linear Servomotor Model	Length (L)	Order Number	Appearance
SGLGW-30A, -40A, -60A	1 m	JZSP-CLN11-01-E	
	3 m	JZSP-CLN11-03-E	
	5 m	JZSP-CLN11-05-E	
	10 m	JZSP-CLN11-10-E	
	15 m	JZSP-CLN11-15-E	
	20 m	JZSP-CLN11-20-E	
SGLGW-90A	1 m	JZSP-CLN21-01-E	
	3 m	JZSP-CLN21-03-E	
	5 m	JZSP-CLN21-05-E	
	10 m	JZSP-CLN21-10-E	
	15 m	JZSP-CLN21-15-E	
	20 m	JZSP-CLN21-20-E	
SGLGW-30A□□□□□□□□ -40A□□□□□□□□ -60A□□□□□□□□	1 m	JZSP-CLN14-01-E	
	3 m	JZSP-CLN14-03-E	
	5 m	JZSP-CLN14-05-E	
	10 m	JZSP-CLN14-10-E	
	15 m	JZSP-CLN14-15-E	
	20 m	JZSP-CLN14-20-E	

*1. Connector from Tyco Electronics Japan G.K.

*2. Connector from Interconnectron GmbH

SGLF (Models with F-type Iron Cores)

Model Designations

SGLFW2 Models

◆ Moving Coil

S G L F W 2 - 30 A 070 A T □

Linear Σ Series Linear Servomotors (1st digit) 2nd digit (3rd+4th digits) 5th digit (6th+7th+8th digits) 9th digit 10th digit 11th digit

1st digit Servomotor Type

Code	Specification
F	With F-type iron core

5th digit Power Supply Voltage

Code	Specification
A	200 VAC

10th digit Sensor Specification

Code	Specification
S	With polarity sensor and Thermal Protector
T	Without polarity sensor, with thermal protector

2nd digit Moving Coil/Magnetic Way

Code	Specification
W	Moving Coil

6th+7th+8th digits Length of Moving Coil

Code	Specification
070	70 mm
120	125 mm
200	205 mm
230	230 mm
380	384 mm
560	563 mm

11th digit Cooling Method

Code	Specification
None	Self-cooled
L	Water-cooled*

3rd+4th digits Magnet Height

Code	Specification
30	30 mm
45	45 mm
90	90 mm
1D	135 mm

9th digit Design Revision Order

A

Note: This information is provided to explain model numbers. It is not meant to imply that models are available for all combinations of codes.

* Contact your Yaskawa representative for information on water-cooled models.

◆ Magnetic Way

S G L F M 2 - 30 270 A

Linear Σ Series Linear Servomotors (1st digit) 2nd digit (3rd+4th digits) (5th+6th+7th digits) 8th digit

1st digit Servomotor Type
(Same as for the Moving Coil.)

5th+6th+7th digits Length of Magnetic Way

Code	Specification
270	270 mm
306	306 mm
450	450 mm
510	510 mm
630	630 mm
714	714 mm

2nd digit Moving Coil/Magnetic Way

Code	Specification
M	Magnetic Way

3rd+4th digits Magnet Height
(Same as for the Moving Coil.)

8th digit Design Revision Order

A

SGLFW Models

◆ Moving Coil



1st digit Servomotor Type

Code	Specification
F	With F-type iron core

5th digit Voltage

Code	Specification
A	200 VAC

10th digit Sensor Specification

Code	Specification
P	With polarity sensor
None	Without polarity sensor

2nd digit Moving Coil/Magnetic Way

Code	Specification
W	Moving Coil

6th+7th+8th digits Length of Moving Coil

Code	Specification
090	91 mm
120	127 mm
200	215 mm
230	235 mm
380	395 mm

11th digit Connector for Servomotor Main Circuit Cable

Code	Specification	Applicable Models
None	Connector from Tyco Electronics Japan G.K.	All models
D	Connector from Interconnectron GmbH	SGLFW-35, -50, -1Z□200B

3rd+4th digits Magnet Height

Code	Specification
20	20 mm
35	36 mm
50	47.5 mm
1Z	95 mm

9th digit Design Revision Order

A, B ...

Note: This information is provided to explain model numbers. It is not meant to imply that models are available for all combinations of codes.

◆ Magnetic Way



1st digit Servomotor Type

(Same as for the Moving Coil.)

5th+6th+7th digits Length of Magnetic Way

Code	Specification
324	324 mm
405	405 mm
540	540 mm
675	675 mm
756	756 mm
945	945 mm

9th digit Options

Code	Specification
None	Without options
C	With magnet cover

2nd digit Moving Coil/Magnetic Way

Code	Specification
M	Magnetic Way

3rd+4th digits Magnet Height

(Same as for the Moving Coil.)

8th digit Design Revision Order

A, B ...

Precautions on Moving Coils with Polarity Sensors



Note

When you use a Moving Coil with a Polarity Sensor, the Magnetic Way must cover the bottom of the polarity sensor. Refer to the example that shows the correct installation.
When determining the length of the Moving Coil's stroke or the length of the Magnetic Way, consider the total length (L) of the Moving Coil and the polarity sensor. Refer to the following table.

Correct Installation

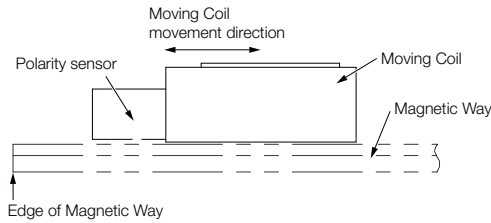

Incorrect Installation

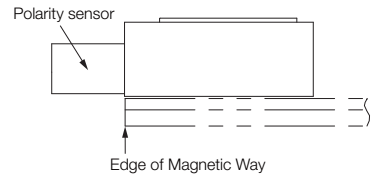

◆ Total Length of Moving Coil with Polarity Sensor

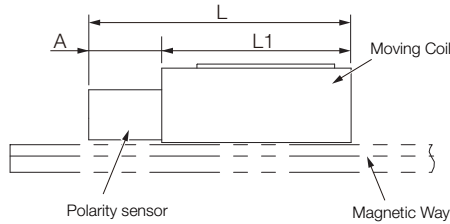

Moving Coil Model SGLFW2-	Length of Moving Coil, L1 [mm]	Length of Polarity Sensor, A [mm]	Total Length, L [mm]
30A070AS	70	29	97
30A120AS	125		152
30A230AS	230		257
45A200AS	205	34	237
45A380AS	384		416
90A200AS	205	34	237
90A380AS	384		416
90A560AS	563		595
1DA380AS	384	32	416
1DA560AS	563		595

Moving Coil Model SGLFW-	Length of Moving Coil, L1 [mm]	Length of Polarity Sensor, A [mm]	Total Length, L [mm]
20A090AP	91	22	113
20A120AP	127		149
35A120AP□	127	22	149
35A230AP□	235		257
50A200BP□	215	22	237
50A380BP□	395		417
1ZA200BP□	215	22	237
1ZA380BP	395		417

Specifications and Ratings: SGLFW2 Models

Specifications

Linear Servomotor Moving Coil Model SGLFW2-		30A			45A		90A			1DA	
		070A□	120A□	230A□	200A□	380A□	200A□	380A□	560A□	380A□	560A□
Time Rating		Continuous									
Thermal Class		B									
Insulation Resistance		500 VDC, 10 MΩ min.									
Withstand Voltage		1,500 VAC for 1 minute									
Excitation		Permanent magnet									
Cooling Method		Self-cooled and water-cooled*									
Protective Structure		IP00									
Environmental Condi- tions	Surrounding Air Tem- perature	0°C to 40°C (with no freezing)									
	Surrounding Air Humidity	20% to 80% relative humidity (with no condensation)									
	Installation Site	<ul style="list-style-type: none"> Must be indoors and free of corrosive and explosive gases. Must be well-ventilated and free of dust and moisture. Must facilitate inspection and cleaning. Must have an altitude of 1,000 m or less. Must be free of strong magnetic fields. 									
Shock Resis- tance	Impact Acceleration Rate	196 m/s ²									
	Number of Impacts	2 times									
Vibra- tion Resis- tance	Vibration Accelera- tion Rate	49 m/s ² (the vibration resistance in three directions, vertical, side-to-side, and front-to-back)									

* Contact your Yaskawa representative for information on water-cooled models.

Linear Servomotors

SGLF (Models with F-type Iron Cores)

Ratings

Linear Servomotor Moving Coil Model SGLFW2-		30A				45A		
		070A□	120A□	230A□		200A□	380A□	
Rated Motor Speed (Reference Speed during Speed Control)* ¹	m/s	4.0	4.0	4.0		4.0	4.0	
Maximum Speed* ¹	m/s	5.0	5.0	5.0		4.5	4.5	
Rated Force* ^{1, *2}	N	45	90	180	170	280	560	
Maximum Force* ¹	N	135	270	540	500	840	1680	1500
Rated Current* ¹	Arms	1.4	1.5	2.9	2.8	4.4	8.7	
Maximum Current* ¹	Arms	5.3	5.2	10.5	9.3	16.4	32.7	27.5
Moving Coil Mass	kg	0.50	0.90	1.7		2.9	5.5	
Force Constant	N/Arms	33.3	64.5	64.5		67.5	67.5	
BEMF Constant	Vrms/ (m/s)/ phase	11.1	21.5	21.5		22.5	22.5	
Motor Constant	N/ \sqrt{W}	11.3	17.3	24.4		36.9	52.2	
Electrical Time Constant	ms	7.6	7.3	7.3		19	19	
Mechanical Time Constant	ms	3.9	3.0	2.9		2.1	2.0	
Thermal Resistance (with Heat Sink)	K/W	2.62	1.17	0.79		0.60	0.44	
Thermal Resistance (without Heat Sink)	K/W	11.3	4.43	2.55		2.64	1.49	
Magnetic Attraction	N	200	630	1260		2120	4240	
Maximum Allowable Payload	kg	5.6	9.4	34	10	58	110	95
Maximum Allowable Payload (With External Regenera- tive Resistor and External Dynamic Brake Resis- tor* ³)	kg	5.6	11	34	20	64	110	110
Combined Magnetic Way, SGLFM2-		30□□□A				45□□□A		
Combined Serial Converter Unit, JZDP-□□□□-		628	629	630		631	632	
Applicable SERVOPACKs	SGD7S-	1R6A, 2R1F		3R8A	2R8A, 2R8F	5R5A	180A	120A
	SGD7W- SGD7C-	1R6A		-	2R8A	5R5A	-	

*1. These values are for operation in combination with a SERVOPACK when the temperature of the armature winding is 100°C. The values for other items are at 20°C. These are typical values.

*2. The rated forces are the continuous allowable force values at a surrounding air temperature of 40°C with an aluminum heat sink of the dimensions given in the following table.

- Heat Sink Dimensions
 - 150 mm × 100 mm × 10 mm: SGLFW2-30A070A
 - 254 mm × 254 mm × 25 mm: SGLFW2-30A120A and -30A230A
 - 400 mm × 500 mm × 10 mm: SGLFW2-45A200A and -45A380A

*3. To externally connect dynamic brake resistor, select hardware option specification 020 for the SERVOPACK. However, you cannot externally connect dynamic brake resistor if you use the following SERVOPACKs (maximum applicable motor capacity: 400 W).

- SGD7S-R70□□□A020 to -2R8□□□A020
- SGD7W-1R6A20A020 to -2R8A20A020
- SGD7C-1R6AMAA020 to -2R8AMAA020

Force-Motor Speed Characteristics

- A : Continuous duty zone ——— (solid lines): With three-phase 200-V input
B : Intermittent duty zone - - - - - (dotted lines): With single-phase 200-V input
C : Intermittent duty zone - · - · - (dashed-dotted lines): With single-phase 100-V input

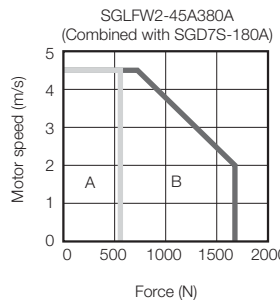
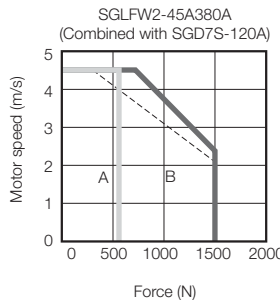
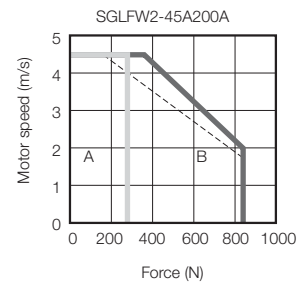
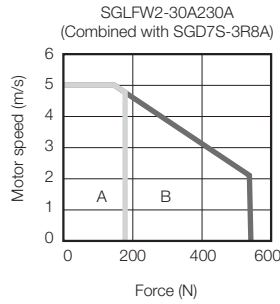
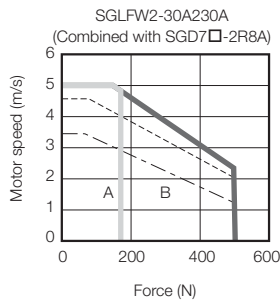
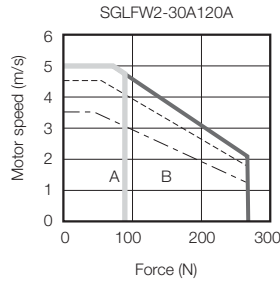
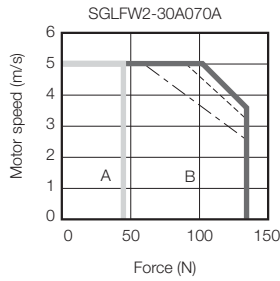

- Note: 1. These values (typical values) are for operation in combination with a SERVOPACK when the temperature of the armature winding is 100°C.
 2. The characteristics in the intermittent duty zone depend on the power supply voltage.
 3. If the effective force is within the allowable range for the rated force, the Servomotor can be used within the intermittent duty zone.
 4. If you use a Servomotor Main Circuit Cable that exceeds 20 m, the intermittent duty zone in the torque-motor speed characteristics will become smaller because the voltage drop increases.

Linear Servomotors

SGLF (Models with F-type Iron Cores)

Ratings

Linear Servomotor Moving Coil Model SGLFW2-		90A			1DA	
		200A□	380A□	560A□	380A□	560A□
Rated Motor Speed (Reference Speed during Speed Control)* ¹	m/s	4.0	4.0	4.0	2.0	2.0
Maximum Speed* ¹	m/s	4.0	4.0	4.0	2.5	2.5
Rated Force* ^{1, *2}	N	560	1120	1680	1680	2520
Maximum Force* ¹	N	1680	3360	5040	5040	7560
Rated Current* ¹	Arms	7.2	14.4	21.6	14.4	21.6
Maximum Current* ¹	Arms	26.9	53.9	80.8	53.9	80.8
Moving Coil Mass	kg	5.3	10.1	14.9	14.6	21.5
Force Constant	N/Arms	82.0	82.0	82.0	123	123
BEMF Constant	Vrms/(m/s)/phase	27.3	27.3	27.3	41.0	41.0
Motor Constant	N/√W	58.1	82.2	101	105	129
Electrical Time Constant	ms	24	23	24	25	25
Mechanical Time Constant	ms	1.6	1.5	1.5	1.3	1.3
Thermal Resistance (with Heat Sink)	K/W	0.45	0.21	0.18	0.18	0.12
Thermal Resistance (without Heat Sink)	K/W	1.81	1.03	0.72	0.79	0.55
Magnetic Attraction	N	4240	8480	12700	12700	19100
Maximum Allowable Payload	kg	130	160	360	690	1000
Maximum Allowable Payload (With External Regenerative Resistor and External Dynamic Brake Resistor)	kg	140	290	440	710	1000
Combined Magnetic Way, SGLFM2-		90□□□A			1D□□□A	
Combined Serial Converter Unit, JZDP-□□□□-		633	634	648	649	650
Applicable SERVOPACKs	SGD7S-	120A	200A	330A	200A	330A
	SGD7W-SGD7C-	-				

*1. These values are for operation in combination with a SERVOPACK when the temperature of the armature winding is 100°C. The values for other items are at 20°C. These are typical values.

*2. The rated forces are the continuous allowable force values at a surrounding air temperature of 40°C with an aluminum heat sink of the dimensions given in the following table.

- Heat Sink Dimensions

- 400 mm × 500 mm × 10 mm: SGLFW2-90A200A
- 609 mm × 762 mm × 10 mm: SGLFW2-90A380A
- 900 mm × 762 mm × 10 mm: SGLFW2-90A560A and -1DA380A
- 1,200 mm × 762 mm × 10 mm: SGLFW2-1DA560A

Force-Motor Speed Characteristics

A : Continuous duty zone — (solid lines): With three-phase 200-V input
B : Intermittent duty zone - - - (dotted lines): With single-phase 200-V input

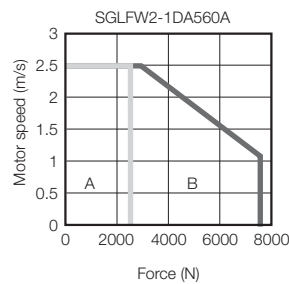
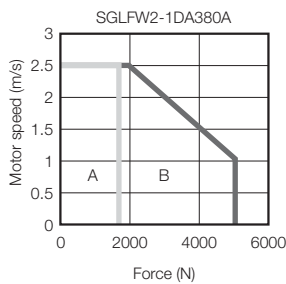
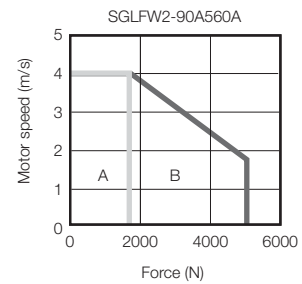
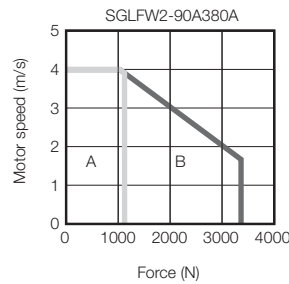
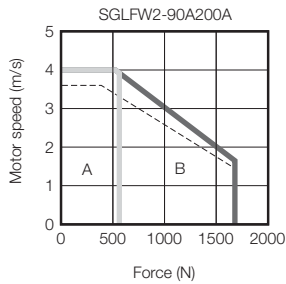

- Note: 1. These values (typical values) are for operation in combination with a SERVOPACK when the temperature of the armature winding is 100°C.
 2. The characteristics in the intermittent duty zone depend on the power supply voltage.
 3. If the effective force is within the allowable range for the rated force, the Servomotor can be used within the intermittent duty zone.
 4. If you use a Servomotor Main Circuit Cable that exceeds 20 m, the intermittent duty zone in the torque-motor speed characteristics will become smaller because the voltage drop increases.

Servomotor Overload Protection Characteristics

The overload detection level is set for hot start conditions with a Servomotor surrounding air temperature of 40°C.

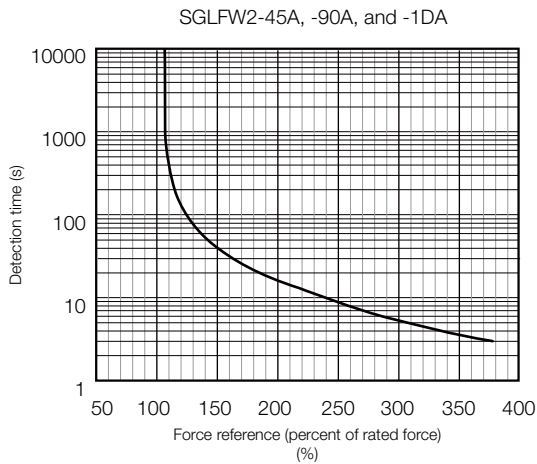
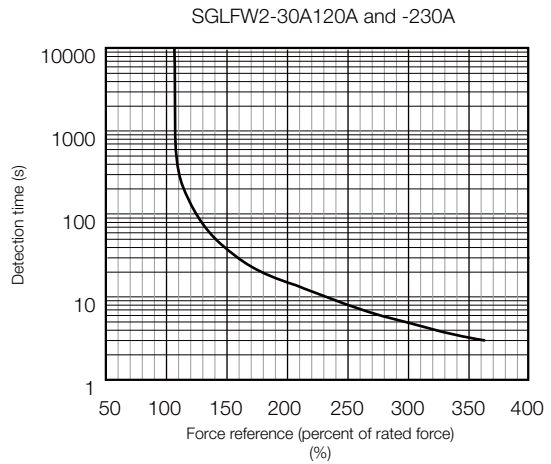
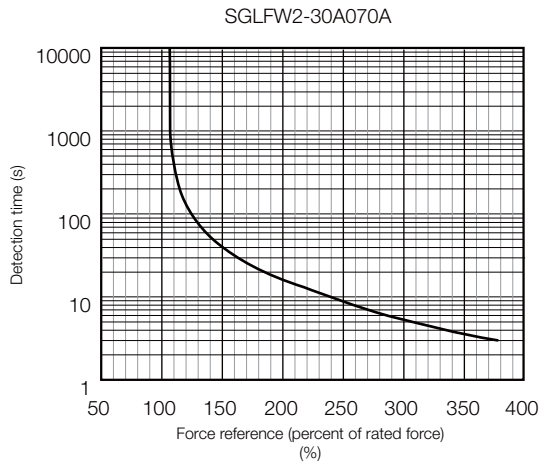

Note: The above overload protection characteristics do not mean that you can perform continuous duty operation with an output of 100% or higher. Use the Servomotor so that the effective force remains within the continuous duty zone given in *Force-Motor Speed Characteristics* on page 247 and on page 249.

Specifications and Ratings: SGLFW Models

Specifications

Linear Servomotor Moving Coil Model SGLFW-		20A		35A		50A		1ZA	
		090A	120A	120A	230A	200B	380B	200B	380B
Time Rating		Continuous							
Thermal Class		B							
Insulation Resistance		500 VDC, 10 MΩ min.							
Withstand Voltage		1,500 VAC for 1 minute							
Excitation		Permanent magnet							
Cooling Method		Self-cooled							
Protective Structure		IP00							
Environmental Condi- tions	Surrounding Air Temperature	0°C to 40°C (with no freezing)							
	Surrounding Air Humidity	20% to 80% relative humidity (with no condensation)							
	Installation Site	<ul style="list-style-type: none"> Must be indoors and free of corrosive and explosive gases. Must be well-ventilated and free of dust and moisture. Must facilitate inspection and cleaning. Must have an altitude of 1,000 m or less. Must be free of strong magnetic fields. 							
Shock Resistance	Impact Acceleration Rate	196 m/s ²							
	Number of Impacts	2 times							
Vibration Resistance	Vibration Acceleration Rate	49 m/s ² (the vibration resistance in three directions, vertical, side-to-side, and front-to-back)							

Ratings

Linear Servomotor Moving Coil Model SGLFW-		20A		35A		50A		1ZA	
		090A	120A	120A	230A	200B	380B	200B	380B
Rated Motor Speed (Reference Speed during Speed Control)*1	m/s	5.0	3.5	2.5	3.0	1.5	1.5	1.5	1.5
Maximum Speed*1	m/s	5.0	5.0	5.0	5.0	5.0	5.0	4.9	4.9
Rated Force*1, *2	N	25	40	80	160	280	560	560	1120
Maximum Force*1	N	86	125	220	440	600	1200	1200	2400
Rated Current*1	Arms	0.70	0.80	1.4	2.8	5.0	10.0	8.7	17.5
Maximum Current*1	Arms	3.0	2.9	4.4	8.8	12.4	25.0	21.6	43.6
Moving Coil Mass	kg	0.70	0.90	1.3	2.3	3.5	6.9	6.4	12
Force Constant	N/Arms	36.0	54.0	62.4	62.4	60.2	60.2	69.0	69.0
BEMF Constant	Vrms/(m/s)/ phase	12.0	18.0	20.8	20.8	20.1	20.1	23.0	23.0
Motor Constant	N/ \sqrt{W}	7.95	9.81	14.4	20.4	34.3	48.5	52.4	74.0
Electrical Time Constant	ms	3.2	3.3	3.6	3.6	16	16	18	18
Mechanical Time Constant	ms	11	9.4	6.3	5.5	3.0	2.9	2.3	2.1
Thermal Resistance (with Heat Sink)	K/W	4.35	3.19	1.57	0.96	0.56	0.38	0.47	0.20
Thermal Resistance (without Heat Sink)	K/W	7.69	5.02	4.10	1.94	1.65	0.95	1.30	0.73
Magnetic Attraction	N	310	460	810	1590	1650	3260	3300	6520
Maximum Allowable Payload	kg	3.2	4.8	8.7	29	33	67	66	78
Maximum Allowable Payload (With External Regenerative Resistor and External Dynamic Brake Resistor*3)	kg	3.2	4.8	8.7	29	40	80	82	160
Combined Magnetic Way, SGLFM-		20□□□□□□		35□□□□□□		50□□□□□□		1Z□□□□□□	
Combined Serial Converter Unit, JZDP-□□□□-		017	018	019	020	181	182	183	184
Applicable SERVOPACKs	SGD7S-	1R6A, 2R1F			3R8A	5R5A	120A		200A
	SGD7W- SGD7C-	1R6A			5R5A		-		

*1. These values are for operation in combination with a SERVOPACK when the temperature of the armature winding is 100°C. The values for other items are at 20°C. These are typical values.

*2. The rated forces are the continuous allowable force values at a surrounding air temperature of 40°C with an aluminum heat sink of the dimensions given in the following table.

- Heat Sink Dimensions
 - 125 mm × 125 mm × 13 mm: SGLFW-20A090A and -20A120A
 - 254 mm × 254 mm × 25 mm: SGLFW-35A120A and -35A230A
 - 400 mm × 500 mm × 40 mm: SGLFW-50A200B, 50A380B, and -1ZA200B
 - 600 mm × 762 mm × 50 mm: SGLFW-1ZA380B

*3. To externally connect dynamic brake resistor, select hardware option specification 020 for the SERVOPACK. However, you cannot externally connect dynamic brake resistor if you use the following SERVOPACKs (maximum applicable motor capacity: 400 W).

- SGD7S-R70□□□□A020 to -2R8□□□□A020
- SGD7W-1R6A20A020 to -2R8A20A020
- SGD7C-1R6AMAA020 to -2R8AMAA020

Force-Motor Speed Characteristics

- A** : Continuous duty zone ——— (solid lines): With three-phase 200-V input
B : Intermittent duty zone - - - - - (dotted lines): With single-phase 200-V input
 — - — (dashed-dotted lines): With single-phase 100-V input

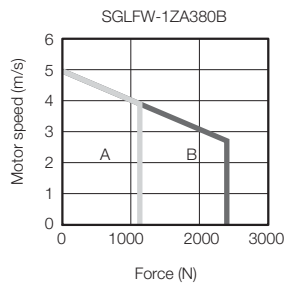
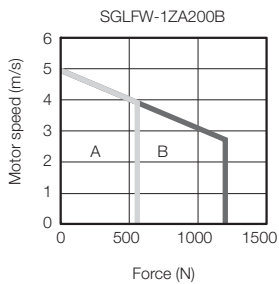
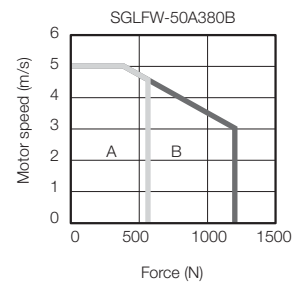
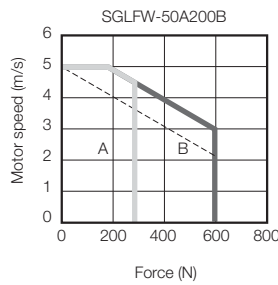
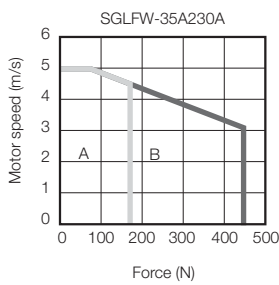
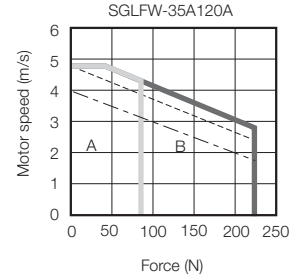
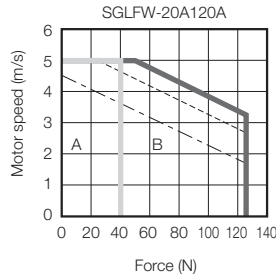
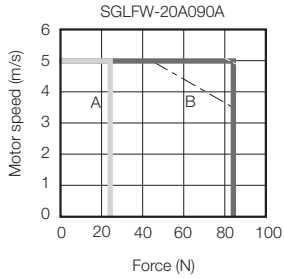

- Note: 1. These values (typical values) are for operation in combination with a SERVOPACK when the temperature of the armature winding is 100°C.
 2. The characteristics in the intermittent duty zone depend on the power supply voltage.
 3. If the effective force is within the allowable range for the rated force, the Servomotor can be used within the intermittent duty zone.
 4. If you use a Servomotor Main Circuit Cable that exceeds 20 m, the intermittent duty zone in the torque-motor speed characteristics will become smaller because the voltage drop increases.

Servomotor Overload Protection Characteristics

The overload detection level is set for hot start conditions with a Servomotor surrounding air temperature of 40°C.

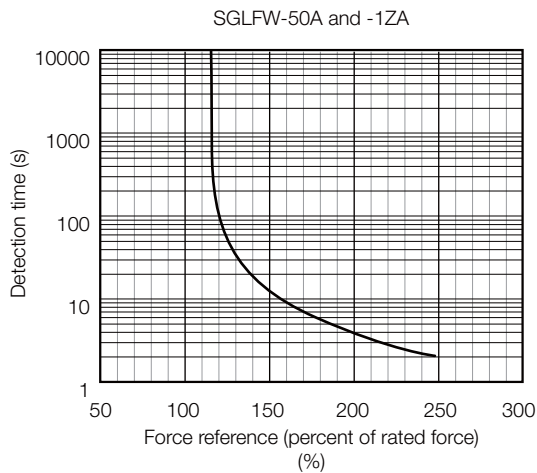
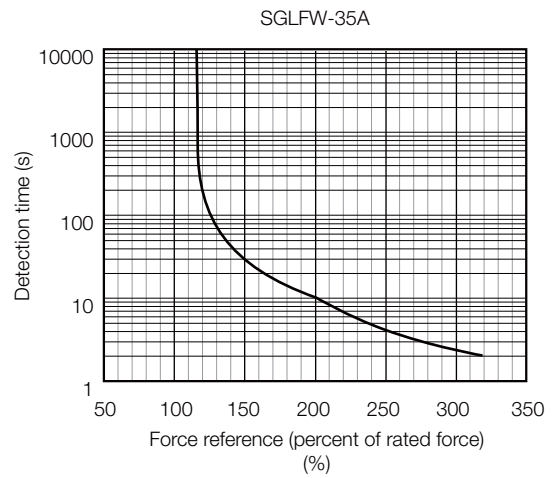
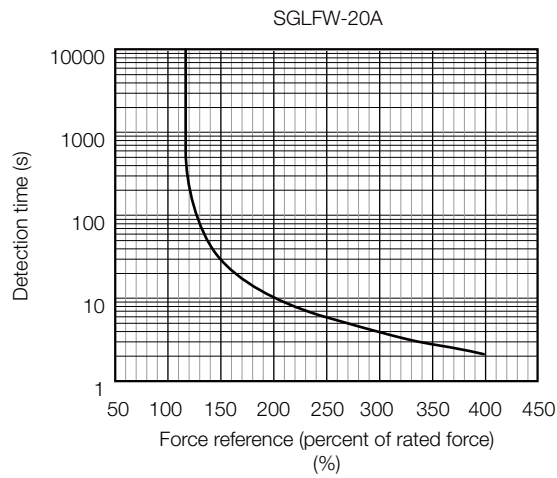

Note: The above overload protection characteristics do not mean that you can perform continuous duty operation with an output of 100% or higher. Use the Servomotor so that the effective force remains within the continuous duty zone given in *Force-Motor Speed Characteristics* on page 253.

External Dimensions

SGLFW2-30

◆ Moving Coil with Polarity Sensor: SGLFW2-30A070AS

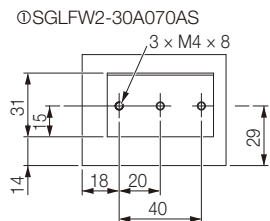
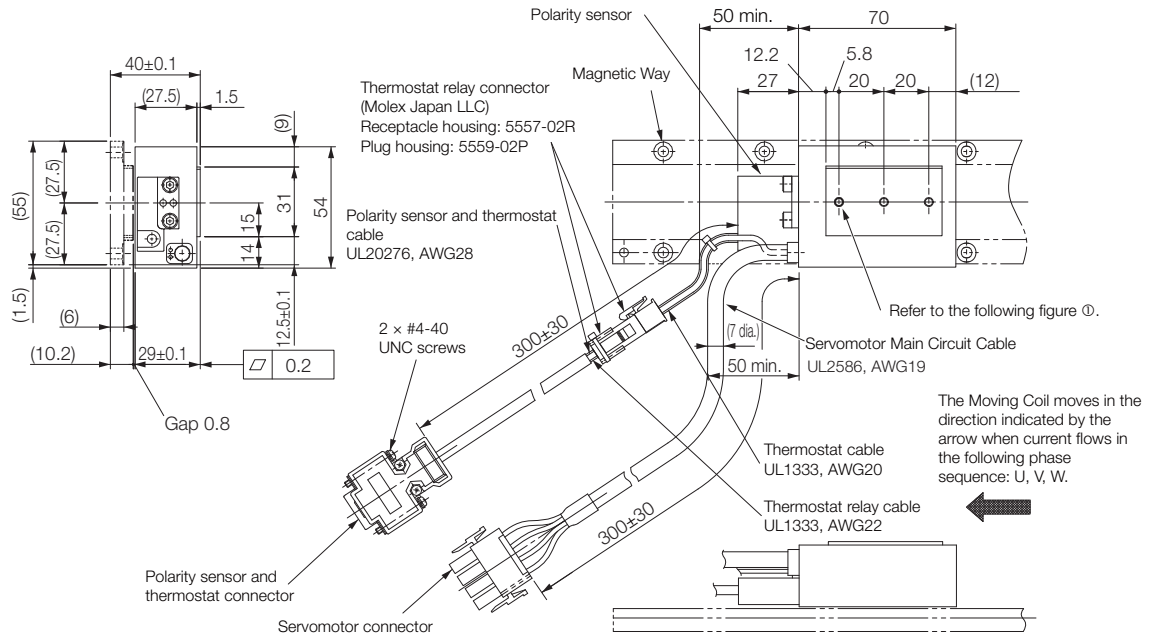

Approx. mass: 0.5 kg
Unit: mm

■ Connector Specifications

• Servomotor Connector

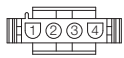

1	Phase U	Red
2	Phase V	White
3	Phase W	Black
4	FG	Green

Plug: 350779-1
Pins: 350218-3 or 350547-3 (No.1 to 3)
350654-1 or 350669-1 (No. 4)
From Tyco Electronics Japan G.K.
Mating Connector
Cap: 350780-1
Socket: 350536-3 or 350550-3

• Polarity Sensor and Thermostat Connector

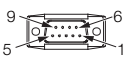

1	+5 V (thermal protector), +5 V (power supply)	6	Not used
2	Su	7	
3	Sv	8	
4	Sw	9	
5	0 V (power supply)		

Pin connector: 17JE-23090-02 (D8C) -CG
From DDK Ltd.

Mating Connector

Socket connector: 17JE-13090-02 (D8C) A-CG
Studs: 17L-002C or 17L-002C1

■ Polarity Sensor Output Signal

The figure on the right shows the relationship between the Su, Sv, and Sw polarity sensor output signals and the inverse power of each motor phase Vu, Vv, and Vw when the Moving Coil moves in the direction indicated by the arrow in the dimensional drawings of the Moving Coil.

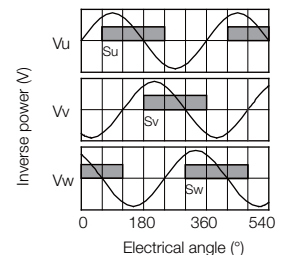

◆ Moving Coils with Polarity Sensors: SGLFW2-30A□□□AS

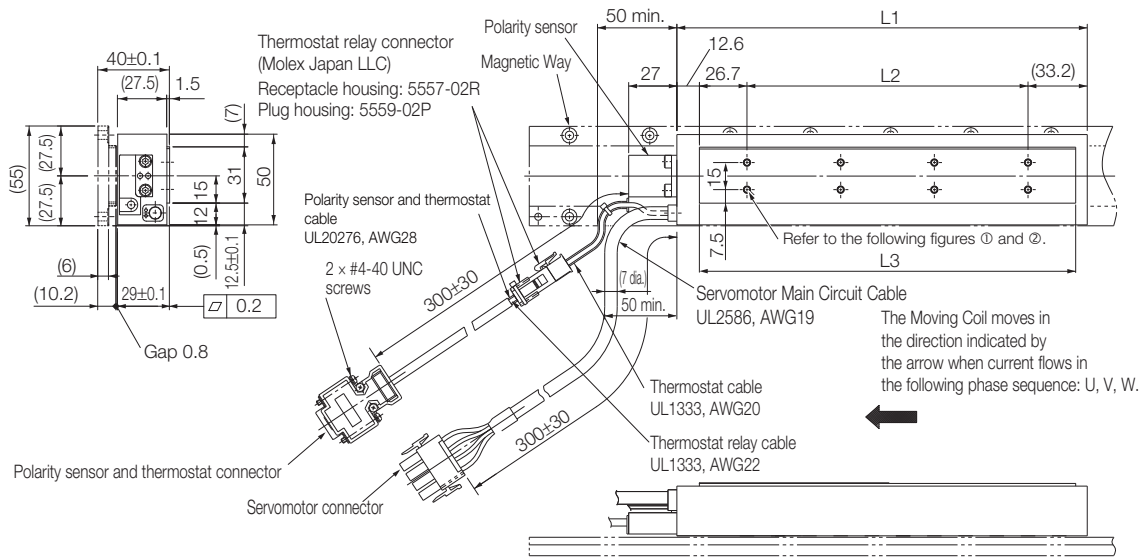

①SGLFW2-30A120AS

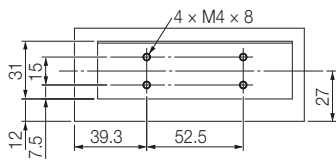

②SGLFW2-30A230AS

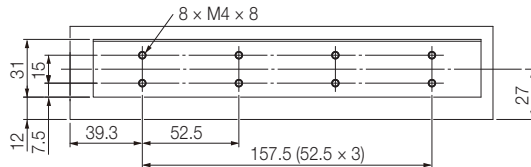

Unit: mm

Moving Coil Model SGLFW2-	L1	L2	L3	Approx. Mass [kg]
30A120AS	125	52.5	105.9	0.9
30A230AS	230	157.5	210.9	1.7

■ Connector Specifications

• Servomotor Connector

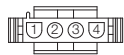

1	Phase U	Red
2	Phase V	White
3	Phase W	Black
4	FG	Green

Plug: 350779-1
Pins: 350218-3 or 350547-3 (No.1 to 3)
350654-1 or 350669-1 (No. 4)
From Tyco Electronics Japan G.K.
Mating Connector
Cap: 350780-1
Socket: 350536-3 or 350550-3

• Polarity Sensor and Thermostat Connector

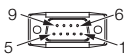

1	+5 V (thermal protector), +5 V (power supply)		
2	Su	6	Not used
3	Sv	7	
4	Sw	8	
5	0 V (power supply)	9	Thermal protector

Pin connector: 17JE-23090-02 (D8C) -CG
From DDK Ltd.
Mating Connector
Socket connector: 17JE-13090-02 (D8C) A-CG
Studs: 17L-002C or 17L-002C1

■ Polarity Sensor Output Signal

The figure on the right shows the relationship between the Su, Sv, and Sw polarity sensor output signals and the inverse power of each motor phase Vu, Vv, and Vw when the Moving Coil moves in the direction indicated by the arrow in the dimensional drawings of the Moving Coil.

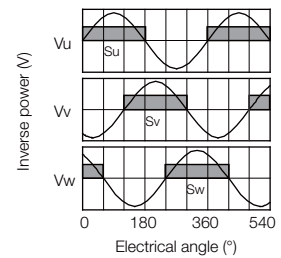

◆ Moving Coil without Polarity Sensor: SGLFW2-30A070AT

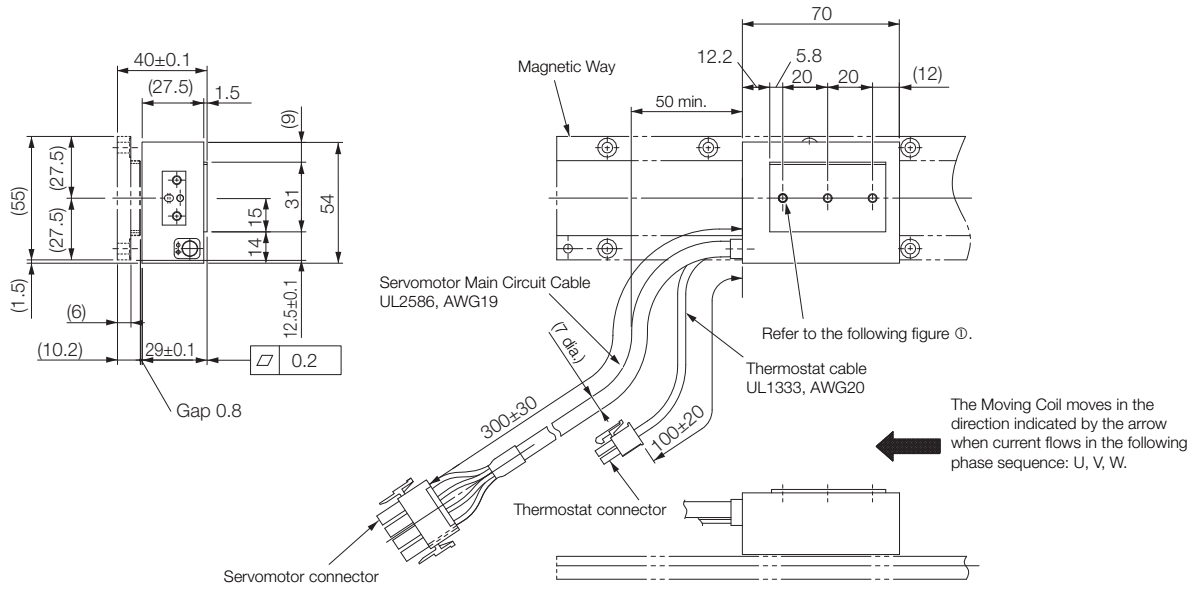

ⓄSGLFW2-30A070AT

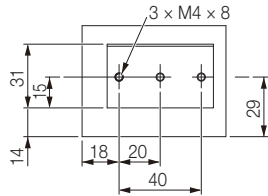

Approx. mass: 0.5 kg
Unit: mm

■ Connector Specifications

• Servomotor Connector



1	Phase U	Red
2	Phase V	White
3	Phase W	Black
4	FG	Green

Plug: 350779-1
Pins: 350218-3 or 350547-3 (No.1 to 3)
350654-1 or 350669-1 (No. 4)
From Tyco Electronics Japan G.K.

Mating Connector

Cap: 350780-1
Socket: 350536-3 or 350550-3

• Thermostat Connector

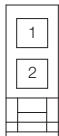

1	Thermal protector
2	Thermal protector

Receptacle housing: 5557-02R
Terminals: 5556T or 5556TL
From Molex Japan LLC

Mating Connector

Plug housing: 5559-02P
Terminals: 5558T or 5558TL

◆ Moving Coils without Polarity Sensors: SGLFW2-30A□□□AT

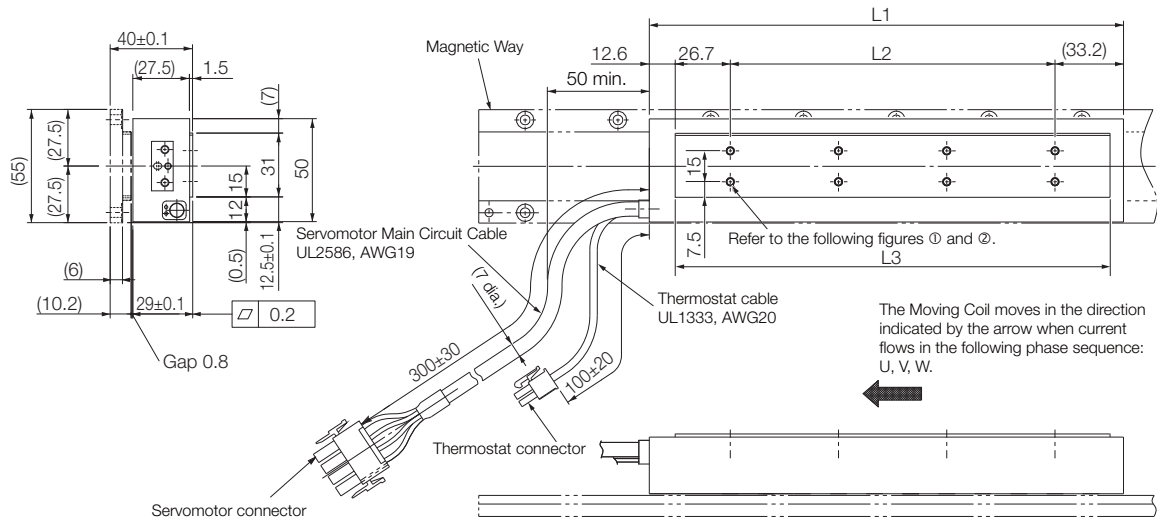

① SGLFW2-30A120AT

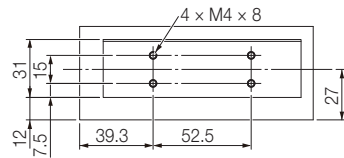

② SGLFW2-30A230AT

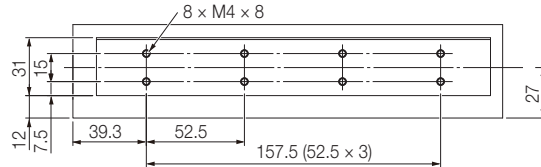

Unit: mm

Moving Coil Model SGLFW2-	L1	L2	L3	Approx. Mass [kg]
30A120AT	125	52.5	105.9	0.9
30A230AT	230	157.5	210.9	1.7

■ Connector Specifications

• Servomotor Connector

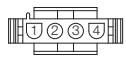

1	Phase U	Red
2	Phase V	White
3	Phase W	Black
4	FG	Green

Plug: 350779-1
Pins: 350218-3 or 350547-3 (No.1 to 3)
350654-1 or 350669-1 (No. 4)
From Tyco Electronics Japan G.K.

Mating Connector

Cap: 350780-1
Socket: 350536-3 or 350550-3

• Thermostat Connector

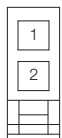

1	Thermal protector
2	Thermal protector

Receptacle housing: 5557-02R
Terminals: 5556T or 5556TL
From Molex Japan LLC

Mating Connector

Plug housing: 5559-02P
Terminals: 5558T or 5558TL

◆ Magnetic Ways: SGLFM2-30□□□A

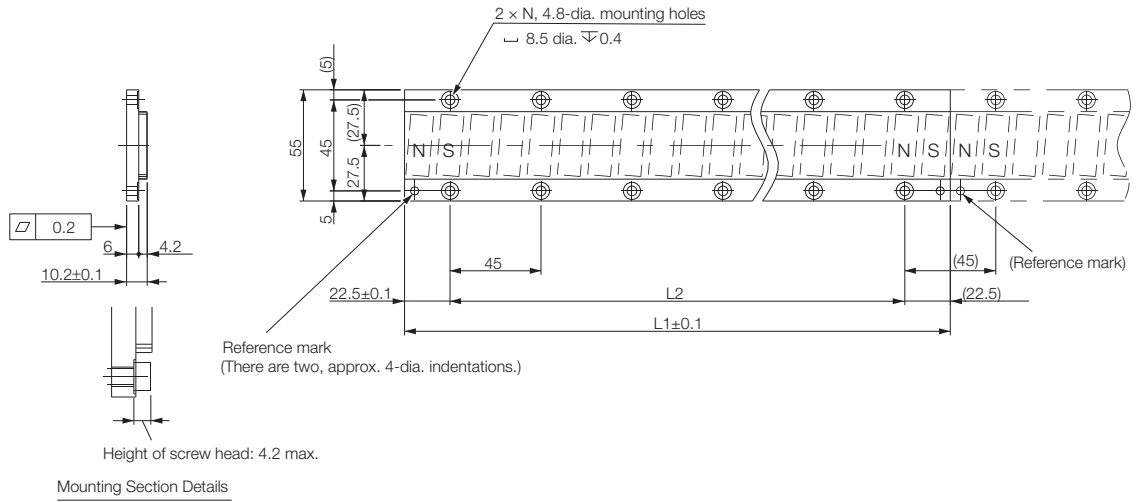

Unit: mm

Note: More than one Magnetic Way can be connected. Connect the Magnetic Ways so that the reference marks on them are aligned in the same direction as shown in the figure.

Magnetic Way Model SGLFM2-	L1 ± 0.1	L2	N	Approx. Mass [kg]
30270A	270	225 (45 × 5)	6	0.9
30450A	450	405 (45 × 9)	10	1.5
30630A	630	585 (45 × 13)	14	2.0

SGLFW2-45

◆ Moving Coils with Polarity Sensors: SGLFW2-45A□□□AS

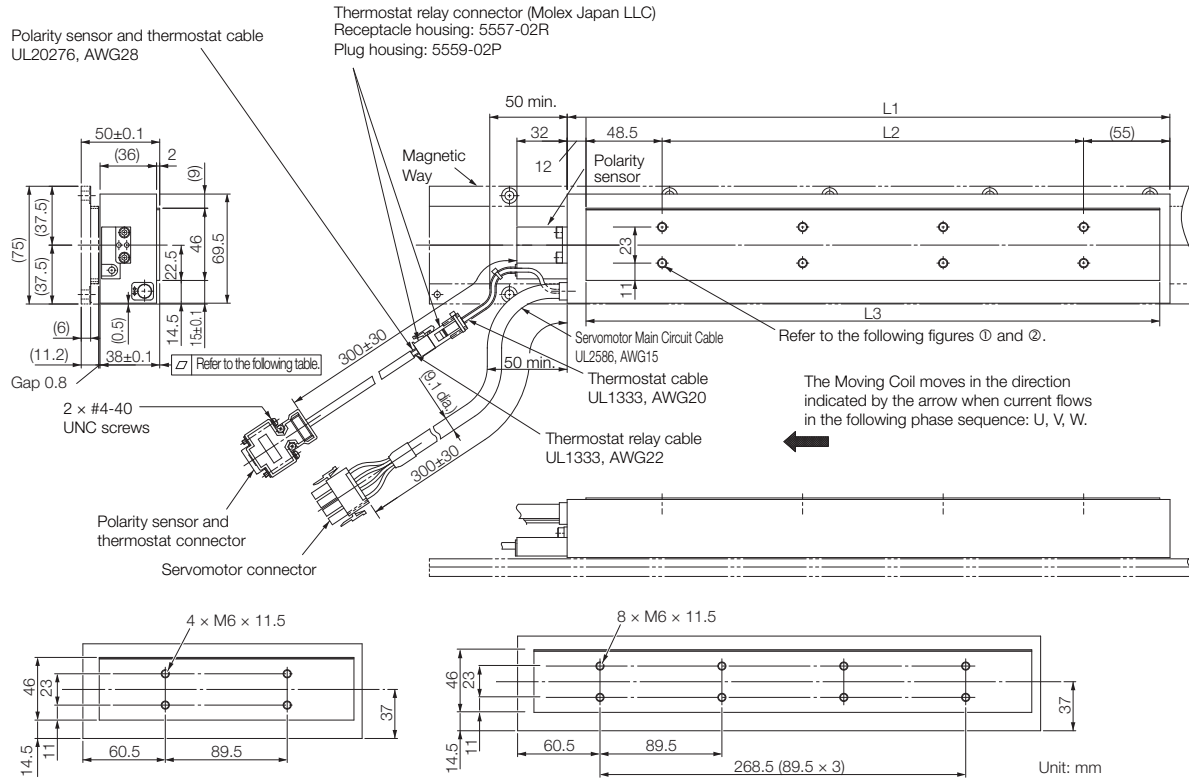

Moving Coil Model SGLFW2-	L1	L2	L3	Flatness	Approx. Mass [kg]
45A200AS	205	89.5	187	0.2	2.9
45A380AS	384	268.5	365.5	0.3	5.5

■ Connector Specifications

• Servomotor Connector

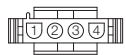

1	Phase U	Red
2	Phase V	White
3	Phase W	Black
4	FG	Green

Plug: 350779-1
Pins: 350218-3 or 350547-3 (No.1 to 3)
350654-1 or 350669-1 (No. 4)
From Tyco Electronics Japan G.K.

Mating Connector

Cap: 350780-1
Socket: 350536-3 or 350550-3

• Polarity Sensor and Thermostat Connector

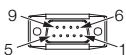

1	+5 V (thermal protector), +5 V (power supply)		
2	Su	6	Not used
3	Sv	7	
4	Sw	8	
5	0 V (power supply)	9	Thermal protector

Pin connector: 17JE-23090-02 (D8C) -CG
From DDK Ltd.

Mating Connector

Socket connector: 17JE-13090-02 (D8C) A-CG
Studs: 17L-002C or 17L-002C1

■ Polarity Sensor Output Signal

The figure on the right shows the relationship between the Su, Sv, and Sw polarity sensor output signals and the inverse power of each motor phase Vu, Vv, and Vw when the Moving Coil moves in the direction indicated by the arrow in the dimensional drawings of the Moving Coil.

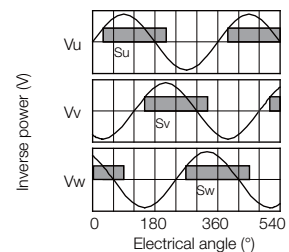

◆ Moving Coils without Polarity Sensors: SGLFW2-45A□□□AT

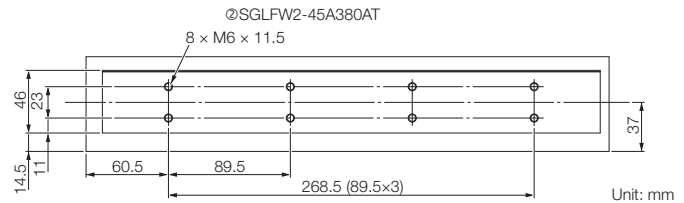
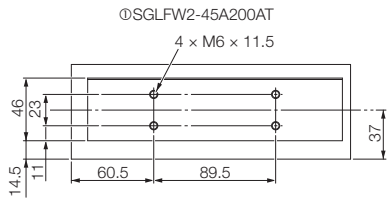
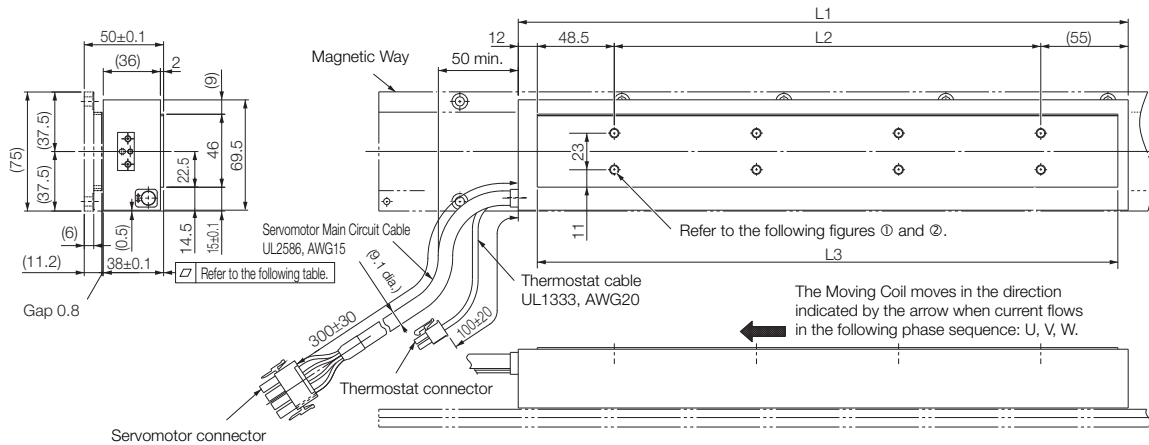

Moving Coil Model SGLFW2-	L1	L2	L3	Flatness	Approx. Mass [kg]
45A200AT	205	89.5	187	0.2	2.9
45A380AT	384	268.5	365.5	0.3	5.5

■ Connector Specifications

• Servomotor Connector



1	Phase U	Red
2	Phase V	White
3	Phase W	Black
4	FG	Green

Plug: 350779-1
Pins: 350218-3 or 350547-3 (No.1 to 3)
350654-1 or 350669-1 (No. 4)
From Tyco Electronics Japan G.K.

Mating Connector

Cap: 350780-1
Socket: 350536-3 or 350550-3

• Thermostat Connector



1	Thermal protector
2	Thermal protector

Receptacle housing: 5557-02R
Terminals: 5556T or 5556TL
From Molex Japan LLC

Mating Connector

Plug housing: 5559-02P
Terminals: 5558T or 5558TL

◆ Magnetic Ways: SGLFM2-45□□□A

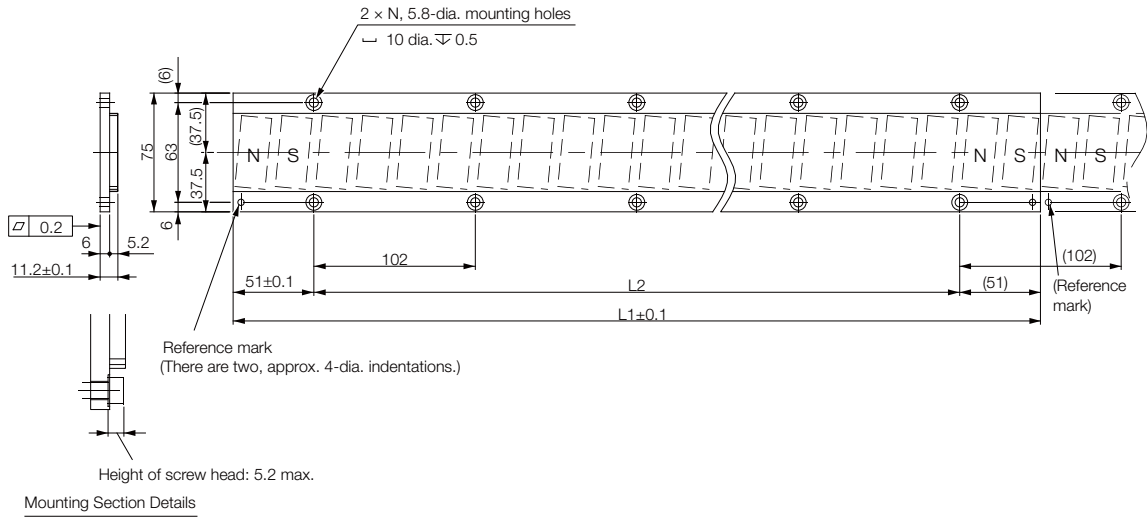

Unit: mm

Note: More than one Magnetic Way can be connected. Connect the Magnetic Ways so that the reference marks on them are aligned in the same direction as shown in the figure.

Magnetic Way Model SGLFM2-	L1 ± 0.1	L2	N	Approx. Mass [kg]
45306A	306	204 (102 × 2)	3	1.5
45510A	510	408 (102 × 4)	5	2.5
45714A	714	612 (102 × 6)	7	3.4

SGLFW2-90

◆ Moving Coils with Polarity Sensors: SGLFW2-90A□□□AS

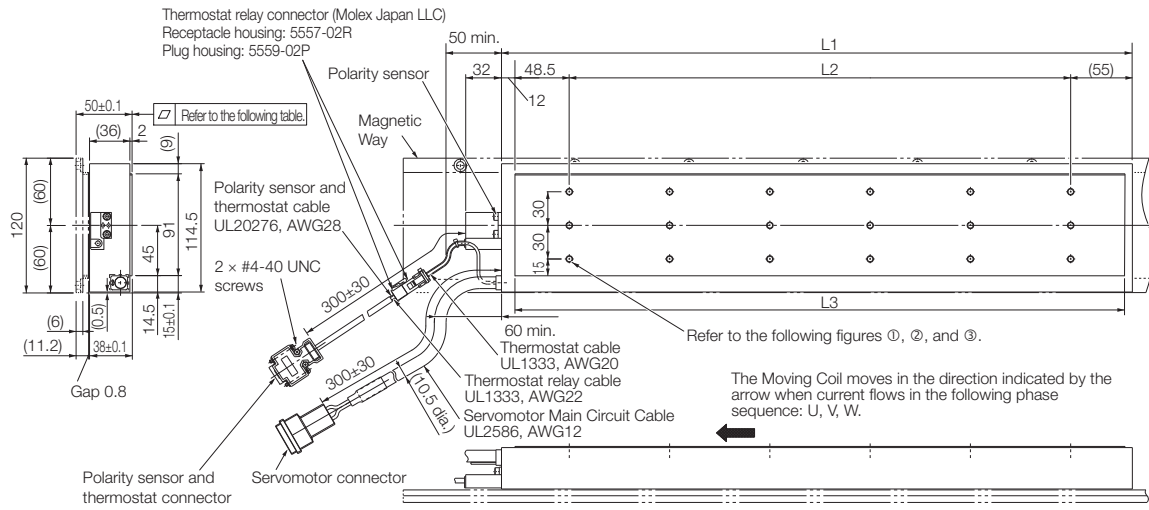

①SGLFW2-90A200AS

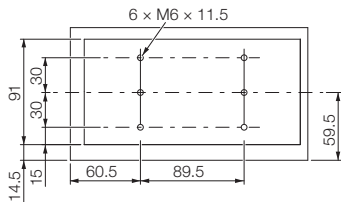

②SGLFW2-90A380AS

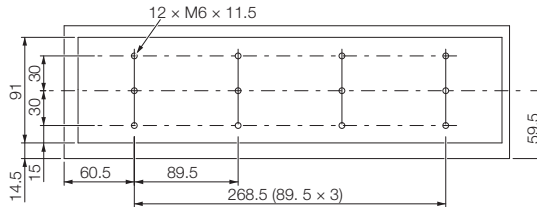

③SGLFW2-90A560AS

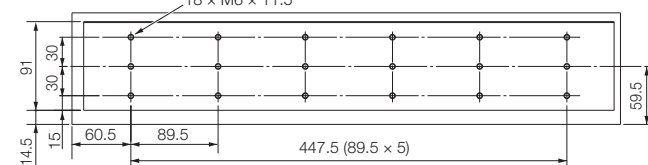

Unit: mm

Moving Coil Model SGLFW2-	L1	L2	L3	Flatness	Approx. Mass [kg]
90A200AS	205	89.5	187	0.2	5.3
90A380AS	384	268.5	365.5	0.3	10.1
90A560AS	563	447.5	544	0.3	14.9

■ Connector Specifications

• Servomotor Connector

B1	B2	A1	Phase U	Red
A1	A2	A2	Phase V	White
		B1	Phase W	Black
		B2	FG	Green

Tab housing: 1-917808-2
Contacts: 917803-2 (A1, A2, and B1)
84695-1 (B2)

From Tyco Electronics Japan G.K.

Mating Connector

Receptacle housing: 1-917807-2
Contacts: 179956-2

• Polarity Sensor and Thermostat Connector

9	6	1	+5 V (thermal protector), +5 V (power supply)		
		2	Su	6	
		3	Sv	7	
		4	Sw	8	
5	1	5	0 V (power supply)	9	
					Not used
					Thermal protector

Pin connector: 17JE-23090-02 (D8C) -CG
From DDK Ltd.

Mating Connector

Socket connector: 17JE-13090-02 (D8C) A-CG
Studs: 17L-002C or 17L-002C1

■ Polarity Sensor Output Signal

The figure on the right shows the relationship between the Su, Sv, and Sw polarity sensor output signals and the inverse power of each motor phase Vu, Vv, and Vw when the Moving Coil moves in the direction indicated by the arrow in the dimensional drawings of the Moving Coil.

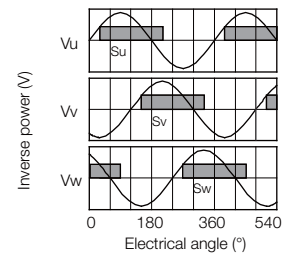

◆ Moving Coils without Polarity Sensors: SGLFW2-90A□□□AT

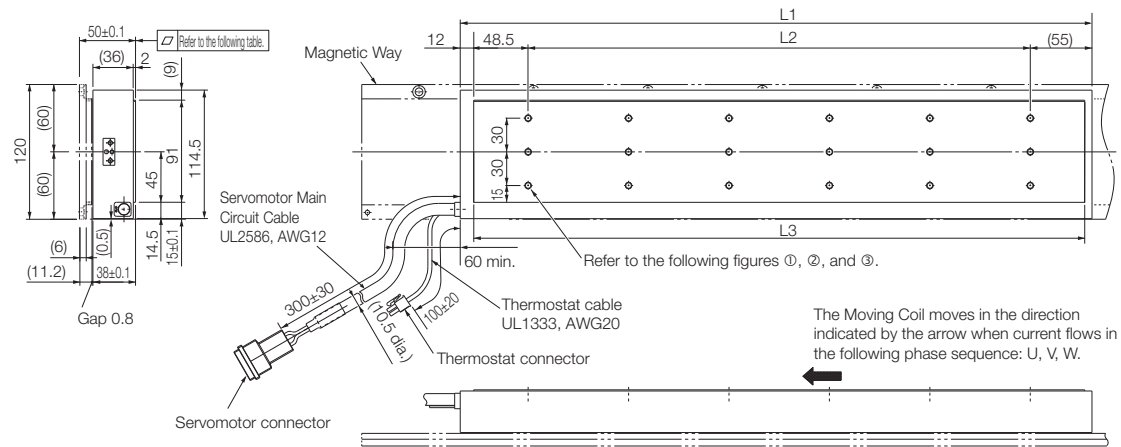

① SGLFW2-90A200AT

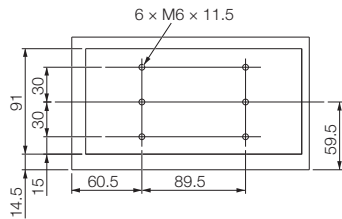

② SGLFW2-90A380AT

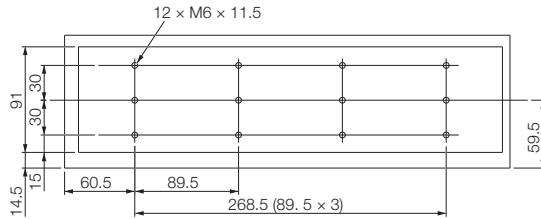

③ SGLFW2-90A560AT

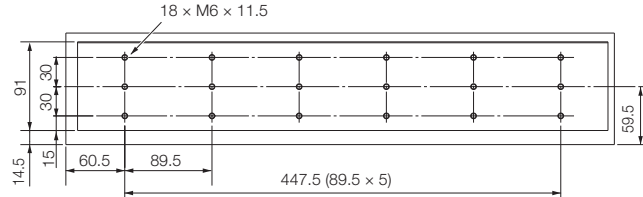

Unit: mm

Moving Coil Model SGLFW2-	L1	L2	L3	Flatness	Approx. Mass [kg]
90A200AT	205	89.5	187	0.2	5.3
90A380AT	384	268.5	365.5	0.3	10.1
90A560AT	563	447.5	544	0.3	14.9

■ Connector Specifications

• Servomotor Connector

	A1	Phase U	Red
	A2	Phase V	White
	B1	Phase W	Black
	B2	FG	Green

Tab housing: 1-917808-2
Contacts: 917803-2 (A1, A2, and B1)
84695-1 (B2)

From Tyco Electronics Japan G.K.

Mating Connector

Receptacle housing: 1-917807-2
Contacts: 179956-2

• Thermostat Connector

	1	Thermal protector
	2	Thermal protector

Receptacle housing: 5557-02R
Terminals: 5556T or 5556TL
From Molex Japan LLC

Mating Connector

Plug housing: 5559-02P
Terminals: 5558T or 5558TL

◆ Magnetic Ways: SGLFM2-90□□□A

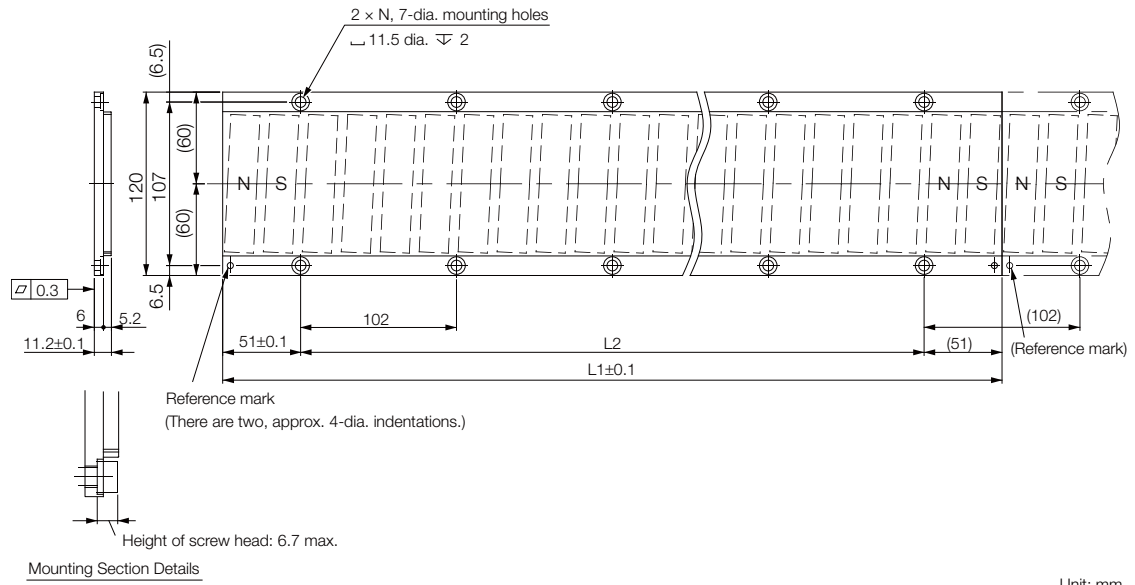

Note: More than one Magnetic Way can be connected. Connect the Magnetic Ways so that the reference marks on them are aligned in the same direction as shown in the figure.

Magnetic Way Model SGLFM2-	L1±0.1	L2	N	Approx. Mass [kg]
90306A	306	204 (102 × 2)	3	2.6
90510A	510	408 (102 × 4)	5	4.2
90714A	714	612 (102 × 6)	7	5.9

SGLFW2-1D

◆ Moving Coil with Polarity Sensor: SGLFW2-1DA□□□AS

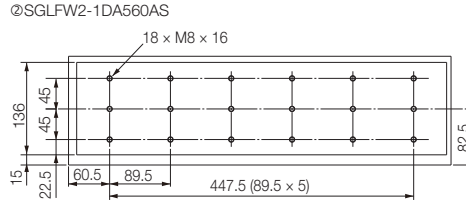
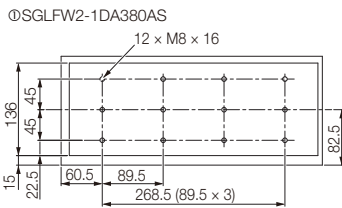
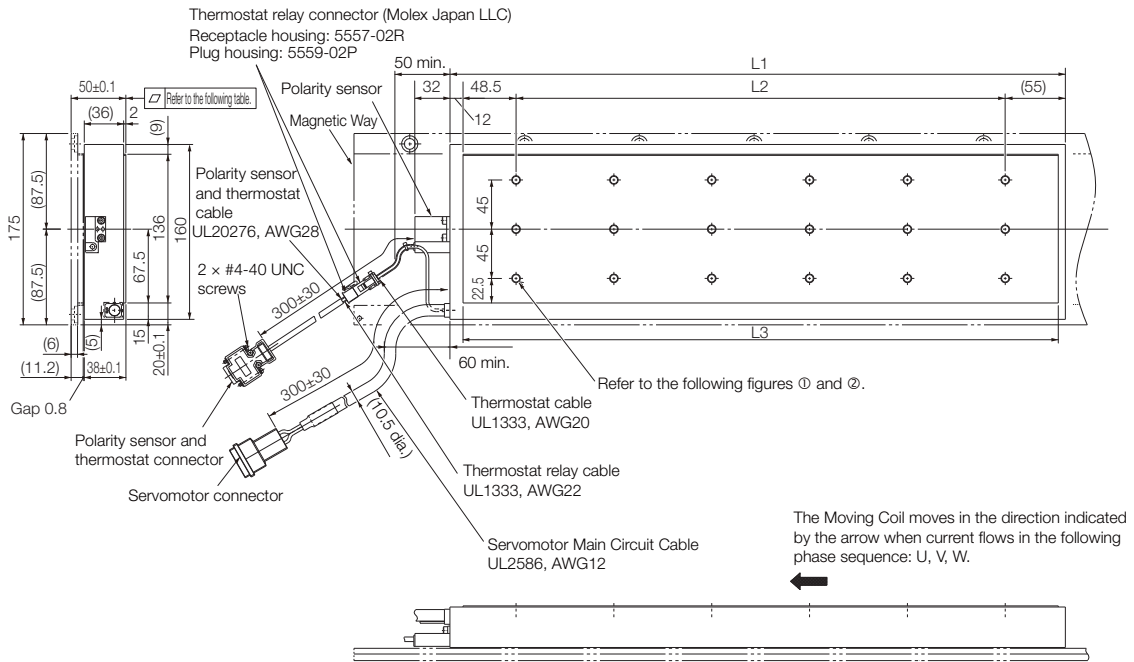

Unit: mm

Moving Coil Model SGLFW2-	L1	L2	L3	Flatness	Approx. Mass [kg]
1DA380AS	384	268.5	365.5	0.3	14.6
1DA560AS	563	447.5	544	0.3	21.5

■ Connector Specifications

• Servomotor Connector

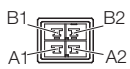

A1	Phase U	Red
A2	Phase V	White
B1	Phase W	Black
B2	FG	Green

Tab housing: 1-917808-2
Contacts: 917803-2 (A1, A2, and B1)
84695-1 (B2)

From Tyco Electronics Japan G.K.

Mating Connector

Receptacle housing: 1-917807-2
Contacts: 179956-2

• Polarity Sensor and Thermostat Connector

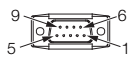

1	+5 V (thermal protector), +5 V (power supply)		
2	Su	6	Not used
3	Sv	7	
4	Sw	8	
5	0 V (power supply)	9	Thermal protector

Pin connector: 17JE-23090-02 (D8C) -CG
From DDK Ltd.

Mating Connector

Socket connector: 17JE-13090-02 (D8C) A-CG
Studs: 17L-002C or 17L-002C1

■ Polarity Sensor Output Signal

The figure on the right shows the relationship between the Su, Sv, and Sw polarity sensor output signals and the inverse power of each motor phase Vu, Vv, and Vw when the Moving Coil moves in the direction indicated by the arrow in the dimensional drawings of the Moving Coil.

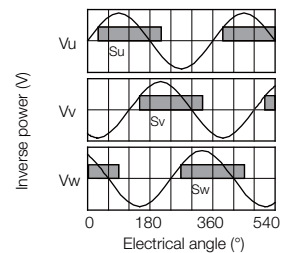

◆ Moving Coil without Polarity Sensor: SGLFW2-1DA□□□AT

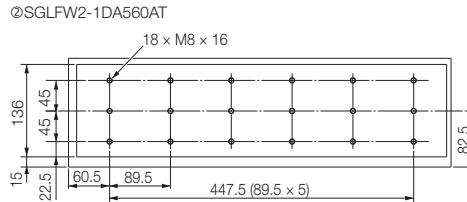
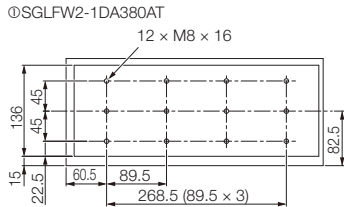
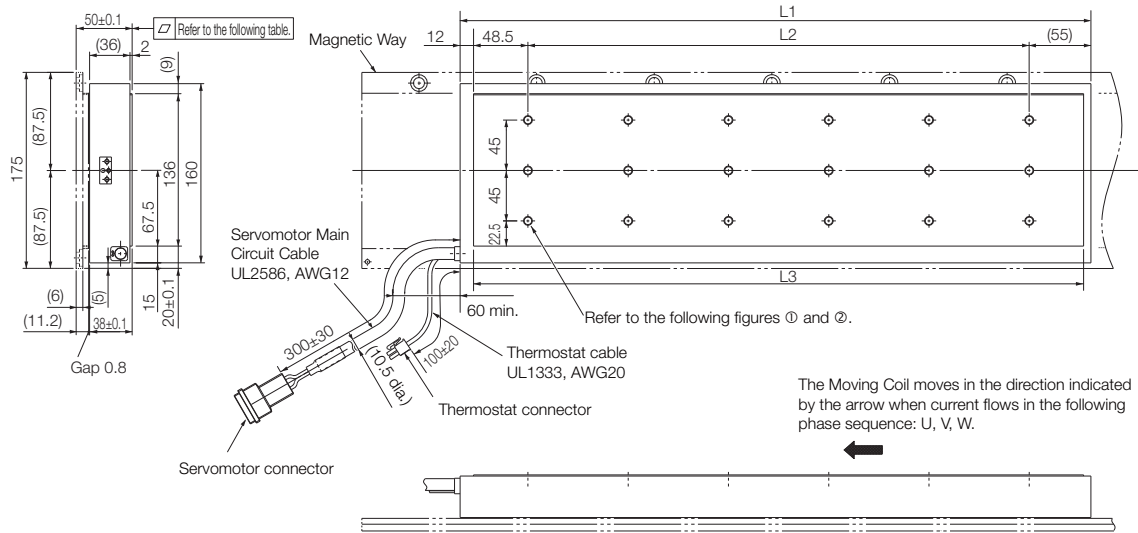

Unit: mm

Moving Coil Model SGLFW2-	L1	L2	L3	Flatness	Approx. Mass [kg]
1DA380AT	384	268.5	365.5	0.3	14.6
1DA560AT	563	447.5	544	0.3	21.5

■ Connector Specifications

• Servomotor Connector

B1	A1	Phase U	Red
B2	A2	Phase V	White
A1	B1	Phase W	Black
A2	B2	FG	Green

Tab housing: 1-917808-2
Contacts: 917803-2 (A1, A2, and B1)
84695-1 (B2)

From Tyco Electronics Japan G.K.

Mating Connector

Receptacle housing: 1-917807-2
Contacts: 179956-2

• Thermostat Connector

1	Thermal protector
2	Thermal protector

Receptacle housing: 5557-02R
Terminals: 5556T or 5556TL
From Molex Japan LLC

Mating Connector

Plug housing: 5559-02P
Terminals: 5558T or 5558TL

◆ Magnetic Ways: SGLFM2-1D□□□A

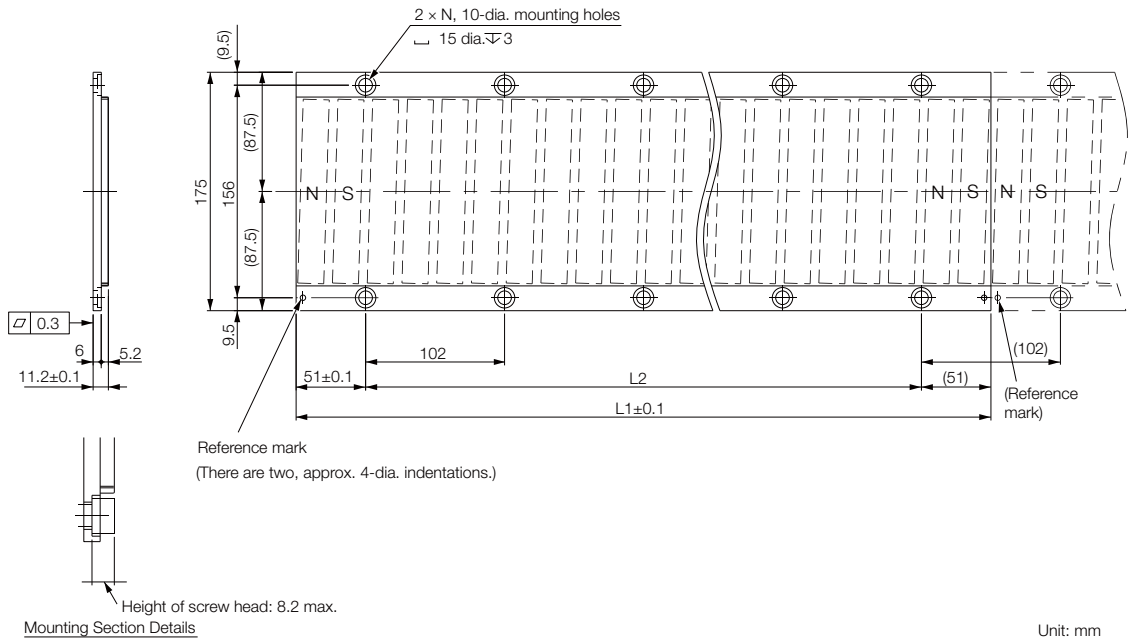

Note: More than one Magnetic Way can be connected. Connect the Magnetic Ways so that the reference marks on them are aligned in the same direction as shown in the figure.

Magnetic Way Model SGLFM2-	L1±0.1	L2	N	Approx. Mass [kg]
1D306A	306	204 (102 × 2)	3	3.7
1D510A	510	408 (102 × 4)	5	6.2
1D714A	714	612 (102 × 6)	7	8.6

SGLFW-20

◆ Moving Coils: SGLFW-20A□□□A□

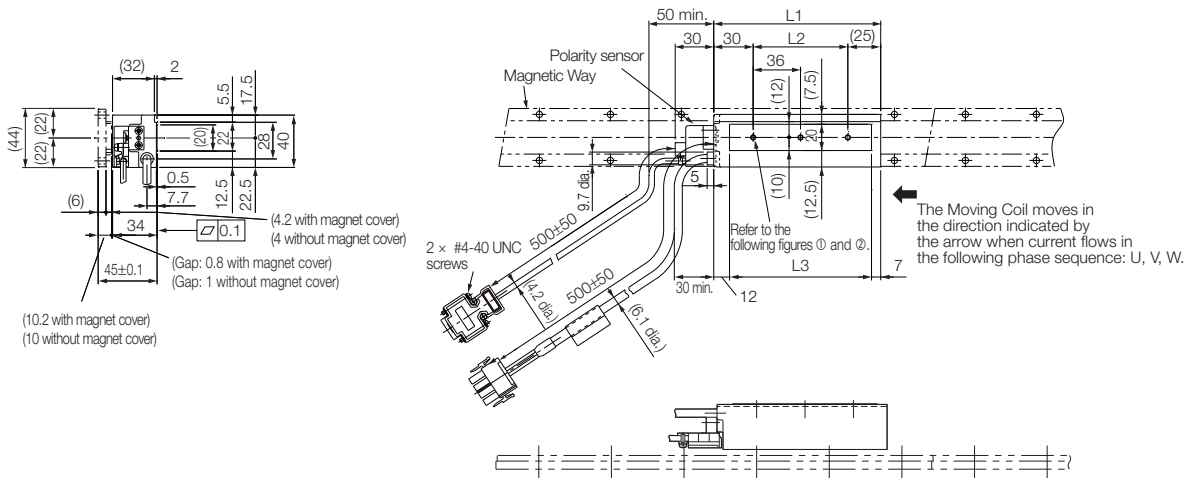

① SGLFW-20A090A□

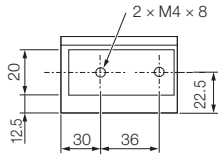

② SGLFW-20A120A□

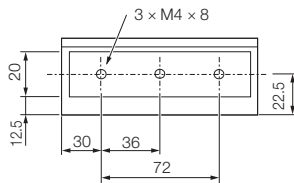

Unit: mm

Moving Coil Model SGLFW-	L1	L2	L3	Approx. Mass [kg]
20A090A□	91	36	72	0.7
20A120A□	127	72	108	0.9

Note: The above dimensional drawing gives the dimensions for both models with polarity sensors and models without polarity sensors.

■ Connector Specifications

• Servomotor Connector



1	Phase U	Red
2	Phase V	White
3	Phase W	Black
4	FG	Green

Plug: 350779-1

Pins: 350218-3 or 350547-3 (No.1 to 3)

350654-1 or 350669-1 (No. 4)

From Tyco Electronics Japan G.K.

Mating Connector

Cap: 350780-1

Socket: 350536-3 or 350550-3

• Polarity Sensor Connector

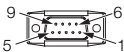

1	+5 V (thermal protector), +5 V (power supply)		
2	Su	6	Not used
3	Sv	7	
4	Sw	8	
5	0 V (power supply)	9	Thermal protector

Pin connector: 17JE-23090-02 (D8C) -CG

From DDK Ltd.

Mating Connector

Socket connector: 17JE-13090-02 (D8C) A-CG

Studs: 17L-002C or 17L-002C1

■ Polarity Sensor Output Signal

The figure on the right shows the relationship between the Su, Sv, and Sw polarity sensor output signals and the inverse power of each motor phase Vu, Vv, and Vw when the Moving Coil moves in the direction indicated by the arrow in the dimensional drawings of the Moving Coil.

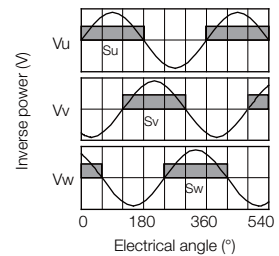

◆ Magnetic Ways: SGLFM-20□□□A

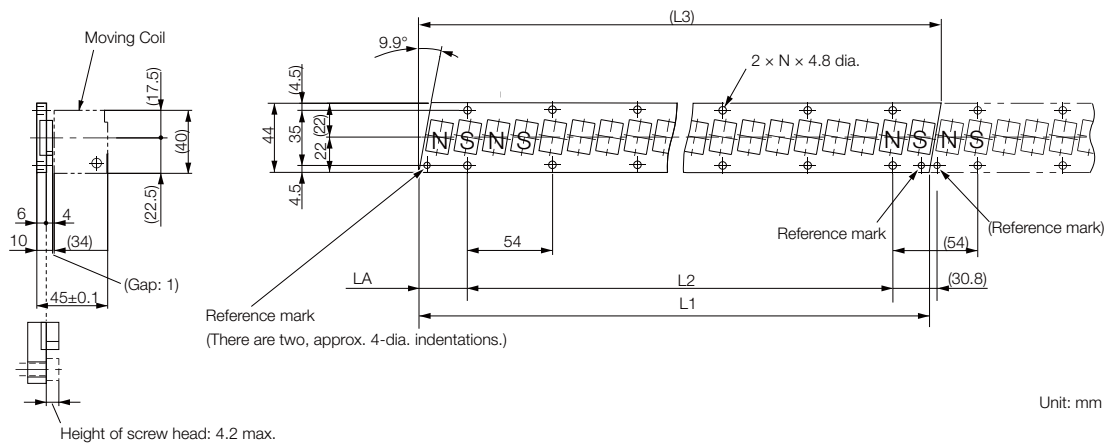

Note: More than one Magnetic Way can be connected. Connect the Magnetic Ways so that the reference marks on them are aligned in the same direction as shown in the figure.

Magnetic Way Model SGLFM-	L1	L2	(L3)	LA	N	Approx. Mass [kg]
20324A	324 ^{-0.1} _{-0.3}	270 (54 × 5)	(331.6)	30.8 ⁰ _{-0.2}	6	0.9
20540A	540 ^{-0.1} _{-0.3}	486 (54 × 9)	(547.6)	30.8 ⁰ _{-0.2}	10	1.4
20756A	756 ^{-0.1} _{-0.3}	702 (54 × 13)	(763.6)	30.8 ⁰ _{-0.2}	14	2

SGLFW-35

◆ Moving Coils: SGLFW-35A□□□A□

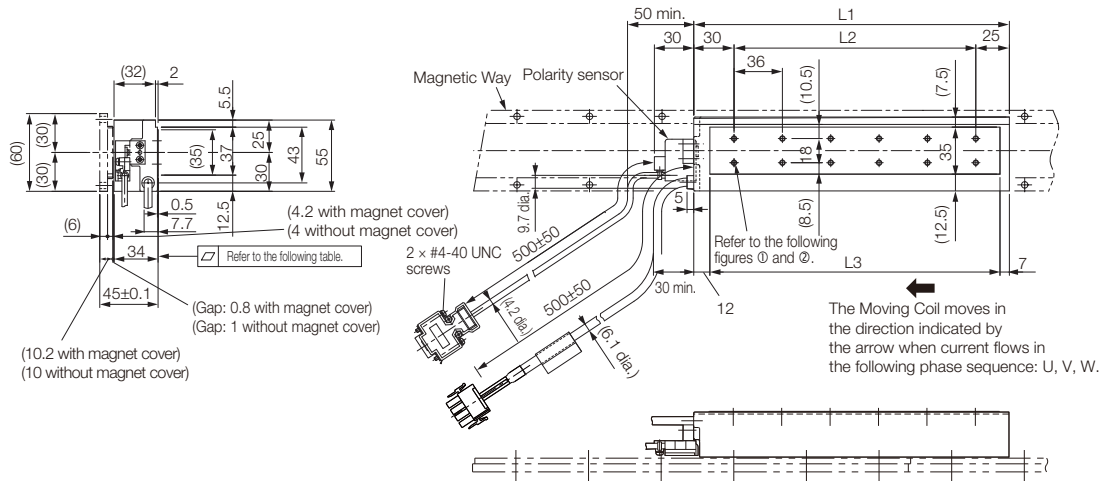

① SGLFW-35A120A□

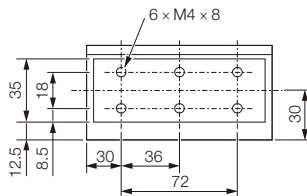

② SGLFW-35A230A□

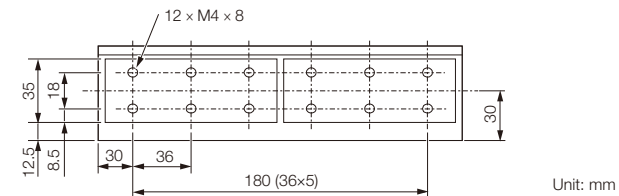

Moving Coil Model SGLFW-	L1	L2	L3	Approx. Mass [kg]
35A120A□	127	72	108	1.3
35A230A□	235	180	216	2.3

Note: The above dimensional drawing gives the dimensions for both models with polarity sensors and models without polarity sensors.

■ Connector Specifications

• Servomotor Connector

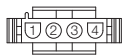

1	Phase U	Red
2	Phase V	White
3	Phase W	Black
4	FG	Green

Plug: 350779-1
Pins: 350218-3 or 350547-3 (No. 1 to 3)
350654-1 or 350669-1 (No. 4)
From Tyco Electronics Japan G.K.

Mating Connector

Cap: 350780-1
Socket: 350536-3 or 350550-3

• Polarity Sensor Connector

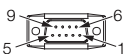

1	+5 V (thermal protector), +5 V (power supply)		
2	Su	6	Not used
3	Sv	7	
4	Sw	8	
5	0 V (power supply)	9	Thermal protector

Pin connector: 17JE-23090-02 (D8C) -CG
From DDK Ltd.

Mating Connector

Socket connector: 17JE-13090-02 (D8C) A-CG
Studs: 17L-002C or 17L-002C1

■ Polarity Sensor Output Signal

The figure on the right shows the relationship between the Su, Sv, and Sw polarity sensor output signals and the inverse power of each motor phase Vu, Vv, and Vw when the Moving Coil moves in the direction indicated by the arrow in the dimensional drawings of the Moving Coil.

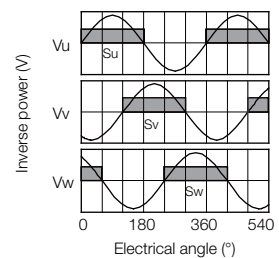

◆ **Moving Coils: SGLFW-35A□□□A□□**

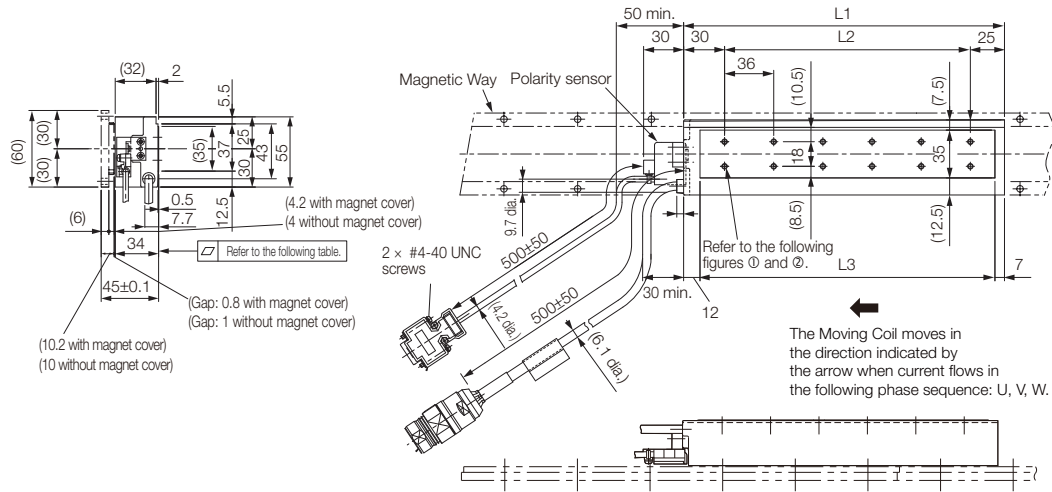

① SGLFW-35A120A□□

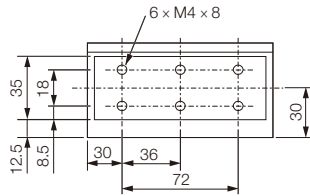

② SGLFW-35A230A□□

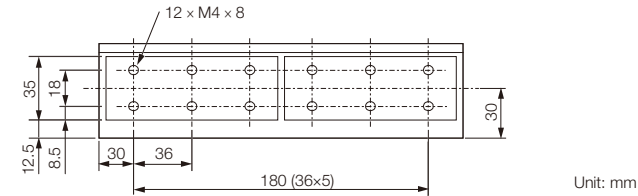

Moving Coil Model SGLFW-	L1	L2	L3	Approx. Mass [kg]
35A120A□□	127	72	108	1.3
35A230A□□	235	180	216	2.3

Note: The above dimensional drawing gives the dimensions for both models with polarity sensors and models without polarity sensors.

■ **Connector Specifications**

• **Servomotor Connector**



1	Phase U	5	Not used
2	Phase V	6	Not used
4	Phase W	⊕	Ground

Extension: ARRA06AMRPN182

Pins: 021.279.1020

From Interconnectron GmbH

Mating Connector

Plug: APRA06BFRDN170

Socket: 020.105.1020

• **Polarity Sensor Connector**

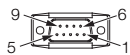

1	+5 V (power supply)	6	Not used
2	Phase U	7	
3	Phase V	8	
4	Phase W	9	
5	0 V (power supply)	-	

Pin connector: 17JE-23090-02 (D8C)-CG

From DDK Ltd.

Mating Connector

Socket connector: 17JE-13090-02 (D8C)A-CG

Studs: 17L-002C or 17L-002C1

■ **Polarity Sensor Output Signal**

The figure on the right shows the relationship between the Su, Sv, and Sw polarity sensor output signals and the inverse power of each motor phase Vu, Vv, and Vw when the Moving Coil moves in the direction indicated by the arrow in the dimensional drawings of the Moving Coil.

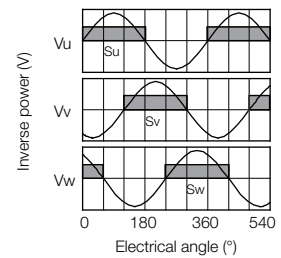

◆ Magnetic Ways: SGLFM-35□□□A

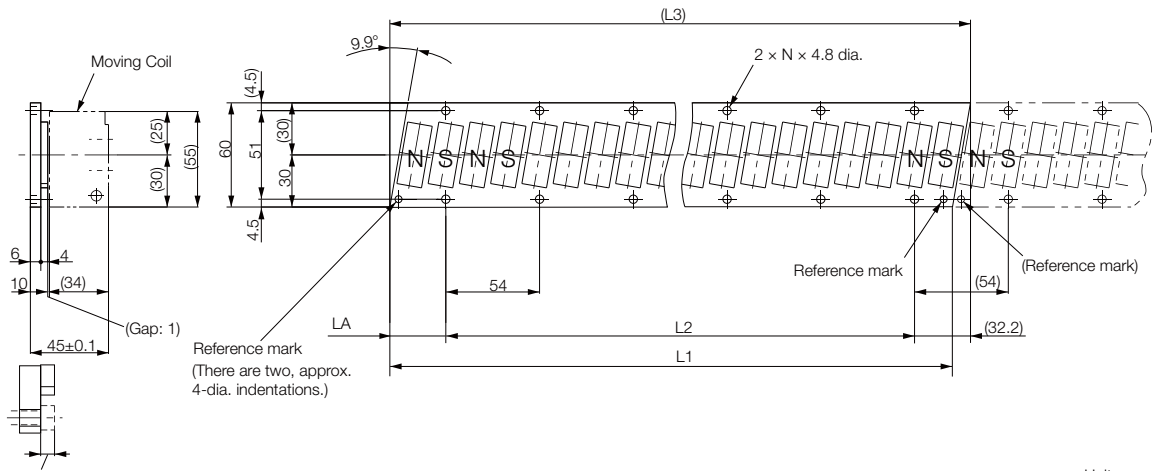

Mounting Section Details

Note: More than one Magnetic Way can be connected. Connect the Magnetic Ways so that the reference marks on them are aligned in the same direction as shown in the figure.

Magnetic Way Model SGLFM-	L1	L2	(L3)	LA	N	Approx. Mass [kg]
35324A	324 ^{-0.1} _{-0.3}	270 (54 × 5)	(334.4)	32.2 ⁰ _{-0.2}	6	1.2
35540A	540 ^{-0.1} _{-0.3}	486 (54 × 9)	(550.4)	32.2 ⁰ _{-0.2}	10	2
35756A	756 ^{-0.1} _{-0.3}	702 (54 × 13)	(766.4)	32.2 ⁰ _{-0.2}	14	2.9

SGLFW-50

◆ Moving Coils: SGLFW-50A□□□B□

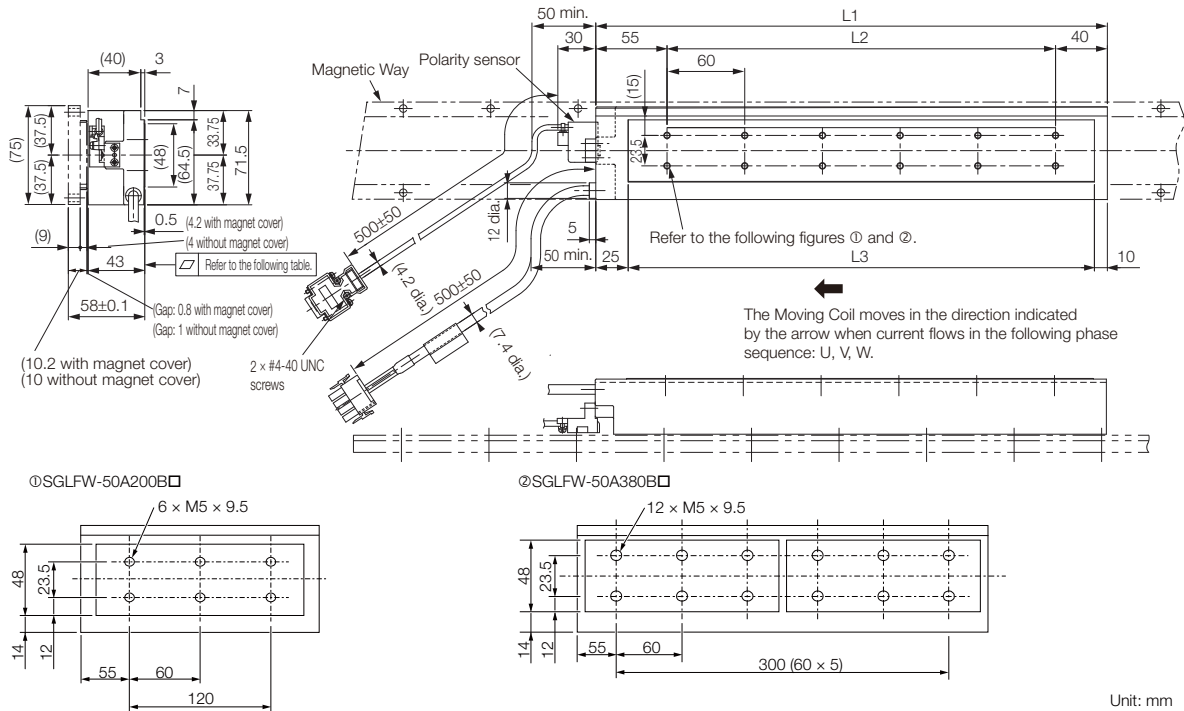

Moving Coil Model SGLFW-	L1	L2	L3	Approx. Mass [kg]
50A200B□	215	120	180	3.5
50A380B□	395	300	360	6.9

Note: The above dimensional drawing gives the dimensions for both models with polarity sensors and models without polarity sensors.

■ Connector Specifications

• Servomotor Connector

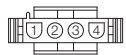

1	Phase U	Red
2	Phase V	White
3	Phase W	Black
4	FG	Green

Plug: 350779-1
Pins: 350218-3 or 350547-3 (No. 1 to 3)
350654-1 or 350669-1 (No. 4)
From Tyco Electronics Japan G.K.

Mating Connector

Cap: 350780-1
Socket: 350536-3 or 350550-3

• Polarity Sensor Connector

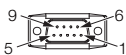

1	+5 V (thermal protector), +5 V (power supply)		
2	Su	6	Not used
3	Sv	7	
4	Sw	8	
5	0 V (power supply)	9	Thermal protector

Pin connector: 17JE-23090-02 (D8C) -CG
From DDK Ltd.

Mating Connector

Socket connector: 17JE-13090-02 (D8C) A-CG
Studs: 17L-002C or 17L-002C1

■ Polarity Sensor Output Signal

The figure on the right shows the relationship between the Su, Sv, and Sw polarity sensor output signals and the inverse power of each motor phase Vu, Vv, and Vw when the Moving Coil moves in the direction indicated by the arrow in the dimensional drawings of the Moving Coil.

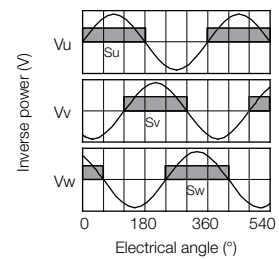

◆ Moving Coils: SGLFW-50A□□□B□□

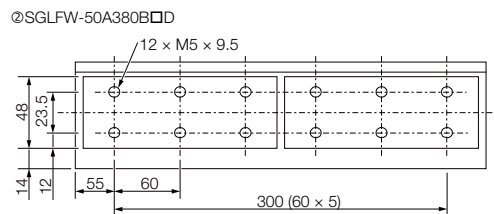
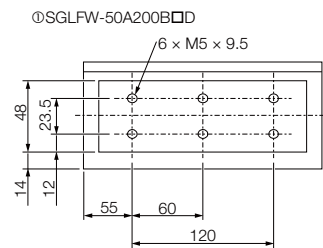
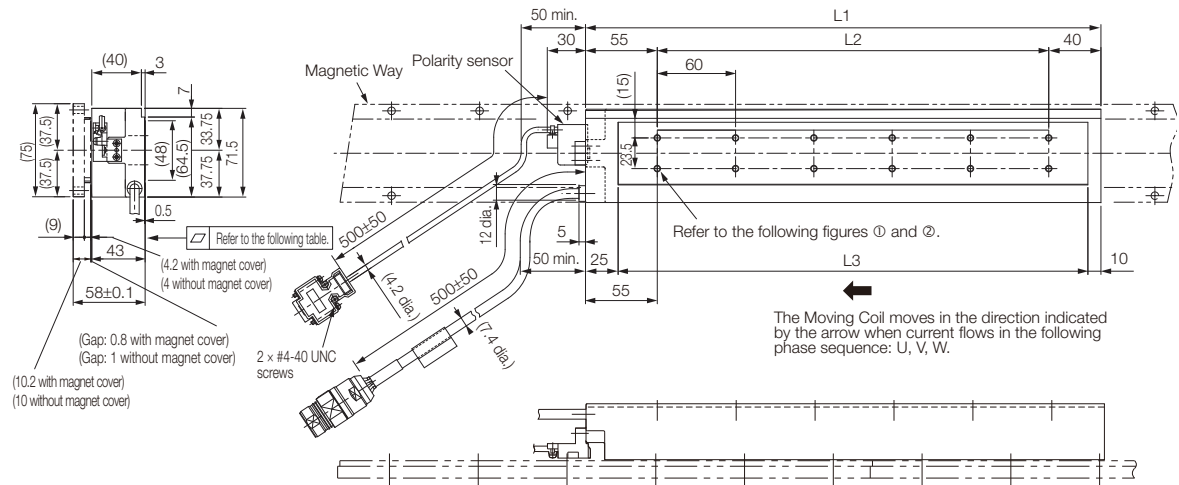

Unit: mm

Moving Coil Model SGLFW-	L1	L2	L3	Flatness	Approx. Mass [kg]
50A200B□□	215	120	180	0.2	3.5
50A380B□□	395	300	360	0.3	6.9

Note: The above dimensional drawing gives the dimensions for both models with polarity sensors and models without polarity sensors.

■ Connector Specifications

• Servomotor Connector



1	Phase U	5	Not used
2	Phase V	6	Not used
4	Phase W	⊕	Ground

Extension: ARRA06AMRPN182
Pins: 021.279.1020
From Interconnectron GmbH
Mating Connector
Plug: APRA06BFRDN170
Socket: 020.105.1020

• Polarity Sensor Connector

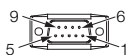

1	+5 V (power supply)	6	Not used
2	Phase U	7	
3	Phase V	8	
4	Phase W	9	
5	0 V (power supply)	-	-

Pin connector: 17JE-23090-02 (D8C)-CG
From DDK Ltd.
Mating Connector
Socket connector: 17JE-13090-02 (D8C)A-CG
Studs: 17L-002C or 17L-002C1

■ Polarity Sensor Output Signal

The figure on the right shows the relationship between the S_u , S_v , and S_w polarity sensor output signals and the inverse power of each motor phase V_u , V_v , and V_w when the Moving Coil moves in the direction indicated by the arrow in the dimensional drawings of the Moving Coil.

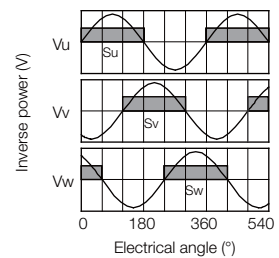

◆ Magnetic Ways: SGLFM-50□□□A

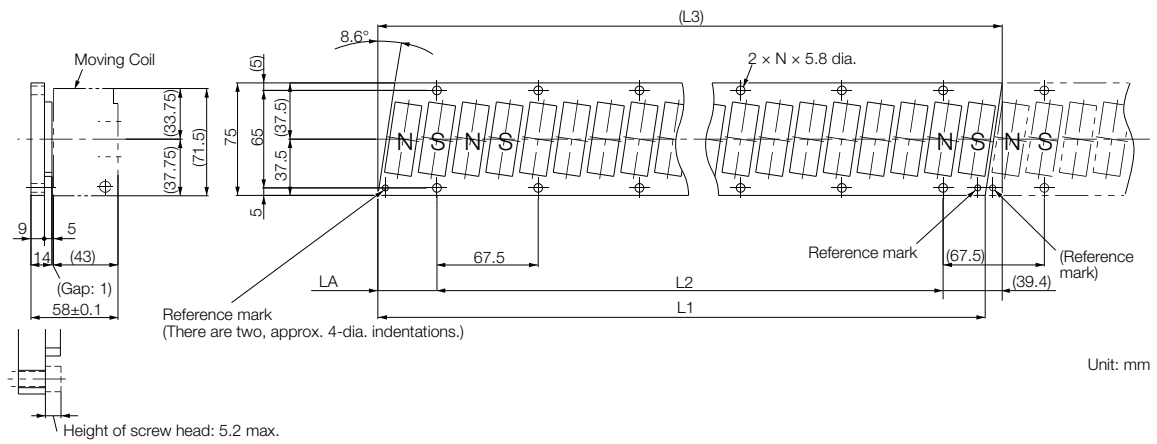

Note: More than one Magnetic Way can be connected. Connect the Magnetic Ways so that the reference marks on them are aligned in the same direction as shown in the figure.

Magnetic Way Model SGLFM-	L1	L2	(L3)	LA	N	Approx. Mass [kg]
50405A	405 ^{-0.1} _{-0.3}	337.5 (67.5 × 5)	(416.3)	39.4 ⁰ _{-0.2}	6	2.8
50675A	675 ^{-0.1} _{-0.3}	607.5 (67.5 × 9)	(686.3)	39.4 ⁰ _{-0.2}	10	4.6
50945A	945 ^{-0.1} _{-0.3}	877.5 (67.5 × 13)	(956.3)	39.4 ⁰ _{-0.2}	14	6.5

SGLFW-1Z

◆ Moving Coils: SGLFW-1ZA□□□□B□

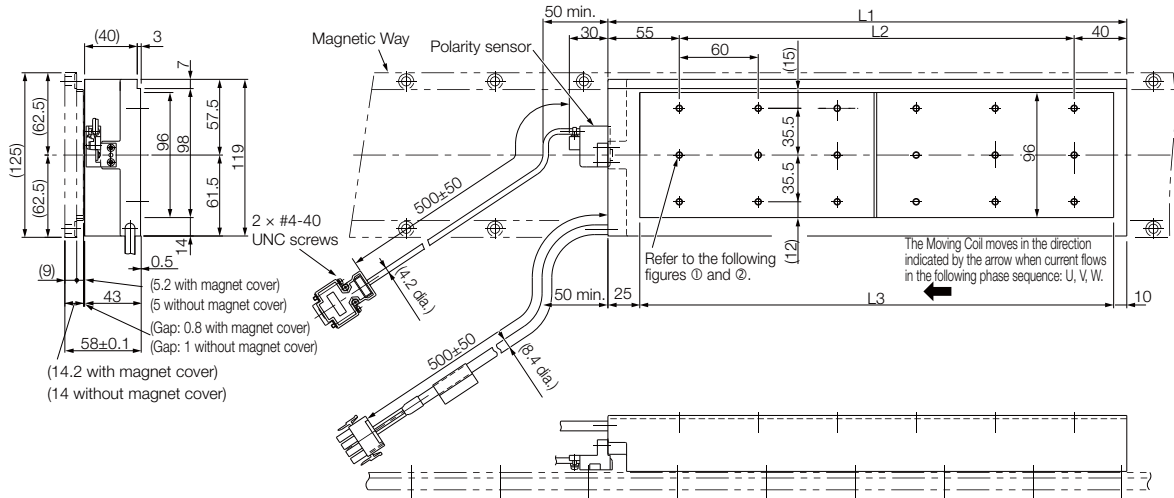

①SGLFW-1ZA200B□

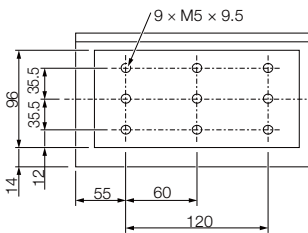

②SGLFW-1ZA380B□

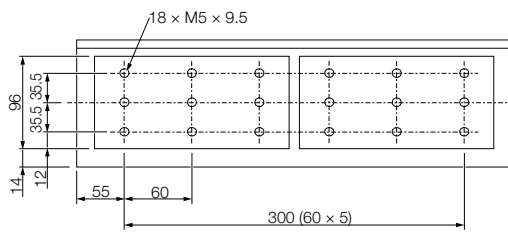

Unit: mm

Moving Coil Model SGLFW-	L1	L2	L3	Approx. Mass [kg]
1ZA200B□	215	120	180	6.4
1ZA380B□	395	300	360	11.5

Note: The above dimensional drawing gives the dimensions for both models with polarity sensors and models without polarity sensors.

■ Connector Specifications

• Servomotor Connector

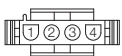

1	Phase U	Red
2	Phase V	White
3	Phase W	Black
4	FG	Green

Plug: 350779-1
 Pins: 350218-3 or 350547-3 (No.1 to 3)
 350654-1 or 350669-1 (No. 4)
 From Tyco Electronics Japan G.K.

Mating Connector

Cap: 350780-1
 Socket: 350536-3 or 350550-3

• Polarity Sensor Connector

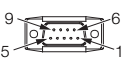

1	+5 V (power supply)	6	Not used
2	Phase U	7	
3	Phase V	8	
4	Phase W	9	
5	0 V (power supply)	-	-

Pin connector: 17JE-23090-02 (D8C)-CG
 From DDK Ltd.

Mating Connector

Socket connector: 17JE-13090-02 (D8C)A-CG
 Studs: 17L-002C or 17L-002C1

■ Polarity Sensor Output Signal

The figure on the right shows the relationship between the S_u , S_v , and S_w polarity sensor output signals and the inverse power of each motor phase V_u , V_v , and V_w when the Moving Coil moves in the direction indicated by the arrow in the dimensional drawings of the Moving Coil.

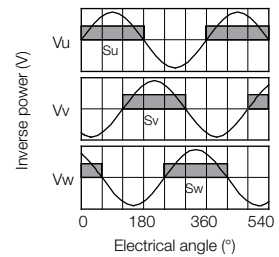

◆ Moving Coils: SGLFW-1ZA200B□D

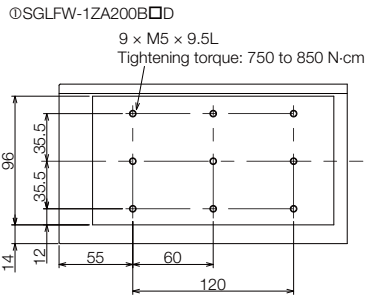
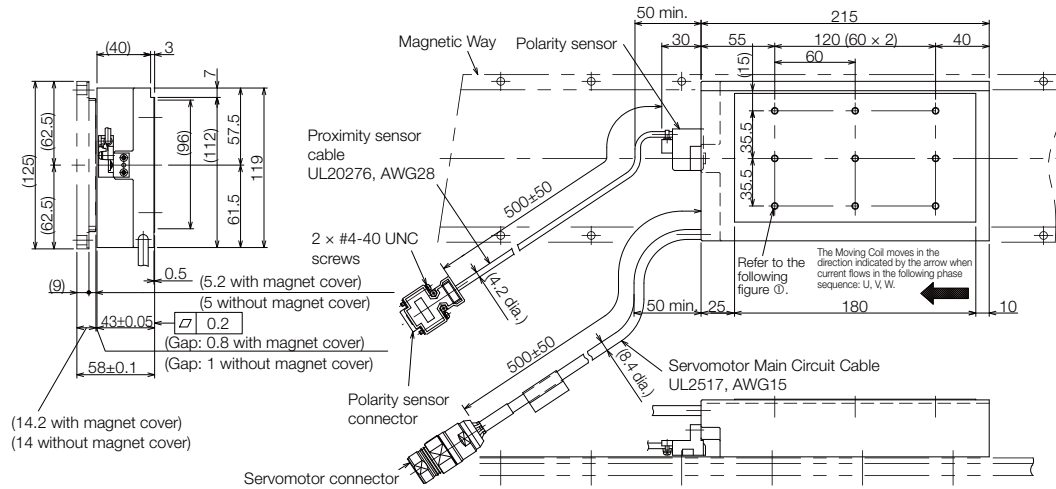

Approx. mass: 6.4 kg
Unit: mm

Note: The above dimensional drawing gives the dimensions for both models with polarity sensors and models without polarity sensors.

■ Connector Specifications

• Servomotor Connector

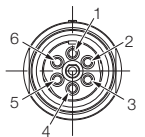

1	Phase U	4	Not used
2	Phase V	5	Not used
3	Phase W	6	Ground

Extension: SROC06JM5CN169
Pins: 021.423.1020
From Interconnectron GmbH
Mating Connector
Plug: SPUC06KFSDN236
Socket: 020.030.1020

• Polarity Sensor Connector

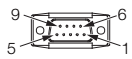

1	+5 V (power supply)	6	Not used
2	Phase U	7	
3	Phase V	8	
4	Phase W	9	
5	0 V (power supply)	-	

Pin connector: 17JE-23090-02 (D8C)-CG
From DDK Ltd.

Mating Connector

Socket connector: 17JE-13090-02 (D8C)A-CG
Studs: 17L-002C or 17L-002C1

■ Polarity Sensor Output Signal

The figure on the right shows the relationship between the Su, Sv, and Sw polarity sensor output signals and the inverse power of each motor phase Vu, Vv, and Vw when the Moving Coil moves in the direction indicated by the arrow in the dimensional drawings of the Moving Coil.

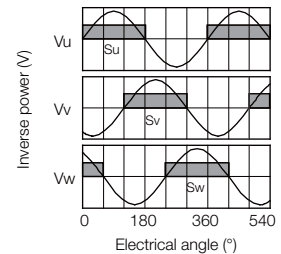

◆ Magnetic Ways: SGLFM-1Z□□□A

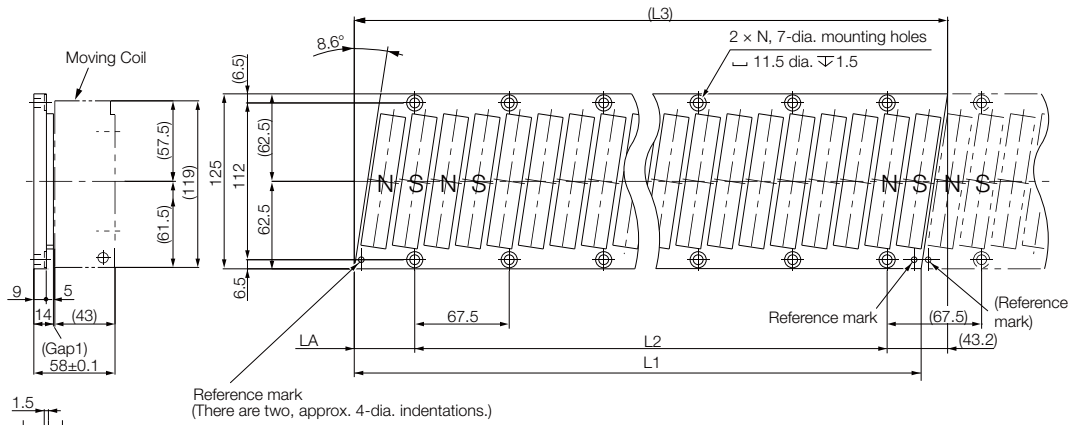

Height of screw head: 6.7 max.

Mounting Section Details

Unit: mm

Note: More than one Magnetic Way can be connected. Connect the Magnetic Ways so that the reference marks on them are aligned in the same direction as shown in the figure.

Magnetic Way Model SGLFM-	L1	L2	(L3)	LA	N	Approx. Mass [kg]
1Z405A	405 ^{-0.1} _{-0.3}	337.5 (67.5 × 5)	(423.9)	43.2 ⁰ _{-0.2}	6	5
1Z675A	675 ^{-0.1} _{-0.3}	607.5 (67.5 × 9)	(693.9)	43.2 ⁰ _{-0.2}	10	8.3
1Z945A	945 ^{-0.1} _{-0.3}	877.5 (67.5 × 13)	(963.9)	43.2 ⁰ _{-0.2}	14	12

Selecting Cables

◆ Cable Configurations

To select a Linear Encoder, use *Recommended Linear Encoders* (pages 308 and 309). Prepare the cable required for the encoder.

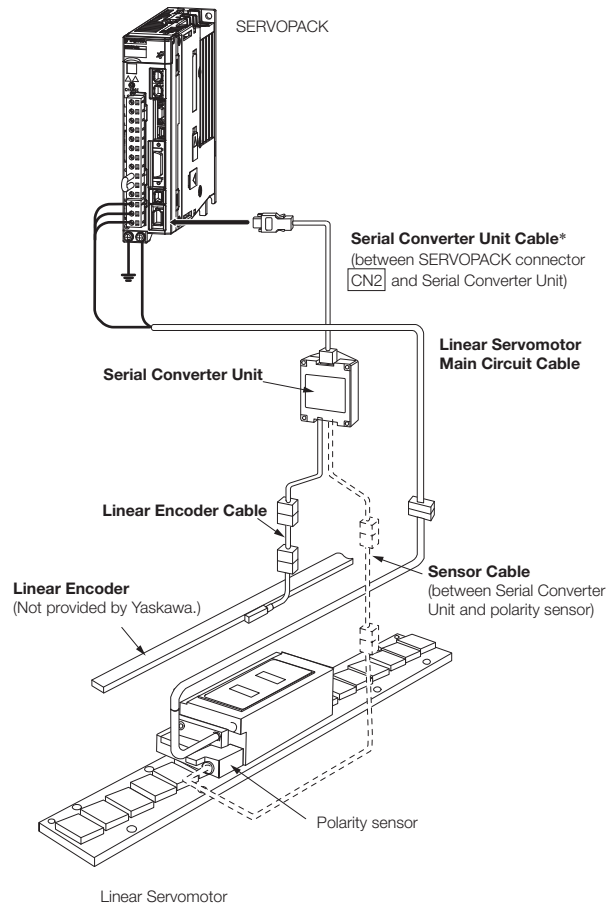

* You can connect directly to an absolute linear encoder.

Note: Refer to the following manual for the following information.

- Cable dimensional drawings and cable connection specifications
- Order numbers and specifications of individual connectors for cables
- Order numbers and specifications for wiring materials

📖 *Σ-7-Series AC Servo Drive Peripheral Device Selection Manual (Manual No.: SIEP S800001 32)*

◆ Linear Servomotor Main Circuit Cables

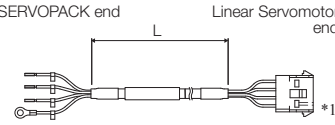
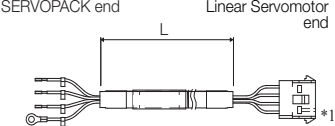
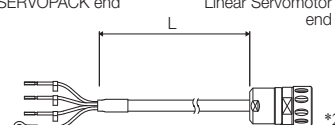
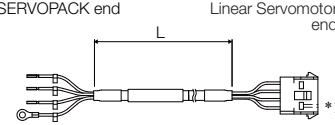
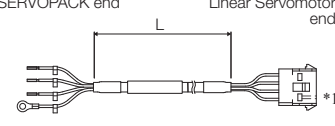
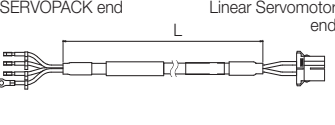
Linear Servomotor Model	Length (L)	Order Number	Appearance
SGLFW-20A, -35A	1 m	JZSP-CLN11-01-E	
	3 m	JZSP-CLN11-03-E	
	5 m	JZSP-CLN11-05-E	
	10 m	JZSP-CLN11-10-E	
	15 m	JZSP-CLN11-15-E	
	20 m	JZSP-CLN11-20-E	
SGLFW-50A, -1ZA	1 m	JZSP-CLN21-01-E	
	3 m	JZSP-CLN21-03-E	
	5 m	JZSP-CLN21-05-E	
	10 m	JZSP-CLN21-10-E	
	15 m	JZSP-CLN21-15-E	
SGLFW-□□A□□□□□D	1 m	JZSP-CLN14-01-E	
	3 m	JZSP-CLN14-03-E	
	5 m	JZSP-CLN14-05-E	
	10 m	JZSP-CLN14-10-E	
	15 m	JZSP-CLN14-15-E	
	20 m	JZSP-CLN14-20-E	
SGLFW2-30A070A□ SGLFW2-30A120A□ SGLFW2-30A230A□	1 m	JZSP-CL2N703-01-E	
	3 m	JZSP-CL2N703-03-E	
	5 m	JZSP-CL2N703-05-E	
	10 m	JZSP-CL2N703-10-E	
	15 m	JZSP-CL2N703-15-E	
	20 m	JZSP-CL2N703-20-E	
SGLFW2-45A200A□ SGLFW2-45A380A□	1 m	JZSP-CL2N603-01-E	
	3 m	JZSP-CL2N603-03-E	
	5 m	JZSP-CL2N603-05-E	
	10 m	JZSP-CL2N603-10-E	
	15 m	JZSP-CL2N603-15-E	
	20 m	JZSP-CL2N603-20-E	
SGLFW2-90A200A□ SGLFW2-90A380A□ SGLFW2-90A560A□ SGLFW2-1DA380A□ SGLFW2-1DA560A□	1 m	JZSP-CL2N503-01-E	
	3 m	JZSP-CL2N503-03-E	
	5 m	JZSP-CL2N503-05-E	
	10 m	JZSP-CL2N503-10-E	
	15 m	JZSP-CL2N503-15-E	
	20 m	JZSP-CL2N503-20-E	

Note: Estimates are available for models other than those listed above (SGLFW2-90A□□□□□L and SGLFW2-1D□□□□□L).

*1. Connector from Tyco Electronics Japan G.K.

*2. Connector from Interconnectron GmbH

SGLT (Models with T-type Iron Cores)

Model Designations

Moving Coil



1st digit Servomotor Type

Code	Specification
T	With T-type iron core

2nd digit Moving Coil/Magnetic Way

Code	Specification
W	Moving Coil

3rd+4th digits Magnet Height

Code	Specification
20	20 mm
35	36 mm
40	40 mm
50	51 mm
80	76.5 mm

5th digit Power Supply Voltage

Code	Specification
A	200 VAC

6th+7th+8th digits Length of Moving Coil

Code	Specification
170	170 mm
320	315 mm
400	394.2 mm
460	460 mm
600	574.2 mm

9th digit Design Revision Order

A, B ...
H: High-efficiency model

10th digit Sensor Specification and Cooling Method

Code	Specifications		Applicable Models
	Polarity Sensor	Cooling Method	
None	None	Self-cooled	All models
C*	None	Water-cooled	SGLTW-40, -80
H*	Yes	Water-cooled	
P	Yes	Self-cooled	All models

11th digit Connector for Servomotor Main Circuit Cable

Code	Specification	Applicable Models
None	Connector from Tyco Electronics Japan G.K.	SGLTW-20A□□□□□□, -35A□□□□□□
	MS connector	SGLTW-40A□□□□B□, -80A□□□□B□
	Loose lead wires with no connector	SGLTW-35A□□□□H□, -50A□□□□H□

* Contact your Yaskawa representative for the characteristics, dimensions, and other details on Servomotors with these specifications.

Note: This information is provided to explain model numbers. It is not meant to imply that models are available for all combinations of codes.

Magnetic Way



1st digit Servomotor Type

(Same as for the Moving Coil.)

2nd digit Moving Coil/Magnetic Way

Code	Specification
M	Magnetic Way

3rd+4th digits Magnet Height

(Same as for the Moving Coil.)

5th+6th+7th digits Length of Magnetic Way

Code	Specification
324	324 mm
405	405 mm
540	540 mm
675	675 mm
756	756 mm
945	945 mm

8th digit Design Revision Order

A, B ...
H: High-efficiency model

9th digit Options

Code	Specification	Applicable Models
None	Without options	-
C	With magnet cover	All models
Y	With base and magnet cover	SGLTM-20, -35*, -40, -80

* The SGLTM-35□□□□H (high-efficiency models) do not support this specification.

Note: This information is provided to explain model numbers. It is not meant to imply that models are available for all combinations of codes.

Precautions on Moving Coils with Polarity Sensors



Note

When you use a Moving Coil with a Polarity Sensor, the Magnetic Way must cover the bottom of the polarity sensor. Refer to the example that shows the correct installation. When determining the length of the Moving Coil's stroke or the length of the Magnetic Way, consider the total length of the Moving Coil and the polarity sensor. Refer to the following table.

Correct Installation

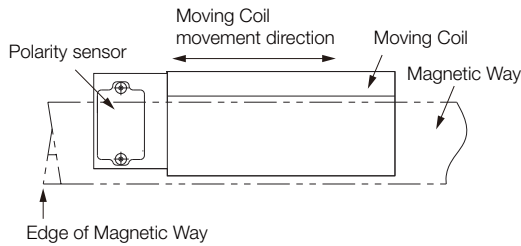

Incorrect Installation

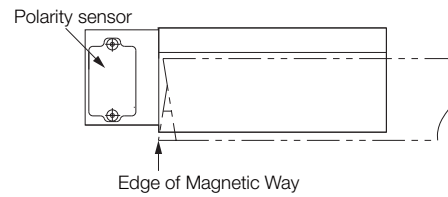

◆ Total Length of Moving Coil with Polarity Sensor

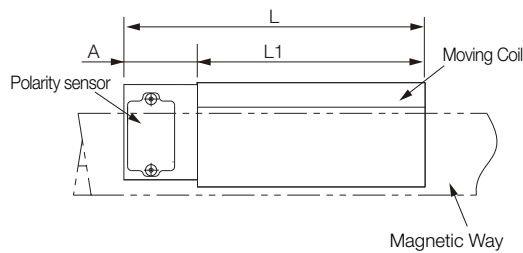

Moving Coil Model SGLTW-	Length of Moving Coil, L1 [mm]	Length of Polarity Sensor, A [mm]	Total Length, L [mm]
20A170AP□	170	34	204
20A320AP□	315		349
20A460AP□	460		494
35A170AP□	170	34	204
35A320AP□	315		349
35A460AP□	460		494
35A170HP□	170	34	204
35A320HP□	315		349
50A170HP□	170	34	204
50A320HP□	315		349
40A400BH□	394.2	26	420.2
40A400BP□			
40A600BH□	574.2	26	600.2
40A600BP□			
80A400BH□	394.2	26	420.2
80A400BP□			
80A600BH□	574.2	26	600.2
80A600BP□			

Specifications and Ratings

Specifications

Linear Servomotor Moving Coil Model SGLTW-		Standard Models										High-efficiency Models			
		20A			35A			40A		80A		35A		50A	
		170A	320A	460A	170A	320A	460A	400B	600B	400B	600B	170H	320H	170H	320H
Time Rating		Continuous													
Thermal Class		B													
Insulation Resistance		500 VDC, 10 MΩ min.													
Withstand Voltage		1,500 VAC for 1 minute													
Excitation		Permanent magnet													
Cooling Method		Self-cooled													
Protective Structure		IP00													
Envi- ron- men- tal Condi- tions	Surrounding Air Tempera- ture	0°C to 40°C (with no freezing)													
	Surrounding Air Humidity	20% to 80% relative humidity (with no condensation)													
	Installation Site	<ul style="list-style-type: none"> • Must be indoors and free of corrosive and explosive gases. • Must be well-ventilated and free of dust and moisture. • Must facilitate inspection and cleaning. • Must have an altitude of 1,000 m or less. • Must be free of strong magnetic fields. 													
Shock Resis- tance	Impact Accelera- tion Rate	196 m/s ²													
	Number of Impacts	2 times													
Vibra- tion Resis- tance	Vibration Accelera- tion Rate	49 m/s ² (the vibration resistance in three directions, vertical, side-to-side, and front-to-back)													

Ratings

Linear Servomotor Moving Coil Model SGLTW-		Standard Models										High-efficiency Models			
		20A			35A			40A		80A		35A		50A	
		170A	320A	460A	170A	320A	460A	400B	600B	400B	600B	170H	320H	170H	320H
Rated Motor Speed (Reference Speed during Speed Control)* ¹		3.0	3.0	3.0	2.5	2.5	2.5	1.5	2.0	2.0	2.0	2.5	2.0	2.0	2.0
Maximum Speed* ¹	m/s	5.0	5.0	5.0	5.0	5.0	5.0	3.1	3.1	2.5	2.5	4.8	4.8	3.2	3.1
Rated Force* ^{1,2}	N	130	250	380	220	440	670	670	1000	1300	2000	300	600	450	900
Maximum Force* ¹	N	380	760	1140	660	1320	2000	2600	4000	5000	7500	600	1200	900	1800
Rated Current* ¹	Arms	2.3	4.4	6.7	3.5	7.0	10.7	7.3	10.9	11.1	17.1	5.1	10.1	5.1	10.2
Maximum Current* ¹	Arms	7.7	15.4	23.2	12.1	24.2	36.7	39.4	60.6	57.9	86.9	11.9	23.9	11.8	23.6
Moving Coil Mass	kg	2.5	4.6	6.7	3.7	6.8	10	15	23	24	35	4.9	8.8	6.0	11
Force Constant	N/Arms	61.0	61.0	61.0	67.5	67.5	67.5	99.1	99.1	126	126	64.0	64.0	95.2	95.2
BEMF Constant	Vrms/ (m/s)/ phase	20.3	20.3	20.3	22.5	22.5	22.5	33.0	33.0	42.0	42.0	21.3	21.3	31.7	31.7
Motor Constant	N/√W	18.7	26.5	32.3	26.7	37.5	46.4	61.4	75.2	94.7	116	37.4	52.9	48.6	68.7
Electrical Time Constant	ms	5.9	5.9	5.9	6.9	6.8	6.9	15	15	17	17	15	16	16	17
Mechanical Time Constant	ms	7.1	6.6	6.4	5.2	4.8	4.6	4.0	4.1	2.7	2.6	3.5	3.1	2.5	2.4
Thermal Resistance (with Heat Sink)	K/W	1.01	0.49	0.38	0.76	0.44	0.32	0.24	0.20	0.22	0.18	0.76	0.40	0.61	0.30
Thermal Resistance (without Heat Sink)	K/W	1.82	1.11	0.74	1.26	0.95	0.61	0.57	0.40	0.47	0.33	1.26	0.83	0.97	0.80
Magnetic Attraction* ³	N	0	0	0	0	0	0	0	0	0	0	0	0	0	0
Magnetic Attraction on One Side* ⁴	N	800	1590	2380	1400	2780	4170	3950	5890	7650	11400	1400	2780	2000	3980
Maximum Allowable Payload	kg	25	50	76	44	88	130	280	440	690	1000	33	67	92	190
Maximum Allowable Payload (With External Regenerative Resistor and External Dynamic Brake Resistor)	kg	25	50	76	44	88	130	280	440	690	1000	40	82	95	190
Combined Magnetic Way, SGLTM-		20□□□□□			35□□□□□			40□□□□□		80□□□□□		35□□□□□		50□□□□□	
Combined Serial Converter Unit, JZDP-□□□□-		011	012	013	014	015	016	185	186	187	188	105	106	108	109
Applicable SERVOPACKs	SGD7S-	3R8A	7R6A	120A	5R5A	120A	180A		330A		550A	5R5A	120A	5R5A	120A
	SGD7W-SGD7C-	5R5A	7R6A	-	5R5A	-		-		-		5R5A	-	5R5A	-

*1. These values are for operation in combination with a SERVOPACK when the temperature of the armature winding is 100°C. The values for other items are at 20°C. These are typical values.

*2. The rated forces are the continuous allowable force values at a surrounding air temperature of 40°C with an aluminum heat sink of the dimensions given in the following table.

- Heat Sink Dimensions
 - 254 mm × 254 mm × 25 mm: SGLTW-20A170A and -35A170A
 - 400 mm × 500 mm × 40 mm: SGLTW-20A320A, -20A460A, -35A170H, -35A320A, -35A320H, -35A460A, and -50A170H
 - 609 mm × 762 mm × 50 mm: SGLTW-40A400B, -40A600B, -50A320H, -80A400B, and -80A600B

*3. The unbalanced magnetic gap that results from the Moving Coil installation condition causes a magnetic attraction on the Moving Coil.

*4. The value that is given is the magnetic attraction that is generated on one side of the Magnetic Way.

Force-Motor Speed Characteristics

▭ A : Continuous duty zone ——— (solid lines): With three-phase 200-V input
▭ B : Intermittent duty zone - - - - - (dotted lines): With single-phase 200-V input

Standard Models

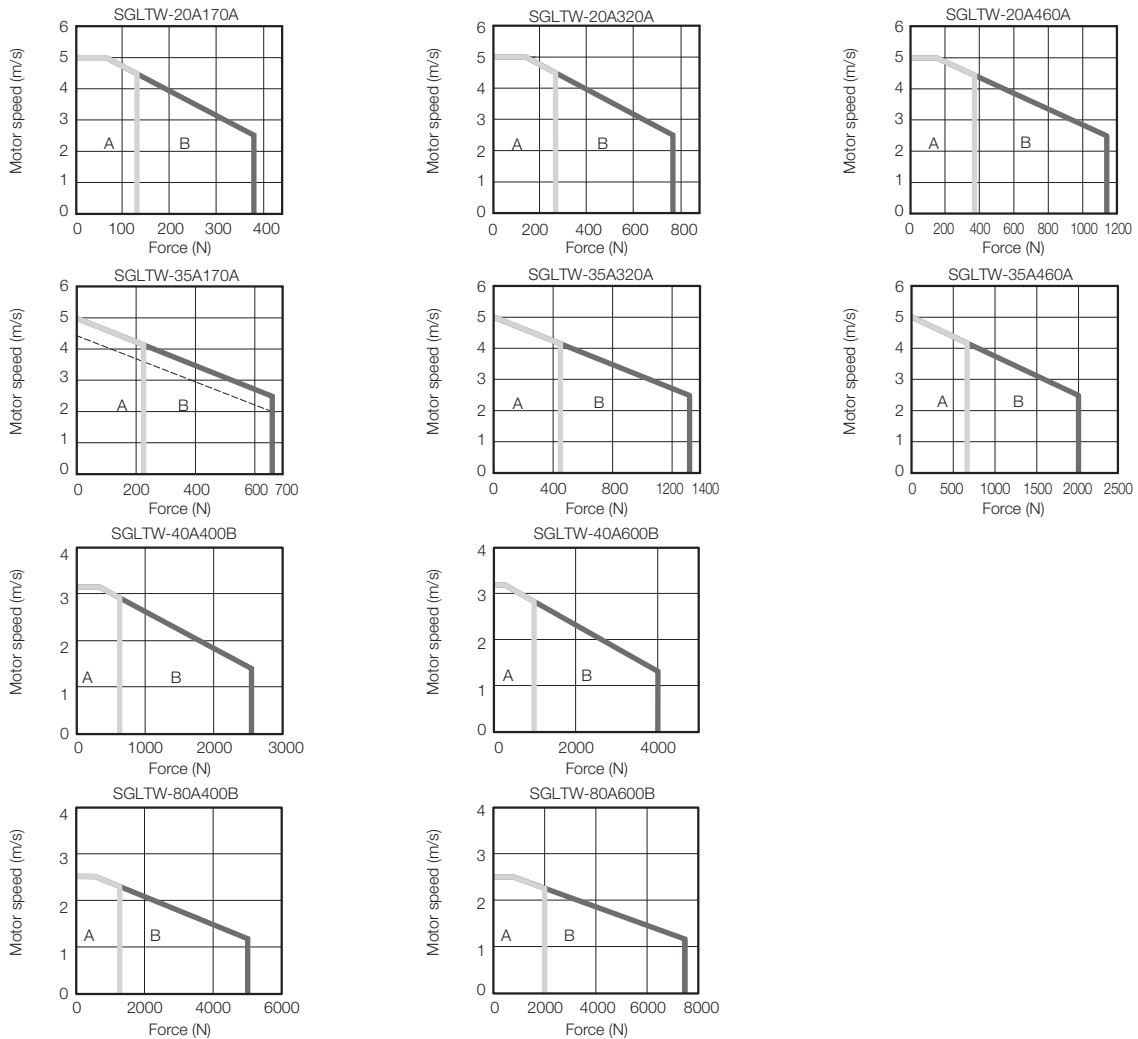

High-efficiency Models

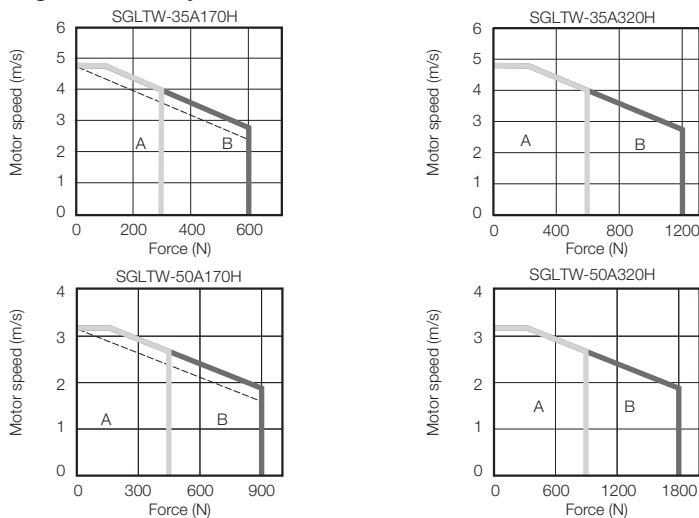

- Note: 1. These values (typical values) are for operation in combination with a SERVOPACK when the temperature of the armature winding is 100°C.
2. The characteristics in the intermittent duty zone depend on the power supply voltage.
3. If the effective force is within the allowable range for the rated force, the Servomotor can be used within the intermittent duty zone.
4. If you use a Servomotor Main Circuit Cable that exceeds 20 m, the intermittent duty zone in the torque-motor speed characteristics will become smaller because the voltage drop increases.

Servomotor Overload Protection Characteristics

The overload detection level is set for hot start conditions with a Servomotor surrounding air temperature of 40°C.

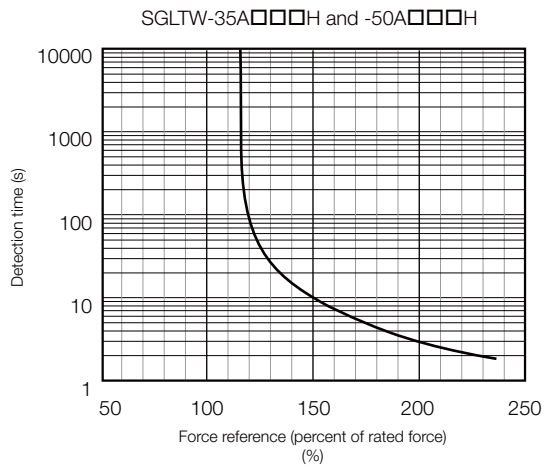
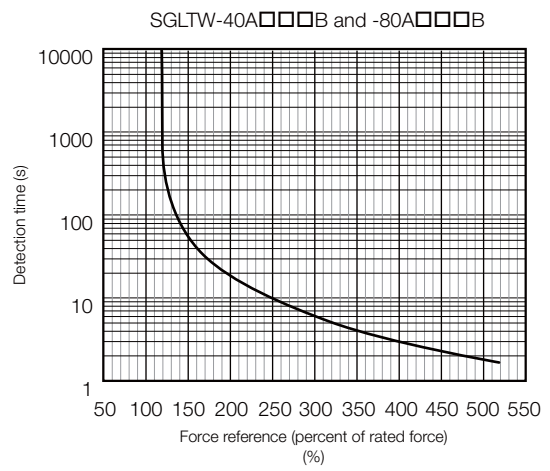
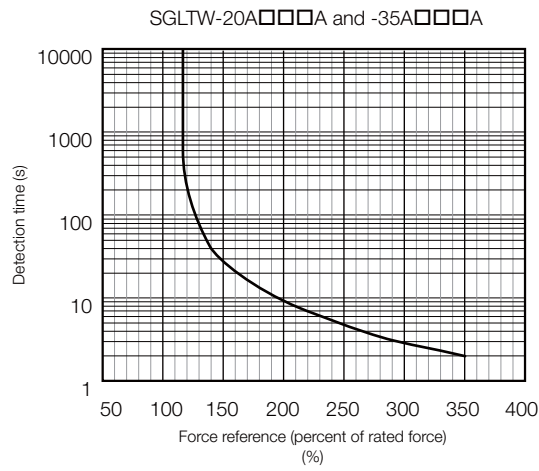

Note: The above overload protection characteristics do mean that you can perform continuous duty operation with an output of 100% or higher. Use the Servomotor so that the effective force remains within the continuous duty zone given in *Force-Motor Speed Characteristics* on page 286.

External Dimensions

SGLTW-20: Standard Models

◆ Moving Coils: SGLTW-20A□□□A□

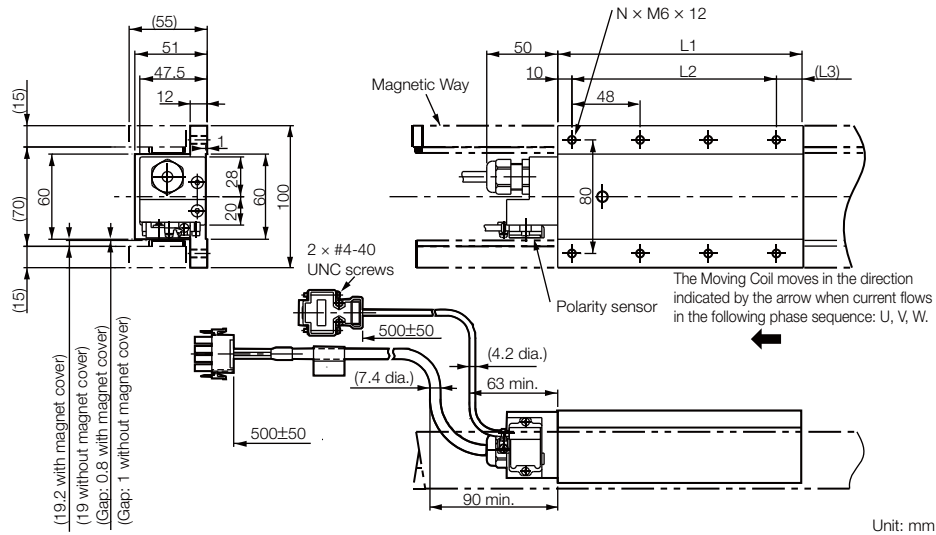

Moving Coil Model SGLTW-	L1	L2	(L3)	N	Approx. Mass [kg]
20A170A□	170	144 (48 × 3)	(16)	8	2.5
20A320A□	315	288 (48 × 6)	(17)	14	4.6
20A460A□	460	432 (48 × 9)	(18)	20	6.7

■ Connector Specifications

• Servomotor Connector

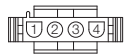

1	Phase U	Red
2	Phase V	White
3	Phase W	Blue
4	FG	Green

Plug: 350779-1
Pins: 350218-3 or 350547-3 (No.1 to 3)
350654-1 or 350669-1 (No. 4)
From Tyco Electronics Japan G.K.

Mating Connector

Cap: 350780-1
Socket: 350537-3 or 350550-3

• Polarity Sensor Connector

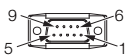

1	+5 V (DC)	6	Not used
2	Phase U	7	
3	Phase V	8	
4	Phase W	9	
5	0 V	-	-

Pin connector: 17JE-23090-02 (D8C)-CG
From DDK Ltd.

Mating Connector

Socket connector: 17JE-13090-02 (D8C)A-CG
Studs: 17L-002C or 17L-002C1

■ Polarity Sensor Output Signal

The figure on the right shows the relationship between the S_u , S_v , and S_w polarity sensor output signals and the inverse power of each motor phase V_u , V_v , and V_w when the Moving Coil moves in the direction indicated by the arrow in the dimensional drawings of the Moving Coil.

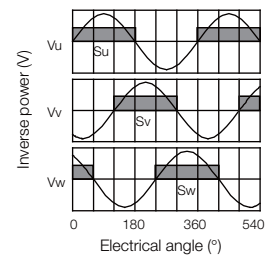

◆ Magnetic Ways: SGLTM-20□□□A

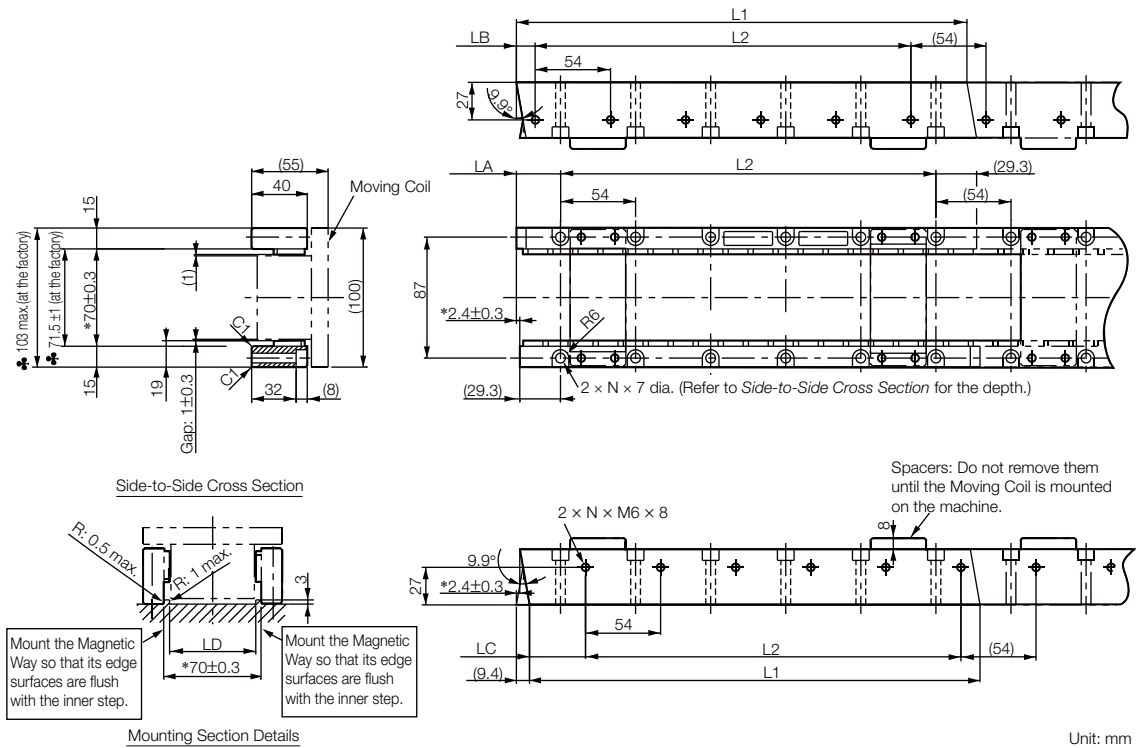

- Note: 1. Two Magnetic Way tracks are used together as a set. For safety, when they are shipped, the two tracks are secured to a mounting spacer made from aluminum.
2. More than one Magnetic Way can be connected.
3. Dimensions with asterisks are the distances between the Magnetic Way tracks. Install the tracks according to the specified dimensions. Observe the dimensions given in *Mounting Section Details* after installation. Dimensions when the Magnetic Way is shipped from the factory are indicated by ♣.
4. Use socket head screws of strength class 10.9 or higher for the Magnetic Way mounting screws. (Do not use stainless steel screws.)

Magnetic Way Model SGLTM-	L1	L2	LA	LB	LC	LD	N	Approx. Mass [kg]
20324A□	324 ^{-0.1} _{-0.3}	270 (54 × 5)	31.7 ⁰ _{-0.2}	13.7 ⁰ _{-0.2}	40.3 ⁰ _{-0.2}	62 ^{+0.6} ₀	6	3.4
20540A□	540 ^{-0.1} _{-0.3}	486 (54 × 9)	31.7 ⁰ _{-0.2}	13.7 ⁰ _{-0.2}	40.3 ⁰ _{-0.2}	62 ^{+0.6} ₀	10	5.7
20756A□	756 ^{-0.1} _{-0.3}	702 (54 × 13)	31.7 ⁰ _{-0.2}	13.7 ⁰ _{-0.2}	40.3 ⁰ _{-0.2}	62 ^{+0.6} ₀	14	7.9

◆ Magnetic Ways with Bases: SGLTM-20□□□AY

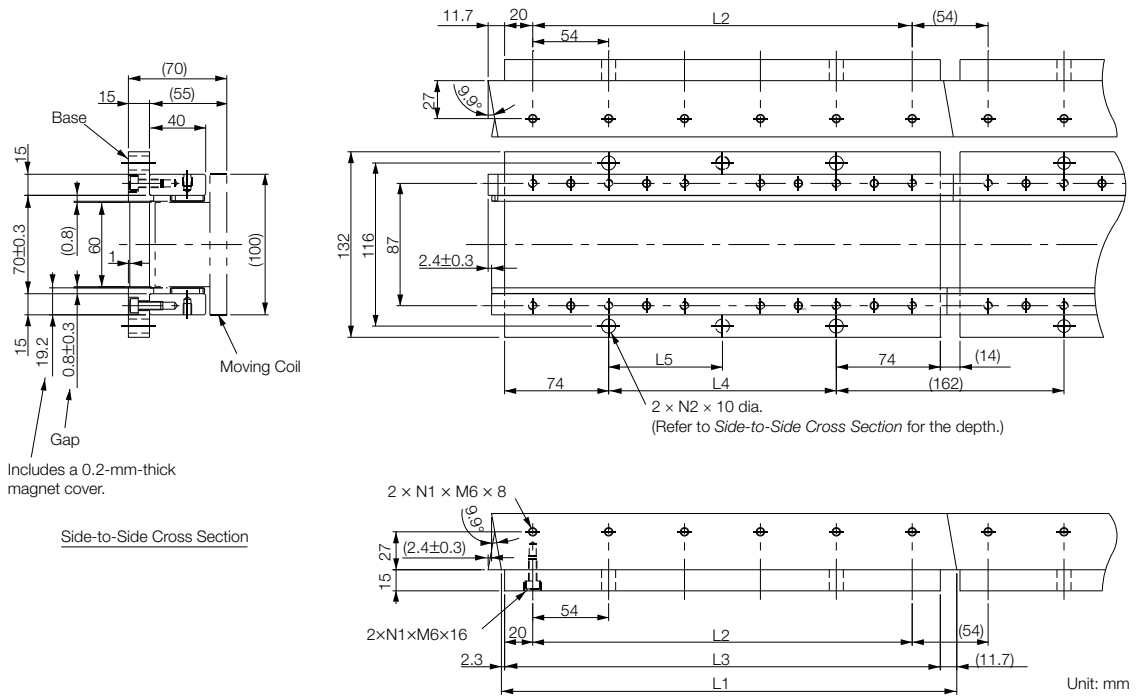

Note: Two Magnetic Way tracks are used together as a set. More than one Magnetic Way can be connected.

Magnetic Way Model SGLTM-	L1	L2	L3	L4	L5	N1	N2	Approx. Mass [kg]
20324AY	324 ^{-0.1} _{-0.3}	270	310	162	162	6	2	5.1
20540AY	540 ^{-0.1} _{-0.3}	486	526	378	189	10	3	8.5
20756AY	756 ^{-0.1} _{-0.3}	702	742	594	198	14	4	12

SGLTW-35: Standard Models

◆ Moving Coils: SGLTW-35A□□□□A□

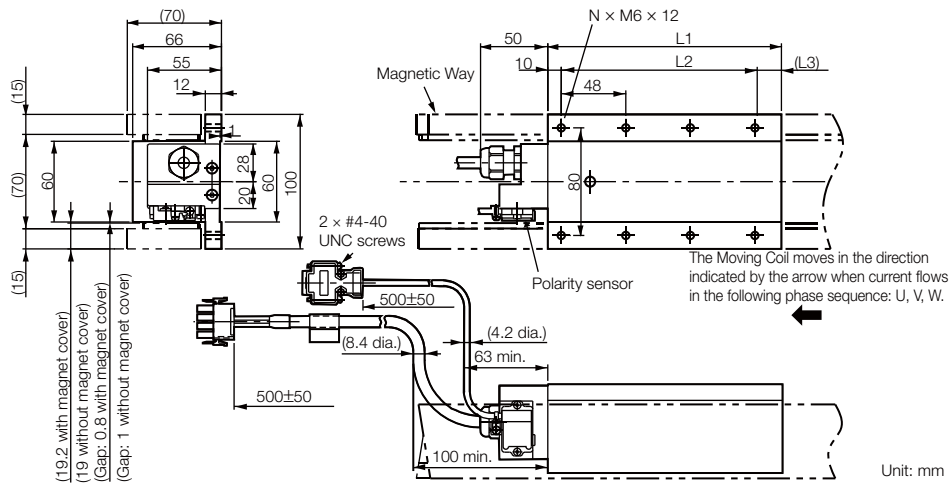

Moving Coil Model SGLTW-	L1	L2	(L3)	N	Approx. Mass [kg]
35A170A□	170	144 (48 × 3)	(16)	8	3.7
35A320A□	315	288 (48 × 6)	(17)	14	6.8
35A460A□	460	432 (48 × 9)	(18)	20	10

■ Connector Specifications

• Servomotor Connector

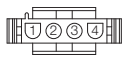

1	Phase U	Red
2	Phase V	White
3	Phase W	Blue
4	FG	Green

Plug: 350779-1
Pins: 350218-3 or 350547-3 (No. 1 to 3)
350654-1 or 350669-1 (No. 4)
From Tyco Electronics Japan G.K.
Mating Connector
Cap: 350780-1
Socket: 350537-3 or 350550-3

• Polarity Sensor Connector

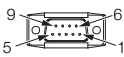

1	+5 V (DC)	6	Not used
2	Phase U	7	
3	Phase V	8	
4	Phase W	9	
5	0 V	-	-

Pin connector: 17JE-23090-02 (D8C)-CG
From DDK Ltd.
Mating Connector
Socket connector: 17JE-13090-02 (D8C)A-CG
Studs: 17L-002C or 17L-002C1

■ Polarity Sensor Output Signal

The figure on the right shows the relationship between the S_u , S_v , and S_w polarity sensor output signals and the inverse power of each motor phase V_u , V_v , and V_w when the Moving Coil moves in the direction indicated by the arrow in the dimensional drawings of the Moving Coil.

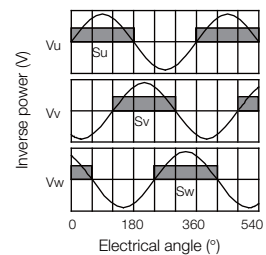

◆ Magnetic Ways: SGLTM-35□□□□□

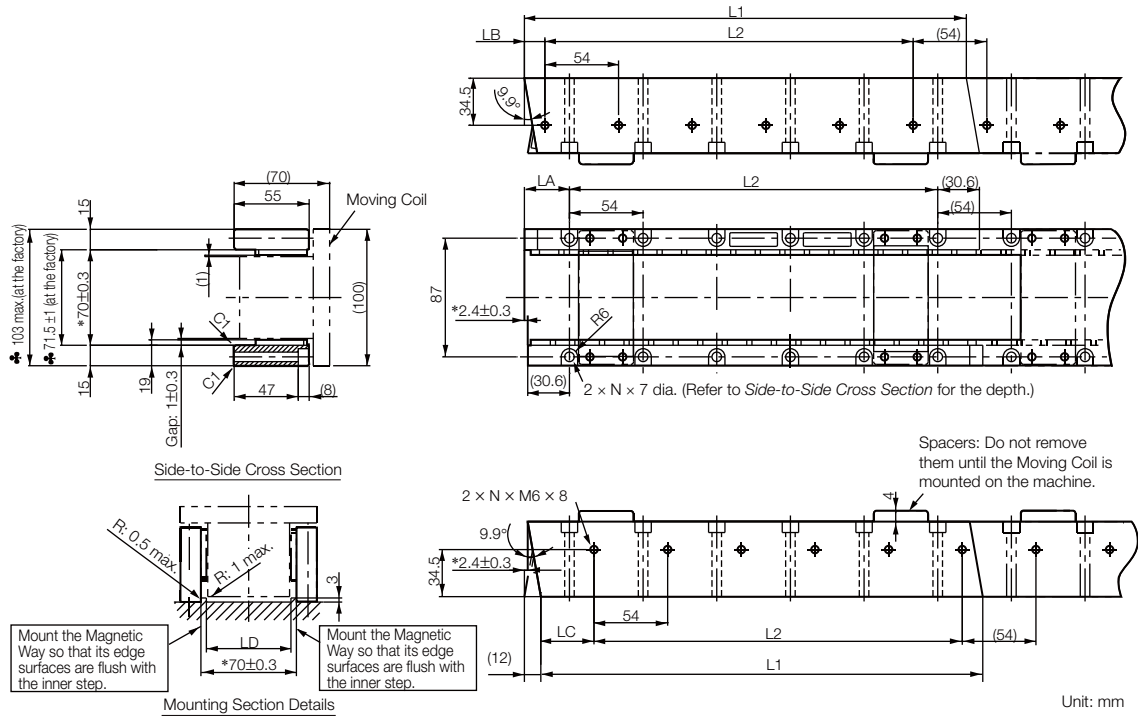

- Note: 1. Two Magnetic Way tracks are used together as a set. For safety, when they are shipped, the two tracks are secured to a mounting spacer made from aluminum.
2. More than one Magnetic Way can be connected.
3. Dimensions with asterisks are the distances between the Magnetic Way tracks. Install the tracks according to the specified dimensions. Observe the dimensions given in *Mounting Section Details* after installation. Dimensions when the Magnetic Way is shipped from the factory are indicated by ♣.
4. Use socket head screws of strength class 10.9 or higher for the Magnetic Way mounting screws. (Do not use stainless steel screws.)

Magnetic Way Model SGLTM-	L1	L2	LA	LB	LC	LD	N	Approx. Mass [kg]
35324A□	324 ^{-0.1} _{-0.3}	270 (54 × 5)	33 ⁰ _{-0.2}	15 ⁰ _{-0.2}	39 ⁰ _{-0.2}	62 ^{+0.6} ₀	6	4.8
35540A□	540 ^{-0.1} _{-0.3}	486 (54 × 9)	33 ⁰ _{-0.2}	15 ⁰ _{-0.2}	39 ⁰ _{-0.2}	62 ^{+0.6} ₀	10	8
35756A□	756 ^{-0.1} _{-0.3}	702 (54 × 13)	33 ⁰ _{-0.2}	15 ⁰ _{-0.2}	39 ⁰ _{-0.2}	62 ^{+0.6} ₀	14	11

◆ Magnetic Ways with Bases: SGLTM-35□□□AY

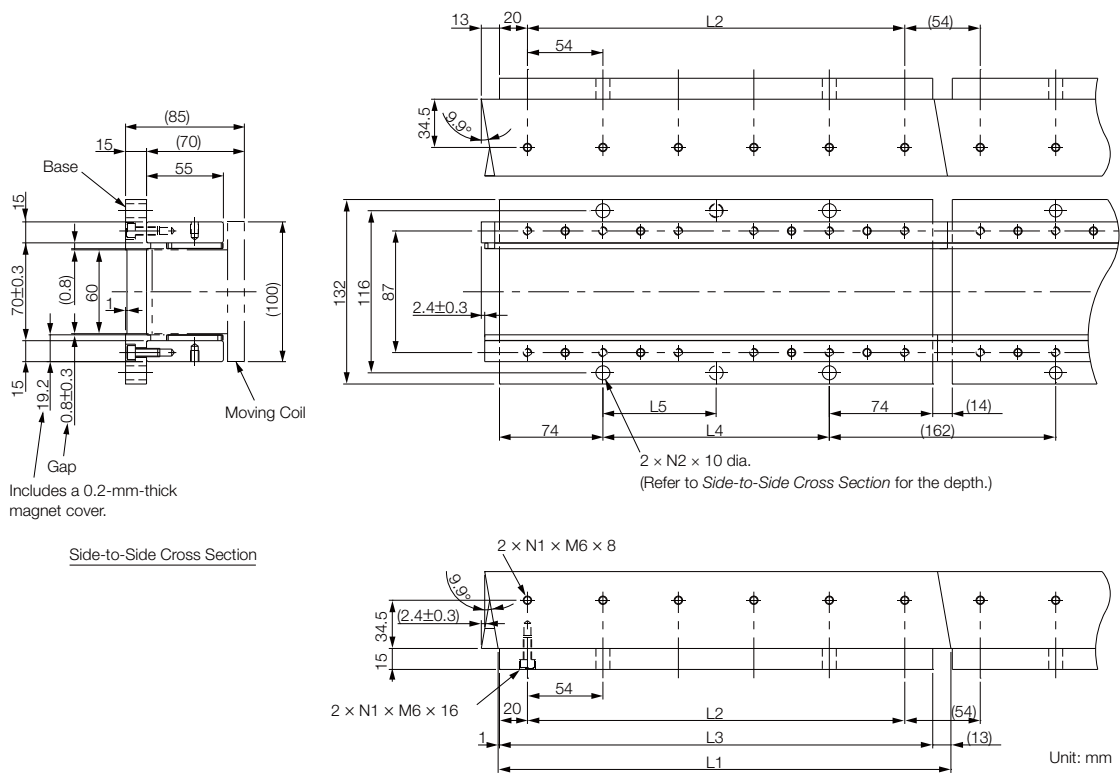

Note: Two Magnetic Way tracks are used together as a set. More than one Magnetic Way can be connected.

Magnetic Way Model SGLTM-	L1	L2	L3	L4	L5	N1	N2	Approx. Mass [kg]
35324AY	324 ^{-0.1} _{-0.3}	270	310	162	162	6	2	6.4
35540AY	540 ^{-0.1} _{-0.3}	486	526	378	189	10	3	11
35756AY	756 ^{-0.1} _{-0.3}	702	742	594	198	14	4	15

SGLTW-35□□□□H□: High-Efficiency Models

◆ Moving Coils: SGLTW-35A□□□□H□

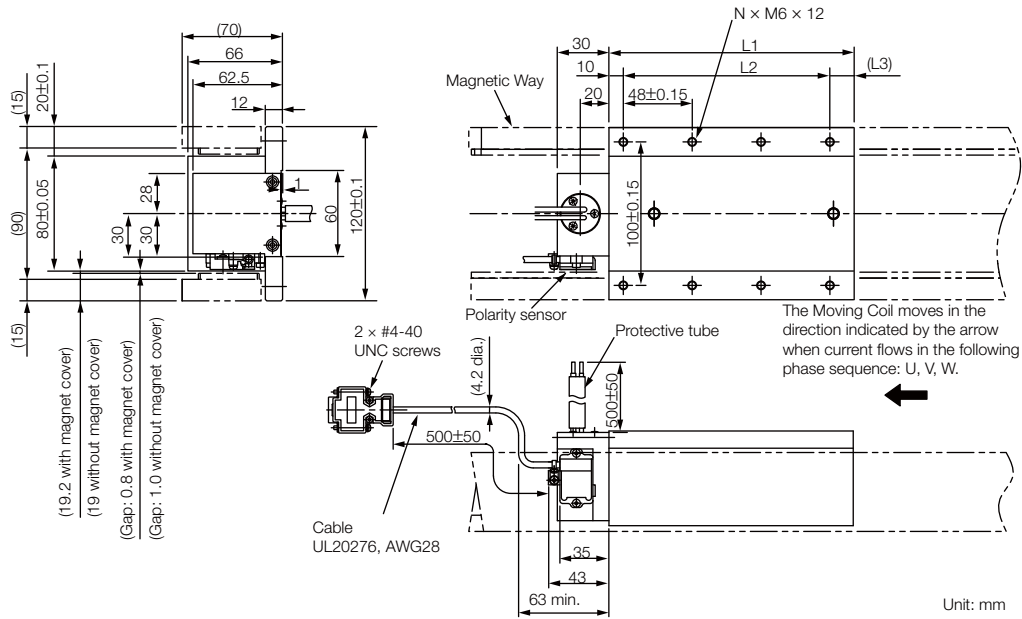

Moving Coil Model SGLTW-	L1	L2	L3	N	Approx. Mass [kg]
35A170H□	170	144 (48 × 3)	(16)	8	4.7
35A320H□	315	288 (48 × 6)	(17)	14	8.8

■ Connector Specifications

• Moving Coil Lead

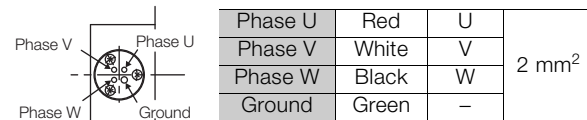

(Viewed from the top surface of the Moving Coil.)

Secure the lead from the Moving Coil of the Linear Servomotor so that it moves together with the Moving Coil.

• Polarity Sensor Connector

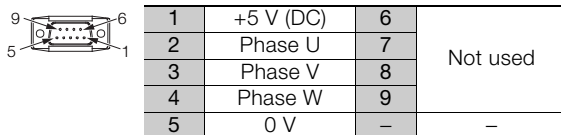

Pin connector: 17JE-23090-02 (D8C)-CG
From DDK Ltd.

Mating Connector

Socket connector: 17JE-13090-02 (D8C)A-CG
Studs: 17L-002C or 17L-002C1

■ Polarity Sensor Output Signal

The figure on the right shows the relationship between the S_u , S_v , and S_w polarity sensor output signals and the inverse power of each motor phase V_u , V_v , and V_w when the Moving Coil moves in the direction indicated by the arrow in the dimensional drawings of the Moving Coil.

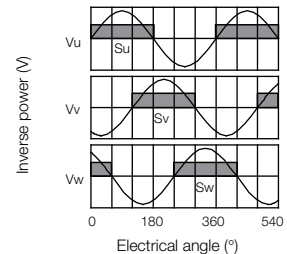

◆ Magnetic Ways: SGLTM-35□□□H□

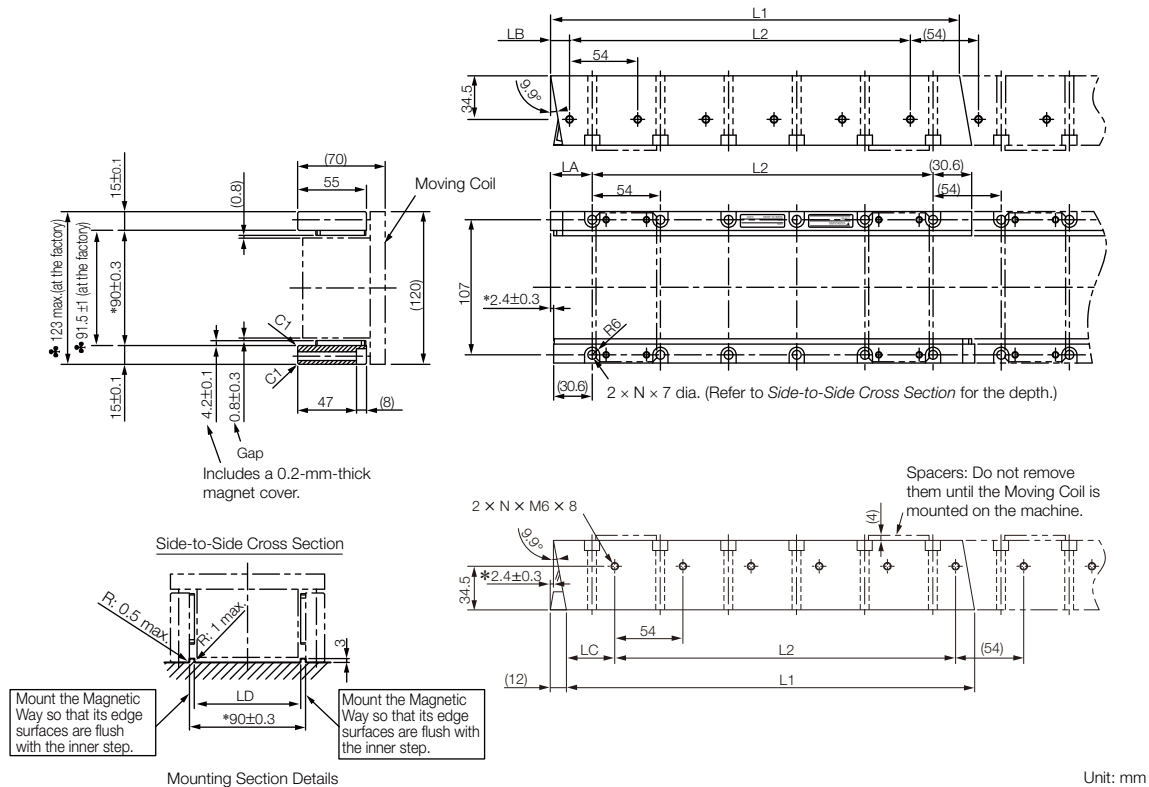

- Note: 1. Two Magnetic Way tracks are used together as a set. For safety, when they are shipped, the two tracks are secured to a mounting spacer made from aluminum.
2. More than one Magnetic Way can be connected.
3. Dimensions with asterisks are the distances between the Magnetic Way tracks. Install the tracks according to the specified dimensions. Observe the dimensions given in *Mounting Section Details* after installation. Dimensions when the Magnetic Way is shipped from the factory are indicated by ♣.
4. Use socket head screws of strength class 10.9 or higher for the Magnetic Way mounting screws. (Do not use stainless steel screws.)

Magnetic Way Model SGLTM-	L1	L2	LA	LB	LC	LD	N	Approx. Mass [kg]
35324H□	324 ^{-0.1} _{-0.3}	270 (54 × 5)	33 ⁰ _{-0.2}	15 ⁰ _{-0.2}	39 ⁰ _{-0.2}	82 ^{+0.6} ₀	6	4.8
35540H□	540 ^{-0.1} _{-0.3}	486 (54 × 9)	33 ⁰ _{-0.2}	15 ⁰ _{-0.2}	39 ⁰ _{-0.2}	82 ^{+0.6} ₀	10	8
35756H□	756 ^{-0.1} _{-0.3}	702 (54 × 13)	33 ⁰ _{-0.2}	15 ⁰ _{-0.2}	39 ⁰ _{-0.2}	82 ^{+0.6} ₀	14	11

SGLTW-40: Standard Models

◆ Moving Coils: SGLTW-40A□□□B□

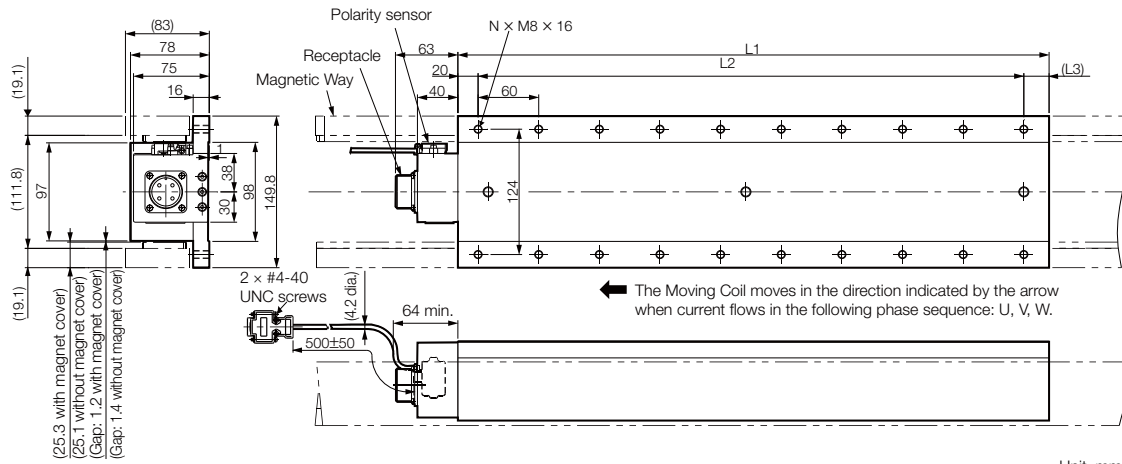

Unit: mm

Moving Coil Model SGLTW-	L1	L2	(L3)	N	Approx. Mass [kg]
40A400B□	394.2	360 (60 × 6)	(15)	14	15
40A600B□	574.2	540 (60 × 9)	(15)	20	22

■ Connector Specifications

• Servomotor Connector



A	Phase U
B	Phase V
C	Phase W
D	Ground

Receptacle: MS3102A-22-22P
From DDK Ltd.

Mating Connector

Right-angle plug: MS3108B22-22S
Straight plug: MS3106B22-22S
Cable clamp: MS3057-12A

• Polarity Sensor Connector

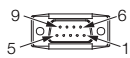

1	+5 V (power supply)	6	Not used
2	Phase U	7	
3	Phase V	8	
4	Phase W	9	
5	0 V (power supply)	—	

Pin connector: 17JE-23090-02 (D8C)-CG
From DDK Ltd.

Mating Connector

Socket connector: 17JE-13090-02 (D8C)A-CG
Studs: 17L-002C or 17L-002C1

■ Polarity Sensor Output Signal

The figure on the right shows the relationship between the S_u , S_v , and S_w polarity sensor output signals and the inverse power of each motor phase V_u , V_v , and V_w when the Moving Coil moves in the direction indicated by the arrow in the dimensional drawings of the Moving Coil.

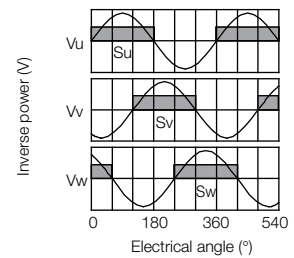

◆ Magnetic Ways: SGLTM-40□□□A□

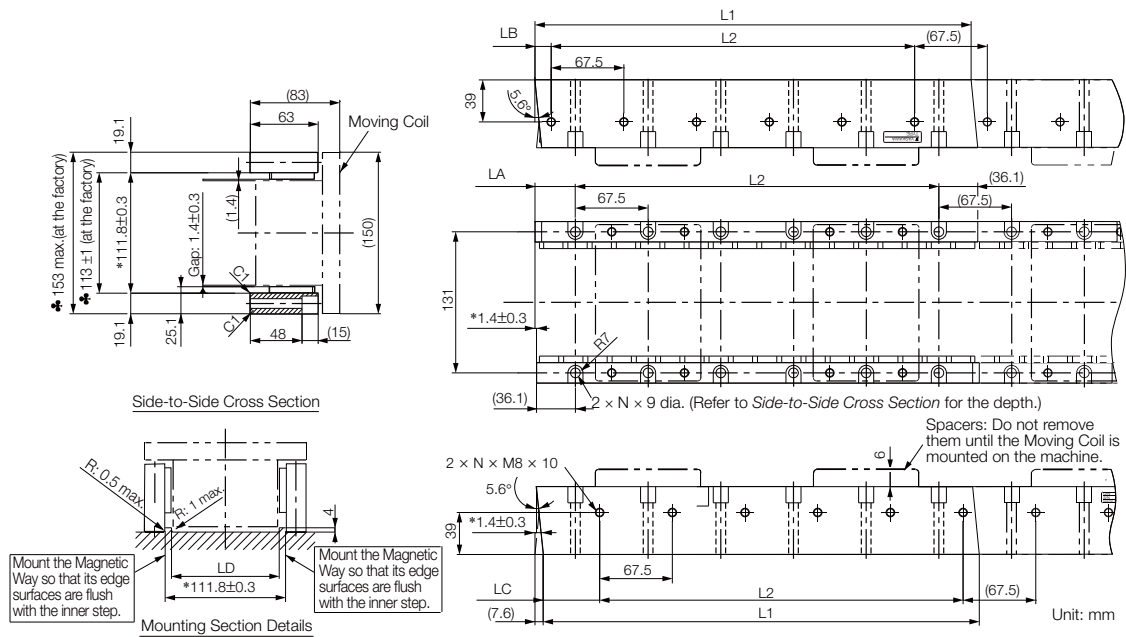

- Note: 1. Two Magnetic Way tracks are used together as a set. For safety, when they are shipped, the two tracks are secured to a mounting spacer made from aluminum.
2. More than one Magnetic Way can be connected.
3. Dimensions with asterisks are the distances between the Magnetic Way tracks. Install the tracks according to the specified dimensions. Observe the dimensions given in *Mounting Section Details* after installation. Dimensions when the Magnetic Way is shipped from the factory are indicated by ♣.
4. Use socket head screws of strength class 10.9 or higher for the Magnetic Way mounting screws. (Do not use stainless steel screws.)

Magnetic Way Model SGLTM-	L1	L2	LA	LB	LC	LD	N	Approx. Mass [kg]
40405A□	405 ^{-0.1} _{-0.3}	337.5 (67.5 × 5)	37.5 ⁰ _{-0.2}	15 ⁰ _{-0.2}	52.5 ⁰ _{-0.2}	100 ^{+0.6} ₀	6	9
40675A□	675 ^{-0.1} _{-0.3}	607.5 (67.5 × 9)	37.5 ⁰ _{-0.2}	15 ⁰ _{-0.2}	52.5 ⁰ _{-0.2}	100 ^{+0.6} ₀	10	15
40945A□	945 ^{-0.1} _{-0.3}	877.5 (67.5 × 13)	37.5 ⁰ _{-0.2}	15 ⁰ _{-0.2}	52.5 ⁰ _{-0.2}	100 ^{+0.6} ₀	14	21

◆ Magnetic Ways with Bases: SGLTM-40□□□AY

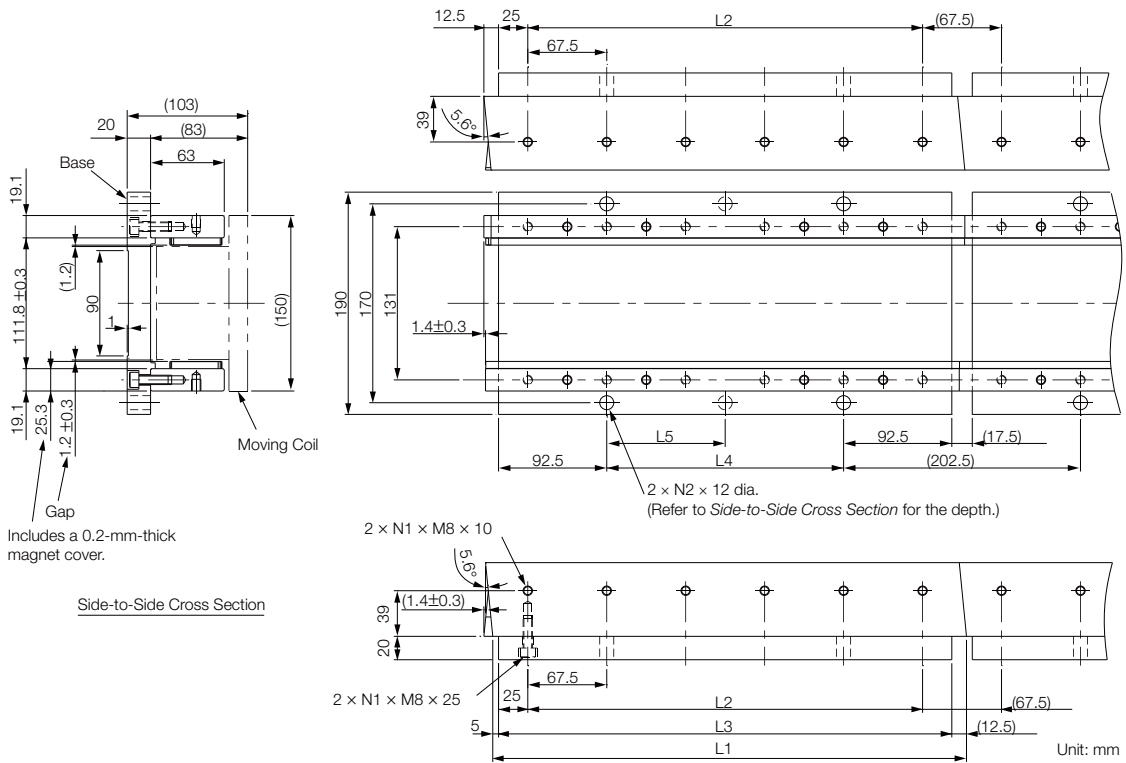

Note: Two Magnetic Way tracks are used together as a set. More than one Magnetic Way can be connected.

Magnetic Way Model SGLTM-	L1	L2	L3	L4	L5	N1	N2	Approx. Mass [kg]
40405AY	405 ^{-0.1 -0.3}	337.5	387.5	202.5	202.5	6	2	13
40675AY	675 ^{-0.1 -0.3}	607.5	657.5	472.5	236.25	10	3	21
40945AY	945 ^{-0.1 -0.3}	877.5	927.5	742.5	247.5	14	4	30

SGLTW-50: High-Efficiency Models

◆ Moving Coils: SGLTW-50A□□□H□

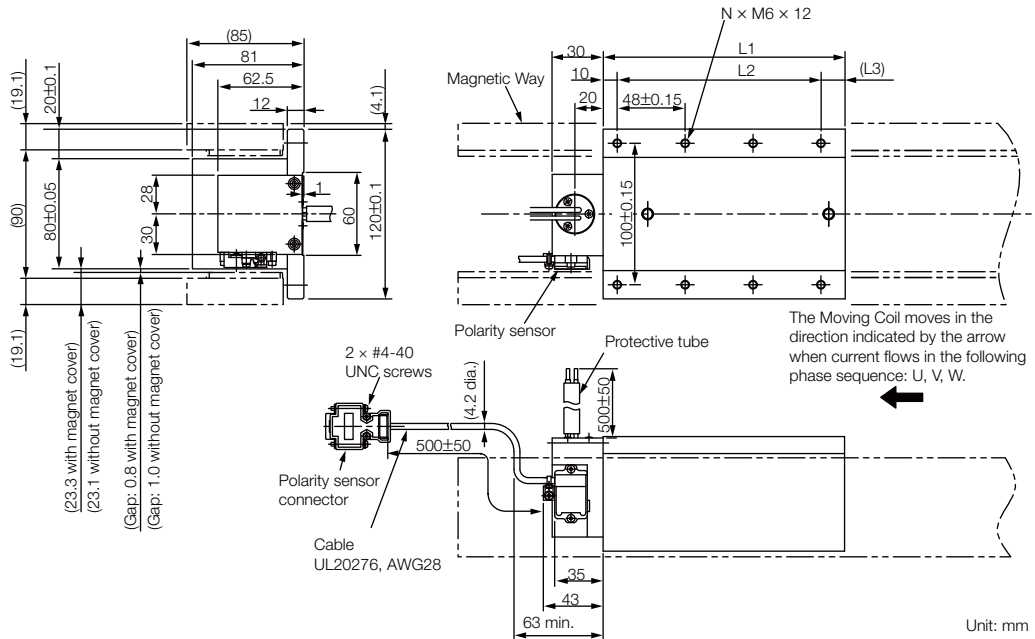

Moving Coil Model SGLTW-	L1	L2	(L3)	N	Approx. Mass [kg]
50A170H□	170	144 (48 × 3)	(16)	8	6
50A320H□	315	288 (48 × 6)	(17)	14	11

■ Connector Specifications

• Moving Coil Lead

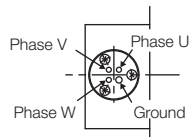

(Viewed from the top surface of the Moving Coil.)

Phase U	Red	U	2 mm ²
Phase V	White	V	
Phase W	Black	W	
Ground	Green	-	

Secure the lead from the Moving Coil of the Linear Servomotor so that it moves together with the Moving Coil.

• Polarity Sensor Connector

1	+5 V (DC)	6	Not used
2	Phase U	7	
3	Phase V	8	
4	Phase W	9	
5	0 V	-	

Pin connector: 17JE-23090-02 (D8C)-CG
From DDK Ltd.

Mating Connector

Socket connector: 17JE-13090-02 (D8C)A-CG
Studs: 17L-002C or 17L-002C1

■ Polarity Sensor Output Signal

The figure on the right shows the relationship between the S_u , S_v , and S_w polarity sensor output signals and the inverse power of each motor phase V_u , V_v , and V_w when the Moving Coil moves in the direction indicated by the arrow in the dimensional drawings of the Moving Coil.

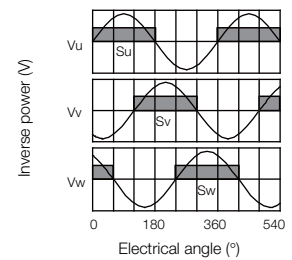

◆ Magnetic Ways: SGLTM-50□□□□□

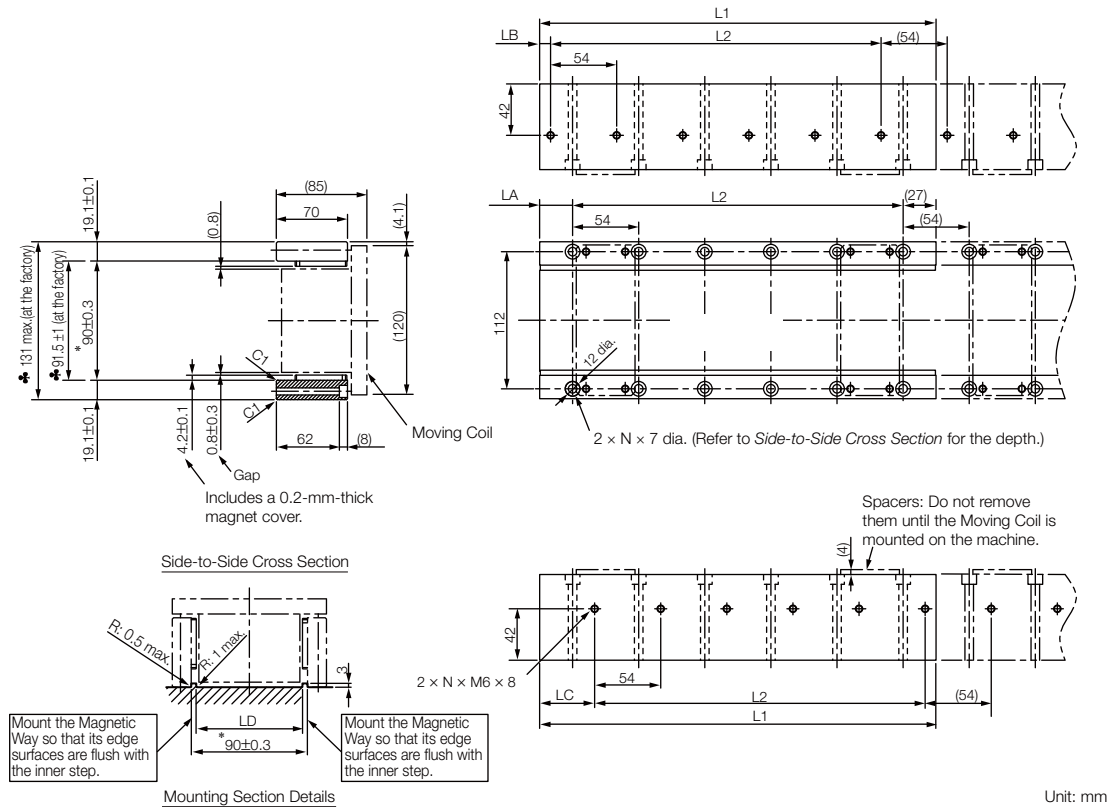

- Note: 1. Two Magnetic Way tracks are used together as a set. For safety, when they are shipped, the two tracks are secured to a mounting spacer made from aluminum.
2. More than one Magnetic Way can be connected.
3. Dimensions with asterisks are the distances between the Magnetic Way tracks. Install the tracks according to the specified dimensions. Observe the dimensions given in *Mounting Section Details* after installation. Dimensions when the Magnetic Way is shipped from the factory are indicated by ♣.
4. Use socket head screws of strength class 10.9 or higher for the Magnetic Way mounting screws. (Do not use stainless steel screws.)

Magnetic Way Model SGLTM-	L1	L2	LA	LB	LC	LD	N	Approx. Mass [kg]
50324H□	324 ^{-0.1} _{-0.3}	270 (54 × 5)	27 ⁰ _{-0.2}	9 ⁰ _{-0.2}	45 ⁰ _{-0.2}	82 ^{+0.6} ₀	6	8
50540H□	540 ^{-0.1} _{-0.3}	486 (54 × 9)	27 ⁰ _{-0.2}	9 ⁰ _{-0.2}	45 ⁰ _{-0.2}	82 ^{+0.6} ₀	10	13
50756H□	756 ^{-0.1} _{-0.3}	702 (54 × 13)	27 ⁰ _{-0.2}	9 ⁰ _{-0.2}	45 ⁰ _{-0.2}	82 ^{+0.6} ₀	14	18

SGLTW-80: Standard Models

◆ Moving Coils: SGLTW-80A□□□□

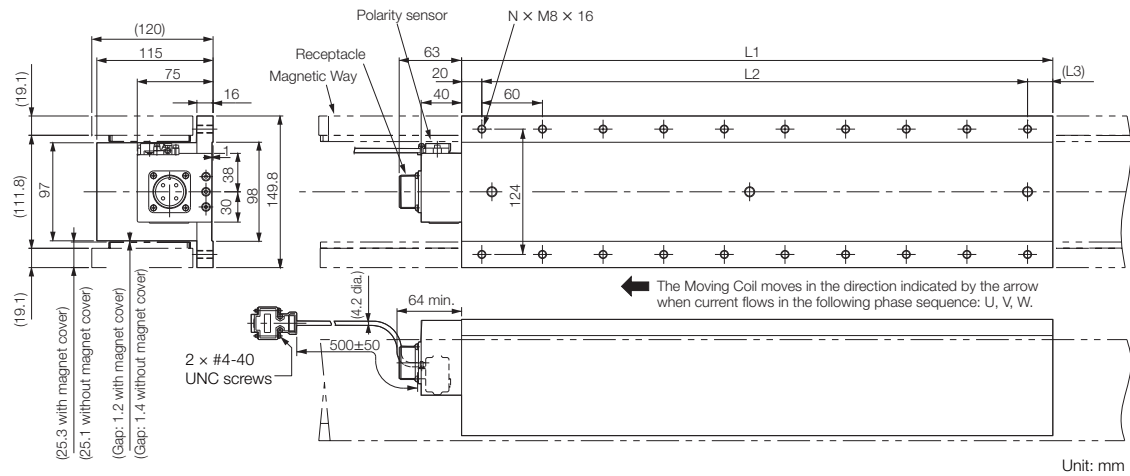

Moving Coil Model SGLTW-	L1	L2	(L3)	N	Approx. Mass [kg]
80A400B□	394.2	360 (60 × 6)	(15)	14	24
80A600B□	574.2	540 (60 × 9)	(15)	20	35

■ Connector Specifications

• Servomotor Connector



A	Phase U
B	Phase V
C	Phase W
D	Ground

Receptacle: MS3102A-22-22P
From DDK Ltd.

Mating Connector

Right-angle plug: MS3108B22-22S
Straight plug: MS3106B22-22S
Cable clamp: MS3057-12A

• Polarity Sensor Connector

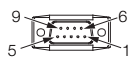

1	+5 V (power supply)	6	Not used
2	Phase U	7	
3	Phase V	8	
4	Phase W	9	
5	0 V (power supply)	-	-

Pin connector: 17JE-23090-02 (D8C)-CG
From DDK Ltd.

Mating Connector

Socket connector: 17JE-13090-02 (D8C)A-CG
Studs: 17L-002C or 17L-002C1

■ Polarity Sensor Output Signal

The figure on the right shows the relationship between the S_u , S_v , and S_w polarity sensor output signals and the inverse power of each motor phase V_u , V_v , and V_w when the Moving Coil moves in the direction indicated by the arrow in the dimensional drawings of the Moving Coil.

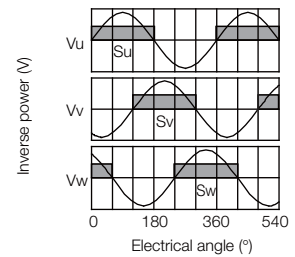

◆ Magnetic Ways: SGLTM-80□□□A□

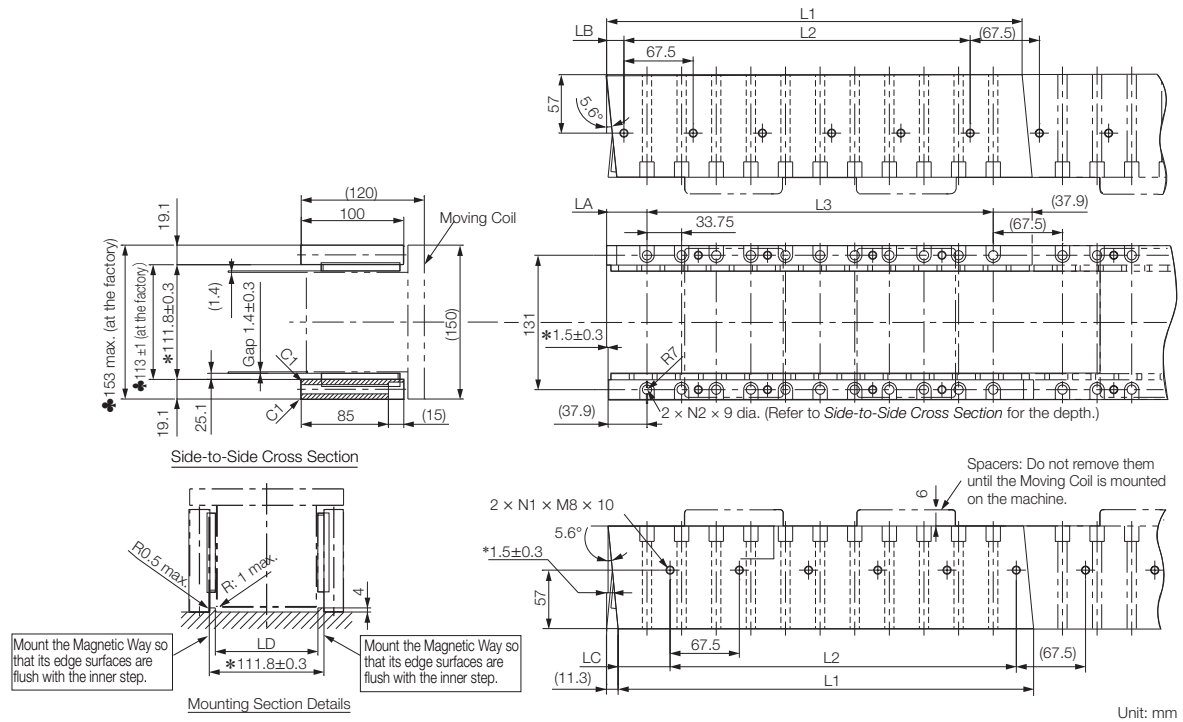

- Note: 1. Two Magnetic Way tracks are used together as a set. For safety, when they are shipped, the two tracks are secured to a mounting spacer made from aluminum.
2. More than one Magnetic Way can be connected.
3. Dimensions with asterisks are the distances between the Magnetic Way tracks. Install the tracks according to the specified dimensions. Observe the dimensions given in *Mounting Section Details* after installation. Dimensions when the Magnetic Way is shipped from the factory are indicated by ♣.
4. Use socket head screws of strength class 10.9 or higher for the Magnetic Way mounting screws. (Do not use stainless steel screws.)

Magnetic Way Model SGLTM-	L1	L2	L3	LA	LB	LC	LD	N1	N2	Approx. Mass [kg]
80405A□	405 ^{-0.1} _{-0.3}	337.5 (67.5 × 5)	337.5 (33.75 × 10)	39.4 ⁰ _{-0.2}	16.9 ⁰ _{-0.2}	50.6 ⁰ _{-0.2}	100 ^{+0.6} ₀	6	11	14
80675A□	675 ^{-0.1} _{-0.3}	607.5 (67.5 × 9)	607.5 (33.75 × 18)	39.4 ⁰ _{-0.2}	16.9 ⁰ _{-0.2}	50.6 ⁰ _{-0.2}	100 ^{+0.6} ₀	10	19	24
80945A□	945 ^{-0.1} _{-0.3}	877.5 (67.5 × 13)	887.5 (33.75 × 26)	39.4 ⁰ _{-0.2}	16.9 ⁰ _{-0.2}	50.6 ⁰ _{-0.2}	100 ^{+0.6} ₀	14	27	34

◆ Magnetic Ways with Bases: SGLTM-80□□□AY

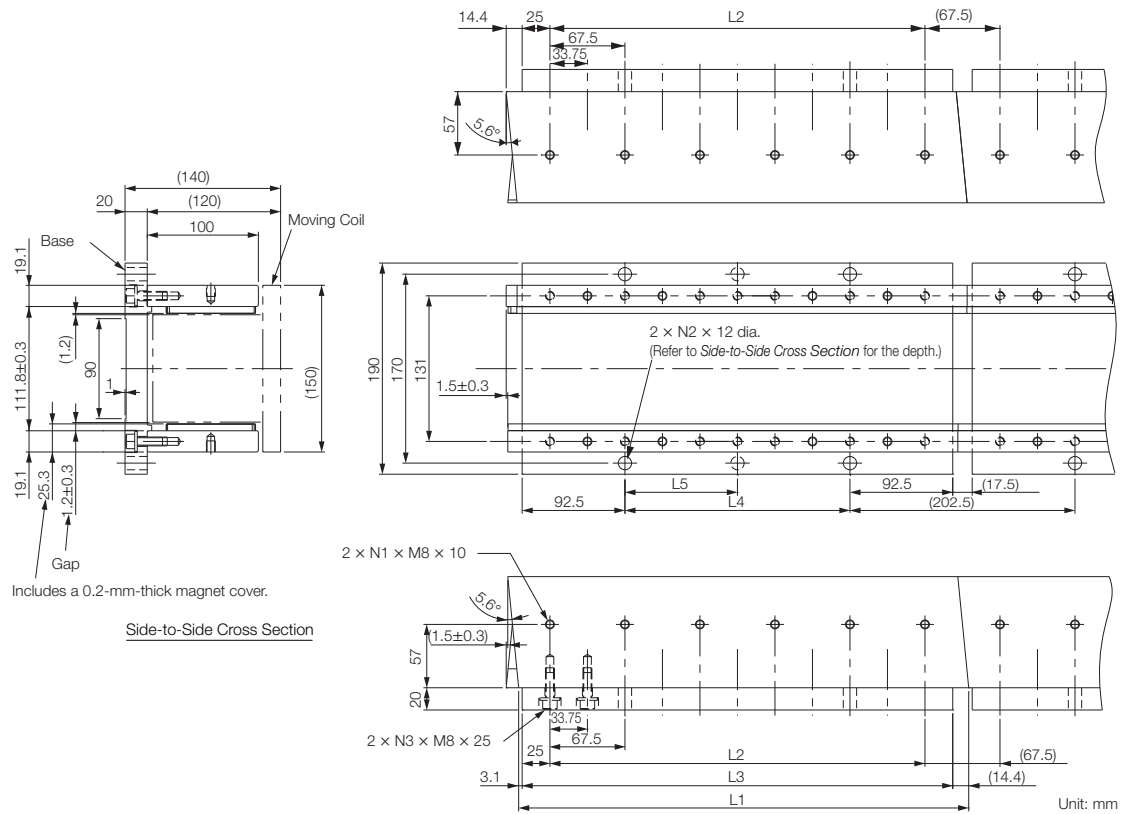

Note: Two Magnetic Way tracks are used together as a set. More than one Magnetic Way can be connected.

Magnetic Way Model SGLTM-	L1	L2	L3	L4	L5	N1	N2	N3	Approx. Mass [kg]
80405AY	405 ^{-0.1} _{-0.3}	337.5	387.5	202.5	202.5	6	2	11	18
80675AY	675 ^{-0.1} _{-0.3}	607.5	657.5	472.5	236.25	10	3	19	31
80945AY	945 ^{-0.1} _{-0.3}	877.5	927.5	742.5	247.5	14	4	27	43

Selecting Cables

◆ Cable Configurations

To select a Linear Encoder, use *Recommended Linear Encoders* (pages 308 and 309). Prepare the cable required for the encoder.

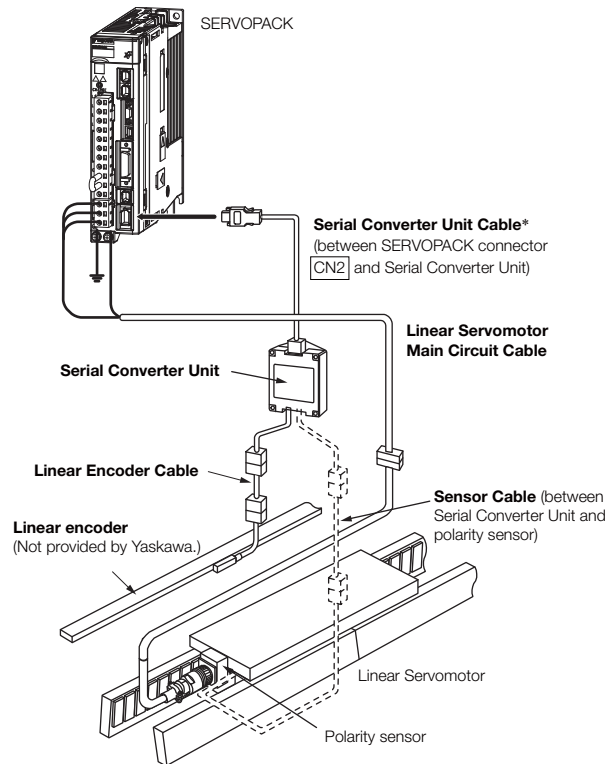

* You can connect directly to an absolute linear encoder.

Note: Refer to the following manual for the following information.

- Cable dimensional drawings and cable connection specifications
- Order numbers and specifications of individual connectors for cables
- Order numbers and specifications for wiring materials

📖 *Σ-7-Series AC Servo Drive Peripheral Device Selection Manual* (Manual No.: SIEP S800001 32)

◆ Linear Servomotor Main Circuit Cables

Linear Servomotor Model	Length (L)	Order Number	Appearance
SGLTW-20A, -35A	1 m	JZSP-CLN21-01-E	
	3 m	JZSP-CLN21-03-E	
	5 m	JZSP-CLN21-05-E	
	10 m	JZSP-CLN21-10-E	
	15 m	JZSP-CLN21-15-E	
	20 m	JZSP-CLN21-20-E	
SGLTW-□□A□□□□□□□□	1 m	JZSP-CLN14-01-E	
	3 m	JZSP-CLN14-03-E	
	5 m	JZSP-CLN14-05-E	
	10 m	JZSP-CLN14-10-E	
	15 m	JZSP-CLN14-15-E	
	20 m	JZSP-CLN14-20-E	
SGLTW-40□□□□□□□□ -80□□□□□□□□	1 m	JZSP-CLN39-01-E	
	3 m	JZSP-CLN39-03-E	
	5 m	JZSP-CLN39-05-E	
	10 m	JZSP-CLN39-10-E	
	15 m	JZSP-CLN39-15-E	
	20 m	JZSP-CLN39-20-E	

- *1. Connector from Tyco Electronics Japan G.K.
- *2. Connector from Interconnectron GmbH
- *3. A connector is not provided on the Linear Servomotor end. Obtain a connector according to your specifications. Refer to the next page for information on connectors.

■ JZSP-CLN39-□□-E Cables

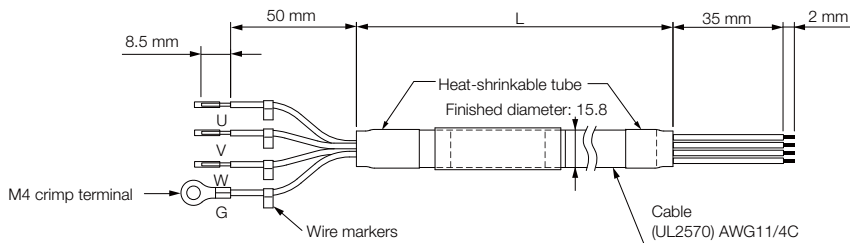

• Wiring Specifications

SERVOPACK Leads		Servomotor Connector	
Wire Color	Signal	Signal	Pin
Red	Phase U	Phase U	A
White	Phase V	Phase V	B
Blue	Phase W	Phase W	C
Green/yellow	FG	FG	D

• JZSP-CLN39 Cable Connectors

Applicable Servomotor	Connector Provided with Servomotor	Plug		Cable Clamp
		Straight	Right-angle	
SGLTW-40 and -80	MS3102A22-22P	MS3106B22-22S or MS3106A22-22S	MS3108B22-22S	MS3057-12A

Linear Servomotors

SGLT (Models with T-type Iron Cores)

- MS3106B22-2S: Straight Plug with Two-piece Shell

Unit: mm

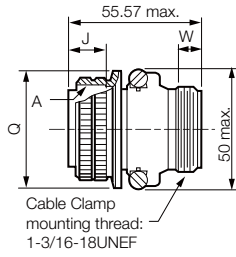

Shell Size	Joint Thread A	Length of Joint J ±0.12	Joint Nut Outer Diameter Q ⁺⁰ / _{-0.38}	Effective Thread Length W min.
22	1-3/8-18UNEF	18.26	40.48	9.53

- MS3106A22-2S: Straight Plug with Solid Shell

Unit: mm

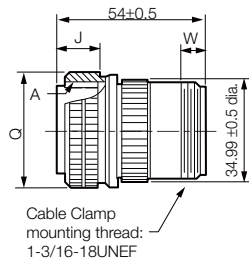

Shell Size	Joint Thread A	Length of Joint J ±0.12	Joint Nut Outer Diameter Q ⁺⁰ / _{-0.38}	Effective Thread Length W min.
22	1-3/8-18UNEF	18.26	40.48	9.53

- MS3108B22-2S: Right-angle Plug with Two-piece Shell

Unit: mm

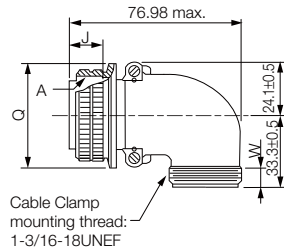

Shell Size	Joint Thread A	Length of Joint J ± 0.12	Joint Nut Outer Diameter Q ⁺⁰ / _{-0.38}	Effective Thread Length W min.
22	1-3/8-18UNEF	18.26	40.48	9.53

- Dimensional Drawings: MS3057-12A Cable Clamp with Rubber Bushing

Unit: mm

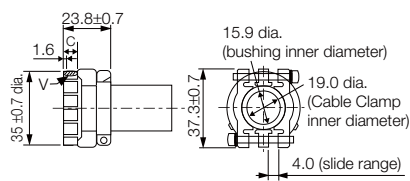

Applicable Connector Shell Size	Effective Thread Length C	Mounting Thread V	Attached Bushing
20.22	10.3	1-3/16-18UNEF	AN3420-12

MEMO

Recommended Linear Encoders and Cables

Recommended Linear Encoders

Incremental Linear Encoders

◆ 1 Vp-p Analog Voltage

You must also use a Yaskawa Serial Converter Unit. The output signal will be multiplied by 8 bits (256 divisions) or 12 bits (4,096 divisions) in the Serial Converter Unit.

Manufacturer	Linear Encoder Type	Model			Linear Encoder Pitch [μm]	Resolution [nm]	Maximum Speed* ¹ [m/s]	Support for Polarity Sensor Input	Application to Linear Servomotors	Application to Fully-Closed Loop Control	Reference
		Scale	Sensor Head	Relay Device between SERVOPACK and Linear Encoder* ³							
Heidenhain Corporation	Exposed	LIDA48□		JZDP-H003/-H006	20	78.1	5	✓	✓	✓	page 310
				JZDP-J003/-J006		4.9	2	✓	✓	*4	page 311
		LIF48□		JZDP-H003/-H006	4	15.6	1	✓	✓	✓	page 310
				JZDP-J003/-J006		1.0	0.4	✓	*4	*4	page 311
Renishaw plc* ²	Exposed	RGS20	RGH22B	JZDP-H005/-H008	20	78.1	5	✓	✓	✓	page 313
				JZDP-J005/-J008		4.9	2	✓	✓	*4	page 314

✓: Applicable

*1. The maximum speeds given in the above table are the maximum applicable speeds of the encoders when combined with a Yaskawa SERVOPACK.

The actual speed will be restricted by either the maximum speed of the Linear Servomotor or the maximum speed of the Linear Encoder (given above).

*2. If you use the origin signals with a Linear Encoder from Renishaw plc, the origin may sometimes be falsely detected. If that occurs, use the BID/DIR signal to output the origin signal only in one direction.

*3. These are the models of Serial Converter Units.

*4. Contact your Yaskawa representative.

Note: Confirm detailed specifications, such as the tolerances, dimensions, and operating environment, with the manufacturer of the Linear Encoder before you use it.

◆ Encoder for Yaskawa's Serial Interface

The multiplier (number of divisions) depends on the Linear Encoder. Also, you must write the Servomotor constant file to the Linear Encoder in advance.

Manufacturer	Linear Encoder Type	Model			Linear Encoder Pitch [μm]	Resolution [nm]	Maximum Speed* ¹ [m/s]	Support for Polarity Sensor Input	Application to Linear Servomotors	Application to Fully-Closed Loop Control	Reference				
		Scale	Sensor Head	Relay Device between SERVOPACK and Linear Encoder											
Magnescale Co., Ltd.	Exposed	SL7□0		PL101-RY* ²	800	97.7	10	–	✓	✓	page 316				
				PL101				MJ620-T13* ³	✓	✓	*4	page 317			
		SQ10	PQ10	MQ10-FLA	400	48.83	3	–	✓	✓	page 319				
				MQ10-GLA				✓	✓	–					
	Sealed				–	80	9.8	3.33	–	✓	✓	page 321			
					–				80	78.1	3.33		–	✓	✓
					–				80	9.8	3.33		–	✓	✓
					–				80	78.1	3.33		–	✓	✓

✓: Applicable

*1. The maximum speeds given in the above table are the maximum applicable speeds of the encoders when combined with a Yaskawa SERVOPACK.

The actual speed will be restricted by either the maximum speed of the Linear Servomotor or the maximum speed of the Linear Encoder (given above).

*2. This is the model of the Sensor Head with Interpolator.

*3. This is the model of the Interpolator.

*4. Contact your Yaskawa representative.

Note: Confirm detailed specifications, such as the tolerances, dimensions, and operating environment, with the manufacturer of the Linear Encoder before you use it.

Absolute Linear Encoders

◆ Encoder for Yaskawa's Serial Interface

The multiplier (number of divisions) depends on the Linear Encoder. Also, you must write the Servomotor constant file to the Linear Encoder in advance.

Manufacturer	Linear Encoder Type	Model			Linear Encoder Pitch* ¹ [μm]	Resolution [nm]	Maximum Speed* ² [m/s]	Support for Polarity Sensor Input	Application to Linear Servomotors	Application to Fully-Closed Loop Control	Reference
		Scale	Sensor Head	Relay Device between SERVOPACK and Linear Encoder							
Magnescape Co., Ltd.	Sealed	SR77-□□□□□LF	–	–	80	9.8	3.33	–	✓	✓	page 321
		SR77-□□□□□MF	–	–	80	78.1	3.33	–	✓	✓	
		SR87-□□□□□LF	–	–	80	9.8	3.33	–	✓	✓	
		SR87-□□□□□MF	–	–	80	78.1	3.33	–	✓	✓	
Mitutoyo Corporation	Exposed	ST781A	–	–	256	500	5	–	✓	✓	page 322
		ST782A	–	–	256	500	5	–	✓	✓	
		ST783A	–	–	51.2	100	5	–	✓	✓	
		ST784A	–	–	51.2	100	5	–	✓	✓	
		ST788A	–	–	51.2	100	5	–	✓	✓	
		ST789A* ³	–	–	25.6	50	5	–	✓	✓	
		ST1381	–	–	5.12	10	8	–	✓	✓	
Heidenhain Corporation	Exposed	LIC4100 Series	EIB3391Y* ⁵	20.48	5	10	–	✓	✓	page 312	
	Sealed	LC115		40.96	10	3	–	✓	✓		
Renishaw plc	Exposed	EL36Y-□□050F□□□	–	–	12.8	50	100	–	✓	✓	page 315
		EL36Y-□□100F□□□	–	–	25.6	100	100	–	✓	✓	
		EL36Y-□□500F□□□	–	–	128	500	100	–	✓	✓	

✓: Applicable

- *1. These are reference values for setting SERVOPACK parameters. Contact the manufacturer for actual linear encoder scale pitches.
- *2. The maximum speeds given in the above table are the maximum applicable speeds of the encoders when combined with a Yaskawa SERVOPACK.
The actual speed will be restricted by either the maximum speed of the Linear Servomotor or the maximum speed of the Linear Encoder (given above).
- *3. Contact Mitutoyo Corporation for details on the Linear Encoders.
- *4. The speed is restricted for some SERVOPACKs.
- *5. This is the model of the Interpolator.

Note: Confirm detailed specifications, such as the tolerances, dimensions, and operating environment, with the manufacturer of the Linear Encoder before you use it.

Connections to Linear Encoder from Heidenhain Corporation

◆ Connections for a 1 Vp-p Analog Voltage Output Signal

You must make the connections through a Yaskawa Serial Converter Unit. The output signal will be multiplied by 8 bits (256 divisions) or 12 bits (4,096 divisions) in the Serial Converter Unit.

■ Connecting to a Linear Servomotor with a Polarity Sensor

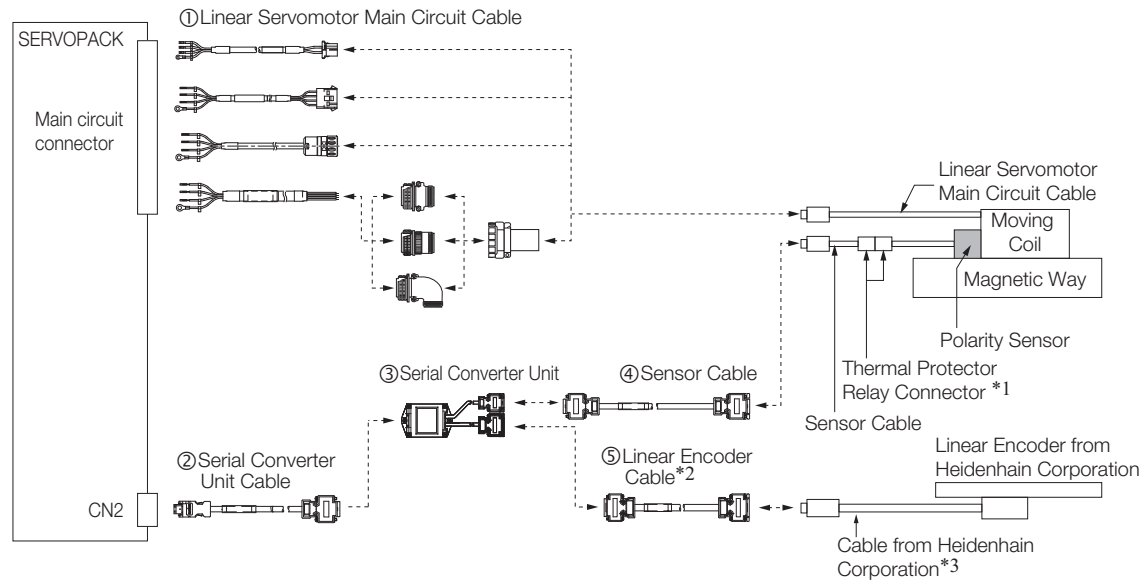

*1. Only SGLFW2 Servomotors come equipped with Thermal Protector Relay Connectors.

*2. When using a JZDP-J00□-□□□ Serial Converter Unit, do not use a Yaskawa Linear Encoder Cable that is longer than 3 m.

*3. Contact Heidenhain Corporation for details on cables (analog 1 Vp-p output, D-sub 15-pin, male) from Heidenhain Corporation.

■ Connecting to a Linear Servomotor without a Polarity Sensor

Servomotors Other Than the SGLFW2

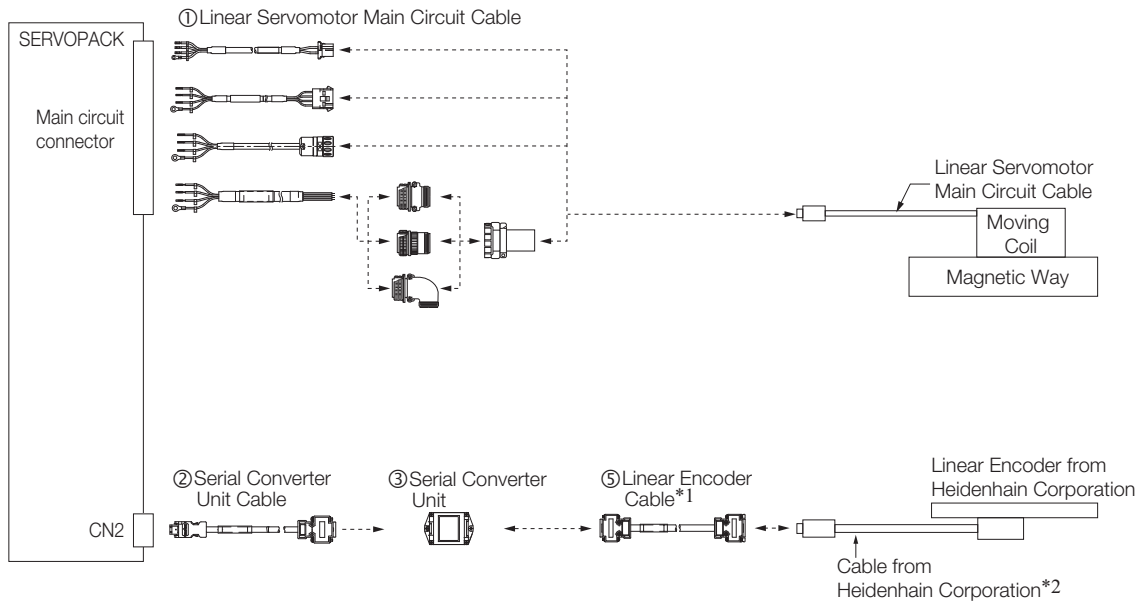

- *1. When using a JZDP-J00□-□□□ Serial Converter Unit, do not use a Yaskawa Linear Encoder Cable that is longer than 3 m.
- *2. Contact Heidenhain Corporation for details on cables (analog 1 Vp-p output, D-sub 15-pin, male) from Heidenhain Corporation.

SGLFW2 Servomotors

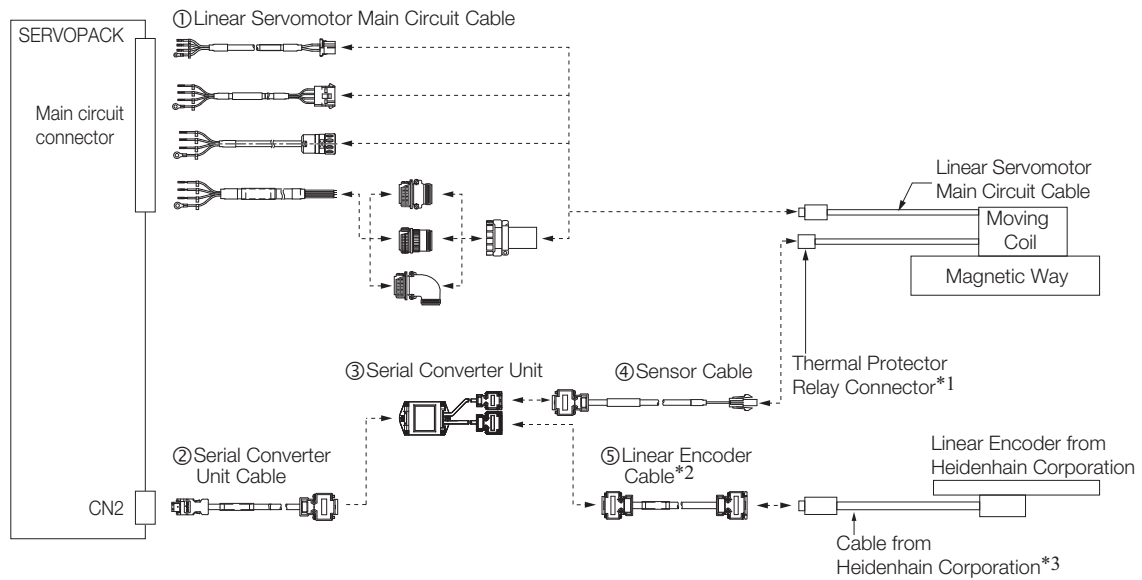

- *1. Only SGLFW2 Servomotors come equipped with Thermal Protector Relay Connectors.
- *2. When using a JZDP-J00□-□□□ Serial Converter Unit, do not use a Yaskawa Linear Encoder Cable that is longer than 3 m.
- *3. Contact Heidenhain Corporation for details on cables (analog 1 Vp-p output, D-sub 15-pin, male) from Heidenhain Corporation.

No.	Cable Type	Reference		
		SGLG	SGLF	SGLT
①	Linear Servomotor Main Circuit Cable	page 241	page 281	page 305
②	Serial Converter Unit Cable	page 324		
③	Serial Converter Unit	page 323		
④	Sensor Cable	page 324		
⑤	Linear Encoder Cable	page 324		

◆ LIC4100 and LC115 Linear Encoder with EIB3391Y Interpolator



Important

1. You cannot use an LIC4100 and LC115 Linear Encoder together with a Linear Servomotor with a Polarity Sensor.
2. If you use an SGLFW2 Servomotor, input the thermal protector signal from the Linear Servomotor to the host controller. The thermal protector signal is closed when the temperature is normal and open when the thermal protector is activated. Do not exceed 3 A or 30 V.

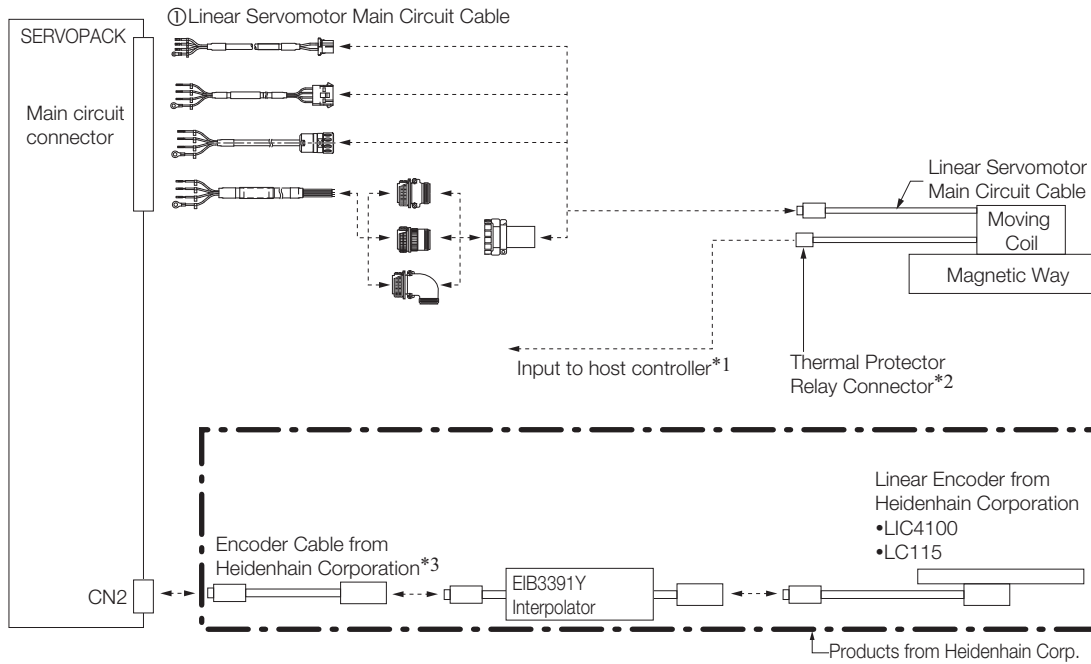

*1. Cables to connect to the host controller are not provided by Yaskawa.

Refer to the following manual for information on connector models.

 *Σ-7-Series AC Servo Drive Peripheral Device Selection Manual* (Manual No.: SIEP S800001 32)

*2. Only SGLFW2 Servomotors come equipped with Thermal Protector Relay Connectors.

*3. Use an Encoder Cable from Heidenhain Corporation. Contact Heidenhain Corporation for detailed Encoder Cable specifications.

No.	Cable Type	Reference		
		SGLG	SGLF	SGLT
①	Linear Servomotor Main Circuit Cable	page 241	page 281	page 305

Connections to Linear Encoder from Renishaw plc

◆ Connections for a 1 Vp-p Analog Voltage Output Signal

You must make the connections through a Yaskawa Serial Converter Unit. The output signal will be multiplied by 8 bits (256 divisions) or 12 bits (4,096 divisions) in the Serial Converter Unit.

■ Connecting to a Linear Servomotor with a Polarity Sensor

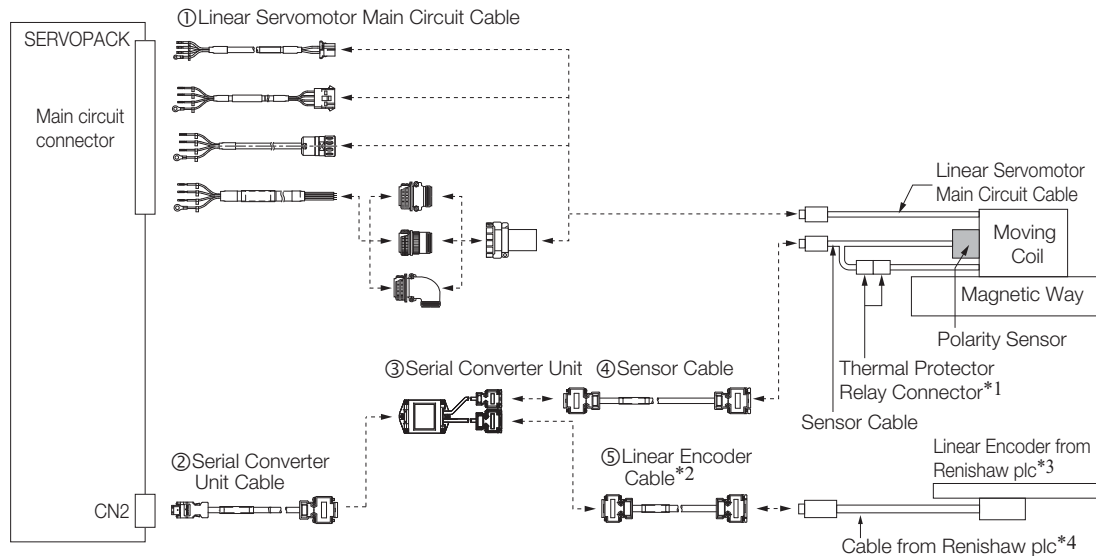

*1. Only SGLFW2 Servomotors come equipped with Thermal Protector Relay Connectors.

*2. When using a JZDP-J00□-□□□ Serial Converter Unit, do not use a Yaskawa Linear Encoder Cable that is longer than 3 m.

*3. If you use the origin signals with a Linear Encoder from Renishaw plc, the origin may sometimes be falsely detected.
If that occurs, use the BID/DIR signal to output the origin signal only in one direction.

*4. Contact Renishaw plc for details on cables (analog 1 Vp-p output, D-sub 15-pin, male) from Renishaw plc. However, the BID and DIR signals are not connected.

■ Connecting to a Linear Servomotor without a Polarity Sensor

Servomotors Other Than the SGLFW2

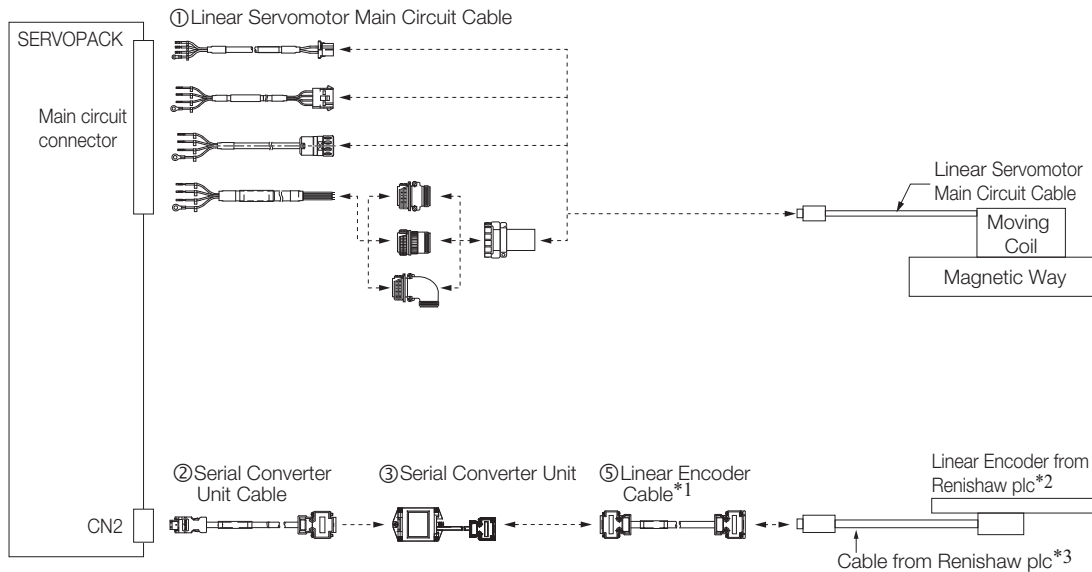

- *1. When using a JZDP-J00□-□□□ Serial Converter Unit, do not use a Yaskawa Linear Encoder Cable that is longer than 3 m.
- *2. If you use the origin signals with a Linear Encoder from Renishaw plc, the origin may sometimes be falsely detected. If that occurs, use the BID/DIR signal to output the origin signal only in one direction.
- *3. Contact Renishaw plc for details on cables (analog 1 Vp-p output, D-sub 15-pin, male) from Renishaw plc. However, the BID and DIR signals are not connected.

SGLFW2 Servomotors

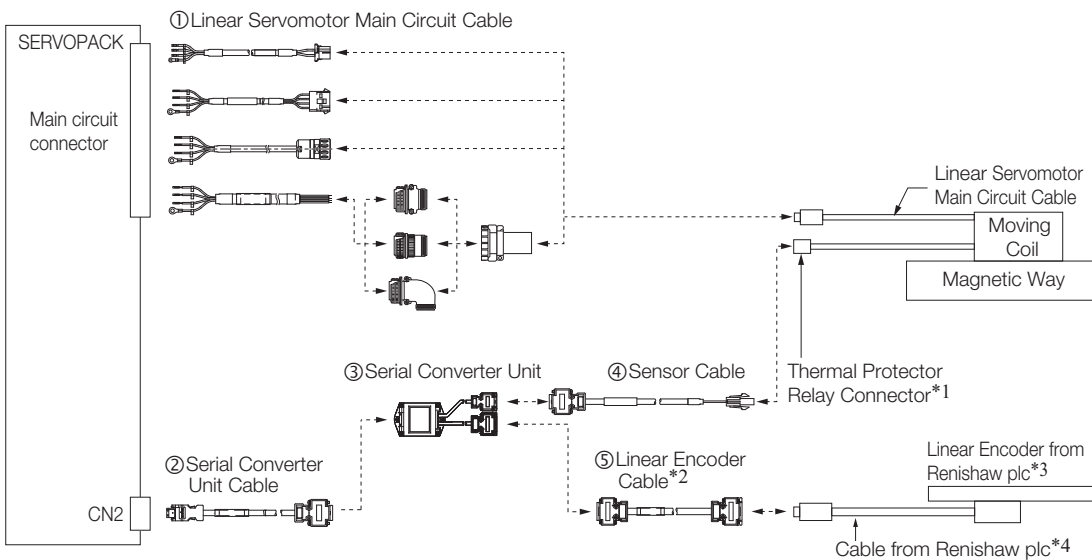

- *1. Only SGLFW2 Servomotors come equipped with Thermal Protector Relay Connectors.
- *2. When using a JZDP-J00□-□□□ Serial Converter Unit, do not use a Yaskawa Linear Encoder Cable that is longer than 3 m.
- *3. If you use the origin signals with a Linear Encoder from Renishaw plc, the origin may sometimes be falsely detected. If that occurs, use the BID/DIR signal to output the origin signal only in one direction.
- *4. Contact Renishaw plc for details on cables (analog 1 Vp-p output, D-sub 15-pin, male) from Renishaw plc. However, the BID and DIR signals are not connected.

No.	Cable Type	Reference		
		SGLG	SGLF	SGLT
①	Linear Servomotor Main Circuit Cable	page 241	page 281	page 305
②	Serial Converter Unit Cable		page 324	
③	Serial Converter Unit		page 323	
④	Sensor Cable		page 324	
⑤	Linear Encoder Cable		page 324	

◆ EVOLUTE Series Linear Encoder (model: EL36Y-□□□□□□□□□)



1. You cannot use an EVOLUTE Series Linear Encoder together with a Linear Servomotor with a Polarity Sensor.
2. If you use an SGLFW2 Servomotor, input the thermal protector signal from the Linear Servomotor to the host controller. The thermal protector signal is closed when the temperature is normal and open when the thermal protector is activated. Do not exceed 3 A or 30 V.

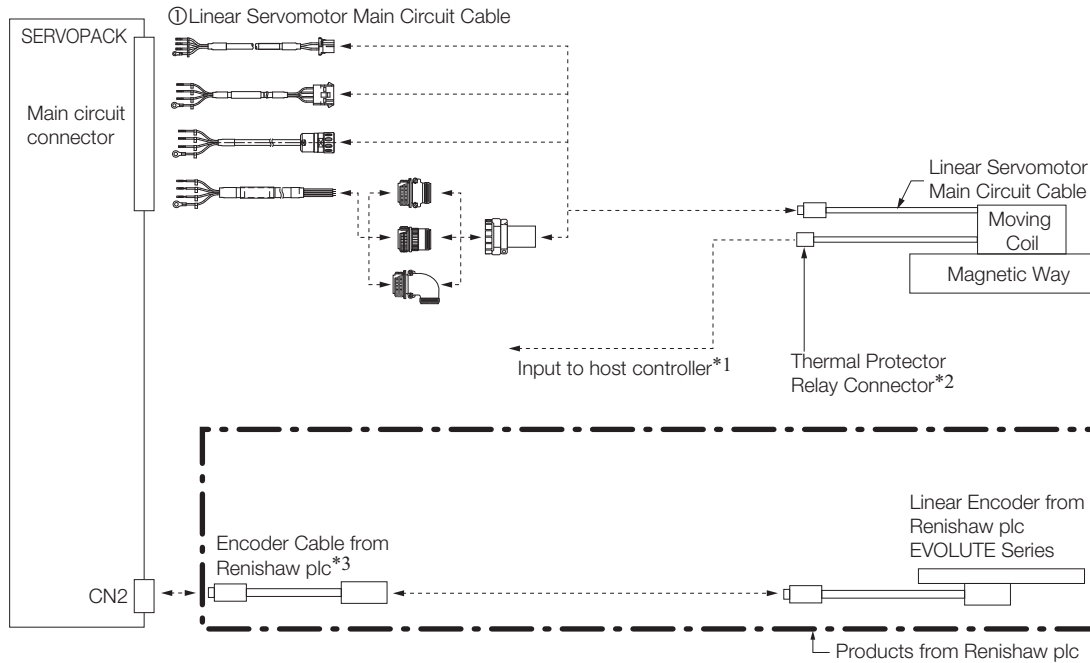

*1. Cables to connect to the host controller are not provided by Yaskawa.

Refer to the following manual for information on connector models.

📖 *Σ-7-Series AC Servo Drive Peripheral Device Selection Manual* (Manual No.: SIEP S800001 32)

*2. Only SGLFW2 Servomotors come equipped with Thermal Protector Relay Connectors.

*3. Use an Encoder Cable from Renishaw plc. Contact Renishaw plc for detailed Encoder Cable specifications.

No.	Cable Type	Reference		
		SGLG	SGLF	SGLT
①	Linear Servomotor Main Circuit Cable	page 241	page 281	page 305

Connections to Linear Encoder from Magnescale Co., Ltd.

◆ SL7□0 Linear Encoder and PL101-RY Sensor Head with Interpolator

Important

1. You cannot use a PL101-RY Sensor Head with an Interpolator together with a Linear Servomotor with a Polarity Sensor.
2. If you use an SGLFW2 Servomotor, input the thermal protector signal from the Linear Servomotor to the host controller. The thermal protector signal is closed when the temperature is normal and open when the thermal protector is activated. Do not exceed 3 A or 30 V.

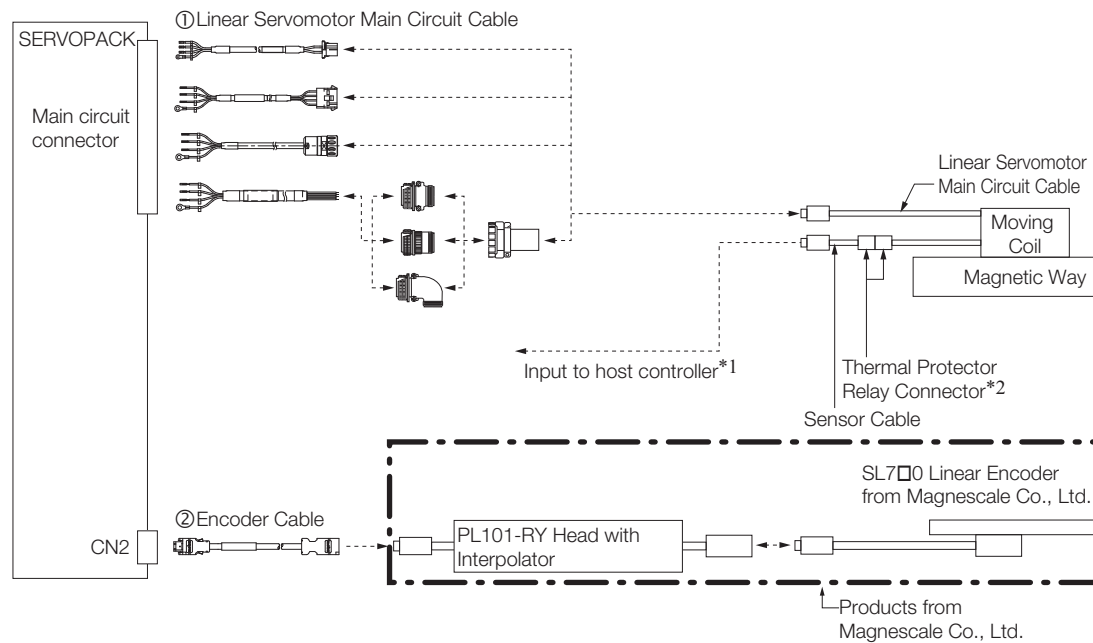

*1. Cables to connect to the host controller are not provided by Yaskawa.

Refer to the following manual for information on connector models.

Σ-7-Series AC Servo Drive Peripheral Device Selection Manual (Manual No.: SIEP S800001 32)

*2. Only SGLFW2 Servomotors come equipped with Thermal Protector Relay Connectors.

No.	Cable Type	Reference		
		SGLG	SGLF	SGLT
①	Linear Servomotor Main Circuit Cable	page 241	page 281	page 305
②	Encoder Cable	Refer to the below.		

■ Encoder Cable

Name	Length (L)	Order Number		Appearance
		Standard Cable	Flexible Cable*	
Cable with Connectors on Both Ends	3 m	JZSP-CMP00-03-E	JZSP-CMP10-03-E	
	5 m	JZSP-CMP00-05-E	JZSP-CMP10-05-E	
	10 m	JZSP-CMP00-10-E	JZSP-CMP10-10-E	
	15 m	JZSP-CMP00-15-E	JZSP-CMP10-15-E	
	20 m	JZSP-CMP00-20-E	JZSP-CMP10-20-E	

* Use Flexible Cables for moving parts of machines, such as robots.

The recommended bending radius (R) is 68 mm or larger.

◆ SL7□0 Linear Encoder, PL101 Sensor Head, and MJ620-T13 Interpolator

Important

1. A 5-VDC power supply is required for the MJ620-T13. (The 5-VDC power supply is not provided by Yaskawa.)
2. Refer to the MJ620-T13 specifications from Magnescale Co., Ltd. for the current consumption of the MJ620-T13.
3. If you use an SGLFW2 Servomotor, remove the thermal protector relay connector and input the thermal protector signal from the Linear Servomotor to the host controller. The thermal protector signal is closed when the temperature is normal and open when the thermal protector is activated. Do not exceed 3 A or 30 V.

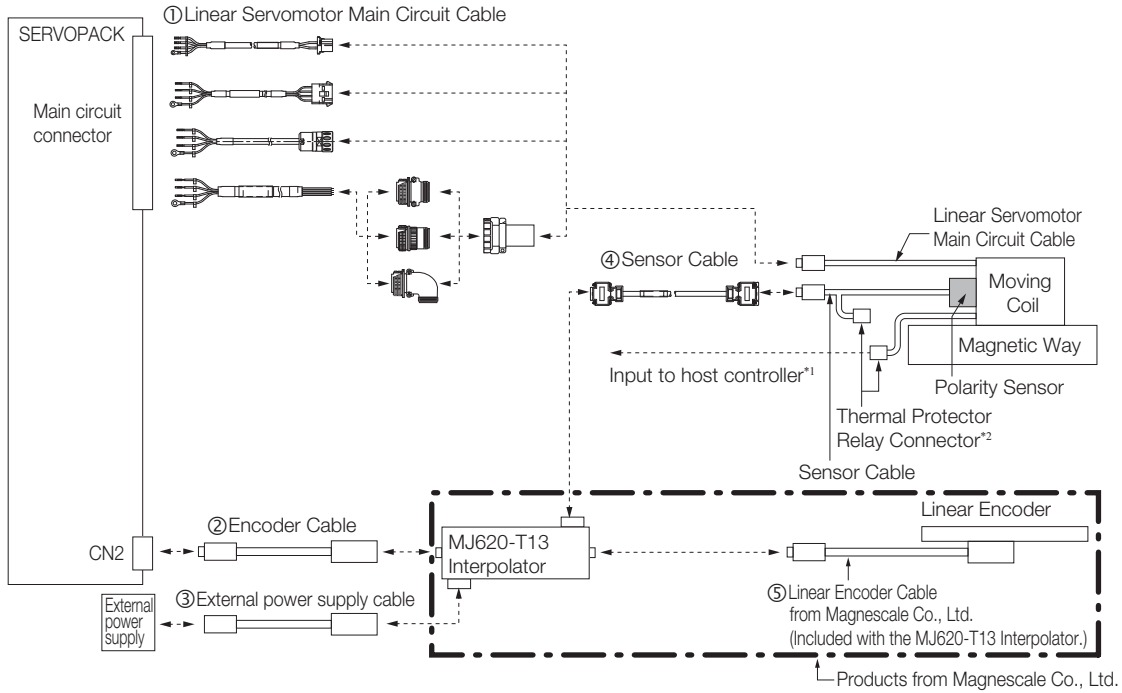

*1. Cables to connect to the host controller are not provided by Yaskawa. Refer to the following manual for information on connector models.
 ①-7-Series AC Servo Drive Peripheral Device Selection Manual (Manual No.: SIEP S800001 32)

*2. Only SGLFW2 Servomotors come equipped with Thermal Protector Relay Connectors.

No.	Cable Type	Reference		
		SGLG	SGLF	SGLT
①	Linear Servomotor Main Circuit Cable	page 241	page 281	page 305
②	Encoder Cable	page 318		
③	External power supply cable	page 318		
④	Sensor Cable	page 324		
⑤	Linear Encoder Cable	Use the cables that come with the MJ620-T13 Interpolator. For details, refer to the specifications for the MJ620-T13 Interpolator.		

Linear Servomotors

Recommended Linear Encoders and Cables

■ Encoder Cables

These cables are not provided by Yaskawa. Use a shielded cable. Refer to the following tables for the pin layouts.

SERVOPACK End of Cable (CN2)

- Plug Connector: 55100-0670 (Molex Japan LLC)
- Connector order number: JZSP-CMP9-1-E (SERVOPACK Connector Kit)

Pin	Signal	Function
1	PG+5 V	Encoder power supply +5 V
2	PG0 V	Encoder power supply 0 V
3	–	–
4	–	–
5	PS	Serial data
6	/PS	
Shell	Shield	–

MJ620-T13 End of Cable

For details, refer to the specifications for the MJ620-T13 from Magnescale Co., Ltd..

- Receptacle: PCR-E20LMD+ (Honda Tsushin Kogyo Co., Ltd.)
- Plug: PCR-E20FS+ (Honda Tsushin Kogyo Co., Ltd.)
- Shell: PCS-E20L□ (Honda Tsushin Kogyo Co., Ltd.)

Pin	Signal	Function	Pin	Signal	Function
1	Do not connect.	–	12	0 V	0 V
2	Do not connect.	–	13	Do not connect.	–
3	Do not connect.	–	14	0 V	0 V
4	Do not connect.	–	15	Do not connect.	–
5	SD	Serial data	16	0 V	0 V
6	/SD		17	Do not connect.	–
7	Do not connect.	–	18	Do not connect.	–
8	Do not connect.	–	19	Do not connect.	–
9	Do not connect.	–	20	Do not connect.	–
10	Do not connect.	–	Shell	Shield	–
11	Do not connect.	–			

Cables without Connectors

Name	Length (L)	Order Number	
		Standard Cable	Flexible Cable
Cables without Connectors	5 m	JZSP-CMP09-05-E	JZSP-CSP39-05-E
	10 m	JZSP-CMP09-10-E	JZSP-CSP39-10-E
	15 m	JZSP-CMP09-15-E	JZSP-CSP39-15-E
	20 m	JZSP-CMP09-20-E	JZSP-CSP39-20-E

Note: We recommend that you use Flexible Cables.

■ External Power Supply Cables

This cable is not provided by Yaskawa. Refer to the table on the right for the pin layout.

For details, refer to the specifications for the MJ620-T13 from Magnescale Co., Ltd..

- Connector Header: MC1.5/2-GF-3.81 (Phoenix Contact)
- Connector Plug: MC1.5/2-STF-3.81 (Phoenix Contact)

Pin	Signal	Function
1	+5 V	+5 V
2	0 V	0 V

◆ SmartSCALE Linear Encoder (SQ10 Scale + MQ10-□LA Interpolator)



Important

If you use an SGLFW2 Servomotor, remove the thermal protector relay connector and input the thermal protector signal from the Linear Servomotor to the host controller. The thermal protector signal is closed when the temperature is normal and open when the thermal protector is activated. Do not exceed 3 A or 30 V.

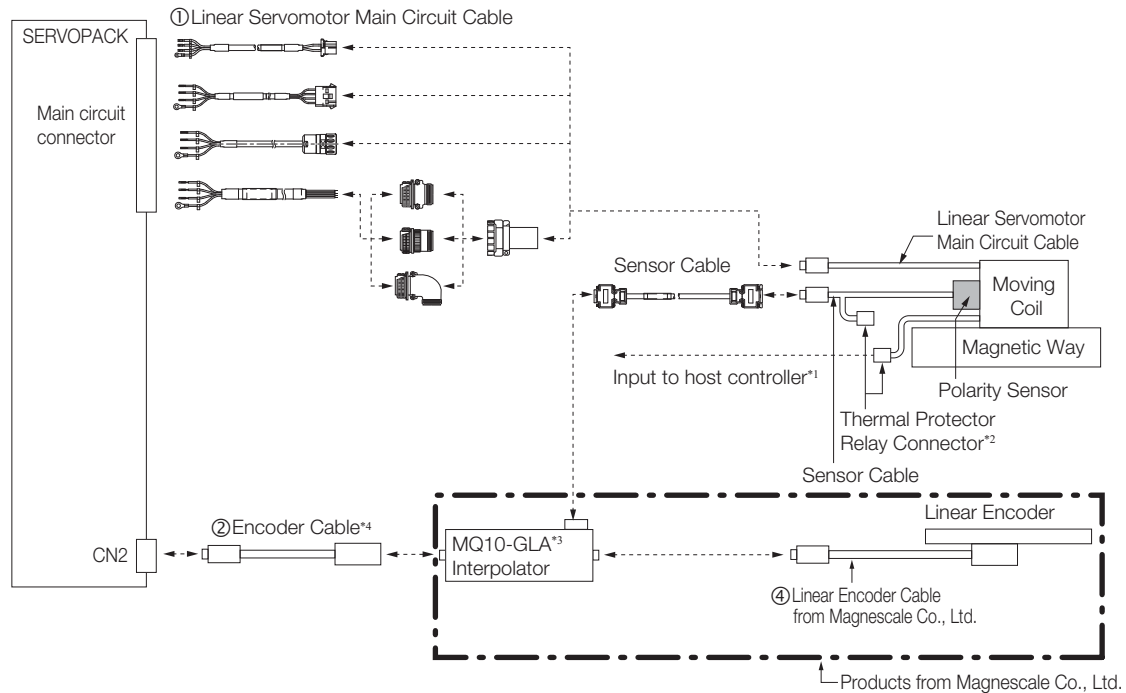

*1. Cables to connect to the host controller are not provided by Yaskawa. Refer to the following manual for information on connector models.

📖 *Σ-7-Series AC Servo Drive Peripheral Device Selection Manual (Manual No.: SIEP S800001 32)*

*2. Only SGLFW2 Servomotors come equipped with Thermal Protector Relay Connectors.

*3. This cable configurations shown above is the connection when you use the MQ10-GLA interpolator with polarity sensor.

*4. The maximum length of the Serial Converter Unit Cable is 15 m.

No.	Cable Type	Reference		
		SGLG	SGLF	SGLT
①	Linear Servomotor Main Circuit Cable	page 241	page 281	page 305
②	Encoder Cable	page 320		
③	Sensor Cable	page 324		
④	Linear Encoder Cable	Use the cables that come with the MQ10-□LA Interpolator. For details, refer to the specifications for the MQ10-□LA Interpolator.		

Linear Servomotors

Recommended Linear Encoders and Cables

■ Encoder Cables

These cables are not provided by Yaskawa. Use a shielded cable. Refer to the following tables for the pin layouts.

SERVOPACK End of Cable (CN2)

- Plug Connector: 55100-0670 (Molex Japan LLC)
- Connector order number: JZSP-CMP9-1-E (SERVOPACK Connector Kit)

Pin	Signal	Function
1	PG+5 V	Encoder power supply +5 V
2	PG0 V	Encoder power supply 0 V
3	–	–
4	–	–
5	PS	Serial data
6	/PS	
Shell	Shield	–

MQ10-□LA End of Cable

For details, refer to the specifications for the MQ10-□LA from Magnescale Co., Ltd..

Cables without Connectors

Name	Length (L)	Order Number	
		Standard Cable	Flexible Cable
Cables without Connectors	5 m	JZSP-CMP09-05-E	JZSP-CSP39-05-E
	10 m	JZSP-CMP09-10-E	JZSP-CSP39-10-E
	15 m	JZSP-CMP09-15-E	JZSP-CSP39-15-E

Note: We recommend that you use Flexible Cables.

◆ SR-75, SR-77, SR-85, and SR-87 Linear Encoders

Important

1. You cannot use an SR-75, SR-77, SR-85, or SR-87 Linear Encoder with a Linear Servomotor with a Polarity Sensor.
2. If you use an SGLFW2 Servomotor, input the thermal protector signal from the Linear Servomotor to the host controller. The thermal protector signal is closed when the temperature is normal and open when the thermal protector is activated. Do not exceed 3 A or 30 V.

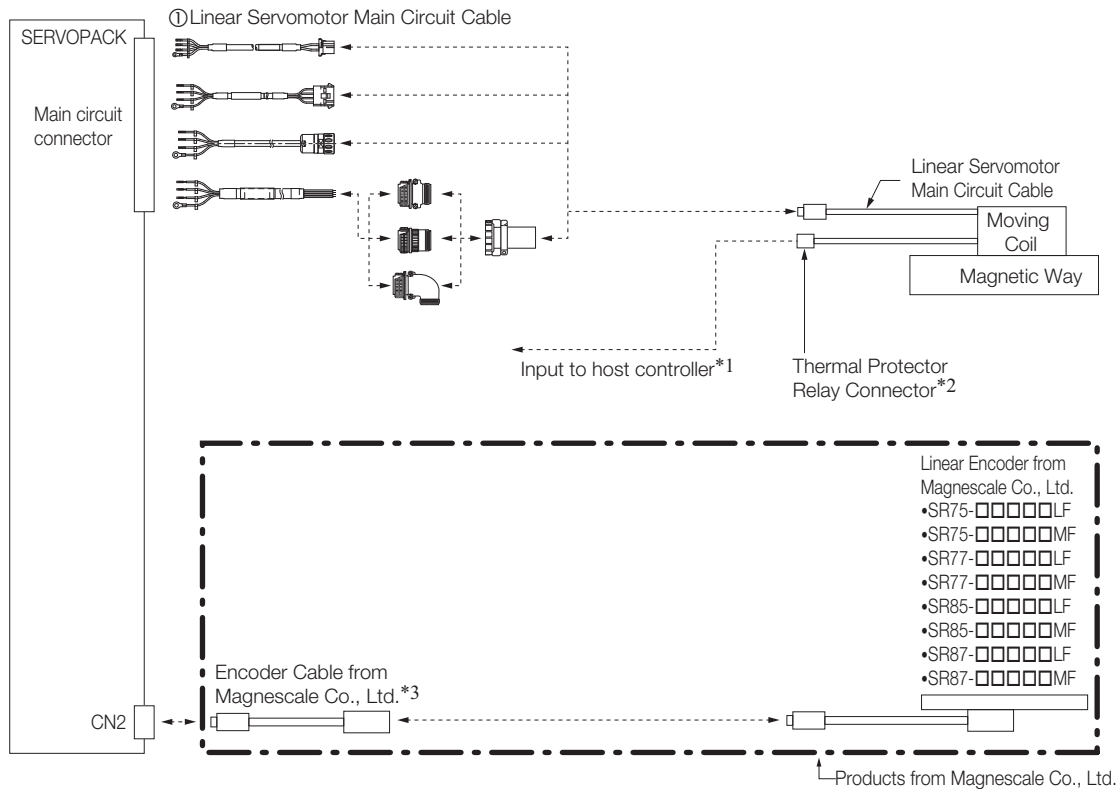

*1. Cables to connect to the host controller are not provided by Yaskawa. Refer to the following manual for information on connector models.

☞ *Σ-7-Series AC Servo Drive Peripheral Device Selection Manual* (Manual No.: SIEP S800001 32)

*2. Only SGLFW2 Servomotors come equipped with Thermal Protector Relay Connectors.

*3. To connect the SERVOPACK and Linear Encoder, use a CH33-xx□□G Cable from Magnescale Co., Ltd. (This cable has connectors designed for use with Yaskawa products.)

No.	Cable Type	Reference		
		SGLG	SGLF	SGLT
①	Linear Servomotor Main Circuit Cable	page 241	page 281	page 305

Connections to Linear Encoders from Mitutoyo Corporation

◆ ST78□A/ST13□□ Linear Encoders



1. You cannot use a ST78□A Linear Encoder together with a Linear Servomotor with a Polarity Sensor.
2. If you use an SGLFW2 Servomotor, input the thermal protector signal from the Linear Servomotor to the host controller. The thermal protector signal is closed when the temperature is normal and open when the thermal protector is activated. Do not exceed 3 A or 30 V.

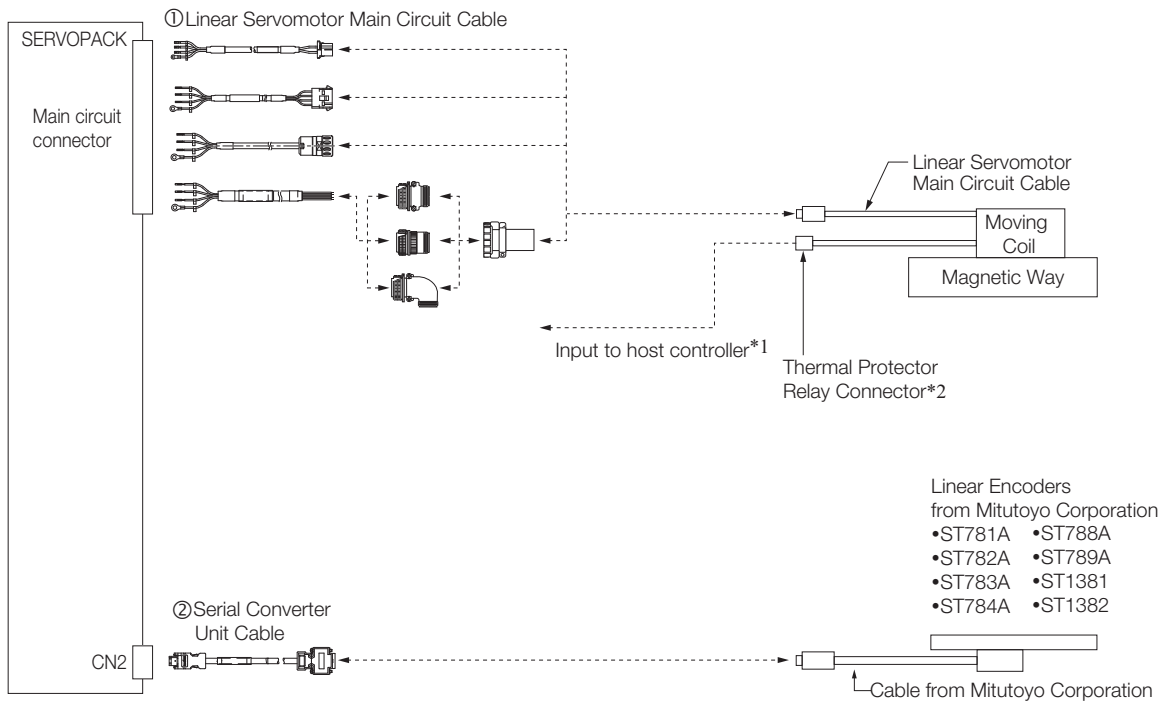

*1. Cables to connect to the host controller are not provided by Yaskawa.
Refer to the following manual for information on connector models.

Σ-7-Series AC Servo Drive Peripheral Device Selection Manual (Manual No.: SIEP S800001 32)

*2. Only SGLFW2 Servomotors come equipped with Thermal Protector Relay Connectors.

No.	Cable Type	Reference		
		SGLG	SGLF	SGLT
①	Linear Servomotor Main Circuit Cable	page 241	page 281	page 305
②	Serial Converter Unit Cable	page 324		

Serial Converter Units

Order Number

Use the following tables to select the Serial Converter Unit.

JZDP - -

Serial Converter Unit Model					Applicable Linear Servomotor					
Code	Appearance	Applicable Linear Encoder	Polarity Sensor	Thermal Protector	Servomotor Model	Code	Servomotor Model	Code		
H003 J003		From Heidenhain Corp.	None	None	SGLGW - (coreless models) For Standard-force Magnetic Way	30A050C	250	SGLFW2- (models with F-type iron cores)	30A070A	628
						30A080C	251		30A120A	629
40A140C	252	30A230A	630							
40A253C	253	45A200A	631							
40A365C	254	45A380A	632							
60A140C	258	90A200A	633							
60A253C	259	90A380A	634							
60A365C	260	90A560A	648							
90A200C	264	1DA380A	649							
90A370C	265	1DA560A	650							
H005 J005		From Renishaw PLC	None	None	SGLGW - + SGLGM - <input type="text"/> -M (coreless models) For High-force Mag- netic Way	90A535C	266	SGLTW- (models with T- type iron cores)	20A170A	011
						40A140C	255		20A320A	012
40A253C	256	20A460A	013							
40A365C	257	35A170A	014							
60A140C	261	35A320A	015							
60A253C	262	35A460A	016							
60A365C	263	35A170H	105							
20A090A	017	35A320H	106							
20A120A	018	50A170H	108							
35A120A	019	50A320H	109							
H006 J006		From Heidenhain Corp.	Yes	Yes	SGLFW- (models with F-type iron cores)	35A230A	020	40A400B	185	
						50A200B	181	40A600B	186	
						50A380B	182	80A400B	187	
						1ZA200B	183	80A600B	188	
						1ZA380B	184			
H008 J008		From Renishaw PLC	Yes	Yes						

Note: 1. Refer to the following manual for detailed specifications of the Serial Converter Units.

Σ-7-Series AC Servo Drive Peripheral Device Selection Manual (Manual No.: SIEP S800001 32)

2. Contact your Yaskawa representative for information on the water cooling specifications of the SGLFW2.

Serial Converter Unit Cables

Linear Servomotor Model	Length (L)	Order Number	Appearance
All Models	1 m	JZSP-CLP70-01-E	
	3 m	JZSP-CLP70-03-E	
	5 m	JZSP-CLP70-05-E	
	10 m	JZSP-CLP70-10-E	
	15 m	JZSP-CLP70-15-E	
	20 m	JZSP-CLP70-20-E	

Sensor Cables

Linear Servomotor Model	Length (L)	Order Number	Appearance
SGLGW-□□A SGLFW-□□A SGLTW-□□A	1 m	JZSP-CLL10-01-E	
	3 m	JZSP-CLL10-03-E	
	5 m	JZSP-CLL10-05-E	
	10 m	JZSP-CLL10-10-E	
	15 m	JZSP-CLL10-15-E	
SGLFW2-□□A□□□AS□ (With Polarity Sensor)	1 m	JZSP-CL2L100-01-E	
	3 m	JZSP-CL2L100-03-E	
	5 m	JZSP-CL2L100-05-E	
	10 m	JZSP-CL2L100-10-E	
	15 m	JZSP-CL2L100-15-E	
SGLFW2-□□A□□□AT□ (Without Polarity Sensor)	1 m	JZSP-CL2TH00-01-E	
	3 m	JZSP-CL2TH00-03-E	
	5 m	JZSP-CL2TH00-05-E	
	10 m	JZSP-CL2TH00-10-E	
	15 m	JZSP-CL2TH00-15-E	

Linear Encoder Cables

Name	Linear Servomotor Model	Length* (L)	Order Number	Appearance
For linear encoder from Renishaw PLC	All Models	1 m	JZSP-CLL00-01-E	
		3 m	JZSP-CLL00-03-E	
		5 m	JZSP-CLL00-05-E	
		10 m	JZSP-CLL00-10-E	
		15 m	JZSP-CLL00-15-E	
For linear encoder from Heidenhain Corporation		1 m	JZSP-CLL30-01-E	
		3 m	JZSP-CLL30-03-E	
		5 m	JZSP-CLL30-05-E	
		10 m	JZSP-CLL30-10-E	
		15 m	JZSP-CLL30-15-E	

* When using a JZDP-J00□-□□□-E Serial Converter Unit, do not exceed a cable length of 3 m.

SERVOPACKs

■ Features

Σ -7S SERVOPACKs (Single-axis)



Analog Voltage/Pulse Train Reference Type 326

- 3.1 kHz response frequency and improved vibration suppression



MECHATROLINK-II Communications

Reference Type..... 336

- High-precision motion control.
- 3.1 kHz response frequency and improved vibration suppression



MECHATROLINK-III Communications

Reference Type..... 346

- Real-time communication (communication speed: 100 Mbps).
- High-precision motion control.
- 3.1 kHz response frequency and improved vibration suppression



INDEXER Module-Mounted Type 356

- Simple connection to the host controller with the I/O module.
- Reliable high-speed, high-precision positioning.
- Motion control without use of motion controllers.



DeviceNet Module-Mounted Type 370

- Compliant with the communication specifications of the DeviceNet open field network.
- Monitor information from servo drive with the host controller.
- Full range of positioning functions featured.



FT82/FT83 Specification

(SGM7D Motor Drive Type)..... 382

- High torque, high precision, and a user-friendly design.
- FT83 SERVOPACKs with built-in INDEXER.

Σ -7W SERVOPACKs (Two-axis)



MECHATROLINK-III Communications

Reference Type..... 412

- Two axes can be controlled with a SERVOPACK.
- The regenerative energy of multiple axes can be used as the drive energy.

Σ -7C SERVOPACKs

(Two-axis, with built-in Controllers)



Bus Connection Reference Type 420

- Build small-scale equipment system without PLC using one SERVOPACK.
- Expand functionality by mounting an option unit.
- Reduce burden of designing software when part of the equipment changes.

Common

SERVOPACK External Dimensions 436

Peripheral Devices 448

Σ -7S Analog

Σ -7S M-II

Σ -7S M-III

Σ -7S INDEXER

Σ -7S DeviceNet

Σ -7S FT82

Σ -7S FT83

Σ -7W M-III

Σ -7C

SERVOPACK

External Dimensions

Peripheral Devices

Σ-7S Single-axis Analog Voltage/Pulse Train Reference SERVOPACKs

Model Designations

SGD7S - R70 A 00 A 001 000 B

Σ-7 Series
Σ-7S SERVOPACKs

1st+2nd+3rd digits

4th digit

5th+6th digits

7th digit

8th+9th+10th digits

11th+12th+13th digits

14th digit

1st+2nd+3rd digits Maximum Applicable Motor Capacity

Voltage	Code	Specification
Three-phase, 200 VAC	R70*1	0.05 kW
	R90*1	0.1 kW
	1R6*1	0.2 kW
	2R8*1	0.4 kW
	3R8	0.5 kW
	5R5*1	0.75 kW
	7R6	1.0 kW
	120*2	1.5 kW
	180	2.0 kW
	200*3	3.0 kW
	330	5.0 kW
	470	6.0 kW
	550	7.5 kW
	590	11 kW
780	15 kW	
Single-phase, 100 VAC	R70	0.05 kW
	R90	0.1 kW
	2R1	0.2 kW
	2R8	0.4 kW

4th digit Voltage

Code	Specification
A	200 VAC
F	100 VAC

5th+6th digits Interface*4

Code	Specification
00	Analog voltage/pulse train reference

7th digit Design Revision Order

A

8th+9th+10th digits Hardware Options Specification

Code	Specification	Applicable Models
None	Without options	All models
000		
001	Rack-mounted	SGD7S-R70A to -330A SGD7S-R70F to -2R8F
	Duct-ventilated	SGD7S-470A to -780A
002	Varnished	All models
008	Single-phase, 200-VAC power supply input	SGD7S-120A
020*5	No dynamic brake	SGD7S-R70A to -2R8A SGD7S-R70F to -2R8F
	External dynamic brake resistor	SGD7S-3R8A to -780A

11th+12th+13th digits FT/EX Specification

Code	Specification
None	None
000	

14th digit BTO Specification*6 (Available in Japan only)

Code	Specification
None	None
B	BTO Specification

*1. You can use these models with either a single-phase or three-phase power supply input.

*2. A model with a single-phase, 200-VAC power supply input is available as a hardware option (model: SGD7S-120A00A008).

*3. The rated output is 2.4 kW if you combine the SGM7G-30A with the SGD7S-200A.

*4. The same SERVOPACKs are used for both Rotary Servomotors and Linear Servomotors.

*5. Refer to the following manual for details.

📖 *Σ-7-Series AC Servo Drive Σ-7S/Σ-7W SERVOPACK with Hardware Option Specifications Dynamic Brake Product Manual* (Manual No.: SIEP S800001 73)

*6. The BTO specification indicates if the SERVOPACK is customized by using the MechatroCloud BTO service.

You need a BTO number to order SERVOPACKs with customized specifications.

Refer to page M-15 for the details on the BTO service.

Ratings and Specifications

Ratings

◆ Three-phase, 200 VAC

Model SGD7S-		R70A	R90A	1R6A	2R8A	3R8A	5R5A	7R6A	120A	180A	200A	330A	
Maximum Applicable Motor Capacity [kW]		0.05	0.1	0.2	0.4	0.5	0.75	1.0	1.5	2.0	3.0	5.0	
Continuous Output Current [Arms]		0.66	0.91	1.6	2.8	3.8	5.5	7.6	11.6	18.5	19.6	32.9	
Instantaneous Maximum Output Current [Arms]		2.1	3.2	5.9	9.3	11	16.9	17	28	42	56	84.0	
Main Circuit	Power Supply	200 VAC to 240 VAC, -15% to +10%, 50 Hz/60 Hz											
	Input Current [Arms]*	0.4	0.8	1.3	2.5	3.0	4.1	5.7	7.3	10	15	25	
Control	Power Supply	200 VAC to 240 VAC, -15% to +10%, 50 Hz/60 Hz											
	Input Current [Arms]*	0.2	0.2	0.2	0.2	0.2	0.2	0.2	0.2	0.25	0.25	0.3	
Power Supply Capacity [kVA]*		0.2	0.3	0.5	1.0	1.3	1.6	2.3	3.2	4.0	5.9	7.5	
Power Loss*	Main Circuit Power Loss [W]	5.0	7.0	11.9	22.5	28.5	38.9	49.2	72.6	104.2	114.2	226.6	
	Control Circuit Power Loss [W]	12	12	12	12	14	14	14	15	16	16	19	
	Built-in Regenerative Resistor Power Loss [W]	–	–	–	–	8	8	8	10	16	16	36	
	Total Power Loss [W]	17.0	19.0	23.9	34.5	50.5	60.9	71.2	97.6	136.2	146.2	281.6	
Regenerative Resistor	Built-In Regenerative Resistor	Resistance [Ω]	–	–	–	–	40	40	40	20	12	12	8
		Capacity [W]	–	–	–	–	40	40	40	60	60	60	180
	Minimum Allowable External Resistance [Ω]		40	40	40	40	40	40	40	20	12	12	8
Overvoltage Category		III											

* This is the net value at the rated load.

Model SGD7S-		470A	550A	590A	780A	
Maximum Applicable Motor Capacity [kW]		6.0	7.5	11	15	
Continuous Output Current [Arms]		46.9	54.7	58.6	78.0	
Instantaneous Maximum Output Current [Arms]		110	130	140	170	
Main Circuit	Power Supply	200 VAC to 240 VAC, -15% to +10%, 50 Hz/60 Hz				
	Input Current [Arms] ^{*1}	29	37	54	73	
Control	Power Supply	200 VAC to 240 VAC, -15% to +10%, 50 Hz/60 Hz				
	Input Current [Arms] ^{*1}	0.3	0.3	0.4	0.4	
Power Supply Capacity [kVA] ^{*1}		10.7	14.6	21.7	29.6	
Power Loss ^{*1}	Main Circuit Power Loss [W]	271.7	326.9	365.3	501.4	
	Control Circuit Power Loss [W]	21	21	28	28	
	External Regenerative Resistor Unit Power Loss [W]	180 ^{*2}	180 ^{*3}	350 ^{*3}	350 ^{*3}	
	Total Power Loss [W]	292.7	347.9	393.3	529.4	
External Regenerative Resistor Unit	External Regenerative Resistor Unit	Resistance [Ω]	6.25 ^{*2}	3.13 ^{*3}	3.13 ^{*3}	3.13 ^{*3}
		Capacity [W]	880 ^{*2}	1760 ^{*3}	1760 ^{*3}	1760 ^{*3}
	Minimum Allowable External Resistance [Ω]		5.8	2.9	2.9	2.9
Overvoltage Category		III				

*1. This is the net value at the rated load.

*2. This value is for the optional JUSP-RA04-E Regenerative Resistor Unit.

*3. This value is for the optional JUSP-RA05-E Regenerative Resistor Unit.

SERVOPACKs

Σ-7S Single-axis Analog Voltage/Pulse Train Reference SERVOPACKs

◆ Single-phase, 200 VAC

Model SGD7S-		R70A	R90A	1R6A	2R8A	5R5A	120A
Maximum Applicable Motor Capacity [kW]		0.05	0.1	0.2	0.4	0.75	1.5
Continuous Output Current [Arms]		0.66	0.91	1.6	2.8	5.5	11.6
Instantaneous Maximum Output Current [Arms]		2.1	3.2	5.9	9.3	16.9	28
Main Circuit	Power Supply	200 VAC to 240 VAC, -15% to +10%, 50 Hz/60 Hz					
	Input Current [Arms]*	0.8	1.6	2.4	5.0	8.7	16
Control	Power Supply	200 VAC to 240 VAC, -15% to +10%, 50 Hz/60 Hz					
	Input Current [Arms]*	0.2	0.2	0.2	0.2	0.2	0.25
Power Supply Capacity [kVA]*		0.2	0.3	0.6	1.2	1.9	4.0
Power Loss*	Main Circuit Power Loss [W]	5.0	7.1	12.1	23.7	39.2	71.8
	Control Circuit Power Loss [W]	12	12	12	12	14	16
	Built-in Regenerative Resistor Power Loss [W]	-	-	-	-	8	16
	Total Power Loss [W]	17.0	19.1	24.1	35.7	61.2	103.8
Regenerative Resistor	Built-In Regenerative Resistor	Resistance [Ω]	-	-	-	40	12
		Capacity [W]	-	-	-	40	60
	Minimum Allowable External Resistance [Ω]	40	40	40	40	40	12
Overvoltage Category		III					

* This is the net value at the rated load.

◆ 270 VDC

Model SGD7S-		R70A	R90A	1R6A	2R8A	3R8A	5R5A	7R6A	120A
Maximum Applicable Motor Capacity [kW]		0.05	0.1	0.2	0.4	0.5	0.75	1.0	1.5
Continuous Output Current [Arms]		0.66	0.91	1.6	2.8	3.8	5.5	7.6	11.6
Instantaneous Maximum Output Current [Arms]		2.1	3.2	5.9	9.3	11.0	16.9	17.0	28.0
Main Circuit	Power Supply	270 VDC to 324 VDC, -15% to +10%							
	Input Current [Arms]* ¹	0.5	1.0	1.5	3.0	3.8	4.9	6.9	11
Control	Power Supply	270 VDC to 324 VDC, -15% to +10%							
	Input Current [Arms]* ¹	0.2	0.2	0.2	0.2	0.2	0.2	0.2	0.2 ²
Power Supply Capacity [kVA]* ¹		0.2	0.3	0.6	1	1.4	1.6	2.3	3.2
Power Loss* ¹	Main Circuit Power Loss [W]	4.4	5.9	9.8	17.5	23.0	30.7	38.7	55.8
	Control Circuit Power Loss [W]	12	12	12	12	14	14	14	15
	Total Power Loss [W]	16.4	17.9	21.8	29.5	37.0	44.7	52.7	70.8
Overvoltage Category		III							

*1. This is the net value at the rated load.

*2. The value is 0.25 Arms for the SGD7S-120A00A008.

Model SGD7S-		180A	200A	330A	470A	550A	590A	780A
Maximum Applicable Motor Capacity [kW]		2.0	3.0	5.0	6.0	7.5	11.0	15.0
Continuous Output Current [Arms]		18.5	19.6	32.9	46.9	54.7	58.6	78.0
Instantaneous Maximum Output Current [Arms]		42.0	56.0	84.0	110	130	140	170
Main Circuit	Power Supply	270 VDC to 324 VDC, -15% to +10%						
	Input Current [Arms]*	14	20	34	36	48	68	92
Control	Power Supply	270 VDC to 324 VDC, -15% to +10%						
	Input Current [Arms]*	0.25	0.25	0.3	0.3	0.3	0.4	0.4
Power Supply Capacity [kVA]*		4.0	5.9	7.5	10.7	14.6	21.7	29.6
Power Loss*	Main Circuit Power Loss [W]	82.7	83.5	146.2	211.6	255.3	243.6	343.4
	Control Circuit Power Loss [W]	16	16	19	21	21	28	28
	Total Power Loss [W]	98.7	99.5	165.2	232.6	276.3	271.6	371.4
Overvoltage Category		III						

* This is the net value at the rated load.

◆ Single-phase, 100 VAC

Model SGD7S-		R70F	R90F	2R1F	2R8F
Maximum Applicable Motor Capacity [kW]		0.05	0.1	0.2	0.4
Continuous Output Current [Arms]		0.66	0.91	2.1	2.8
Instantaneous Maximum Output Current [Arms]		2.1	3.2	6.5	9.3
Main Circuit	Power Supply	100 VAC to 120 VAC, -15% to +10%, 50 Hz/60 Hz			
	Input Current [Arms]*	1.5	2.5	5	10
Control	Power Supply	100 VAC to 120 VAC, -15% to +10%, 50 Hz/60 Hz			
	Input Current [Arms]*	0.38	0.38	0.38	0.38
Power Supply Capacity [kVA]*		0.2	0.3	0.6	1.4
Power Loss*	Main Circuit Power Loss [W]	5.3	7.8	14.2	26.2
	Control Circuit Power Loss [W]	12	12	12	12
	Total Power Loss [W]	17.3	19.8	26.2	38.2
Regenerative Resistor	Minimum Allowable External Resistance [Ω]	40	40	40	40
Overvoltage Category		III			

* This is the net value at the rated load.

SERVOPACK Overload Protection Characteristics

The overload detection level is set for hot start conditions with a SERVOPACK surrounding air temperature of 55°C.

An overload alarm (A.710 or A.720) will occur if overload operation that exceeds the overload protection characteristics shown in the following diagram (i.e., operation on the right side of the applicable line) is performed.

The actual overload detection level will be the detection level of the connected SERVOPACK or Servomotor that has the lower overload protection characteristics.

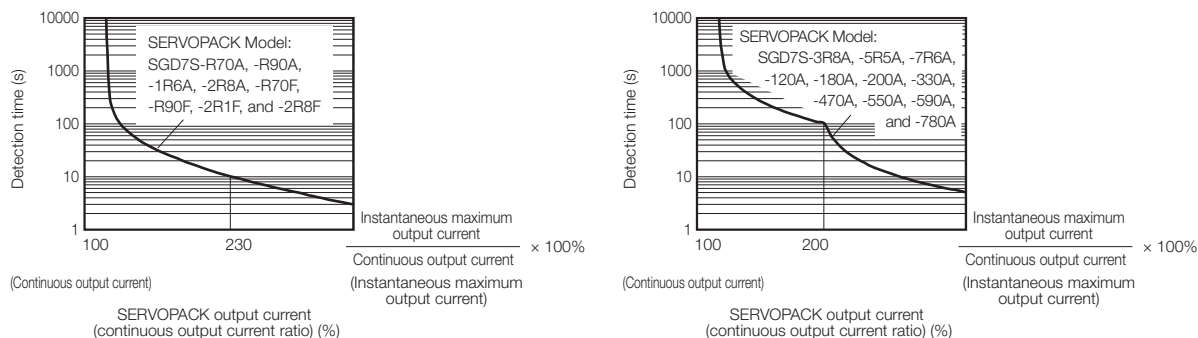

In most cases, that will be the overload protection characteristics of the Servomotor.



Note: The above overload protection characteristics do not mean that you can perform continuous duty operation with an output of 100% or higher.

For a Yaskawa-specified combination of SERVOPACK and Servomotor, maintain the effective torque (or effective force) within the continuous duty zone of the torque-motor speed characteristic (or force-motor speed characteristics) of the Servomotor.

Specifications

Item		Specification								
Control Method		IGBT-based PWM control, sine wave current drive								
Feedback	With Rotary Servomotor	Serial encoder: 17 bits (absolute encoder) 20 bits or 24 bits (incremental encoder/absolute encoder) 22 bits (absolute encoder)								
	With Linear Servomotor	<ul style="list-style-type: none"> Absolute linear encoder (The signal resolution depends on the absolute linear encoder.) Incremental linear encoder (The signal resolution depends on the incremental linear encoder or Serial Converter Unit.) 								
Surrounding Air Temperature*1		-5°C to 55°C With derating, usage is possible between 55°C and 60°C. Refer to the following section for derating specifications.  <i>Derating Specifications (page 333)</i>								
Storage Temperature		-20°C to 85°C								
Surrounding Air Humidity		95% relative humidity max. (with no freezing or condensation)								
Storage Humidity		95% relative humidity max. (with no freezing or condensation)								
Vibration Resistance		4.9 m/s ²								
Shock Resistance		19.6 m/s ²								
Environmental Conditions	Degree of Protection	<table border="1"> <thead> <tr> <th>Class</th> <th>SERVOPACK Model: SGD7S-</th> </tr> </thead> <tbody> <tr> <td>IP20</td> <td>R70A, R90A, 1R6A, 2R8A, 3R8A, 5R5A, 7R6A, 120A, R70F, R90F, 2R1F, 2R8F</td> </tr> <tr> <td>IP10</td> <td>120A00A008, 180A, 200A, 330A, 470A, 550A, 590A, 780A</td> </tr> </tbody> </table>	Class	SERVOPACK Model: SGD7S-	IP20	R70A, R90A, 1R6A, 2R8A, 3R8A, 5R5A, 7R6A, 120A, R70F, R90F, 2R1F, 2R8F	IP10	120A00A008, 180A, 200A, 330A, 470A, 550A, 590A, 780A		
		Class	SERVOPACK Model: SGD7S-							
		IP20	R70A, R90A, 1R6A, 2R8A, 3R8A, 5R5A, 7R6A, 120A, R70F, R90F, 2R1F, 2R8F							
	IP10	120A00A008, 180A, 200A, 330A, 470A, 550A, 590A, 780A								
	Pollution Degree	2 <ul style="list-style-type: none"> Must be no corrosive or flammable gases. Must be no exposure to water, oil, or chemicals. Must be no dust, salts, or iron dust. 								
	Altitude*1	1,000 m or less. With derating, usage is possible between 1,000 m and 2,000 m. Refer to the following section for derating specifications.  <i>Derating Specifications (page 333)</i>								
Others	Do not use the SERVOPACK in the following locations: Locations subject to static electricity noise, strong electromagnetic/magnetic fields, or radioactivity									
Applicable Standards		UL 61800-5-1 (E147823), CSA C22.2 No.274, EN ISO13849-1: 2015, EN 55011 group 1 class A, EN 61000-6-2, EN 61000-6-4, EN 61800-3 (Category C2, Second environment), EN 50178, EN 61800-5-1, IEC 60204-1, IEC 61508 series, IEC 62061, IEC 61800-5-2, and IEC 61326-3-1								
Mounting	<table border="1"> <thead> <tr> <th>Mounting</th> <th>SERVOPACK Model: SGD7S-</th> </tr> </thead> <tbody> <tr> <td>Base-mounted</td> <td>All Models</td> </tr> <tr> <td>Rack-mounted</td> <td>R70A, R90A, 1R6A, 2R8A, 3R8A, 5R5A, 7R6A, 120A, 180A, 200A, 330A, R70F, R90F, 2R1F, 2R8F</td> </tr> <tr> <td>Duct-ventilated</td> <td>470A, 550A, 590A, 780A</td> </tr> </tbody> </table>		Mounting	SERVOPACK Model: SGD7S-	Base-mounted	All Models	Rack-mounted	R70A, R90A, 1R6A, 2R8A, 3R8A, 5R5A, 7R6A, 120A, 180A, 200A, 330A, R70F, R90F, 2R1F, 2R8F	Duct-ventilated	470A, 550A, 590A, 780A
	Mounting	SERVOPACK Model: SGD7S-								
	Base-mounted	All Models								
	Rack-mounted	R70A, R90A, 1R6A, 2R8A, 3R8A, 5R5A, 7R6A, 120A, 180A, 200A, 330A, R70F, R90F, 2R1F, 2R8F								
Duct-ventilated	470A, 550A, 590A, 780A									
Speed Control Range	1:5000 (At the rated torque, the lower limit of the speed control range must not cause the Servomotor to stop.)									
Coefficient of Speed Fluctuation*2	±0.01% of rated speed max. (for a load fluctuation of 0% to 100%)									
	0% of rated speed max. (for a voltage fluctuation of ±10%) ±0.1% of rated speed max. (for a temperature fluctuation of 25°C ±25°C)									
Torque Control Precision (Repeatability)	±1%									
Soft Start Time Setting	0 s to 10 s (Can be set separately for acceleration and deceleration.)									

Continued on next page.

Continued from previous page.

Item		Specification	
I/O Signals	Encoder Divided Pulse Output	Phase A, phase B, phase C: Line-driver output Number of divided output pulses: Any setting is allowed.	
	Overheat Protection Input	Number of input points: 1 Input voltage range: 0 V to +5 V	
	Sequence Input Signals	Fixed Input	Allowable voltage range: 5 VDC ±5% Number of input points: 1 Absolute Data Request (SEN)
		Input Signals That Can Be Allocated	Allowable voltage range: 24 VDC ±20% Number of input points: 7
			Input method: Sink inputs or source inputs Input Signals
			<ul style="list-style-type: none"> • /S-ON (Servo ON) signal • /P-CON (Proportional Control) Signal • P-OT (Forward Drive Prohibit) and N-OT (Reverse Drive Prohibit) signals • /ALM-RST (Alarm Reset) signal • /P-CL (Forward External Torque Limit) and /N-CL (Reverse External Torque Limit) signals • /SPD-D (Motor Direction) signal • /SPD-A and /SPD-B (Internal Set Speed Selection) signals • /C-SEL (Control Selection) signal • /ZCLAMP (Zero Clamping) signal • /INHIBIT (Reference Pulse Inhibit) signal • /G-SEL (Gain Selection) signal • /P-DET (Polarity Detection) signal • SEN (Absolute Data Request) signal • /PSEL (Reference Pulse Input Multiplication Switch) Signal • FSTP (Forced Stop Input) signal A signal can be allocated and the positive and negative logic can be changed.
Sequence Output Signals	Fixed Output	Allowable voltage range: 5 VDC to 30 VDC Number of output points: 1 Output signal: Servo Alarm (ALM)	
	Output Signals That Can Be Allocated	Allowable voltage range: 5 VDC to 30 VDC Number of output points: 6 (A photocoupler output (isolated) is used for three of the outputs.) (An open-collector output (non-isolated) is used for the other three outputs.) Output Signals	
Communications	RS-422A Communications (CN3)	Interfaces	Digital Operator (JUSP-OP05A-1-E) and personal computer (with SigmaWin+)
		1:N Communications	Up to N = 15 stations possible for RS-422A port
		Axis Address Setting	Set with parameters.
	USB Communications (CN7)	Interface	Personal computer (with SigmaWin+)
Communications Standard		Conforms to USB2.0 standard (12 Mbps).	
Displays/Indicators		CHARGE indicator and five-digit seven-segment display	

Continued on next page.

SERVOPACKs

Σ-7S Single-axis Analog Voltage/Pulse Train Reference SERVOPACKs

Continued from previous page.

Item		Specification			
Panel Operator		Four push switches			
Analog Monitor (CN5)		Number of points: 2 Output voltage range: ±10 VDC (effective linearity range: ±8 V) Resolution: 16 bits Accuracy: ±20 mV (Typ) Maximum output current: ±10 mA Settling time (±1%): 1.2 ms (Typ)			
Dynamic Brake (DB)		Activated when a servo alarm or overtravel (OT) occurs, or when the power supply to the main circuit or servo is OFF.			
Regenerative Processing		Built-in (An external resistor must be connected to the SGD7S-470A to -780A.)  <i>Built-In Regenerative Resistor (page 472)</i>			
Overtravel (OT) Prevention		Stopping with dynamic brake, deceleration to a stop, or coasting to a stop for the P-OT (Forward Drive Prohibit) or N-OT (Reverse Drive Prohibit) signal			
Protective Functions		Overcurrent, overvoltage, low voltage, overload, regeneration error, etc.			
Utility Functions		Gain adjustment, alarm history, jogging, origin search, etc.			
Safety Functions	Inputs	/HWBB1 and /HWBB2: Base block signals for Power Modules			
	Output	EDM1: Monitors the status of built-in safety circuit (fixed output).			
	Applicable Standards*3	ISO13849-1 PLe (Category 3) and IEC61508 SIL3			
Option Module		Fully-Closed Modules and Safety Modules Note: You cannot use a Fully-Closed Module and a Safety Module together.			
Controls	Speed Control	Soft Start Time Setting	0 s to 10 s (Can be set separately for acceleration and deceleration.)		
		Input Signal	Reference Voltage	<ul style="list-style-type: none"> • Maximum input voltage: ±12 V (forward motor rotation for positive reference). • 6 VDC at rated speed (default setting). Input gain setting can be changed. 	
			Input Impedance	Approx. 14 kΩ	
			Circuit Time Constant	30 μs	
		Internal Set Speed Control	Rotation Direction Selection	With Proportional Control signal	
	Speed Selection		With Forward/Reverse External Torque Limit signals (speed 1 to 3 selection). Servomotor stops or another control method is used when both signals are OFF.		
	Position Control	Feedforward Compensation		0% to 100%	
		Output Signal Positioning Completed Width Setting		0 to 1,073,741,824 reference units	
		Input Signals	Reference pulses	Reference Pulse Form	One of the following is selected: Sign + pulse train, CW + CCW pulse trains, and two-phase pulse trains with 90° phase differential
				Input Form	Line driver or open collector
			Maximum Input Frequency	• Line Driver Sign + pulse train or CW + CCW pulse trains: 4 Mpps Two-phase pulse trains with 90° phase differential: 1 Mpps	
				• Open Collector Sign + pulse train or CW + CCW pulse trains: 200 kpps Two-phase pulse trains with 90° phase differential: 200 kpps	
		Input Multiplication Switching	1 to 100 times		
		Clear Signal		Position deviation clear Line driver or open collector	
	Torque Control	Input Signal	Reference Voltage	<ul style="list-style-type: none"> • Maximum input voltage: ±12 V (forward torque output for positive reference). • 3 VDC at rated torque (default setting). Input gain setting can be changed. 	
			Input Impedance	Approx. 14 kΩ	
			Circuit Time Constant	16 μs	

- *1. If you combine a Σ-7-Series SERVOPACK with a Σ-V-Series Option Module, the following Σ-V-Series SERVO-PACKs specifications must be used: a surrounding air temperature of 0°C to 55°C and an altitude of 1,000 m max. Also, the applicable range cannot be increased by derating.
- *2. The coefficient of speed fluctuation for load fluctuation is defined as follows:

$$\text{Coefficient of speed fluctuation} = \frac{\text{No-load motor speed} - \text{Total-load motor speed}}{\text{Rated motor speed}} \times 100\%$$

- *3. Always perform risk assessment for the system and confirm that the safety requirements are met.

Derating Specifications

If you use the SERVOPACK at a surrounding air temperature of 55°C to 60°C or at an altitude of 1,000 m to 2,000 m, you must apply the derating rates given in the following graphs.

◆ SGD7S-R70A, -R90A, -1R6A, -2R8A, -R70F, -R90F, -2R1F, and -2R8F

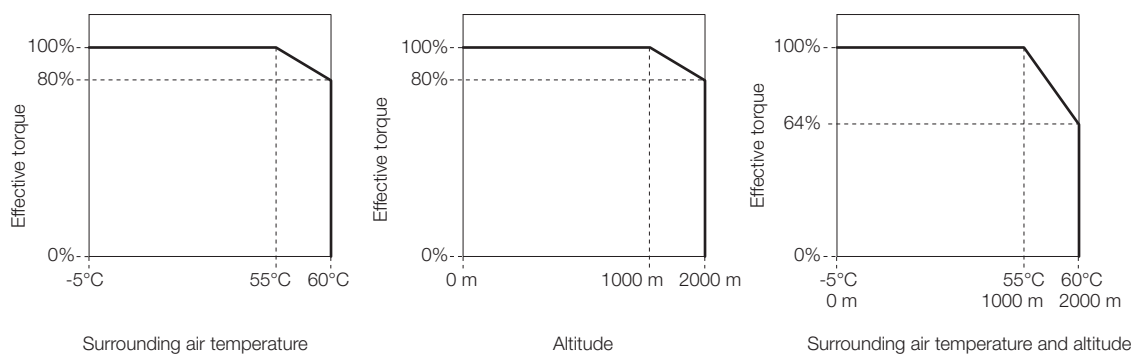

◆ SGD7S-3R8A, -5R5A, -7R6A, -120A, -180A, -200A, -330A, -470A, -550A, -590A, and -780A

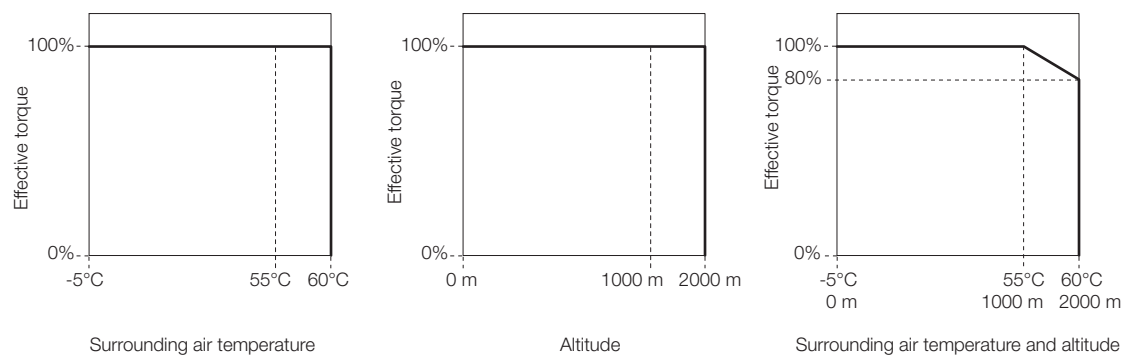

Selecting Cables

◆ System Configurations

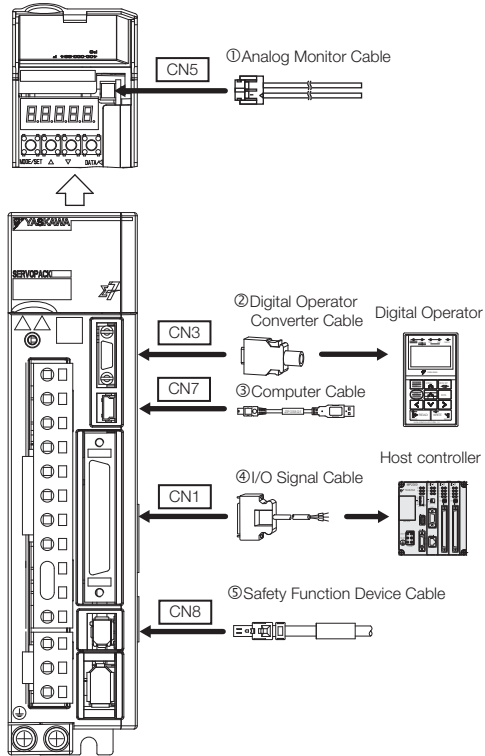

◆ Selection Table



1. Use the cable specified by Yaskawa for the Computer Cable. Operation may not be dependable with any other cable.
2. Use the cable specified by Yaskawa for the MECHATROLINK Communications Cables. Operation may not be dependable due to low noise resistance with any other cable.

Note: Refer to the following manual for the following information.

- Cable dimensional drawings and cable connection specifications
- Order numbers and specifications of individual connectors for cables

📖 *Σ-7-Series AC Servo Drive Peripheral Device Selection Manual (Manual No.: SIEP S800001 32)*

Code	Name	Length (L)	Order Number	Appearance	
①	Analog Monitor Cable	1 m	JZSP-CA01-E		
②	Digital Operator Converter Cable	0.3 m	JZSP-CVS05-A3-E*1		
③	Computer Cable	2.5 m	JZSP-CVS06-02-E		
④	I/O Signal Cables	Soldered Connector Kit	JZSP-CSI9-1-E		
		Connector-Terminal Block Converter Unit (with cable)	0.5 m	JUSP-TA50PG-E	
			1 m	JUSP-TA50PG-1-E	
			2 m	JUSP-TA50PG-2-E	
		Cable with Loose Wires at One End (loose wires on peripheral device end)	1 m	JZSP-CSI01-1-E	
			2 m	JZSP-CSI01-2-E	
3 m	JZSP-CSI01-3-E				
⑤	Safety Function Device Cables	Cables with Connectors*2	1 m	JZSP-CVH03-01-E	
			3 m	JZSP-CVH03-03-E	
		Connector Kit*3	Contact Tyco Electronics Japan G.K. Product name: Industrial Mini I/O D-shape Type 1 Plug Connector Kit Model number: 2013595-1		

*1. This Converter Cable is required to use the Σ-III-series Digital Operator (JUSP-OP05A) for Σ-7-series SERVOPACKs.

*2. When using safety functions, connect this Cable to the safety function devices.
When not using safety functions, connect the enclosed Safety Jumper Connector (JZSP-CVH05-E) to the SERVOPACK.

*3. Use the Connector Kit when you make cables yourself.

Model Designations

SGD7S - R70 A 10 A 001 000 B

Σ-7 Series
Σ-7S SERVOPACKs

1st+2nd+3rd digits

4th digit

5th+6th digits

7th digit

8th+9th+10th digits

11th+12th+13th digits

14th digit

1st+2nd+3rd digits Maximum Applicable Motor Capacity

Voltage	Code	Specification
Three-phase, 200 VAC	R70*1	0.05 kW
	R90*1	0.1 kW
	1R6*1	0.2 kW
	2R8*1	0.4 kW
	3R8	0.5 kW
	5R5*1	0.75 kW
	7R6	1.0 kW
	120*2	1.5 kW
	180	2.0 kW
	200*3	3.0 kW
	330	5.0 kW
	470	6.0 kW
	550	7.5 kW
590	11 kW	
780	15 kW	
Single-phase, 100 VAC	R70	0.05 kW
	R90	0.1 kW
	2R1	0.2 kW
	2R8	0.4 kW

4th digit Voltage

Code	Specification
A	200 VAC
F	100 VAC

5th+6th digits Interface*4

Code	Specification
10	MECHATROLINK-II communications reference

7th digit Design Revision Order

A

8th+9th+10th digits Hardware Options Specification

Code	Specification	Applicable Models
None	Without options	All models
000		
001	Rack-mounted	SGD7S-R70A to -330A SGD7S-R70F to -2R8F
	Duct-ventilated	SGD7S-470A to -780A
002	Varnished	All models
008	Single-phase, 200-VAC power supply input	SGD7S-120A
020*5	No dynamic brake	SGD7S-R70A to -2R8A SGD7S-R70F to -2R8F
	External dynamic brake resistor	SGD7S-3R8A to -780A

11th+12th+13th digits FT/EX Specification

Code	Specification
None	None
000	

14th digit BTO Specification*6 (Available in Japan only)

Code	Specification
None	None
B	BTO Specification

*1. You can use these models with either a single-phase or three-phase power supply input.

*2. A model with a single-phase, 200-VAC power supply input is available as a hardware option (model: SGD7S-120A10A008).

*3. The rated output is 2.4 kW if you combine the SGM7G-30A with the SGD7S-200A.

*4. The same SERVOPACKs are used for both Rotary Servomotors and Linear Servomotors.

*5. Refer to the following manual for details.

📖 *Σ-7-Series AC Servo Drive Σ-7S/Σ-7W SERVOPACK with Hardware Option Specifications Dynamic Brake Product Manual* (Manual No.: SIEP S800001 73)

*6. The BTO specification indicates if the SERVOPACK is customized by using the MechatroCloud BTO service.

You need a BTO number to order SERVOPACKs with customized specifications.

Refer to page M-15 for the details on the BTO service.

Ratings and Specifications

Ratings

◆ Three-phase, 200 VAC

Model SGD7S-		R70A	R90A	1R6A	2R8A	3R8A	5R5A	7R6A	120A	180A	200A	330A	
Maximum Applicable Motor Capacity [kW]		0.05	0.1	0.2	0.4	0.5	0.75	1.0	1.5	2.0	3.0	5.0	
Continuous Output Current [Arms]		0.66	0.91	1.6	2.8	3.8	5.5	7.6	11.6	18.5	19.6	32.9	
Instantaneous Maximum Output Current [Arms]		2.1	3.2	5.9	9.3	11	16.9	17	28	42	56	84.0	
Main Circuit	Power Supply	200 VAC to 240 VAC, -15% to +10%, 50 Hz/60 Hz											
	Input Current [Arms]*	0.4	0.8	1.3	2.5	3.0	4.1	5.7	7.3	10	15	25	
Control	Power Supply	200 VAC to 240 VAC, -15% to +10%, 50 Hz/60 Hz											
	Input Current [Arms]*	0.2	0.2	0.2	0.2	0.2	0.2	0.2	0.2	0.25	0.25	0.3	
Power Supply Capacity [kVA]*		0.2	0.3	0.5	1.0	1.3	1.6	2.3	3.2	4.0	5.9	7.5	
Power Loss*	Main Circuit Power Loss [W]	5.0	7.0	11.9	22.5	28.5	38.9	49.2	72.6	104.2	114.2	226.6	
	Control Circuit Power Loss [W]	12	12	12	12	14	14	14	15	16	16	19	
	Built-in Regenerative Resistor Power Loss [W]	–	–	–	–	8	8	8	10	16	16	36	
	Total Power Loss [W]	17.0	19.0	23.9	34.5	50.5	60.9	71.2	97.6	136.2	146.2	281.6	
Regenerative Resistor	Built-In Regenerative Resistor	Resistance [Ω]	–	–	–	–	40	40	40	20	12	12	8
		Capacity [W]	–	–	–	–	40	40	40	60	60	60	180
	Minimum Allowable External Resistance [Ω]		40	40	40	40	40	40	40	20	12	12	8
Overvoltage Category		III											

* This is the net value at the rated load.

Model SGD7S-		470A	550A	590A	780A	
Maximum Applicable Motor Capacity [kW]		6.0	7.5	11	15	
Continuous Output Current [Arms]		46.9	54.7	58.6	78.0	
Instantaneous Maximum Output Current [Arms]		110	130	140	170	
Main Circuit	Power Supply	200 VAC to 240 VAC, -15% to +10%, 50 Hz/60 Hz				
	Input Current [Arms] ^{*1}	29	37	54	73	
Control	Power Supply	200 VAC to 240 VAC, -15% to +10%, 50 Hz/60 Hz				
	Input Current [Arms] ^{*1}	0.3	0.3	0.4	0.4	
Power Supply Capacity [kVA] ^{*1}		10.7	14.6	21.7	29.6	
Power Loss ^{*1}	Main Circuit Power Loss [W]	271.7	326.9	365.3	501.4	
	Control Circuit Power Loss [W]	21	21	28	28	
	External Regenerative Resistor Unit Power Loss [W]	180 ^{*2}	180 ^{*3}	350 ^{*3}	350 ^{*3}	
	Total Power Loss [W]	292.7	347.9	393.3	529.4	
External Regenerative Resistor Unit	External Regenerative Resistor Unit	Resistance [Ω]	6.25 ^{*2}	3.13 ^{*3}	3.13 ^{*3}	3.13 ^{*3}
		Capacity [W]	880 ^{*2}	1760 ^{*3}	1760 ^{*3}	1760 ^{*3}
	Minimum Allowable External Resistance [Ω]		5.8	2.9	2.9	2.9
Overvoltage Category		III				

*1. This is the net value at the rated load.

*2. This value is for the optional JUSP-RA04-E Regenerative Resistor Unit.

*3. This value is for the optional JUSP-RA05-E Regenerative Resistor Unit.

SERVOPACKs

Σ-7S Single-axis MECHATROLINK-II Communications Reference SERVOPACKs

◆ Single-phase, 200 VAC

Model SGD7S-		R70A	R90A	1R6A	2R8A	5R5A	120A	
Maximum Applicable Motor Capacity [kW]		0.05	0.1	0.2	0.4	0.75	1.5	
Continuous Output Current [Arms]		0.66	0.91	1.6	2.8	5.5	11.6	
Instantaneous Maximum Output Current [Arms]		2.1	3.2	5.9	9.3	16.9	28	
Main Circuit	Power Supply	200 VAC to 240 VAC, -15% to +10%, 50 Hz/60 Hz						
	Input Current [Arms]*	0.8	1.6	2.4	5.0	8.7	16	
Control	Power Supply	200 VAC to 240 VAC, -15% to +10%, 50 Hz/60 Hz						
	Input Current [Arms]*	0.2	0.2	0.2	0.2	0.2	0.25	
Power Supply Capacity [kVA]*		0.2	0.3	0.6	1.2	1.9	4.0	
Power Loss*	Main Circuit Power Loss [W]	5.0	7.1	12.1	23.7	39.2	71.8	
	Control Circuit Power Loss [W]	12	12	12	12	14	16	
	Built-in Regenerative Resistor Power Loss [W]	-	-	-	-	8	16	
	Total Power Loss [W]	17.0	19.1	24.1	35.7	61.2	103.8	
Regenerative Resistor	Built-In Regenerative Resistor	Resistance [Ω]	-	-	-	-	40	12
		Capacity [W]	-	-	-	-	40	60
	Minimum Allowable External Resistance [Ω]		40	40	40	40	40	12
Overvoltage Category		III						

* This is the net value at the rated load.

◆ 270 VDC

Model SGD7S-		R70A	R90A	1R6A	2R8A	3R8A	5R5A	7R6A	120A
Maximum Applicable Motor Capacity [kW]		0.05	0.1	0.2	0.4	0.5	0.75	1.0	1.5
Continuous Output Current [Arms]		0.66	0.91	1.6	2.8	3.8	5.5	7.6	11.6
Instantaneous Maximum Output Current [Arms]		2.1	3.2	5.9	9.3	11.0	16.9	17.0	28.0
Main Circuit	Power Supply	270 VDC to 324 VDC, -15% to +10%							
	Input Current [Arms]* ¹	0.5	1.0	1.5	3.0	3.8	4.9	6.9	11
Control	Power Supply	270 VDC to 324 VDC, -15% to +10%							
	Input Current [Arms]* ¹	0.2	0.2	0.2	0.2	0.2	0.2	0.2	0.2 ^{*2}
Power Supply Capacity [kVA]* ¹		0.2	0.3	0.6	1	1.4	1.6	2.3	3.2
Power Loss* ¹	Main Circuit Power Loss [W]	4.4	5.9	9.8	17.5	23.0	30.7	38.7	55.8
	Control Circuit Power Loss [W]	12	12	12	12	14	14	14	15
	Total Power Loss [W]	16.4	17.9	21.8	29.5	37.0	44.7	52.7	70.8
Overvoltage Category		III							

*1. This is the net value at the rated load.

*2. The value is 0.25 Arms for the SGD7S-120A00A008.

Model SGD7S-		180A	200A	330A	470A	550A	590A	780A
Maximum Applicable Motor Capacity [kW]		2.0	3.0	5.0	6.0	7.5	11.0	15.0
Continuous Output Current [Arms]		18.5	19.6	32.9	46.9	54.7	58.6	78.0
Instantaneous Maximum Output Current [Arms]		42.0	56.0	84.0	110	130	140	170
Main Circuit	Power Supply	270 VDC to 324 VDC, -15% to +10%						
	Input Current [Arms]*	14	20	34	36	48	68	92
Control	Power Supply	270 VDC to 324 VDC, -15% to +10%						
	Input Current [Arms]*	0.25	0.25	0.3	0.3	0.3	0.4	0.4
Power Supply Capacity [kVA]*		4.0	5.9	7.5	10.7	14.6	21.7	29.6
Power Loss*	Main Circuit Power Loss [W]	82.7	83.5	146.2	211.6	255.3	243.6	343.4
	Control Circuit Power Loss [W]	16	16	19	21	21	28	28
	Total Power Loss [W]	98.7	99.5	165.2	232.6	276.3	271.6	371.4
Overvoltage Category		III						

* This is the net value at the rated load.

◆ Single-phase, 100 VAC

Model SGD7S-		R70F	R90F	2R1F	2R8F
Maximum Applicable Motor Capacity [kW]		0.05	0.1	0.2	0.4
Continuous Output Current [Arms]		0.66	0.91	2.1	2.8
Instantaneous Maximum Output Current [Arms]		2.1	3.2	6.5	9.3
Main Circuit	Power Supply	100 VAC to 120 VAC, -15% to +10%, 50 Hz/60 Hz			
	Input Current [Arms]*	1.5	2.5	5	10
Control	Power Supply	100 VAC to 120 VAC, -15% to +10%, 50 Hz/60 Hz			
	Input Current [Arms]*	0.38	0.38	0.38	0.38
Power Supply Capacity [kVA]*		0.2	0.3	0.6	1.4
Power Loss*	Main Circuit Power Loss [W]	5.3	7.8	14.2	26.2
	Control Circuit Power Loss [W]	12	12	12	12
	Total Power Loss [W]	17.3	19.8	26.2	38.2
Regenerative Resistor	Minimum Allowable External Resistance [Ω]	40	40	40	40
Overvoltage Category		III			

* This is the net value at the rated load.

SERVOPACK Overload Protection Characteristics

The overload detection level is set for hot start conditions with a SERVOPACK surrounding air temperature of 55°C.

An overload alarm (A.710 or A.720) will occur if overload operation that exceeds the overload protection characteristics shown in the following diagram (i.e., operation on the right side of the applicable line) is performed.

The actual overload detection level will be the detection level of the connected SERVOPACK or Servomotor that has the lower overload protection characteristics.

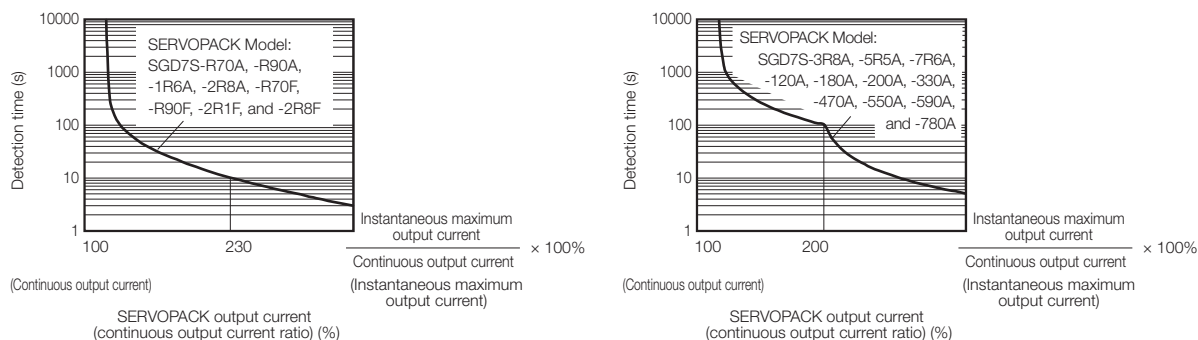

In most cases, that will be the overload protection characteristics of the Servomotor.



Note: The above overload protection characteristics do not mean that you can perform continuous duty operation with an output of 100% or higher.

For a Yaskawa-specified combination of SERVOPACK and Servomotor, maintain the effective torque (or effective force) within the continuous duty zone of the torque-motor speed characteristic (or force-motor speed characteristics) of the Servomotor.

Specifications

Item		Specification								
Control Method		IGBT-based PWM control, sine wave current drive								
Feedback	With Rotary Servomotor	Serial encoder: 17 bits (absolute encoder) 20 bits or 24 bits (incremental encoder/absolute encoder) 22 bits (absolute encoder)								
	With Linear Servomotor	<ul style="list-style-type: none"> Absolute linear encoder (The signal resolution depends on the absolute linear encoder.) Incremental linear encoder (The signal resolution depends on the incremental linear encoder or Serial Converter Unit.) 								
Environmental Conditions	Surrounding Air Temperature* ¹	-5°C to 55°C With derating, usage is possible between 55°C and 60°C. Refer to the following section for derating specifications.  <i>Derating Specifications (page 343)</i>								
	Storage Temperature	-20°C to 85°C								
	Surrounding Air Humidity	95% relative humidity max. (with no freezing or condensation)								
	Storage Humidity	95% relative humidity max. (with no freezing or condensation)								
	Vibration Resistance	4.9 m/s ²								
	Shock Resistance	19.6 m/s ²								
	Degree of Protection	<table border="1"> <thead> <tr> <th>Class</th> <th>SERVOPACK Model: SGD7S-</th> </tr> </thead> <tbody> <tr> <td>IP20</td> <td>R70A, R90A, 1R6A, 2R8A, 3R8A, 5R5A, 7R6A, 120A, R70F, R90F, 2R1F, 2R8F</td> </tr> <tr> <td>IP10</td> <td>120A10A008, 180A, 200A, 330A, 470A, 550A, 590A, 780A</td> </tr> </tbody> </table>	Class	SERVOPACK Model: SGD7S-	IP20	R70A, R90A, 1R6A, 2R8A, 3R8A, 5R5A, 7R6A, 120A, R70F, R90F, 2R1F, 2R8F	IP10	120A10A008, 180A, 200A, 330A, 470A, 550A, 590A, 780A		
	Class	SERVOPACK Model: SGD7S-								
	IP20	R70A, R90A, 1R6A, 2R8A, 3R8A, 5R5A, 7R6A, 120A, R70F, R90F, 2R1F, 2R8F								
	IP10	120A10A008, 180A, 200A, 330A, 470A, 550A, 590A, 780A								
Pollution Degree	2 <ul style="list-style-type: none"> Must be no corrosive or flammable gases. Must be no exposure to water, oil, or chemicals. Must be no dust, salts, or iron dust. 									
Altitude* ¹	1,000 m or less. With derating, usage is possible between 1,000 m and 2,000 m. Refer to the following section for derating specifications.  <i>Derating Specifications (page 343)</i>									
Others	Do not use the SERVOPACK in the following locations: Locations subject to static electricity noise, strong electromagnetic/magnetic fields, or radioactivity									
Applicable Standards		UL 61800-5-1 (E147823), CSA C22.2 No.274, EN ISO13849-1: 2015, EN 55011 group 1 class A, EN 61000-6-2, EN 61000-6-4, EN 61800-3 (Category C2, Second environment), EN 50178, EN 61800-5-1, IEC 60204-1, IEC 61508 series, IEC 62061, IEC 61800-5-2, and IEC 61326-3-1								
Mounting		<table border="1"> <thead> <tr> <th>Mounting</th> <th>SERVOPACK Model: SGD7S-</th> </tr> </thead> <tbody> <tr> <td>Base-mounted</td> <td>All Models</td> </tr> <tr> <td>Rack-mounted</td> <td>R70A, R90A, 1R6A, 2R8A, 3R8A, 5R5A, 7R6A, 120A, 180A, 200A, 330A, R70F, R90F, 2R1F, 2R8F</td> </tr> <tr> <td>Duct-ventilated</td> <td>470A, 550A, 590A, 780A</td> </tr> </tbody> </table>	Mounting	SERVOPACK Model: SGD7S-	Base-mounted	All Models	Rack-mounted	R70A, R90A, 1R6A, 2R8A, 3R8A, 5R5A, 7R6A, 120A, 180A, 200A, 330A, R70F, R90F, 2R1F, 2R8F	Duct-ventilated	470A, 550A, 590A, 780A
Mounting	SERVOPACK Model: SGD7S-									
Base-mounted	All Models									
Rack-mounted	R70A, R90A, 1R6A, 2R8A, 3R8A, 5R5A, 7R6A, 120A, 180A, 200A, 330A, R70F, R90F, 2R1F, 2R8F									
Duct-ventilated	470A, 550A, 590A, 780A									
Performance	Speed Control Range	1:5000 (At the rated torque, the lower limit of the speed control range must not cause the Servomotor to stop.)								
	Coefficient of Speed Fluctuation* ²	±0.01% of rated speed max. (for a load fluctuation of 0% to 100%)								
		0% of rated speed max. (for a voltage fluctuation of ±10%)								
		±0.1% of rated speed max. (for a temperature fluctuation of 25°C ±25°C)								
Torque Control Precision (Repeatability)	±1%									
Soft Start Time Setting	0 s to 10 s (Can be set separately for acceleration and deceleration.)									

Continued on next page.

Continued from previous page.

Item		Specification	
I/O Signals	Encoder Divided Pulse Output	Phase A, phase B, phase C: Line-driver output Number of divided output pulses: Any setting is allowed.	
	Overheat Protection Input	Number of input points: 1 Input voltage range: 0 V to +5 V	
	Sequence Input Signals	Input Signals That Can Be Allocated	Allowable voltage range: 24 VDC ±20% Number of input points: 7 Input method: Sink inputs or source inputs Input Signals <ul style="list-style-type: none"> • P-OT (Forward Drive Prohibit) and N-OT (Reverse Drive Prohibit) signals • /P-CL (Forward External Torque Limit) and /N-CL (Reverse External Torque Limit) signals • /DEC (Origin Return Deceleration Switch) signal • /EXT1 to /EXT3 (External Latch Input 1 to 3) signals • FSTP (Forced Stop Input) signal A signal can be allocated and the positive and negative logic can be changed.
		Fixed Output	Allowable voltage range: 5 VDC to 30 VDC Number of output points: 1 Output signal: Servo Alarm (ALM)
	Sequence Output Signals	Output Signals That Can Be Allocated	Allowable voltage range: 5 VDC to 30 VDC Number of output points: 3 (A photocoupler output (isolated) is used.) Output Signals <ul style="list-style-type: none"> • /COIN (Positioning Completion) signal • /V-CMP (Speed Coincidence Detection) signal • /TGON (Rotation Detection) signal • /S-RDY (Servo Ready) signal • /CLT (Torque Limit Detection) signal • /VLT (Speed Limit Detection) signal • /BK (Brake) signal • /WARN (Warning) signal • /NEAR (Near) signal A signal can be allocated and the positive and negative logic can be changed.
Communications	RS-422A Communications (CN3)	Interfaces	Digital Operator (JUSP-OP05A-1-E) and personal computer (with SigmaWin+)
		1:N Communications	Up to N = 15 stations possible for RS-422A port
		Axis Address Setting	41 to 5F hex (maximum number of slaves: 30) Selected with the combination of a rotary switch (S2) and DIP switch (S3).
	USB Communications (CN7)	Interface	Personal computer (with SigmaWin+)
Communications Standard		Conforms to USB2.0 standard (12 Mbps).	
Displays/Indicators		CHARGE, PWR, and COM indicators, and one-digit seven-segment display	
MECHATROLINK-II Communications	Communications Protocol	MECHATROLINK-II	
	Station Address Settings	41 to 5F hex (maximum number of slaves: 30) Selected with the combination of a rotary switch (S2) and DIP switch (S3).	
	Baud Rate	10 Mbps, 4 Mbps A DIP switch (S3) is used to select the baud rate.	
	Transmission Cycle	250 μs or 0.5 ms to 4.0 ms (multiples of 0.5 ms)	
	Number of Transmission Bytes	17 or 32 bytes/station A DIP switch (S3) is used to select the number of transmission bytes.	
Reference Method	Performance	Position, speed, or torque control with MECHATROLINK-II communications	
	Reference Input	MECHATROLINK-I or MECHATROLINK-II commands (sequence, motion, data setting, data access, monitoring, adjustment, etc.)	
MECHATROLINK-II Communications Setting Switches		Rotary switch (S2) positions: 16 Number of DIP switch (S3) pins: 4	

Continued on next page.

SERVOPACKs

Σ-7S Single-axis MECHATROLINK-II Communications Reference SERVOPACKs

Continued from previous page.

Item		Specification
Analog Monitor (CN5)		Number of points: 2 Output voltage range: ±10 VDC (effective linearity range: ±8 V) Resolution: 16 bits Accuracy: ±20 mV (Typ) Maximum output current: ±10 mA Settling time (±1%): 1.2 ms (Typ)
Dynamic Brake (DB)		Activated when a servo alarm or overtravel (OT) occurs, or when the power supply to the main circuit or servo is OFF.
Regenerative Processing		Built-in (An external resistor must be connected to the SGD7S-470A to -780A.)  Built-In Regenerative Resistor (page 472)
Overtravel (OT) Prevention		Stopping with dynamic brake, deceleration to a stop, or coasting to a stop for the P-OT (Forward Drive Prohibit) or N-OT (Reverse Drive Prohibit) signal
Protective Functions		Overcurrent, overvoltage, low voltage, overload, regeneration error, etc.
Utility Functions		Gain adjustment, alarm history, jogging, origin search, etc.
Safety Functions	Inputs	/HWBB1 and /HWBB2: Base block signals for Power Modules
	Output	EDM1: Monitors the status of built-in safety circuit (fixed output).
	Applicable Standards*3	ISO13849-1 PLe (Category 3), IEC61508 SIL3
Option Module		Fully-Closed Modules and Safety Modules Note: You cannot use a Fully-Closed Module and a Safety Module together.

*1. If you combine a Σ-7-Series SERVOPACK with a Σ-V-Series Option Module, the following Σ-V-Series SERVO-PACKs specifications must be used: a surrounding air temperature of 0°C to 55°C and an altitude of 1,000 m max. Also, the applicable range cannot be increased by derating.

*2. The coefficient of speed fluctuation for load fluctuation is defined as follows:

$$\text{Coefficient of speed fluctuation} = \frac{\text{No-load motor speed} - \text{Total-load motor speed}}{\text{Rated motor speed}} \times 100\%$$

*3. Always perform risk assessment for the system and confirm that the safety requirements are met.

Derating Specifications

If you use the SERVOPACK at a surrounding air temperature of 55°C to 60°C or at an altitude of 1,000 m to 2,000 m, you must apply the derating rates given in the following graphs.

◆ SGD7S-R70A, -R90A, -1R6A, -2R8A, -R70F, -R90F, -2R1F, and -2R8F

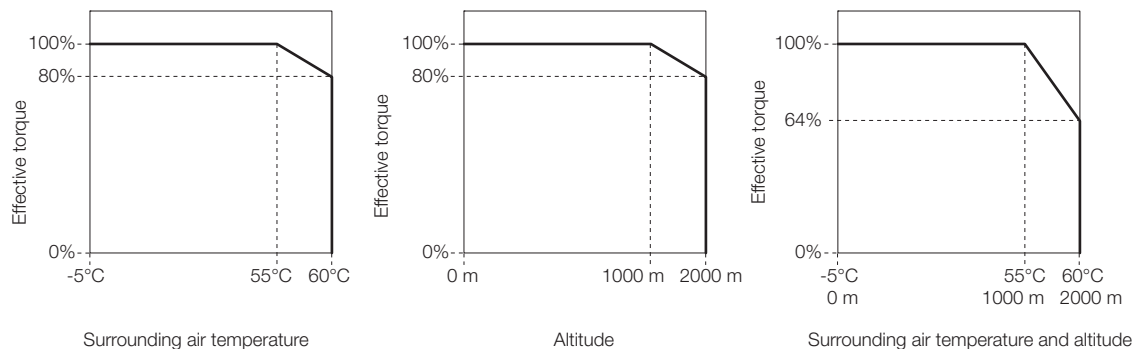

◆ SGD7S-3R8A, -5R5A, -7R6A, -120A, -180A, -200A, -330A, -470A, -550A, -590A, and -780A

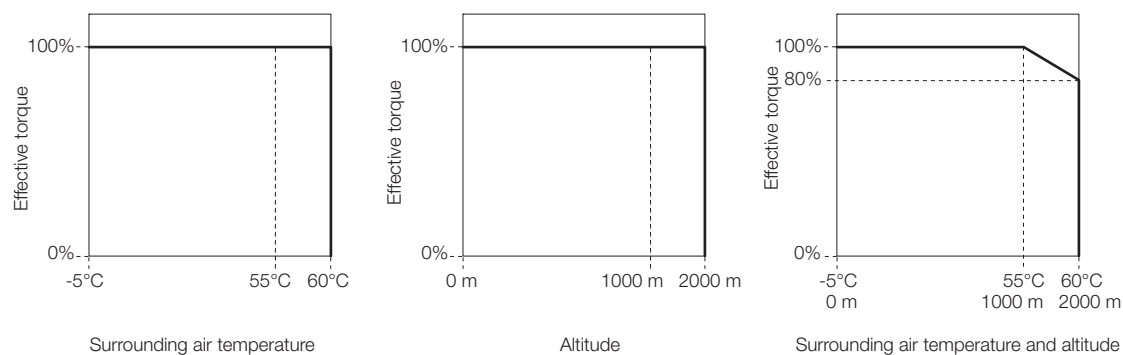

Selecting Cables

◆ System Configurations

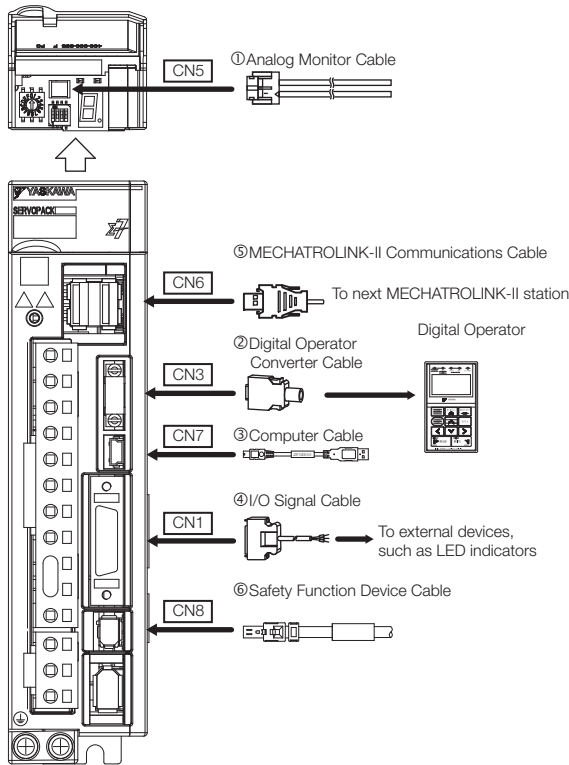

◆ Selection Table



1. Use the cable specified by Yaskawa for the Computer Cable. Operation may not be dependable with any other cable.
2. Use the cable specified by Yaskawa for the MECHATROLINK Communications Cables. Operation may not be dependable due to low noise resistance with any other cable.

Note: Refer to the following manual for the following information.





- Cable dimensional drawings and cable connection specifications
- Order numbers and specifications of individual connectors for cables

📖 *Σ-7-Series AC Servo Drive Peripheral Device Selection Manual (Manual No.: SIEP S800001 32)*

Code	Name	Length (L)	Order Number	Appearance
①	Analog Monitor Cable	1 m	JZSP-CA01-E	
②	Digital Operator Converter Cable	0.3 m	JZSP-CVS05-A3-E*1	
③	Computer Cable	2.5 m	JZSP-CVS06-02-E	

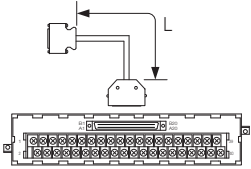
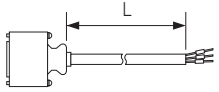
Continued on next page.

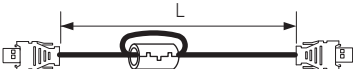
Continued from previous page.

Code	Name	Length (L)	Order Number	Appearance	
④	I/O Signal Cables	Soldered Connector Kit	JZSP-CSI9-2-E		
		Connector-Terminal Block Converter Unit (with cable)	0.5 m	JUSP-TA26P-E	
			1 m	JUSP-TA26P-1-E	
			2 m	JUSP-TA26P-2-E	
		Cable with Loose Wires at One End (loose wires on peripheral device end)	1 m	JZSP-CSI02-1-E	
			2 m	JZSP-CSI02-2-E	
			3 m	JZSP-CSI02-3-E	
⑤	MECHATRO LINK-II Communications Cables	Cables with Connectors on Both Ends	0.5 m	JEPMC-W6002-A5-E	
			1 m	JEPMC-W6002-01-E	
			3 m	JEPMC-W6002-03-E	
			5 m	JEPMC-W6002-05-E	
			10 m	JEPMC-W6002-10-E	
			20 m	JEPMC-W6002-20-E	
			30 m	JEPMC-W6002-30-E	
			40 m	JEPMC-W6002-40-E	
		Cables with Connectors on Both Ends (with ferrite cores)	0.5 m	JEPMC-W6003-A5-E	
			1 m	JEPMC-W6003-01-E	
			3 m	JEPMC-W6003-03-E	
			5 m	JEPMC-W6003-05-E	
			10 m	JEPMC-W6003-10-E	
			20 m	JEPMC-W6003-20-E	
			30 m	JEPMC-W6003-30-E	
		Terminators		JEPMC-W6022-E	
⑥	Safety Function Device Cables	Cables with Connectors*2	1 m	JZSP-CVH03-01-E	
			3 m	JZSP-CVH03-03-E	
	Connector Kit*3		Contact Tyco Electronics Japan G.K. Product name: Industrial Mini I/O D-shape Type 1 Plug Connector Kit Model number: 2013595-1		

*1. This Converter Cable is required to use the Σ-III-series Digital Operator (JUSP-OP05A) for Σ-7-series SERVOPACKs.

*2. When using safety functions, connect this Cable to the safety function devices.
When not using safety functions, connect the enclosed Safety Jumper Connector (JZSP-CVH05-E) to the SERVOPACK.

*3. Use the Connector Kit when you make cables yourself.

Σ-7S Single-axis MECHATROLINK-III Communications Reference SERVOPACKs

Model Designations

SGD7S - **R70** **A** **20** **A** **001** **000** **B**
 Σ-7 Series
 Σ-7S SERVOPACKs

1st+2nd+3rd digits Maximum Applicable Motor Capacity

Voltage	Code	Specification
Three-phase, 200 VAC	R70*1	0.05 kW
	R90*1	0.1 kW
	1R6*1	0.2 kW
	2R8*1	0.4 kW
	3R8	0.5 kW
	5R5*1	0.75 kW
	7R6	1.0 kW
	120*2	1.5 kW
	180	2.0 kW
	200*3	3.0 kW
	330	5.0 kW
	470	6.0 kW
	550	7.5 kW
590	11 kW	
780	15 kW	
Single-phase, 100 VAC	R70	0.05 kW
	R90	0.1 kW
	2R1	0.2 kW
	2R8	0.4 kW

4th digit Voltage

Code	Specification
A	200 VAC
F	100 VAC

5th+6th digits Interface*4

Code	Specification
20	MECHATROLINK-III communications reference

7th digit Design Revision Order

A

8th+9th+10th digits Hardware Options Specification

Code	Specification	Applicable Models
None 000	Without options	All models
001	Rack-mounted	SGD7S-R70A to -330A SGD7S-R70F to -2R8F
	Duct-ventilated	SGD7S-470A to -780A
002	Varnished	All models
008	Single-phase, 200-VAC power supply input	SGD7S-120A
020*5	No dynamic brake	SGD7S-R70A to -2R8A SGD7S-R70F to -2R8F
	External dynamic brake resistor	SGD7S-3R8A to -780A

11th+12th+13th digits FT/EX Specification

Code	Specification
None 000	None

14th digit BTO Specification*6
(Available in Japan only)

Code	Specification
None	None
B	BTO Specification

*1. You can use these models with either a single-phase or three-phase power supply input.

*2. A model with a single-phase, 200-VAC power supply input is available as a hardware option (model: SGD7S-120A20A008).

*3. The rated output is 2.4 kW if you combine the SGM7G-30A with the SGD7S-200A.

*4. The same SERVOPACKs are used for both Rotary Servomotors and Linear Servomotors.

*5. Refer to the following manual for details.

📖 *Σ-7-Series AC Servo Drive Σ-7S/Σ-7W SERVOPACK with Hardware Option Specifications Dynamic Brake Product Manual* (Manual No.: SIEP S800001 73)

*6. The BTO specification indicates if the SERVOPACK is customized by using the MechatroCloud BTO service.

You need a BTO number to order SERVOPACKs with customized specifications.

Refer to page M-15 for the details on the BTO service.

Ratings and Specifications

Ratings

◆ Three-phase, 200 VAC

Model SGD7S-		R70A	R90A	1R6A	2R8A	3R8A	5R5A	7R6A	120A	180A	200A	330A	
Maximum Applicable Motor Capacity [kW]		0.05	0.1	0.2	0.4	0.5	0.75	1.0	1.5	2.0	3.0	5.0	
Continuous Output Current [Arms]		0.66	0.91	1.6	2.8	3.8	5.5	7.6	11.6	18.5	19.6	32.9	
Instantaneous Maximum Output Current [Arms]		2.1	3.2	5.9	9.3	11	16.9	17	28	42	56	84.0	
Main Circuit	Power Supply	200 VAC to 240 VAC, -15% to +10%, 50 Hz/60 Hz											
	Input Current [Arms]*	0.4	0.8	1.3	2.5	3.0	4.1	5.7	7.3	10	15	25	
Control	Power Supply	200 VAC to 240 VAC, -15% to +10%, 50 Hz/60 Hz											
	Input Current [Arms]*	0.2	0.2	0.2	0.2	0.2	0.2	0.2	0.2	0.25	0.25	0.3	
Power Supply Capacity [kVA]*		0.2	0.3	0.5	1.0	1.3	1.6	2.3	3.2	4.0	5.9	7.5	
Power Loss*	Main Circuit Power Loss [W]	5.0	7.0	11.9	22.5	28.5	38.9	49.2	72.6	104.2	114.2	226.6	
	Control Circuit Power Loss [W]	12	12	12	12	14	14	14	15	16	16	19	
	Built-in Regenerative Resistor Power Loss [W]	-	-	-	-	8	8	8	10	16	16	36	
	Total Power Loss [W]	17.0	19.0	23.9	34.5	50.5	60.9	71.2	97.6	136.2	146.2	281.6	
Regenerative Resistor	Built-In Regenerative Resistor	Resistance [Ω]	-	-	-	-	40	40	40	20	12	12	8
		Capacity [W]	-	-	-	-	40	40	40	60	60	60	180
	Minimum Allowable External Resistance [Ω]		40	40	40	40	40	40	40	20	12	12	8
Overvoltage Category		III											

* This is the net value at the rated load.

Model SGD7S-		470A	550A	590A	780A	
Maximum Applicable Motor Capacity [kW]		6.0	7.5	11	15	
Continuous Output Current [Arms]		46.9	54.7	58.6	78.0	
Instantaneous Maximum Output Current [Arms]		110	130	140	170	
Main Circuit	Power Supply	200 VAC to 240 VAC, -15% to +10%, 50 Hz/60 Hz				
	Input Current [Arms] ^{*1}	29	37	54	73	
Control	Power Supply	200 VAC to 240 VAC, -15% to +10%, 50 Hz/60 Hz				
	Input Current [Arms] ^{*1}	0.3	0.3	0.4	0.4	
Power Supply Capacity [kVA] ^{*1}		10.7	14.6	21.7	29.6	
Power Loss ^{*1}	Main Circuit Power Loss [W]	271.7	326.9	365.3	501.4	
	Control Circuit Power Loss [W]	21	21	28	28	
	External Regenerative Resistor Unit Power Loss [W]	180 ^{*2}	180 ^{*3}	350 ^{*3}	350 ^{*3}	
	Total Power Loss [W]	292.7	347.9	393.3	529.4	
External Regenerative Resistor Unit	External Regenerative Resistor Unit	Resistance [Ω]	6.25 ^{*2}	3.13 ^{*3}	3.13 ^{*3}	3.13 ^{*3}
		Capacity [W]	880 ^{*2}	1760 ^{*3}	1760 ^{*3}	1760 ^{*3}
	Minimum Allowable External Resistance [Ω]		5.8	2.9	2.9	2.9
Overvoltage Category		III				

*1. This is the net value at the rated load.

*2. This value is for the optional JUSP-RA04-E Regenerative Resistor Unit.

*3. This value is for the optional JUSP-RA05-E Regenerative Resistor Unit.

SERVOPACKs

Σ-7S Single-axis MECHATROLINK-III Communications Reference SERVOPACKs

◆ **Single-phase, 200 VAC**

Model SGD7S-		R70A	R90A	1R6A	2R8A	5R5A	120A
Maximum Applicable Motor Capacity [kW]		0.05	0.1	0.2	0.4	0.75	1.5
Continuous Output Current [Arms]		0.66	0.91	1.6	2.8	5.5	11.6
Instantaneous Maximum Output Current [Arms]		2.1	3.2	5.9	9.3	16.9	28
Main Circuit	Power Supply	200 VAC to 240 VAC, -15% to +10%, 50 Hz/60 Hz					
	Input Current [Arms]*	0.8	1.6	2.4	5.0	8.7	16
Control	Power Supply	200 VAC to 240 VAC, -15% to +10%, 50 Hz/60 Hz					
	Input Current [Arms]*	0.2	0.2	0.2	0.2	0.2	0.25
Power Supply Capacity [kVA]*		0.2	0.3	0.6	1.2	1.9	4.0
Power Loss*	Main Circuit Power Loss [W]	5.0	7.1	12.1	23.7	39.2	71.8
	Control Circuit Power Loss [W]	12	12	12	12	14	16
	Built-in Regenerative Resistor Power Loss [W]	-	-	-	-	8	16
	Total Power Loss [W]	17.0	19.1	24.1	35.7	61.2	103.8
Regenerative Resistor	Built-In Regenerative Resistor	Resistance [Ω]	-	-	-	40	12
		Capacity [W]	-	-	-	40	60
	Minimum Allowable External Resistance [Ω]	40	40	40	40	40	12
Overvoltage Category		III					

* This is the net value at the rated load.

◆ **270 VDC**

Model SGD7S-		R70A	R90A	1R6A	2R8A	3R8A	5R5A	7R6A	120A
Maximum Applicable Motor Capacity [kW]		0.05	0.1	0.2	0.4	0.5	0.75	1.0	1.5
Continuous Output Current [Arms]		0.66	0.91	1.6	2.8	3.8	5.5	7.6	11.6
Instantaneous Maximum Output Current [Arms]		2.1	3.2	5.9	9.3	11.0	16.9	17.0	28.0
Main Circuit	Power Supply	270 VDC to 324 VDC, -15% to +10%							
	Input Current [Arms]* ¹	0.5	1.0	1.5	3.0	3.8	4.9	6.9	11
Control	Power Supply	270 VDC to 324 VDC, -15% to +10%							
	Input Current [Arms]* ¹	0.2	0.2	0.2	0.2	0.2	0.2	0.2	0.2 ²
Power Supply Capacity [kVA]* ¹		0.2	0.3	0.6	1	1.4	1.6	2.3	3.2
Power Loss* ¹	Main Circuit Power Loss [W]	4.4	5.9	9.8	17.5	23.0	30.7	38.7	55.8
	Control Circuit Power Loss [W]	12	12	12	12	14	14	14	15
	Total Power Loss [W]	16.4	17.9	21.8	29.5	37.0	44.7	52.7	70.8
Overvoltage Category		III							

*1. This is the net value at the rated load.

*2. The value is 0.25 Arms for the SGD7S-120A00A008.

Model SGD7S-		180A	200A	330A	470A	550A	590A	780A
Maximum Applicable Motor Capacity [kW]		2.0	3.0	5.0	6.0	7.5	11.0	15.0
Continuous Output Current [Arms]		18.5	19.6	32.9	46.9	54.7	58.6	78.0
Instantaneous Maximum Output Current [Arms]		42.0	56.0	84.0	110	130	140	170
Main Circuit	Power Supply	270 VDC to 324 VDC, -15% to +10%						
	Input Current [Arms]*	14	20	34	36	48	68	92
Control	Power Supply	270 VDC to 324 VDC, -15% to +10%						
	Input Current [Arms]*	0.25	0.25	0.3	0.3	0.3	0.4	0.4
Power Supply Capacity [kVA]*		4.0	5.9	7.5	10.7	14.6	21.7	29.6
Power Loss*	Main Circuit Power Loss [W]	82.7	83.5	146.2	211.6	255.3	243.6	343.4
	Control Circuit Power Loss [W]	16	16	19	21	21	28	28
	Total Power Loss [W]	98.7	99.5	165.2	232.6	276.3	271.6	371.4
Overvoltage Category		III						

* This is the net value at the rated load.

◆ Single-phase, 100 VAC

Model SGD7S-		R70F	R90F	2R1F	2R8F
Maximum Applicable Motor Capacity [kW]		0.05	0.1	0.2	0.4
Continuous Output Current [Arms]		0.66	0.91	2.1	2.8
Instantaneous Maximum Output Current [Arms]		2.1	3.2	6.5	9.3
Main Circuit	Power Supply	100 VAC to 120 VAC, -15% to +10%, 50 Hz/60 Hz			
	Input Current [Arms]*	1.5	2.5	5	10
Control	Power Supply	100 VAC to 120 VAC, -15% to +10%, 50 Hz/60 Hz			
	Input Current [Arms]*	0.38	0.38	0.38	0.38
Power Supply Capacity [kVA]*		0.2	0.3	0.6	1.4
Power Loss*	Main Circuit Power Loss [W]	5.3	7.8	14.2	26.2
	Control Circuit Power Loss [W]	12	12	12	12
	Total Power Loss [W]	17.3	19.8	26.2	38.2
Regenerative Resistor	Minimum Allowable External Resistance [Ω]	40	40	40	40
Overvoltage Category		III			

* This is the net value at the rated load.

SERVOPACK Overload Protection Characteristics

The overload detection level is set for hot start conditions with a SERVOPACK surrounding air temperature of 55°C.

An overload alarm (A.710 or A.720) will occur if overload operation that exceeds the overload protection characteristics shown in the following diagram (i.e., operation on the right side of the applicable line) is performed.

The actual overload detection level will be the detection level of the connected SERVOPACK or Servomotor that has the lower overload protection characteristics.

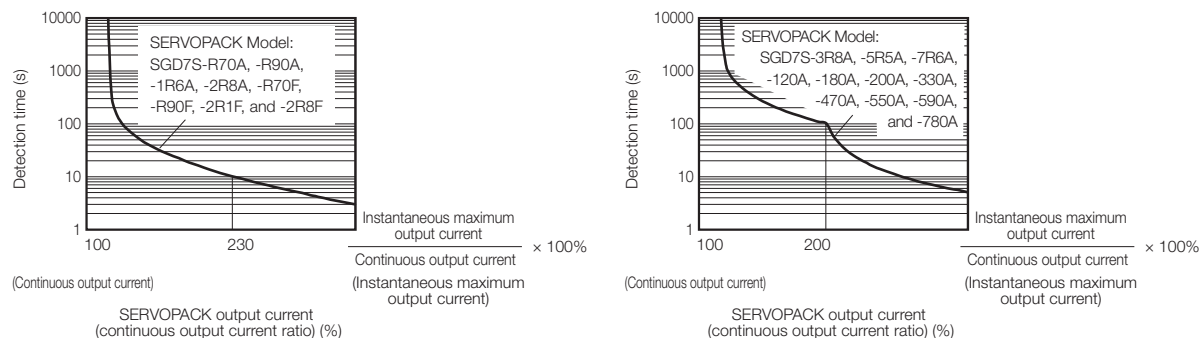

In most cases, that will be the overload protection characteristics of the Servomotor.



Note: The above overload protection characteristics do not mean that you can perform continuous duty operation with an output of 100% or higher.

For a Yaskawa-specified combination of SERVOPACK and Servomotor, maintain the effective torque (or effective force) within the continuous duty zone of the torque-motor speed characteristic (or force-motor speed characteristics) of the Servomotor.

Specifications

Item		Specification								
Drive Method		IGBT-based PWM control, sine wave current drive								
Feedback	With Rotary Servomotor	Serial encoder: 17 bits (absolute encoder) 20 bits or 24 bits (incremental encoder/absolute encoder) 22 bits (absolute encoder)								
	With Linear Servomotor	<ul style="list-style-type: none"> Absolute linear encoder (The signal resolution depends on the absolute linear encoder.) Incremental linear encoder (The signal resolution depends on the incremental linear encoder or Serial Converter Unit.) 								
Surrounding Air Temperature*1		-5°C to 55°C With derating, usage is possible between 55°C and 60°C. Refer to the following section for derating specifications.  <i>Derating Specifications (page 353)</i>								
Storage Temperature		-20°C to 85°C								
Surrounding Air Humidity		95% relative humidity max. (with no freezing or condensation)								
Storage Humidity		95% relative humidity max. (with no freezing or condensation)								
Vibration Resistance		4.9 m/s ²								
Shock Resistance		19.6 m/s ²								
Environmental Conditions	Degree of Protection	<table border="1"> <thead> <tr> <th>Class</th> <th>SERVOPACK Model: SGD7S-</th> </tr> </thead> <tbody> <tr> <td>IP20</td> <td>R70A, R90A, 1R6A, 2R8A, 3R8A, 5R5A, 7R6A, 120A, R70F, R90F, 2R1F, 2R8F</td> </tr> <tr> <td>IP10</td> <td>120A20A008, 180A, 200A, 330A, 470A, 550A, 590A, 780A</td> </tr> </tbody> </table>	Class	SERVOPACK Model: SGD7S-	IP20	R70A, R90A, 1R6A, 2R8A, 3R8A, 5R5A, 7R6A, 120A, R70F, R90F, 2R1F, 2R8F	IP10	120A20A008, 180A, 200A, 330A, 470A, 550A, 590A, 780A		
		Class	SERVOPACK Model: SGD7S-							
		IP20	R70A, R90A, 1R6A, 2R8A, 3R8A, 5R5A, 7R6A, 120A, R70F, R90F, 2R1F, 2R8F							
	IP10	120A20A008, 180A, 200A, 330A, 470A, 550A, 590A, 780A								
	Pollution Degree	2 <ul style="list-style-type: none"> Must be no corrosive or flammable gases. Must be no exposure to water, oil, or chemicals. Must be no dust, salts, or iron dust. 								
Altitude*1	1,000 m or less. With derating, usage is possible between 1,000 m and 2,000 m. Refer to the following section for derating specifications.  <i>Derating Specifications (page 353)</i>									
Others	Do not use the SERVOPACK in the following locations: Locations subject to static electricity noise, strong electromagnetic/magnetic fields, or radioactivity									
Applicable Standards		UL 61800-5-1 (E147823), CSA C22.2 No.274, EN ISO13849-1: 2015, EN 55011 group 1 class A, EN 61000-6-2, EN 61000-6-4, EN 61800-3 (Category C2, Second environment), EN 50178, EN 61800-5-1, IEC 60204-1, IEC 61508 series, IEC 62061, IEC 61800-5-2, and IEC 61326-3-1								
Mounting		<table border="1"> <thead> <tr> <th>Mounting</th> <th>SERVOPACK Model: SGD7S-</th> </tr> </thead> <tbody> <tr> <td>Base-mounted</td> <td>All Models</td> </tr> <tr> <td>Rack-mounted</td> <td>R70A, R90A, 1R6A, 2R8A, 3R8A, 5R5A, 7R6A, 120A, 180A, 200A, 330A, R70F, R90F, 2R1F, 2R8F</td> </tr> <tr> <td>Duct-ventilated</td> <td>470A, 550A, 590A, 780A</td> </tr> </tbody> </table>	Mounting	SERVOPACK Model: SGD7S-	Base-mounted	All Models	Rack-mounted	R70A, R90A, 1R6A, 2R8A, 3R8A, 5R5A, 7R6A, 120A, 180A, 200A, 330A, R70F, R90F, 2R1F, 2R8F	Duct-ventilated	470A, 550A, 590A, 780A
		Mounting	SERVOPACK Model: SGD7S-							
		Base-mounted	All Models							
		Rack-mounted	R70A, R90A, 1R6A, 2R8A, 3R8A, 5R5A, 7R6A, 120A, 180A, 200A, 330A, R70F, R90F, 2R1F, 2R8F							
Duct-ventilated	470A, 550A, 590A, 780A									
Speed Control Range	1:5000 (At the rated torque, the lower limit of the speed control range must not cause the Servomotor to stop.)									
Coefficient of Speed Fluctuation*2	±0.01% of rated speed max. (for a load fluctuation of 0% to 100%)									
	0% of rated speed max. (for a voltage fluctuation of ±10%)									
	±0.1% of rated speed max. (for a temperature fluctuation of 25°C ±25°C)									
Torque Control Precision (Repeatability)	±1%									
Soft Start Time Setting	0 s to 10 s (Can be set separately for acceleration and deceleration.)									

Continued on next page.

Continued from previous page.

Item		Specification	
I/O Signals	Encoder Divided Pulse Output	Phase A, phase B, phase C: Line-driver output Number of divided output pulses: Any setting is allowed.	
	Overheat Protection Input	Number of input points: 1 Input voltage range: 0 V to +5 V	
	Sequence Input Signals	Input Signals That Can Be Allocated	Allowable voltage range: 24 VDC ±20% Number of input points: 7 Input method: Sink inputs or source inputs Input Signals <ul style="list-style-type: none"> • P-OT (Forward Drive Prohibit) and N-OT (Reverse Drive Prohibit) signals • /P-CL (Forward External Torque Limit) and /N-CL (Reverse External Torque Limit) signals • /DEC (Origin Return Deceleration Switch) signal • /EXT1 to /EXT3 (External Latch Input 1 to 3) signals • FSTP (Forced Stop Input) signal A signal can be allocated and the positive and negative logic can be changed.
		Fixed Output	Allowable voltage range: 5 VDC to 30 VDC Number of output points: 1 Output signal: Servo Alarm (ALM)
	Sequence Output Signals	Output Signals That Can Be Allocated	Allowable voltage range: 5 VDC to 30 VDC Number of output points: 3 (A photocoupler output (isolated) is used.) Output Signals <ul style="list-style-type: none"> • /COIN (Positioning Completion) signal • /V-CMP (Speed Coincidence Detection) signal • /TGON (Rotation Detection) signal • /S-RDY (Servo Ready) signal • /CLT (Torque Limit Detection) signal • /VLT (Speed Limit Detection) signal • /BK (Brake) signal • /WARN (Warning) signal • /NEAR (Near) signal A signal can be allocated and the positive and negative logic can be changed.
		Interfaces	Digital Operator (JUSP-OP05A-1-E) and personal computer (with SigmaWin+)
Communications	RS-422A Communications (CN3)	1:N Communications	Up to N = 15 stations possible for RS-422A port
		Axis Address Setting	03 to EF hex (maximum number of slaves: 62) The rotary switches (S1 and S2) are used to set the station address.
	USB Communications (CN7)	Interface	Personal computer (with SigmaWin+)
Communications Standard		Conforms to USB2.0 standard (12 Mbps).	
Displays/Indicators		CHARGE, PWR, CN, L1, and L2 indicators, and one-digit seven-segment display	
MECHATROLINK-III Communications	Communications Protocol	MECHATROLINK-III	
	Station Address Settings	03 to EF hex (maximum number of slaves: 62) The rotary switches (S1 and S2) are used to set the station address.	
	Baud Rate	100 Mbps	
	Transmission Cycle	125 μs, 250 μs, 500 μs, 750 μs, 1.0 ms to 4.0 ms (multiples of 0.5 ms)	
	Number of Transmission Bytes	32 or 48 bytes/station A DIP switch (S3) is used to select the number of transmission bytes.	
Reference Method	Performance	Position, speed, or torque control with MECHATROLINK-III communications	
	Reference Input	MECHATROLINK-III commands (sequence, motion, data setting, data access, monitoring, adjustment, etc.)	
	Profile	MECHATROLINK-III standard servo profile	

Continued on next page.

SERVOPACKs

Σ-7S Single-axis MECHATROLINK-III Communications Reference SERVOPACKs

Continued from previous page.

Item		Specification
MECHATROLINK-III Communications Setting Switches		Rotary switch (S1 and S2) positions: 16 Number of DIP switch (S3) pins: 4
Analog Monitor (CN5)		Number of points: 2 Output voltage range: ±10 VDC (effective linearity range: ±8 V) Resolution: 16 bits Accuracy: ±20 mV (Typ) Maximum output current: ±10 mA Settling time (±1%): 1.2 ms (Typ)
Dynamic Brake (DB)		Activated when a servo alarm or overtravel (OT) occurs, or when the power supply to the main circuit or servo is OFF.
Regenerative Processing		Built-in (An external resistor must be connected to the SGD7S-470A to -780A.)  <i>Built-In Regenerative Resistor (page 472)</i>
Overtravel (OT) Prevention		Stopping with dynamic brake, deceleration to a stop, or coasting to a stop for the P-OT (Forward Drive Prohibit) or N-OT (Reverse Drive Prohibit) signal
Protective Functions		Overcurrent, overvoltage, low voltage, overload, regeneration error, etc.
Utility Functions		Gain adjustment, alarm history, jogging, origin search, etc.
Safety Functions	Inputs	/HWBB1 and /HWBB2: Base block signals for Power Modules
	Output	EDM1: Monitors the status of built-in safety circuit (fixed output).
	Applicable Standards*3	ISO13849-1 PLe (Category 3), IEC61508 SIL3
Option Module		Fully-Closed Modules and Safety Modules Note: You cannot use a Fully-Closed Module and a Safety Module together.

*1. If you combine a Σ-7-Series SERVOPACK with a Σ-V-Series Option Module, the following Σ-V-Series SERVO-PACKs specifications must be used: a surrounding air temperature of 0°C to 55°C and an altitude of 1,000 m max. Also, the applicable range cannot be increased by derating.

*2. The coefficient of speed fluctuation for load fluctuation is defined as follows:

$$\text{Coefficient of speed fluctuation} = \frac{\text{No-load motor speed} - \text{Total-load motor speed}}{\text{Rated motor speed}} \times 100\%$$

*3. Always perform risk assessment for the system and confirm that the safety requirements are met.

Derating Specifications

If you use the SERVOPACK at a surrounding air temperature of 55°C to 60°C or at an altitude of 1,000 m to 2,000 m, you must apply the derating rates given in the following graphs.

◆ SGD7S-R70A, -R90A, -1R6A, -2R8A, -R70F, -R90F, -2R1F, and -2R8F

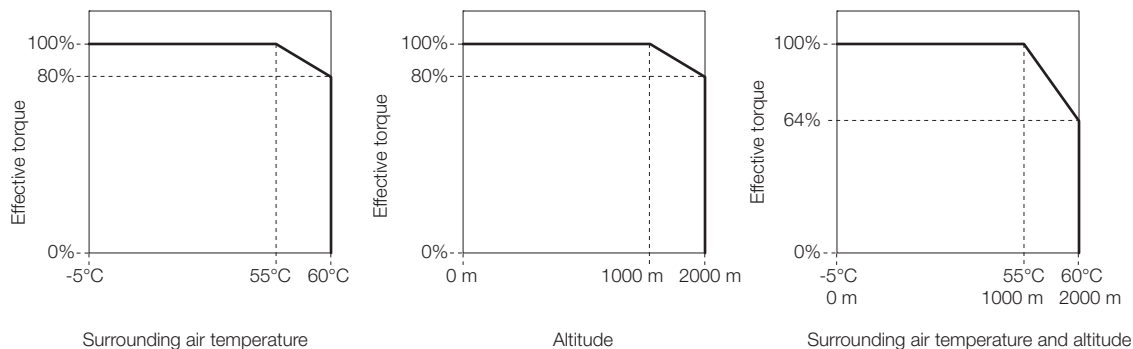

◆ SGD7S-3R8A, -5R5A, -7R6A, -120A, -180A, -200A, -330A, -470A, -550A, -590A, and -780A

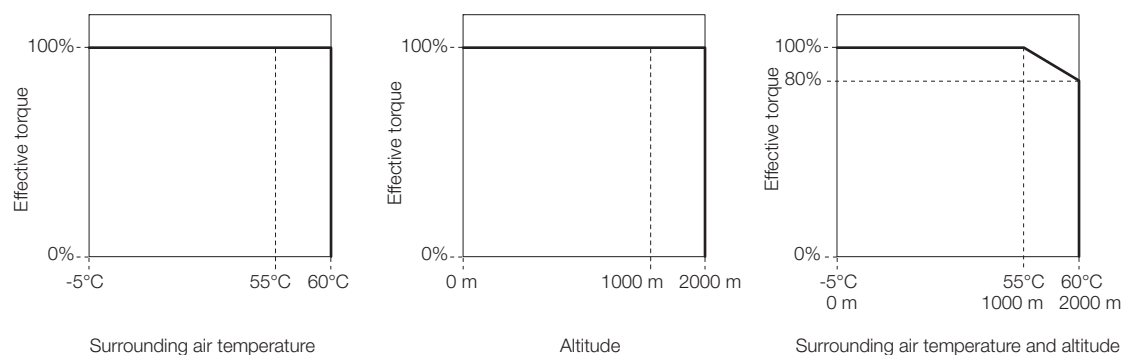

Selecting Cables

◆ System Configurations

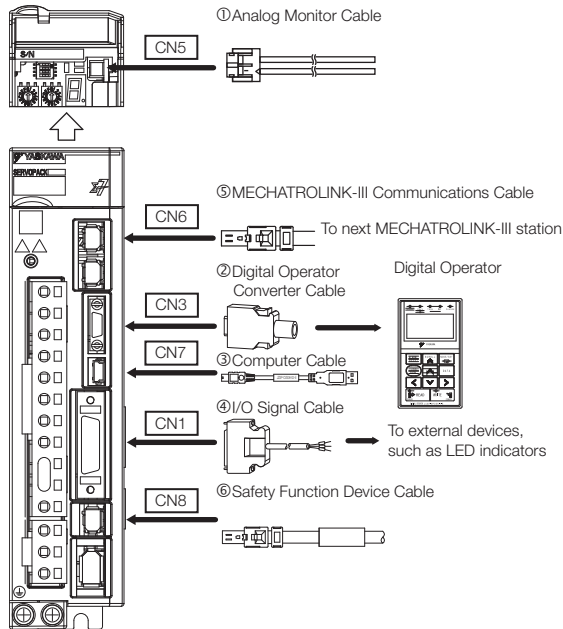

◆ Selection Table

Important

1. Use the cable specified by Yaskawa for the Computer Cable. Operation may not be dependable with any other cable.
2. Use the cable specified by Yaskawa for the MECHATROLINK Communications Cables. Operation may not be dependable due to low noise resistance with any other cable.



Note: Refer to the following manual for the following information.

- Cable dimensional drawings and cable connection specifications
 - Order numbers and specifications of individual connectors for cables
- 📖 *Σ-7-Series AC Servo Drive Peripheral Device Selection Manual (Manual No.: SIEP S800001 32)*

Code	Name	Length (L)	Order Number	Appearance
①	Analog Monitor Cable	1 m	JZSP-CA01-E	
②	Digital Operator Converter Cable	0.3 m	JZSP-CVS05-A3-E*1	
			JZSP-CVS07-A3-E*2	
③	Computer Cable	2.5 m	JZSP-CVS06-02-E	

Continued on next page.

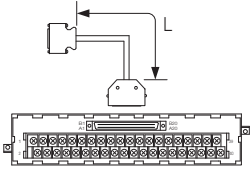
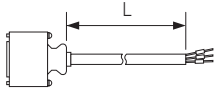
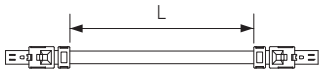
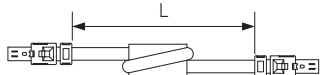
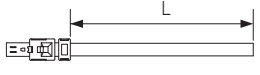
Continued from previous page.

Code	Name	Length (L)	Order Number	Appearance	
④	I/O Signal Cables	Soldered Connector Kit	JZSP-CSI9-2-E		
		Connector-Terminal Block Converter Unit (with cable)	0.5 m	JUSP-TA26P-E	
			1 m	JUSP-TA26P-1-E	
			2 m	JUSP-TA26P-2-E	
		Cable with Loose Wires at One End (loose wires on peripheral device end)	1 m	JZSP-CSI02-1-E	
			2 m	JZSP-CSI02-2-E	
			3 m	JZSP-CSI02-3-E	
⑤	MECHATROLINK-III Communications Cables	Cables with Connectors on Both Ends	0.2 m	JEPMC-W6012-A2-E	
			0.5 m	JEPMC-W6012-A5-E	
			1 m	JEPMC-W6012-01-E	
			2 m	JEPMC-W6012-02-E	
			3 m	JEPMC-W6012-03-E	
			4 m	JEPMC-W6012-04-E	
			5 m	JEPMC-W6012-05-E	
			10 m	JEPMC-W6012-10-E	
			20 m	JEPMC-W6012-20-E	
		30 m	JEPMC-W6012-30-E		
		50 m	JEPMC-W6012-50-E		
		Cables with Connectors on Both Ends (with core)	10 m	JEPMC-W6013-10-E	
			20 m	JEPMC-W6013-20-E	
			30 m	JEPMC-W6013-30-E	
			50 m	JEPMC-W6013-50-E	
		Cable with Loose Wires at One End	0.5 m	JEPMC-W6014-A5-E	
			1 m	JEPMC-W6014-01-E	
			3 m	JEPMC-W6014-03-E	
			5 m	JEPMC-W6014-05-E	
10 m	JEPMC-W6014-10-E				
30 m	JEPMC-W6014-30-E				
50 m	JEPMC-W6014-50-E				
⑥	Safety Function Device Cables	Cables with Connectors* ³	1 m	JZSP-CVH03-01-E	
			3 m	JZSP-CVH03-03-E	
		Connector Kit* ⁴	Contact Tyco Electronics Japan G.K. Product name: Industrial Mini I/O D-shape Type 1 Plug Connector Kit Model number: 2013595-1		

*1. This Converter Cable is required to use the Σ-III-series Digital Operator (JUSP-OP05A) for Σ-7-series SERVOPACKs.

*2. If you use a MECHATROLINK-III Communications Reference SERVOPACK, this Converter Cable is required to prevent the cable from disconnecting from the Digital Operator.

*3. When using safety functions, connect this Cable to the safety function devices.

When not using safety functions, connect the enclosed Safety Jumper Connector (JZSP-CVH05-E) to the SERVOPACK.

*4. Use the Connector Kit when you make cables yourself.

Σ-7S Single-axis INDEXER Module-Mounted SERVOPACKs

Configuration

A Σ-7S Single-axis INDEXER Module-Mounted SERVOPACK is a Command Option Attachable-Type SERVOPACK with an INDEXER Module mounted on the side of the SERVOPACK. Positioning with single-axis control can be performed by using program table operation and other functions.

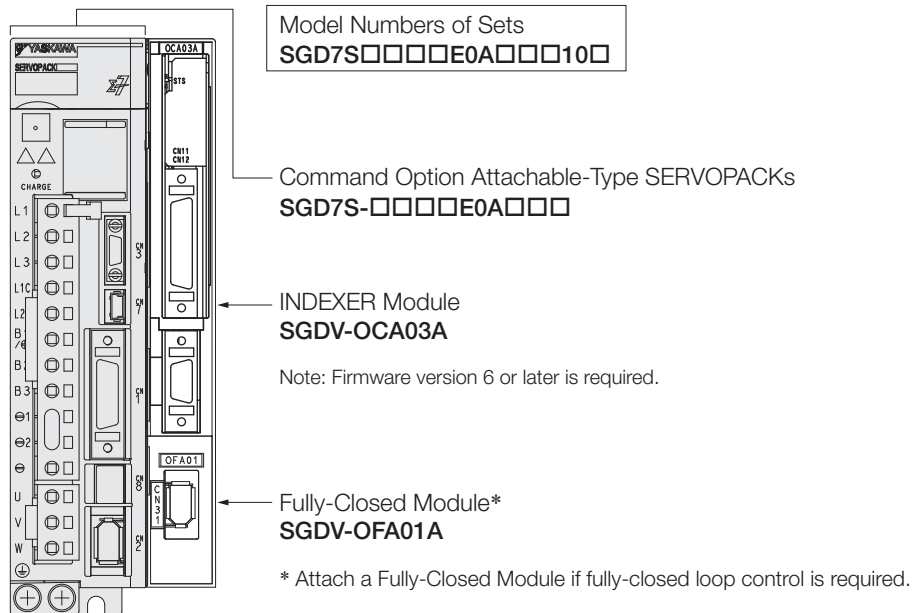

Purchase Order Number

Purchasing a Module in a Set with the SERVOPACK

To order SERVOPACKs with a INDEXER Module attached, use the following model numbers.

SGD7S *1 R70 A E0 A 000 100

Σ-7 Series Σ-7S SERVOPACKs 1st+2nd+3rd digits 4th digit 5th+6th digits 7th digit 8th+9th+10th digits 11th+12th+13th digits

1st+2nd+3rd digits Maximum Applicable Motor Capacity

Voltage	Code	Specification
Three-phase, 200 VAC	R70 ^{*2}	0.05 kW
	R90 ^{*2}	0.1 kW
	1R6 ^{*2}	0.2 kW
	2R8 ^{*2}	0.4 kW
	3R8	0.5 kW
	5R5 ^{*2}	0.75 kW
	7R6	1.0 kW
	120 ^{*3}	1.5 kW
	180	2.0 kW
	200 ^{*4}	3.0 kW
	330	5.0 kW
	470	6.0 kW
	550	7.5 kW
590	11 kW	
780	15 kW	
Single-phase, 100 VAC	R70	0.05 kW
	R90	0.1 kW
	2R1	0.2 kW
	2R8	0.4 kW

4th digit Voltage

Code	Specification
A	200 VAC
F	100 VAC

5th+6th digits Interface

Code	Specification
E0	Command Option Attachable Type

7th digit Design Revision Order

A

8th+9th+10th digits Hardware Options Specification

Code	Specification	Applicable Models
None	Without options	All models
001	Rack-mounted	SGD7S-R70A to -330A SGD7S-R70F to -2R8F
	Duct-ventilated	SGD7S-470A to -780A
002	Varnished	All models
008	Single-phase, 200-VAC power supply input	SGD7S-120A
020 ^{*5}	No dynamic brake	SGD7S-R70A to -2R8A SGD7S-R70F to -2R8F
	External dynamic brake resistor	SGD7S-3R8A to -780A

11th+12th+13th digits Option Module

Code	Specification
100	INDEXER Module
101	INDEXER Module + Fully-Closed Module

*1. The model number of a SERVOPACK with an Option Module is not hyphenated after SGD7S.

*2. You can use these models with either a single-phase or three-phase power supply input.

*3. A model with a single-phase, 200-VAC power supply input is available as a hardware option (model: SGD7S-120AE0A008).

*4. The rated output is 2.4 kW if you combine the SGM7G-30A with the SGD7S-200A.

*5. Refer to the following manual for details.

📖 *Σ-7-Series AC Servo Drive Σ-7S/Σ-7W SERVOPACK with Hardware Option Specifications Dynamic Brake Product Manual (Manual No.: SIEP S800001 73)*

Note: Contact your Yaskawa representative for information on combining options.

Purchasing a Module Separately

When ordering SERVOPACKs and Option Modules separately, use the following model numbers.

◆ SERVOPACK

SGD7S - R70 A E0 A 001 000 B

Σ-7 Series
Σ-7S SERVOPACKs

1st+2nd+3rd digits

4th digit

5th+6th digits

7th digit

8th+9th+10th digits

11th+12th+13th digits

14th digit

1st+2nd+3rd digits Maximum Applicable Motor Capacity

Voltage	Code	Specification
Three-phase, 200 VAC	R70*1	0.05 kW
	R90*1	0.1 kW
	1R6*1	0.2 kW
	2R8*1	0.4 kW
	3R8	0.5 kW
	5R5*1	0.75 kW
	7R6	1.0 kW
	120*2	1.5 kW
	180	2.0 kW
	200*3	3.0 kW
	330	5.0 kW
	470	6.0 kW
	550	7.5 kW
590	11 kW	
780	15 kW	
Single-phase, 100 VAC	R70	0.05 kW
	R90	0.1 kW
	2R1	0.2 kW
	2R8	0.4 kW

4th digit Voltage

Code	Specification
A	200 VAC
F	100 VAC

5th+6th digits Interface*4

Code	Specification
E0	Command Option Attachable Type

7th digit Design Revision Order
A

8th+9th+10th digits Hardware Options Specification

Code	Specification	Applicable Models
None	Without options	All models
000		
001	Rack-mounted	SGD7S-R70A to -330A SGD7S-R70F to -2R8F
	Duct-ventilated	SGD7S-470A to -780A
002	Varnished	All models
008	Single-phase, 200-VAC power supply input	SGD7S-120A
020*5	No dynamic brake	SGD7S-R70A to -2R8A SGD7S-R70F to -2R8F
	External dynamic brake resistor	SGD7S-3R8A to -780A

11th+12th+13th digits FT/EX Specification

Code	Specification
None	None
000	

14th digit BTO Specification*6

Code	Specification
None	None
B	BTO Specification

*1. You can use these models with either a single-phase or three-phase power supply input.

*2. A model with a single-phase, 200-VAC power supply input is available as a hardware option (model: SGD7S-120AE0A008).

*3. The rated output is 2.4 kW if you combine the SGM7G-30A with the SGD7S-200A.

*4. The same SERVOPACKs are used for both Rotary Servomotors and Linear Servomotors.

*5. Refer to the following manual for details.

 Σ-7-Series AC Servo Drive S-7S/S-7W SERVOPACK with Hardware Option Specifications Dynamic Brake Product Manual (Manual No.: SIEP S800001 73)

*6. The BTO specification indicates if the SERVOPACK is customized by using the MechatroCloud BTO service.

You need a BTO number to order SERVOPACKs with customized specifications.

Refer to page M-15 for the details on the BTO service.



Important

One Option Case Kit is required for each SERVOPACK.

Option Case Kit model: SGDVOZA01A

◆ INDEXER Module

SGDV-OCA03A

◆ Fully-Closed Module

SGDV-OFA01A

Ratings and Specifications

SERVOPACK Ratings

◆ Three-Phase, 200 VAC

Model SGD7S-		R70A	R90A	1R6A	2R8A	3R8A	5R5A	7R6A	120A	180A	200A	330A	
Maximum Applicable Motor Capacity [kW]		0.05	0.1	0.2	0.4	0.5	0.75	1.0	1.5	2.0	3.0	5.0	
Continuous Output Current [Arms]		0.66	0.91	1.6	2.8	3.8	5.5	7.6	11.6	18.5	19.6	32.9	
Instantaneous Maximum Output Current [Arms]		2.1	3.2	5.9	9.3	11	16.9	17	28	42	56	84.0	
Main Circuit	Power Supply	200 VAC to 240 VAC, -15% to +10%, 50 Hz/60 Hz											
	Input Current [Arms]*	0.4	0.8	1.3	2.5	3.0	4.1	5.7	7.3	10	15	25	
Control	Power Supply	200 VAC to 240 VAC, -15% to +10%, 50 Hz/60 Hz											
	Input Current [Arms]*	0.2	0.2	0.2	0.2	0.2	0.2	0.2	0.2	0.25	0.25	0.3	
Power Supply Capacity [kVA]*		0.2	0.3	0.5	1.0	1.3	1.6	2.3	3.2	4.0	5.9	7.5	
Power Loss*	Main Circuit Power Loss [W]	5.0	7.0	11.9	22.5	28.5	38.9	49.2	72.6	104.2	114.2	226.6	
	Control Circuit Power Loss [W]	12	12	12	12	14	14	14	15	16	16	19	
	Built-in Regenerative Resistor Power Loss [W]	–	–	–	–	8	8	8	10	16	16	36	
	Total Power Loss [W]	17.0	19.0	23.9	34.5	50.5	60.9	71.2	97.6	136.2	146.2	281.6	
Regenerative Resistor	Built-In Regenerative Resistor	Resistance [Ω]	–	–	–	–	40	40	40	20	12	12	8
		Capacity [W]	–	–	–	–	40	40	40	60	60	60	180
	Minimum Allowable External Resistance [Ω]		40	40	40	40	40	40	40	20	12	12	8
Overvoltage Category		III											

* This is the net value at the rated load.

Model SGD7S-		470A	550A	590A	780A	
Maximum Applicable Motor Capacity [kW]		6.0	7.5	11	15	
Continuous Output Current [Arms]		46.9	54.7	58.6	78.0	
Instantaneous Maximum Output Current [Arms]		110	130	140	170	
Main Circuit	Power Supply	200 VAC to 240 VAC, -15% to +10%, 50 Hz/60 Hz				
	Input Current [Arms] ^{*1}	29	37	54	73	
Control	Power Supply	200 VAC to 240 VAC, -15% to +10%, 50 Hz/60 Hz				
	Input Current [Arms] ^{*1}	0.3	0.3	0.4	0.4	
Power Supply Capacity [kVA] ^{*1}		10.7	14.6	21.7	29.6	
Power Loss ^{*1}	Main Circuit Power Loss [W]	271.7	326.9	365.3	501.4	
	Control Circuit Power Loss [W]	21	21	28	28	
	External Regenerative Resistor Power Loss [W]	180 ^{*2}	350 ^{*3}	350 ^{*3}	350 ^{*3}	
	Total Power Loss [W]	292.7	347.9	393.3	529.4	
Regenerative Resistor	External Regenerative Resistor	Resistance [Ω]	6.25 ^{*2}	3.13 ^{*3}	3.13 ^{*3}	3.13 ^{*3}
		Capacity [W]	880 ^{*2}	1760 ^{*3}	1760 ^{*3}	1760 ^{*3}
	Minimum Allowable External Resistance [Ω]		5.8	2.9	2.9	2.9
Overvoltage Category		III				

*1. This is the net value at the rated load.

*2. This value is for the optional JUSP-RA04-E Regenerative Resistor Unit.

*3. This value is for the optional JUSP-RA05-E Regenerative Resistor Unit.

SERVOPACKs

Σ-7S Single-axis INDEXER Module-Mounted SERVOPACKs

◆ Single-phase, 200 VAC

Model SGD7S-		R70A	R90A	1R6A	2R8A	5R5A	120A
Maximum Applicable Motor Capacity [kW]		0.05	0.1	0.2	0.4	0.75	1.5
Continuous Output Current [Arms]		0.66	0.91	1.6	2.8	5.5	11.6
Instantaneous Maximum Output Current [Arms]		2.1	3.2	5.9	9.3	16.9	28
Main Circuit	Power Supply	200 VAC to 240 VAC, -15% to +10%, 50 Hz/60 Hz					
	Input Current [Arms]*	0.8	1.6	2.4	5.0	8.7	16
Control	Power Supply	200 VAC to 240 VAC, -15% to +10%, 50 Hz/60 Hz					
	Input Current [Arms]*	0.2	0.2	0.2	0.2	0.2	0.25
Power Supply Capacity [kVA]*		0.2	0.3	0.6	1.2	1.9	4.0
Power Loss*	Main Circuit Power Loss [W]	5.0	7.1	12.1	23.7	39.2	71.8
	Control Circuit Power Loss [W]	12	12	12	12	14	16
	Built-in Regenerative Resistor Power Loss [W]	-	-	-	-	8	16
	Total Power Loss [W]	17.0	19.1	24.1	35.7	61.2	103.8
Regenerative Resistor	Built-In Regenerative Resistor	Resistance [Ω]	-	-	-	40	12
		Capacity [W]	-	-	-	40	60
	Minimum Allowable External Resistance [Ω]	40	40	40	40	40	12
Overvoltage Category		III					

* This is the net value at the rated load.

◆ 270 VDC

Model SGD7S-		R70A	R90A	1R6A	2R8A	3R8A	5R5A	7R6A	120A
Maximum Applicable Motor Capacity [kW]		0.05	0.1	0.2	0.4	0.5	0.75	1.0	1.5
Continuous Output Current [Arms]		0.66	0.91	1.6	2.8	3.8	5.5	7.6	11.6
Instantaneous Maximum Output Current [Arms]		2.1	3.2	5.9	9.3	11.0	16.9	17.0	28.0
Main Circuit	Power Supply	270 VDC to 324 VDC, -15% to +10%							
	Input Current [Arms]* ¹	0.5	1.0	1.5	3.0	3.8	4.9	6.9	11
Control	Power Supply	270 VDC to 324 VDC, -15% to +10%							
	Input Current [Arms]* ¹	0.2	0.2	0.2	0.2	0.2	0.2	0.2	0.2 ²
Power Supply Capacity [kVA]* ¹		0.2	0.3	0.6	1	1.4	1.6	2.3	3.2
Power Loss* ¹	Main Circuit Power Loss [W]	4.4	5.9	9.8	17.5	23.0	30.7	38.7	55.8
	Control Circuit Power Loss [W]	12	12	12	12	14	14	14	15
	Total Power Loss [W]	16.4	17.9	21.8	29.5	37.0	44.7	52.7	70.8
Overvoltage Category		III							

*1. This is the net value at the rated load.

*2. The value is 0.25 Arms for the SGD7S-120A00A008.

Model SGD7S-		180A	200A	330A	470A	550A	590A	780A
Maximum Applicable Motor Capacity [kW]		2.0	3.0	5.0	6.0	7.5	11.0	15.0
Continuous Output Current [Arms]		18.5	19.6	32.9	46.9	54.7	58.6	78.0
Instantaneous Maximum Output Current [Arms]		42.0	56.0	84.0	110	130	140	170
Main Circuit	Power Supply	270 VDC to 324 VDC, -15% to +10%						
	Input Current [Arms]*	14	20	34	36	48	68	92
Control	Power Supply	270 VDC to 324 VDC, -15% to +10%						
	Input Current [Arms]*	0.25	0.25	0.3	0.3	0.3	0.4	0.4
Power Supply Capacity [kVA]*		4.0	5.9	7.5	10.7	14.6	21.7	29.6
Power Loss*	Main Circuit Power Loss [W]	82.7	83.5	146.2	211.6	255.3	243.6	343.4
	Control Circuit Power Loss [W]	16	16	19	21	21	28	28
	Total Power Loss [W]	98.7	99.5	165.2	232.6	276.3	271.6	371.4
Overvoltage Category		III						

* This is the net value at the rated load.

◆ Single-phase, 100 VAC

Model SGD7S-		R70F	R90F	2R1F	2R8F
Maximum Applicable Motor Capacity [kW]		0.05	0.1	0.2	0.4
Continuous Output Current [Arms]		0.66	0.91	2.1	2.8
Instantaneous Maximum Output Current [Arms]		2.1	3.2	6.5	9.3
Main Circuit	Power Supply	100 VAC to 120 VAC, -15% to +10%, 50 Hz/60 Hz			
	Input Current [Arms]*	1.5	2.5	5	10
Control	Power Supply	100 VAC to 120 VAC, -15% to +10%, 50 Hz/60 Hz			
	Input Current [Arms]*	0.38	0.38	0.38	0.38
Power Supply Capacity [kVA]*		0.2	0.3	0.6	1.4
Power Loss*	Main Circuit Power Loss [W]	5.3	7.8	14.2	26.2
	Control Circuit Power Loss [W]	12	12	12	12
	Total Power Loss [W]	17.3	19.8	26.2	38.2
Regenerative Resistor	Minimum Allowable External Resistance [Ω]	40	40	40	40
Overvoltage Category		III			

* This is the net value at the rated load.

INDEXER Module Power Loss

The power supply for an INDEXER Module is supplied from the control power supply of the SERVO-PACK. The power loss is given in the following table.

Item	Specification
Power Supply Method	5.05 VDC
Maximum Operating Voltage	5.25 VDC
Maximum Operating Current	500 mA
Maximum Power Loss	2.6 W

SERVOPACK Overload Protection Characteristics

The overload detection level is set for hot start conditions with a SERVOPACK surrounding air temperature of 55°C.

An overload alarm (A.710 or A.720) will occur if overload operation that exceeds the overload protection characteristics shown in the following diagram (i.e., operation on the right side of the applicable line) is performed.

The actual overload detection level will be the detection level of the connected SERVOPACK or Servomotor that has the lower overload protection characteristics.

In most cases, that will be the overload protection characteristics of the Servomotor.

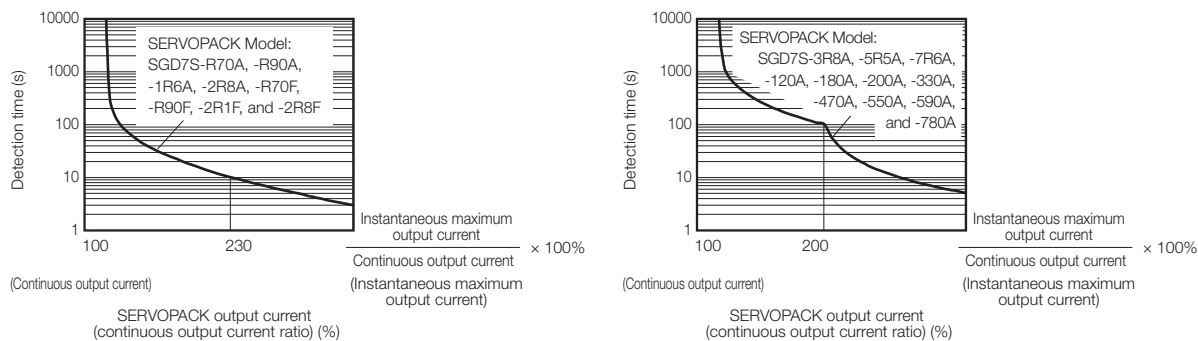

Note: The above overload protection characteristics do not mean that you can perform continuous duty operation with an output of 100% or higher.

For a Yaskawa-specified combination of SERVOPACK and Servomotor, maintain the effective torque (or effective force) within the continuous duty zone of the torque-motor speed characteristic (or force-motor speed characteristics) of the Servomotor.

Specifications

The specifications when the INDEXER Module is combined with a Command Option Attachable-Type SERVOPACK are given in the following table.

Item		Specification	
Control Method		IGBT-based PWM control, sine wave current drive	
Feedback	With Rotary Servomotor	Serial encoder: 17 bits (absolute encoder) 20 bits or 24 bits (incremental encoder/absolute encoder) 22 bits (absolute encoder)	
	With Linear Servomotor	<ul style="list-style-type: none"> Absolute linear encoder (The signal resolution depends on the absolute linear encoder.) Incremental linear encoder (The signal resolution depends on the incremental linear encoder or Serial Converter Unit.) 	
Environmental Conditions	Surrounding Air Temperature	0°C to 55°C	
	Storage Temperature	-20°C to 85°C	
	Surrounding Air Humidity	90% relative humidity max. (with no freezing or condensation)	
	Storage Humidity	90% relative humidity max. (with no freezing or condensation)	
	Vibration Resistance	4.9 m/s ²	
	Shock Resistance	19.6 m/s ²	
	Degree of Protection	Class	SERVOPACK Model: SGD7S-
		IP20	R70A, R90A, 1R6A, 2R8A, 3R8A, 5R5A, 7R6A, 120A, R70F, R90F, 2R1F, 2R8F
		IP10	120AE0A008, 180A, 200A, 330A, 470A, 550A, 590A, 780A
	Pollution Degree	2 <ul style="list-style-type: none"> Must be no corrosive or flammable gases. Must be no exposure to water, oil, or chemicals. Must be no dust, salts, or iron dust. 	
Altitude	1,000 m max.		
Others	Do not use the SERVOPACK in the following locations: Locations subject to static electricity noise, strong electromagnetic/magnetic fields, or radioactivity		
Applicable Standards		UL 61800-5-1 (E147823), CSA C22.2 No.274, EN ISO13849-1: 2015, EN 55011 group 1 class A, EN 61000-6-2, EN 61000-6-4, EN 61800-3 (Category C2, Second environment), EN 50178, EN 61800-5-1, IEC 60204-1, IEC 61508 series, IEC 62061, IEC 61800-5-2, and IEC 61326-3-1	
Mounting	Mounting	SERVOPACK Model: SGD7S-	
	Base-mounted	All Models	
	Rack-mounted	R70A, R90A, 1R6A, 2R8A, 3R8A, 5R5A, 7R6A, 120A, 180A, 200A, 330A, R70F, R90F, 2R1F, 2R8F	
	Duct-ventilated	470A, 550A, 590A, 780A	
Performance	Speed Control Range	1:5000 (At the rated torque, the lower limit of the speed control range must not cause the Servomotor to stop.)	
	Coefficient of Speed Fluctuation* ¹	±0.01% of rated speed max. (for a load fluctuation of 0% to 100%)	
		0% of rated speed max. (for a voltage fluctuation of ±10%)	
		±0.1% of rated speed max. (for a temperature fluctuation of 25°C ±25°C)	
Torque Control Precision (Repeatability)	±1%		
Soft Start Time Setting	0 s to 10 s (Can be set separately for acceleration and deceleration.)		
I/O Signals	Encoder Divided Pulse Output	Phase A, phase B, phase C: Line-driver output Number of divided output pulses: Any setting is allowed.	
	Overheat Protection Input	Number of input points: 1 Input voltage range: 0 V to +5 V	

Continued on next page.

Continued from previous page.



Item		Specification			
I/O Signals	Sequence Input Signals	SERVOPACK	Allowable voltage range: 24 VDC ±20% Number of input points: 6		
			Input method: Sink inputs or source inputs Input Signals: <ul style="list-style-type: none"> • Alarm Reset (/ALM-RST) • Forward Drive Prohibited (P-OT) • Reverse Drive Prohibited (N-OT) • Origin Return Deceleration Switch (/DEC) • Registration (/RGRT) • Servo ON (/S-ON) A signal can be allocated and the positive and negative logic can be changed.		
		INDEXER Module	Fixed Input	Allowable voltage range: 24 VDC ±20% Number of input points: 11	
				/MODE 0/1 (Mode Switch Input) signal	
				Mode 0	Mode 1
				<ul style="list-style-type: none"> • /START-STOP (Program Table Operation Start-Stop Input) signal • /PGMRES (Program Table Operation Reset Input) signal • /SEL0 (Program Step Selection Input 0) signal • /SEL1 (Program Step Selection Input 1) signal • /SEL2 (Program Step Selection Input 2) signal • /SEL3 (Program Step Selection Input 3) signal • /SEL4 (Program Step Selection Input 4) signal • /SEL5 (Program Step Selection Input 5) signal • /SEL6 (Program Step Selection Input 6) signal • /SEL7 (Program Step Selection Input 7) signal 	<ul style="list-style-type: none"> • /HOME (Origin Return Input) signal • /JOGP (Forward Jog Input) signal • /JOGN (Reverse Jog Input) signal • /JOG0 (Jog Speed Table Selection Input 0) signal • /JOG1 (Jog Speed Table Selection Input 1) signal • /JOG2 (Jog Speed Table Selection Input 2) signal • /JOG3 (Jog Speed Table Selection Input 3) signal
	Sequence Output Signals	SERVOPACK	Fixed Output	Allowable voltage range: 5 VDC to 30 VDC Number of output points: 1 Output signal: Servo Alarm (/ALM)	
			Output Signals for Which Allocations Can Be Changed	Allowable voltage range: 5 VDC to 30 VDC Number of output points: 3 (A photocoupler output (isolated) is used.) Output Signals: <ul style="list-style-type: none"> • Warning Output (/WARN) • Brake Output (/BK) • Servo Ready Output (/S-RDY) • Alarm Code Output (/ALO1, /ALO2, and /ALO3) A signal can be allocated and the positive and negative logic can be changed.	
		INDEXER Module	Fixed Output	Allowable voltage range: 5 VDC to 30 VDC Number of output points: 9	
				Output Signals: <ul style="list-style-type: none"> • Positioning Completion Output (/INPOSITION) • Programmable Output 0 (/POUT0) • Programmable Output 1 (/POUT1) • Programmable Output 2 (/POUT2) • Programmable Output 3 (/POUT3) • Programmable Output 4 (/POUT4) • Programmable Output 5 (/POUT5) • Programmable Output 6 (/POUT6) • Programmable Output 7 (/POUT7) 	

Continued on next page.

SERVOPACKs

Σ-7S Single-axis INDEXER Module-Mounted SERVOPACKs

Continued from previous page.

Item		Specification	
Communications	RS-422A Communications (CN3)	Interfaces	Digital Operator (JUSP-OP05A-1-E) and personal computer (with SigmaWin+)
		1:N Communications	Up to N = 15 stations possible for RS-422A port
		Axis Address Setting	Set with parameters.
	USB Communications (CN7)	Interfaces	Interface Personal computer (with SigmaWin+)
Communications Standard		Conforms to USB2.0 standard (12 Mbps).	
Displays/Indicators	SERVOPACK	CHARGE and PWR indicators, and one-digit seven-segment display	
	INDEXER Module	Refer to the following manual for details.  <i>Σ-7-Series AC Servo Drive Σ-7S SERVOPACK Command Option Attachable Type with INDEXER Module Product Manual</i> (Manual No.: SIEP S800001 64)	
Operating Methods	Program Table Method	<ul style="list-style-type: none"> • Program table positioning in which steps are executed sequentially by commands given through contact input or serial communications • Positioning in which station numbers are specified by commands given through contact input or serial communications 	
	Max. Number of Steps	256	
	Max. Number of Tables	256	
	Max. Number of Stations	256	
	Serial Communications Method	Serial command by 1-channel ASCII code Communications specifications: RS-422/485 (50 m max.) Connection topology: Multi-drop connection (16 axes max.) Baud rate: 9600, 19200, 38400 bps	
Other Functions	Registration (positioning by external signals), origin return		
Analog Monitor (CN5)	Number of points: 2 Output voltage range: ±10 VDC (effective linearity range: ±8 V) Resolution: 16 bits Accuracy: ±20 mV (Typ) Maximum output current: ±10 mA Settling time (±1%): 1.2 ms (Typ)		
Dynamic Brake (DB)	Activated when a servo alarm or overtravel (OT) occurs, or when the power supply to the main circuit or servo is OFF.		
Regenerative Processing	Built-in (An external resistor must be connected to the SGD7S-470A to -780A.) Refer to the following section for details.  <i>Built-In Regenerative Resistor</i> (page 472)		
Overtravel (OT) Prevention	Stopping with a dynamic brake (DB), coasting to a stop, performing a hard stop, or performing a smooth stop (decelerating to a stop) for a CCW-OT (CCW Drive Prohibit Input) signal or CW-OT (CW Drive Prohibit Input) signal.		
Protective Functions	Overcurrent, overvoltage, low voltage, overload, regeneration error, etc.		
Utility Functions	Gain adjustment, alarm history, jogging, origin search, etc.		
Safety Functions	Inputs	/HWBB1 and /HWBB2: Base block signals for Power Modules	
	Output	EDM1: Monitors the status of built-in safety circuit (fixed output).	
	Applicable Standards*2	ISO13849-1 PLe (Category 3), IEC61508 SIL3	
Applicable Option Modules	Fully-Closed Module Note: You cannot use a Safety Module if you are using an INDEXER Module.		

*1. The coefficient of speed fluctuation for load fluctuation is defined as follows:

$$\text{Coefficient of speed fluctuation} = \frac{\text{No-load motor speed} - \text{Total-load motor speed}}{\text{Rated motor speed}} \times 100\%$$

*2. Always perform risk assessment for the system and confirm that the safety requirements are met.

Reference Methods

The INDEXER Module has two reference methods: digital I/O and serial commands. These command methods are described in the following sections.

Digital I/O is used with a program table (mode 0) or a jog speed table (mode 1). You can use a program table (mode 0) to execute the program steps that you select with I/O signal patterns (binary format). If the jog speed table (mode 1) is being used, the jog speed selected with the input signal pattern (binary format) can be executed.

- Program Table

PGMSTEP	POS	SPD	RDST	RSPD	ACC*	DEC*	EVENT	LOOP	NEXT
0	I+400000	2000	500000	1000	200	100	T5000	1	1
1	I+100000	1000	200000	2000	100	50	IT0	1	END
⋮	⋮	⋮	⋮	⋮	⋮	⋮	⋮	⋮	⋮
n	I+400000	2000	500000	1000	100	50	IT100	1	n+1
n+1	I+100000	1000	200000	2000	⋮	⋮	NT0	1	END
⋮	⋮	⋮	⋮	⋮	⋮	⋮	⋮	⋮	⋮
254	I+400000	2000	500000	1000	100	50	SEL3T200	1	127
255	I+100000	1000	200000	2000	100	50	DT0	1	END

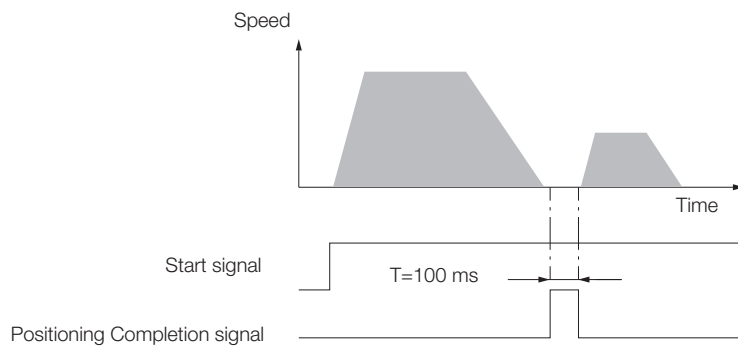

• Jog Speed Table

JSPD	JOG3	JOG2	JOG1	JOG0	Jog Speed
0	0	0	0	0	1000
1	0	0	0	1	2000
2	0	0	1	0	4000
⋮	⋮	⋮	⋮	⋮	⋮
⋮	⋮	⋮	⋮	⋮	⋮
⋮	⋮	⋮	⋮	⋮	⋮
15	1	1	1	1	5500

16 combinations

Note: 1: Signal is ON (active), 0: Signal is OFF (inactive).

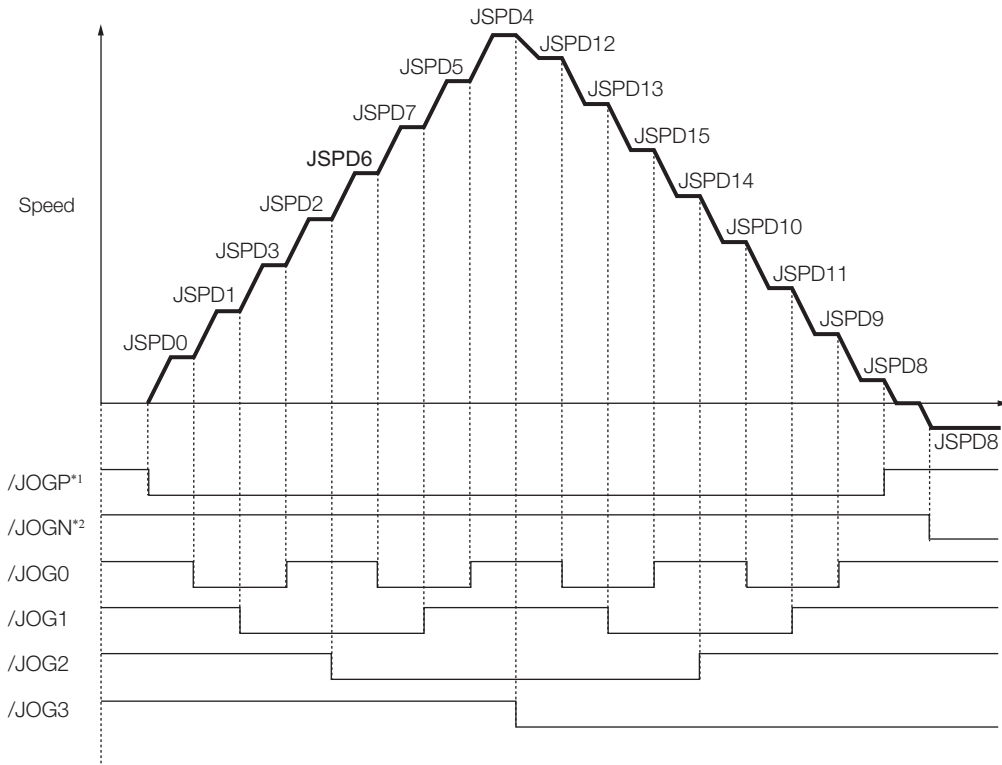

*1. Forward operation at the jog speed is performed while the /JOGP signal is ON.

*2. Reverse operation at the jog speed is performed while the /JOGN signal is ON.

With serial commands, ASCII command strings are sent to the INDEXER Module through RS-422 or RS-485 communications and these commands are interpreted and executed immediately. You can use general-purpose serial communications (RS422/RS485) to perform independent control of up to 16 axes from one host controller (e.g., PC or HMI).

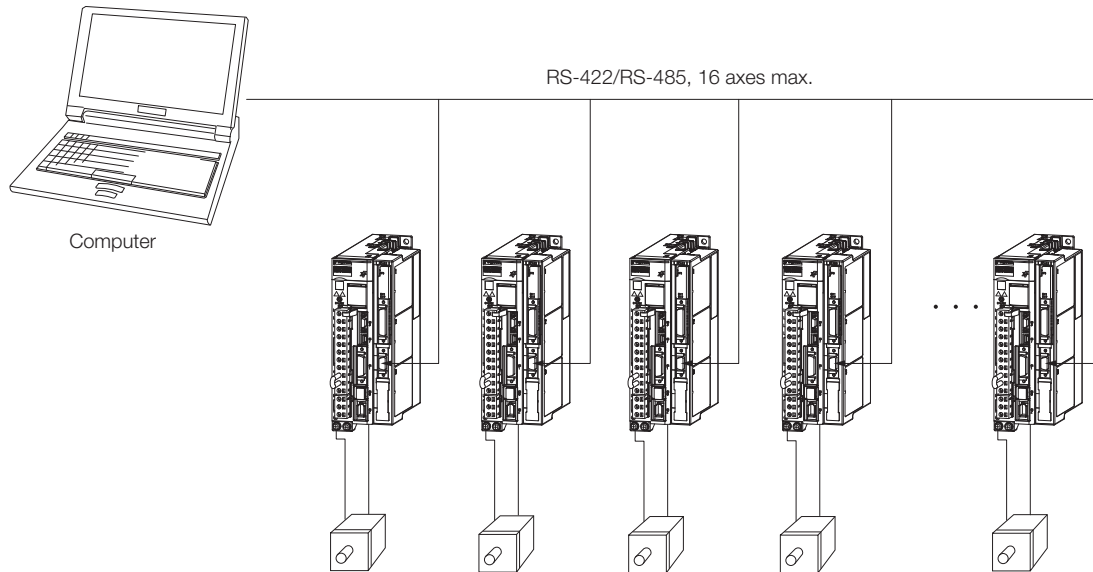

1SVON	# Servo turned ON.
1POS=400000	# Set relative position to 400,000.
1SPD=2000	# Set speed to 2,000.
1ACC=200	# Set acceleration rate to 200.
1DEC=100	# Set deceleration rate to 100.
1ST	# Start operation.
:	

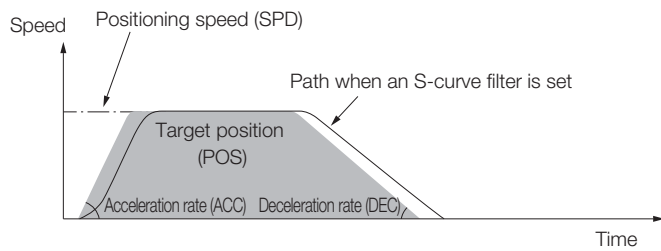

Selecting Cables

◆ System Configurations

■ Σ-7S Single-axis Command Option Attachable-Type SERVOPACKs

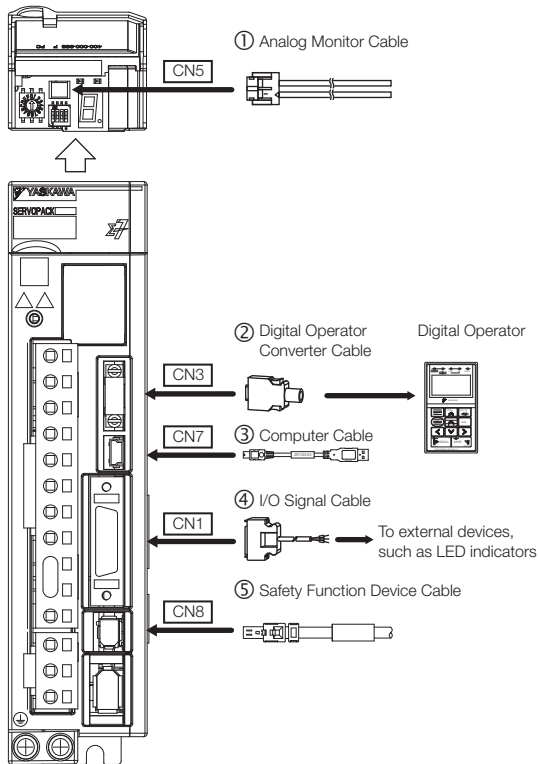

■ Command Option Module: INDEXER Module

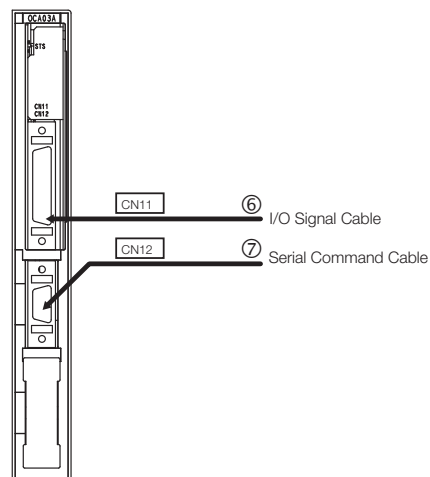

◆ Selection Table



1. Use the cable specified by Yaskawa for the Computer Cable. Operation may not be dependable with any other cable.
2. Use the cable specified by Yaskawa for the MECHATROLINK Communications Cables. Operation may not be dependable due to low noise resistance with any other cable.

Note: Refer to the following manual for the following information.



- Cable dimensional drawings and cable connection specifications
- Order numbers and specifications of individual connectors for cables

📖 *Σ-7-Series AC Servo Drive Peripheral Device Selection Manual (Manual No.: SIEP S800001 32)*

Code	Name	Length (L)	Order Number	Appearance
①	Analog Monitor Cable	1 m	JZSP-CA01-E	
②	Digital Operator Converter Cable	0.3 m	JZSP-CVS05-A3-E*1	
③	Computer Cable	2.5 m	JZSP-CVS06-02-E	

Continued on next page.

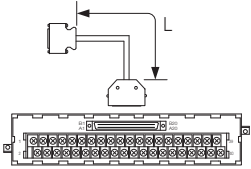
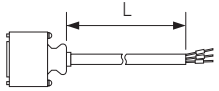
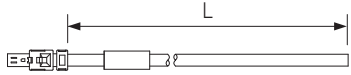
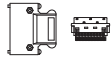
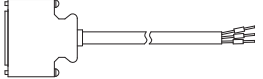
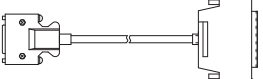
Continued from previous page.

Code	Name	Length (L)	Order Number	Appearance	
④	I/O Signal Cables	Soldered Connector Kit	JZSP-CSI9-2-E		
		Connector-Terminal Block Converter Unit (with cable)	0.5 m	JUSP-TA26P-E	
			1 m	JUSP-TA26P-1-E	
			2 m	JUSP-TA26P-2-E	
		Cable with Loose Wires at One End (loose wires on peripheral device end)	1 m	JZSP-CSI02-1-E	
			2 m	JZSP-CSI02-2-E	
			3 m	JZSP-CSI02-3-E	
⑤	Safety Function Device Cables	Cables with Connectors*2	1 m	JZSP-CVH03-01-E	
			3 m	JZSP-CVH03-03-E	
		Connector Kit*3	Contact Tyco Electronics Japan G.K. Product name: Industrial Mini I/O D-shape Type 1 Plug Connector Kit Model number: 2013595-1		
⑥	I/O Signal Cables	Connector Kit	DP9420007-E		
		Cables with Loose Wires at One End	1 m	JZSP-CVI01-1-E	
			2 m	JZSP-CVI01-2-E	
			3 m	JZSP-CVI01-3-E	
		Cables with Terminal Block on One End	0.5 m	JUSP-TA36V-E	
			1 m	JUSP-TA36V-1-E	
2 m	JUSP-TA36V-2-E				
⑦	Serial Command Cable	Connector Kit*3	JZSP-CHI9-1	Contact Yaskawa Controls Co., Ltd. for the cable. 	

*1. This Converter Cable is required to use the Σ-III-series Digital Operator (JUSP-OP05A) for Σ-7-series SERVOPACKs.

*2. When using safety functions, connect this Cable to the safety function devices.
When not using safety functions, connect the enclosed Safety Jumper Connector (JZSP-CVH05-E) to the SERVOPACK.

*3. Use the Connector Kit when you make cables yourself.

Σ-7S Single-axis DeviceNet Module-Mounted SERVOPACKs

Configuration

A Σ-7S Single-axis DeviceNet Module-Mounted SERVOPACK is a Command Option Attachable-Type SERVOPACK with a DeviceNet Module mounted on the side of the SERVOPACK. Positioning and origin returns can be performed by sending commands from the host controller (DeviceNet master).

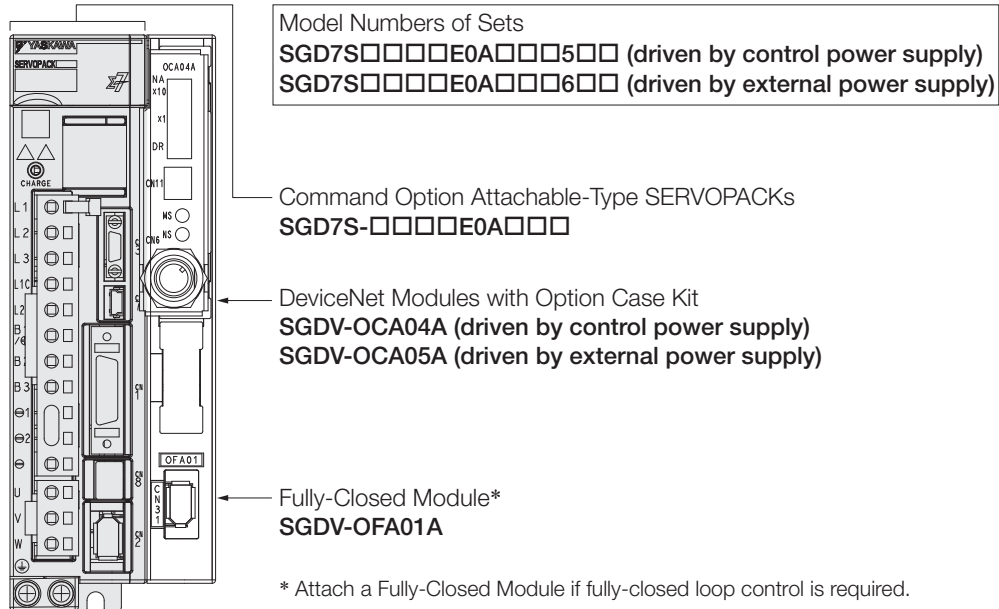

Purchase Order Number

Purchasing a Module in a Set with the SERVOPACK

To order SERVOPACKs with a DeviceNet Module attached, use the following model numbers.

SGD7S *1 R70 A E0 A 000 500

Σ-7 Series Σ-7S SERVOPACKs 1st+2nd+3rd digits 4th digit 5th+6th digits 7th digit 8th+9th+10th digits 11th+12th+13th digits

1st+2nd+3rd digits Maximum Applicable Motor Capacity

Voltage	Code	Specification
Three-phase, 200 VAC	R70 ^{*2}	0.05 kW
	R90 ^{*2}	0.1 kW
	1R6 ^{*2}	0.2 kW
	2R8 ^{*2}	0.4 kW
	3R8	0.5 kW
	5R5 ^{*2}	0.75 kW
	7R6	1.0 kW
	120 ^{*3}	1.5 kW
	180	2.0 kW
	200 ^{*4}	3.0 kW
	330	5.0 kW
	470	6.0 kW
550	7.5 kW	
590	11 kW	
780	15 kW	
Single-phase, 100 VAC	R70	0.05 kW
	R90	0.1 kW
	2R1	0.2 kW
	2R8	0.4 kW

4th digit Voltage

Code	Specification
A	200 VAC
F	100 VAC

5th+6th digits Interface

Code	Specification
E0	Command Option Attachable Type

7th digit Design Revision Order

A

8th+9th+10th digits Hardware Options Specification

Code	Specification	Applicable Models
None	Without options	All models
001	Rack-mounted	SGD7S-R70A to -330A SGD7S-R70F to -2R8F
	Duct-ventilated	SGD7S-470A to -780A
002	Varnished	All models
008	Single-phase, 200-VAC power supply input	SGD7S-120A
020 ^{*5}	No dynamic brake	SGD7S-R70A to -2R8A SGD7S-R70F to -2R8F
		External dynamic brake resistor

11th+12th+13th digits Option Module

Code	Specification
500	DeviceNet Module driven by control power supply
501	DeviceNet Module driven by control power supply +Fully-Closed Module
600	DeviceNet Module driven by external power supply
601	DeviceNet Module driven by external power supply +Fully-Closed Module

- *1. The model number of a SERVOPACK with an Option Module is not hyphenated after SGD7S.
- *2. You can use these models with either a single-phase or three-phase power supply input.
- *3. A model with a single-phase, 200-VAC power supply input is available as a hardware option (model: SGD7S-120AE0A008).
- *4. The rated output is 2.4 kW if you combine the SGM7G-30A with the SGD7S-200A.
- *5. Refer to the following manual for details.

📖 Σ-7-Series AC Servo Drive Σ-7S/Σ-7W SERVOPACK with Hardware Option Specifications Dynamic Brake Product Manual (Manual No.: SIEP S800001 73)

Note: Contact your Yaskawa representative for information on combining options.

The DeviceNet Module is equipped with an Option Case Kit. (Option Case Kits do not need to be ordered separately.)

Purchasing a Module Separately

When ordering SERVOPACKs and Option Modules separately, use the following model numbers.

◆ SERVOPACK

SGD7S - R70 A E0 A 001 000 B

Σ-7 Series Σ-7S SERVOPACKs 1st+2nd+3rd digits 4th digit 5th+6th digits 7th digit 8th+9th+10th digits 11th+12th+13th digits 14th digit

1st+2nd+3rd digits Maximum Applicable Motor Capacity

Voltage	Code	Specification
Three-phase, 200 VAC	R70*1	0.05 kW
	R90*1	0.1 kW
	1R6*1	0.2 kW
	2R8*1	0.4 kW
	3R8	0.5 kW
	5R5*1	0.75 kW
	7R6	1.0 kW
	120*2	1.5 kW
	180	2.0 kW
	200*3	3.0 kW
	330	5.0 kW
	470	6.0 kW
	550	7.5 kW
590	11 kW	
780	15 kW	
Single-phase, 100 VAC	R70	0.05 kW
	R90	0.1 kW
	2R1	0.2 kW
	2R8	0.4 kW

4th digit Voltage

Code	Specification
A	200 VAC
F	100 VAC

5th+6th digits Interface*4

Code	Specification
E0	Command Option Attachable Type

7th digit Design Revision Order

A

8th+9th+10th digits Hardware Options Specification

Code	Specification	Applicable Models
None 000	Without options	All models
001	Rack-mounted	SGD7S-R70A to -330A SGD7S-R70F to -2R8F
	Duct-ventilated	SGD7S-470A to -780A
002	Varnished	All models
008	Single-phase, 200-VAC power supply input	SGD7S-120A
020*5	No dynamic brake	SGD7S-R70A to -2R8A SGD7S-R70F to -2R8F
	External dynamic brake resistor	SGD7S-3R8A to -780A

11th+12th+13th digits FT/EX Specification

Code	Specification
None 000	None

14th digit BTO Specification*6

Code	Specification
None	None
B	BTO Specification

*1. You can use these models with either a single-phase or three-phase power supply input.

*2. A model with a single-phase, 200-VAC power supply input is available as a hardware option (model: SGD7S-120AE0A008).

*3. The rated output is 2.4 kW if you combine the SGM7G-30A with the SGD7S-200A.

*4. The same SERVOPACKs are used for both Rotary Servomotors and Linear Servomotors.

*5. Refer to the following manual for details.

 Σ-7-Series AC Servo Drive Σ-7S/Σ-7W SERVOPACK with Hardware Option Specifications Dynamic Brake Product Manual (Manual No.: S1EP S800001 73)

*6. The BTO specification indicates if the SERVOPACK is customized by using the MechatroCloud BTO service.

You need a BTO number to order SERVOPACKs with customized specifications.

Refer to page M-15 for the details on the BTO service.

◆ DeviceNet Modules

SGDV-OCA04A (driven by control power supply)

SGDV-OCA05A (driven by external power supply)



Important

The DeviceNet Module is equipped with an Option Case Kit. (Option Case Kits do not need to be ordered separately.)

◆ Fully-Closed Module

SGDV-OFA01A

Ratings and Specifications

SERVOPACK Ratings

◆ Three-Phase, 200 VAC

Model SGD7S-		R70A	R90A	1R6A	2R8A	3R8A	5R5A	7R6A	120A	180A	200A	330A	
Maximum Applicable Motor Capacity [kW]		0.05	0.1	0.2	0.4	0.5	0.75	1.0	1.5	2.0	3.0	5.0	
Continuous Output Current [Arms]		0.66	0.91	1.6	2.8	3.8	5.5	7.6	11.6	18.5	19.6	32.9	
Instantaneous Maximum Output Current [Arms]		2.1	3.2	5.9	9.3	11	16.9	17	28	42	56	84.0	
Main Circuit	Power Supply	200 VAC to 240 VAC, -15% to +10%, 50 Hz/60 Hz											
	Input Current [Arms]*	0.4	0.8	1.3	2.5	3.0	4.1	5.7	7.3	10	15	25	
Control	Power Supply	200 VAC to 240 VAC, -15% to +10%, 50 Hz/60 Hz											
	Input Current [Arms]*	0.2	0.2	0.2	0.2	0.2	0.2	0.2	0.2	0.25	0.25	0.3	
Power Supply Capacity [kVA]*		0.2	0.3	0.5	1.0	1.3	1.6	2.3	3.2	4.0	5.9	7.5	
Power Loss*	Main Circuit Power Loss [W]	5.0	7.0	11.9	22.5	28.5	38.9	49.2	72.6	104.2	114.2	226.6	
	Control Circuit Power Loss [W]	12	12	12	12	14	14	14	15	16	16	19	
	Built-in Regenerative Resistor Power Loss [W]	-	-	-	-	8	8	8	10	16	16	36	
	Total Power Loss [W]	17.0	19.0	23.9	34.5	50.5	60.9	71.2	97.6	136.2	146.2	281.6	
Regenerative Resistor	Built-In Regenerative Resistor	Resistance [Ω]	-	-	-	-	40	40	40	20	12	12	8
		Capacity [W]	-	-	-	-	40	40	40	60	60	60	180
	Minimum Allowable External Resistance [Ω]		40	40	40	40	40	40	40	20	12	12	8
Overvoltage Category		III											

* This is the net value at the rated load.

Model SGD7S-		470A	550A	590A	780A	
Maximum Applicable Motor Capacity [kW]		6.0	7.5	11	15	
Continuous Output Current [Arms]		46.9	54.7	58.6	78.0	
Instantaneous Maximum Output Current [Arms]		110	130	140	170	
Main Circuit	Power Supply	200 VAC to 240 VAC, -15% to +10%, 50 Hz/60 Hz				
	Input Current [Arms]* ¹	29	37	54	73	
Control	Power Supply	200 VAC to 240 VAC, -15% to +10%, 50 Hz/60 Hz				
	Input Current [Arms]* ¹	0.3	0.3	0.4	0.4	
Power Supply Capacity [kVA]* ¹		10.7	14.6	21.7	29.6	
Power Loss* ¹	Main Circuit Power Loss [W]	271.7	326.9	365.3	501.4	
	Control Circuit Power Loss [W]	21	21	28	28	
	External Regenerative Resistor Power Loss [W]	180* ²	350* ³	350* ³	350* ³	
	Total Power Loss [W]	292.7	347.9	393.3	529.4	
Regenerative Resistor	External Regenerative Resistor	Resistance [Ω]	6.25* ²	3.13* ³	3.13* ³	3.13* ³
		Capacity [W]	880* ²	1760* ³	1760* ³	1760* ³
	Minimum Allowable External Resistance [Ω]		5.8	2.9	2.9	2.9
Overvoltage Category		III				

*1. This is the net value at the rated load.

*2. This value is for the optional JUSP-RA04-E Regenerative Resistor Unit.

*3. This value is for the optional JUSP-RA05-E Regenerative Resistor Unit.

SERVOPACKs

Σ-7S Single-axis DeviceNet Module-Mounted SERVOPACKs

◆ Single-phase, 200 VAC

Model SGD7S-		R70A	R90A	1R6A	2R8A	5R5A	120A
Maximum Applicable Motor Capacity [kW]		0.05	0.1	0.2	0.4	0.75	1.5
Continuous Output Current [Arms]		0.66	0.91	1.6	2.8	5.5	11.6
Instantaneous Maximum Output Current [Arms]		2.1	3.2	5.9	9.3	16.9	28
Main Circuit	Power Supply	200 VAC to 240 VAC, -15% to +10%, 50 Hz/60 Hz					
	Input Current [Arms]*	0.8	1.6	2.4	5.0	8.7	16
Control	Power Supply	200 VAC to 240 VAC, -15% to +10%, 50 Hz/60 Hz					
	Input Current [Arms]*	0.2	0.2	0.2	0.2	0.2	0.25
Power Supply Capacity [kVA]*		0.2	0.3	0.6	1.2	1.9	4.0
Power Loss*	Main Circuit Power Loss [W]	5.0	7.1	12.1	23.7	39.2	71.8
	Control Circuit Power Loss [W]	12	12	12	12	14	16
	Built-in Regenerative Resistor Power Loss [W]	–	–	–	–	8	16
	Total Power Loss [W]	17.0	19.1	24.1	35.7	61.2	103.8
Regenerative Resistor	Built-In Regenerative Resistor	Resistance [Ω]	–	–	–	40	12
		Capacity [W]	–	–	–	40	60
	Minimum Allowable External Resistance [Ω]	40	40	40	40	40	12
Overvoltage Category		III					

* This is the net value at the rated load.

◆ 270 VDC

Model SGD7S-		R70A	R90A	1R6A	2R8A	3R8A	5R5A	7R6A	120A
Maximum Applicable Motor Capacity [kW]		0.05	0.1	0.2	0.4	0.5	0.75	1.0	1.5
Continuous Output Current [Arms]		0.66	0.91	1.6	2.8	3.8	5.5	7.6	11.6
Instantaneous Maximum Output Current [Arms]		2.1	3.2	5.9	9.3	11.0	16.9	17.0	28.0
Main Circuit	Power Supply	270 VDC to 324 VDC, -15% to +10%							
	Input Current [Arms]* ¹	0.5	1.0	1.5	3.0	3.8	4.9	6.9	11
Control	Power Supply	270 VDC to 324 VDC, -15% to +10%							
	Input Current [Arms]* ¹	0.2	0.2	0.2	0.2	0.2	0.2	0.2	0.2 ²
Power Supply Capacity [kVA]* ¹		0.2	0.3	0.6	1	1.4	1.6	2.3	3.2
Power Loss* ¹	Main Circuit Power Loss [W]	4.4	5.9	9.8	17.5	23.0	30.7	38.7	55.8
	Control Circuit Power Loss [W]	12	12	12	12	14	14	14	15
	Total Power Loss [W]	16.4	17.9	21.8	29.5	37.0	44.7	52.7	70.8
Overvoltage Category		III							

*1. This is the net value at the rated load.

*2. The value is 0.25 Arms for the SGD7S-120A00A008.

Model SGD7S-		180A	200A	330A	470A	550A	590A	780A
Maximum Applicable Motor Capacity [kW]		2.0	3.0	5.0	6.0	7.5	11.0	15.0
Continuous Output Current [Arms]		18.5	19.6	32.9	46.9	54.7	58.6	78.0
Instantaneous Maximum Output Current [Arms]		42.0	56.0	84.0	110	130	140	170
Main Circuit	Power Supply	270 VDC to 324 VDC, -15% to +10%						
	Input Current [Arms]*	14	20	34	36	48	68	92
Control	Power Supply	270 VDC to 324 VDC, -15% to +10%						
	Input Current [Arms]*	0.25	0.25	0.3	0.3	0.3	0.4	0.4
Power Supply Capacity [kVA]*		4.0	5.9	7.5	10.7	14.6	21.7	29.6
Power Loss*	Main Circuit Power Loss [W]	82.7	83.5	146.2	211.6	255.3	243.6	343.4
	Control Circuit Power Loss [W]	16	16	19	21	21	28	28
	Total Power Loss [W]	98.7	99.5	165.2	232.6	276.3	271.6	371.4
Overvoltage Category		III						

* This is the net value at the rated load.

◆ Single-phase, 100 VAC

Model SGD7S-		R70F	R90F	2R1F	2R8F
Maximum Applicable Motor Capacity [kW]		0.05	0.1	0.2	0.4
Continuous Output Current [Arms]		0.66	0.91	2.1	2.8
Instantaneous Maximum Output Current [Arms]		2.1	3.2	6.5	9.3
Main Circuit	Power Supply	100 VAC to 120 VAC, -15% to +10%, 50 Hz/60 Hz			
	Input Current [Arms]*	1.5	2.5	5	10
Control	Power Supply	100 VAC to 120 VAC, -15% to +10%, 50 Hz/60 Hz			
	Input Current [Arms]*	0.38	0.38	0.38	0.38
Power Supply Capacity [kVA]*		0.2	0.3	0.6	1.4
Power Loss*	Main Circuit Power Loss [W]	5.3	7.8	14.2	26.2
	Control Circuit Power Loss [W]	12	12	12	12
	Total Power Loss [W]	17.3	19.8	26.2	38.2
Regenerative Resistor	Minimum Allowable External Resistance [Ω]	40	40	40	40
Overvoltage Category		III			

* This is the net value at the rated load.

DeviceNet Module Ratings

The power supply method and power loss of a DeviceNet Module depend on the model of the DeviceNet Module.

◆ SGDV-OCA04A (Interface: Driven by Control Power Supply)

The specifications of the SGDV-OCA04A DeviceNet Module are given in the following table.

Item	Specification	
	DeviceNet Communications Section	Control Section
Power Supply Method	Supplied from the DeviceNet communications cable.	Supplied from the control power supply of a Command Option Attachable-Type SERVOPACK.
Minimum Operating Voltage	11 VDC	Included in the current consumption of the Command Option Attachable-Type SERVOPACK.
Maximum Operating Voltage	25 VDC	
Maximum Operating Current	25 mA	
Maximum Power Loss	625 mW	

◆ SGDV-OCA05A (Interface: Driven by External Power Supply)

The specifications of the SGDV-OCA05A DeviceNet Module are given in the following table.

Item	Specification	
	DeviceNet Communications Section	Control Section
Power Supply Method	Supplied from the DeviceNet communications cable.	
Minimum Operating Voltage	11 VDC	
Maximum Operating Voltage	25 VDC	
Maximum Operating Current	100 mA for 24-VDC power supply 200 mA for 11-VDC power supply	
Maximum Power Loss	2.4 W	

SERVOPACK Overload Protection Characteristics

The overload detection level is set for hot start conditions with a SERVOPACK surrounding air temperature of 55°C.

An overload alarm (A.710 or A.720) will occur if overload operation that exceeds the overload protection characteristics shown in the following diagram (i.e., operation on the right side of the applicable line) is performed.

The actual overload detection level will be the detection level of the connected SERVOPACK or Servomotor that has the lower overload protection characteristics.

In most cases, that will be the overload protection characteristics of the Servomotor.

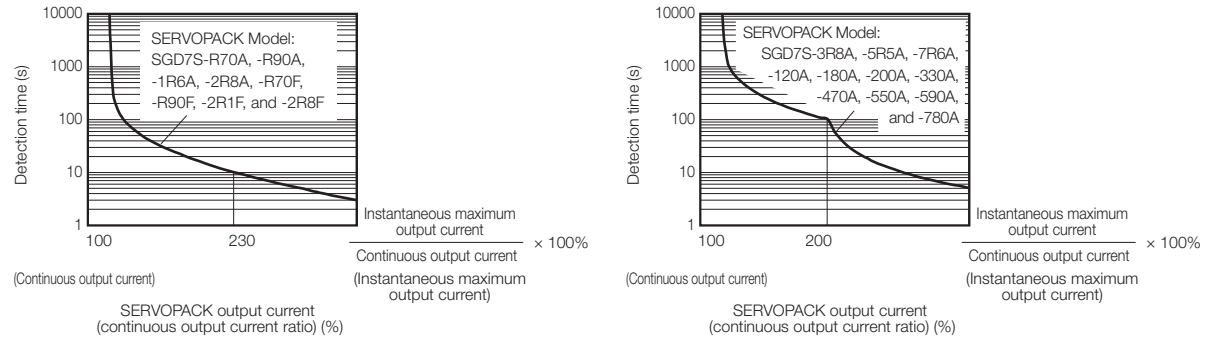

Note: The above overload protection characteristics do not mean that you can perform continuous duty operation with an output of 100% or higher.

For a Yaskawa-specified combination of SERVOPACK and Servomotor, maintain the effective torque (or effective force) within the continuous duty zone of the torque-motor speed characteristic (or force-motor speed characteristics) of the Servomotor.

Specifications

The specifications when the DeviceNet Module is combined with a Command Option Attachable-Type SERVOPACK are given in the following table.



Item		Specification								
Control Method		IGBT-based PWM control, sine wave current drive								
Feedback	With Rotary Servomotor	Serial encoder: 17 bits (absolute encoder) 20 bits or 24 bits (incremental encoder/absolute encoder) 22 bits (absolute encoder)								
	With Linear Servomotor	<ul style="list-style-type: none"> Absolute linear encoder (The signal resolution depends on the absolute linear encoder.) Incremental linear encoder (The signal resolution depends on the incremental linear encoder or Serial Converter Unit.) 								
Surrounding Air Temperature		0°C to 55°C								
Storage Temperature		-20°C to 85°C								
Surrounding Air Humidity		90% relative humidity max. (with no freezing or condensation)								
Storage Humidity		90% relative humidity max. (with no freezing or condensation)								
Vibration Resistance		4.9 m/s ²								
Shock Resistance		19.6 m/s ²								
Environmental Conditions	Degree of Protection	<table border="1"> <thead> <tr> <th>Class</th> <th>SERVOPACK Model: SGD7S-</th> </tr> </thead> <tbody> <tr> <td>IP20</td> <td>R70A, R90A, 1R6A, 2R8A, 3R8A, 5R5A, 7R6A, 120A, R70F, R90F, 2R1F, 2R8F</td> </tr> <tr> <td>IP10</td> <td>120AE0A008, 180A, 200A, 330A, 470A, 550A, 590A, 780A</td> </tr> </tbody> </table>	Class	SERVOPACK Model: SGD7S-	IP20	R70A, R90A, 1R6A, 2R8A, 3R8A, 5R5A, 7R6A, 120A, R70F, R90F, 2R1F, 2R8F	IP10	120AE0A008, 180A, 200A, 330A, 470A, 550A, 590A, 780A		
		Class	SERVOPACK Model: SGD7S-							
		IP20	R70A, R90A, 1R6A, 2R8A, 3R8A, 5R5A, 7R6A, 120A, R70F, R90F, 2R1F, 2R8F							
	IP10	120AE0A008, 180A, 200A, 330A, 470A, 550A, 590A, 780A								
	Pollution Degree	2 <ul style="list-style-type: none"> Must be no corrosive or flammable gases. Must be no exposure to water, oil, or chemicals. Must be no dust, salts, or iron dust. 								
	Altitude	1,000 m max.								
Others	Do not use the SERVOPACK in the following locations: Locations subject to static electricity noise, strong electromagnetic/magnetic fields, or radioactivity									
Applicable Standards		UL 61800-5-1 (E147823), CSA C22.2 No.274, EN ISO13849-1: 2015, EN 55011 group 1 class A, EN 61000-6-2, EN 61000-6-4, EN 61800-3 (Category C2, Second environment), EN 50178, EN 61800-5-1, IEC 60204-1, IEC 61508 series, IEC 62061, IEC 61800-5-2, and IEC 61326-3-1								
Mounting	<table border="1"> <thead> <tr> <th>Mounting</th> <th>SERVOPACK Model: SGD7S-</th> </tr> </thead> <tbody> <tr> <td>Base-mounted</td> <td>All Models</td> </tr> <tr> <td>Rack-mounted</td> <td>R70A, R90A, 1R6A, 2R8A, 3R8A, 5R5A, 7R6A, 120A, 180A, 200A, 330A, R70F, R90F, 2R1F, 2R8F</td> </tr> <tr> <td>Duct-ventilated</td> <td>470A, 550A, 590A, 780A</td> </tr> </tbody> </table>		Mounting	SERVOPACK Model: SGD7S-	Base-mounted	All Models	Rack-mounted	R70A, R90A, 1R6A, 2R8A, 3R8A, 5R5A, 7R6A, 120A, 180A, 200A, 330A, R70F, R90F, 2R1F, 2R8F	Duct-ventilated	470A, 550A, 590A, 780A
	Mounting	SERVOPACK Model: SGD7S-								
	Base-mounted	All Models								
	Rack-mounted	R70A, R90A, 1R6A, 2R8A, 3R8A, 5R5A, 7R6A, 120A, 180A, 200A, 330A, R70F, R90F, 2R1F, 2R8F								
Duct-ventilated	470A, 550A, 590A, 780A									
Speed Control Range	1:5000 (At the rated torque, the lower limit of the speed control range must not cause the Servomotor to stop.)									
Coefficient of Speed Fluctuation* ¹	±0.01% of rated speed max. (for a load fluctuation of 0% to 100%)									
	0% of rated speed max. (for a voltage fluctuation of ±10%)									
	±0.1% of rated speed max. (for a temperature fluctuation of 25°C ±25°C)									
Torque Control Precision (Repeatability)	±1%									
Soft Start Time Setting	0 s to 10 s (Can be set separately for acceleration and deceleration.)									
I/O Signals	Encoder Divided Pulse Output	Phase A, phase B, phase C: Line-driver output Number of divided output pulses: Any setting is allowed.								
	Overheat Protection Input	Number of input points: 1 Input voltage range: 0 V to +5 V								

Continued on next page.

SERVOPACKs

Σ-7S Single-axis DeviceNet Module-Mounted SERVOPACKs

Continued from previous page.

Item		Specification	
I/O Signals	Sequence Input Signals	Allowable voltage range: 24 VDC ±20% Number of input points: 4 Input method: Sink inputs or source inputs Input Signals <ul style="list-style-type: none"> • CCW-OT (CCW Drive Prohibit Input) signal • CW-OT (CW Drive Prohibit Input) signal • /HOME (Origin Signal Input) signal • EXSTOP (External Stop Input) Signal Positive or negative logic can be changed in the parameters.	
	Sequence Output Signals	Allowable voltage range: 5 VDC to 30 VDC Number of output points: 4 Output Signals <ul style="list-style-type: none"> • ALM (Servo Alarm Output) signal • /WARN (Warning Signal Output) signal • /BK (Brake) signal • /S-RDY (Servo Ready Output) signal 	
Communications	Digital Operator Communications (CN3)	Interfaces	Digital Operator (JUSP-OP05A-1-E)
	USB Communications (CN7)	Interface	Personal computer (with SigmaWin+)
Communications Standard			Conforms to USB2.0 standard (12 Mbps).
Displays/Indicators	SERVOPACK		CHARGE and PWR indicators, and one-digit seven-segment display
	DeviceNet Module		Refer to the following manual for details.  <i>Σ-7-Series AC Servo Drive Σ-7S SERVOPACK Command Option Attachable Type with DeviceNet Module Product Manual (Manual No.: SIEP S800001 70)</i>
Operating Methods	Reference Method	Operation Specifications	Positioning via DeviceNet communications.
		Reference Inputs	DeviceNet communications Commands: Movement references (positioning or speed) and origin returns
	Position Control Functions	Acceleration/Deceleration Methods	Linear, asymmetrical, exponential, and S-curve acceleration/deceleration
		Operating Methods	Simple positioning, origin returns, continuous operation, and switching to positioning
		Fully-Closed Loop Control	Supported.
	Built-in Functions	Position Data Latching	Position data can be latched on phase C, the origin signal, or an external signal.
	DeviceNet Communications	Communications Methods	DeviceNet I/O communications and explicit messages
		Topology	Multidrop or T-branching*2
Baud Rate		125 kbps, 250 kbps, or 500 kbps (Set on rotary switch (DR).)	
Cables		Special cables (OMRON DCA1-5CN02F1 Cable with Connectors or the equivalent.)	
Maximum Number of Nodes		64 nodes (including the master, Maximum number of slaves: 63)	
Node Address Setting	0 to 63 (Set on NA x10 and x1 rotary switches.)		
Analog Monitor (CN5)		Number of points: 2 Output voltage range: ±10 VDC (effective linearity range: ±8 V) Resolution: 16 bits Accuracy: ±20 mV (Typ) Maximum output current: ±10 mA Settling time (±1%): 1.2 ms (Typ)	
Dynamic Brake (DB)		Activated when a servo alarm or overtravel (OT) occurs, or when the power supply to the main circuit or servo is OFF.	
Regenerative Processing		Built-in (An external resistor must be connected to the SGD7S-470A to -780A.) Refer to the following section for details.  Built-In Regenerative Resistor (page 472)	

Continued on next page.

Continued from previous page.

Item		Specification
Overtravel (OT) Prevention		Stopping with a dynamic brake (DB), coasting to a stop, performing a hard stop, or smooth stop (decelerating to a stop) for a CCW-OT (CCW Drive Prohibit Input) signal or CW-OT (CW Drive Prohibit Input) signal.
Protective Functions		Overcurrent, overvoltage, low voltage, overload, regeneration error, etc.
Utility Functions		Gain adjustment, alarm history, jogging, origin search, etc.
Safety Functions	Inputs	/HWBB1 and /HWBB2: Base block signals for Power Modules
	Output	EDM1: Monitors the status of built-in safety circuit (fixed output).
	Applicable Standards* ³	ISO13849-1 PLe (Category 3), IEC61508 SIL3
Applicable Option Modules		Fully-Closed Module Note: You cannot use a Safety Module if you are using a DeviceNet Module.

*1. The coefficient of speed fluctuation for load fluctuation is defined as follows:

$$\text{Coefficient of speed fluctuation} = \frac{\text{No-load motor speed} - \text{Total-load motor speed}}{\text{Rated motor speed}} \times 100\%$$

*2. Externally connected terminating resistance is required.

*3. Always perform risk assessment for the system and confirm that the safety requirements are met.

The following table gives the specifications of the DeviceNet Module.

Item		Specification	
		SGDV-OCA04A	SGDV-OCA05A
Mounting Location		Mounted to the side of a Command Option Attachable-Type SERVOPACK.	
Power Supply Method	Control Section	Supplied from the control power supply of a Command Option Attachable-Type SERVOPACK.	Supplied from the DeviceNet communications cable.
	DeviceNet Communications Section	Supplied from the DeviceNet communications cable.	
Current Consumption	Control Section	Included in the current consumption of the Command Option Attachable-Type SERVOPACK.	For 24-VDC power supply: 100 mA max., for 11-VDC power supply: 200 mA max.
	DeviceNet Communications Section	25 mA max.	

Selecting Cables

◆ System Configurations

■ Σ-7S Single-axis Command Option Attachable-Type SERVOPACKs

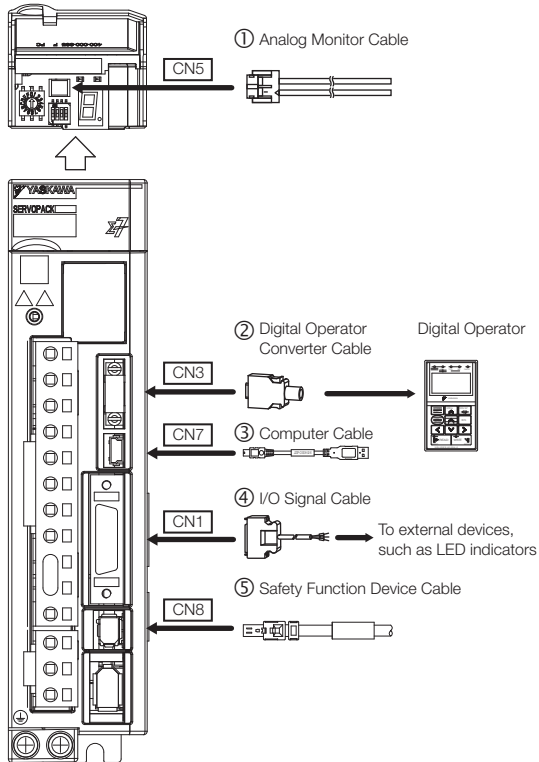

■ Command Option Module: DeviceNet Module

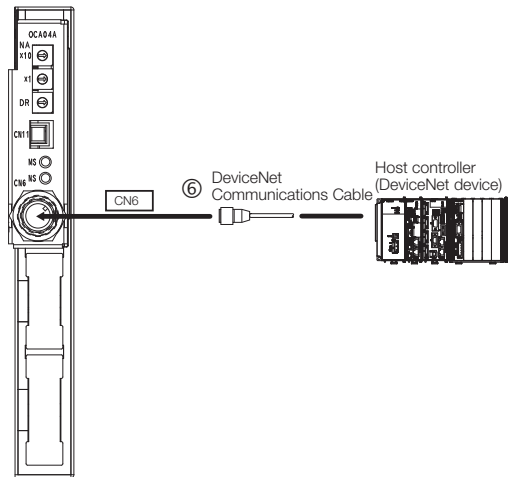

◆ Selection Table



1. Use the cable specified by Yaskawa for the Computer Cable. Operation may not be depend-able with any other cable.
2. Use the cable specified by Yaskawa for the MECHATROLINK Communications Cables. Opera-tion may not be dependable due to low noise resistance with any other cable.

Note: Refer to the following manual for the following information.

- Cable dimensional drawings and cable connection specifications
- Order numbers and specifications of individual connectors for cables

📖 *Σ-7-Series AC Servo Drive Peripheral Device Selection Manual (Manual No.: SIEP S800001 32)*

Code	Name	Length (L)	Order Number	Appearance	
①	Analog Monitor Cable	1 m	JZSP-CA01-E		
②	Digital Operator Converter Cable	0.3 m	JZSP-CVS05-A3-E*1		
③	Computer Cable	2.5 m	JZSP-CVS06-02-E		
④	I/O Signal Cables	Soldered Connector Kit	JZSP-CSI9-2-E		
		Connector-Terminal Block Converter Unit (with cable)	0.5 m	JUSP-TA26P-E	
			1 m	JUSP-TA26P-1-E	
			2 m	JUSP-TA26P-2-E	
		Cable with Loose Wires at One End (loose wires on peripheral device end)	1 m	JZSP-CSI02-1-E	
			2 m	JZSP-CSI02-2-E	
3 m	JZSP-CSI02-3-E				
⑤	Safety Function Device Cables	Cables with Connectors*2	1 m	JZSP-CVH03-01-E	
			3 m	JZSP-CVH03-03-E	
		Connector Kit*3	Contact Tyco Electronics Japan G.K. Product name: Industrial Mini I/O D-shape Type 1 Plug Connector Kit Model number: 2013595-1		
⑥	DeviceNet Communications Cable		The communications cable must be an ODVA-Compliant DeviceNet communications cable. We recommend the following Cable. OMRON DCA1-5CN02F1 Cable with Connectors or the equivalent.		

*1. This Converter Cable is required to use the Σ-III-series Digital Operator (JUSP-OP05A) for Σ-7-series SERVOPACKs.

*2. When using safety functions, connect this Cable to the safety function devices.
When not using safety functions, connect the enclosed Safety Jumper Connector (JZSP-CVH05-E) to the SERVOPACK.

*3. Use the Connector Kit when you make cables yourself.

Σ-7S Single-axis FT82 SERVOPACKs

SGM7D Motor Drive

Model Designations

SGD7S - 2R8 A 00 A 001 F82 B

Σ-7 Series
Σ-7S SERVOPACKs

1st+2nd+3rd digits

4th digit

5th+6th digits

7th digit

8th+9th+10th digits

11th+12th+13th digits

14th digit

1st+2nd+3rd digits Maximum Applicable Motor Capacity

Voltage	Code	Specification
Three-phase, 200 VAC	2R8*1	0.4 kW
	120*2	1.5 kW
Single-phase, 100 VAC	2R8	0.4 kW

4th digit Voltage

Code	Specification
A	200 VAC
F	100 VAC

5th+6th digits Interface

Code	Specification
00	Analog voltage/pulse train reference
10	MECHATROLINK-II communications reference
20	MECHATROLINK-III communications reference
E0	Command Option Attachable Type*3

7th digit Design Revision Order

A

8th+9th+10th digits Hardware Options Specification

Code	Specification	Applicable Models
None	Without options	All models
000		
001	Rack-mounted	All models
002	Varnished	All models
008	Single-phase, 200-VAC power supply input	SGD7S-120A
020*4	No dynamic brake	SGD7S-2R8A SGD7S-2R8F
	External dynamic brake resistor	SGD7S-120A

11th+12th+13th digits FT/EX Specification

Code	Specification
F82*5	Application function option for special motors, SGM7D motor drive

14th digit BTO Specification*6 (Available in Japan only)

Code	Specification
None	None
B	BTO Specification

*1. You can use these models with either a single-phase or three-phase power supply input.

*2. A model with a single-phase, 200-VAC power supply input is available as a hardware option (model: SGD7S-120A□0A008).

*3. This interface is supported only by an INDEXER Module (model: SGD7S-OCA03A).

*4. Refer to the following manual for details.

📖 *Σ-7-Series AC Servo Drive Σ-7S/Σ-7W SERVOPACK with Hardware Option Specifications Dynamic Brake Product Manual* (Manual No.: SIEP S800001 73)

*5. Refer to the following manual for details.

📖 *Σ-7-Series AC Servo Drive Σ-7S SERVOPACK with FT/EX Specification for SGM7D Motor Product Manual* (Manual No.: SIEP S800001 91)

*6. The BTO specification indicates if the SERVOPACK is customized by using the MechatroCloud BTO service. You need a BTO number to order SERVOPACKs with customized specifications. Refer to page M-15 for the details on the BTO service.

Ratings and Specifications

Ratings

◆ Three-Phase, 200 VAC

Model SGD7S-		2R8A	120A
Maximum Applicable Motor Capacity [kW]		0.4	1.5
Continuous Output Current [Arms]		2.8	11.6
Instantaneous Maximum Output Current [Arms]		9.3	28
Main Circuit	Power Supply	200 VAC to 240 VAC, -15% to +10%, 50 Hz/60 Hz	
	Input Current [Arms]*	2.5	7.3
Control	Power Supply	200 VAC to 240 VAC, -15% to +10%, 50 Hz/60 Hz	
	Input Current [Arms]*	0.2	0.2
Power Supply Capacity [kVA]*		1.0	3.2
Power Loss*	Main Circuit Power Loss [W]	22.5	72.6
	Control Circuit Power Loss [W]	12	15
	Built-in Regenerative Resistor Power Loss [W]	–	10
	Total Power Loss [W]	34.5	97.6
Regenerative Resistor	Built-In Regenerative Resistor	Resistance [Ω]	20
		Capacity [W]	60
	Minimum Allowable External Resistance [Ω]		40
Overvoltage Category		III	

* This is the net value at the rated load.

◆ Single-Phase, 200 VAC

Model SGD7S-		2R8A	120A
Maximum Applicable Motor Capacity [kW]		0.4	1.5
Continuous Output Current [Arms]		2.8	11.6
Instantaneous Maximum Output Current [Arms]		9.3	28
Main Circuit	Power Supply	200 VAC to 240 VAC, -15% to +10%, 50 Hz/60 Hz	
	Input Current [Arms]*	5.0	16
Control	Power Supply	200 VAC to 240 VAC, -15% to +10%, 50 Hz/60 Hz	
	Input Current [Arms]*	0.2	0.25
Power Supply Capacity [kVA]*		1.2	4.0
Power Loss*	Main Circuit Power Loss [W]	23.7	71.8
	Control Circuit Power Loss [W]	12	16
	Built-in Regenerative Resistor Power Loss [W]	–	16
	Total Power Loss [W]	35.7	103.8
Regenerative Resistor	Built-In Regenerative Resistor	Resistance [Ω]	12
		Capacity [W]	60
	Minimum Allowable External Resistance [Ω]		40
Overvoltage Category		III	

* This is the net value at the rated load.

SERVOPACKs

Σ-7S Single-axis FT82 SERVOPACKs SGM7D Motor Drive

◆ Single-phase, 100 VAC

Model SGD7S-		2R8F
Maximum Applicable Motor Capacity [kW]		0.4
Continuous Output Current [Arms]		2.8
Instantaneous Maximum Output Current [Arms]		9.3
Main Circuit	Power Supply	100 VAC to 120 VAC, -15% to +10%, 50 Hz/60 Hz
	Input Current [Arms]*	10
Control	Power Supply	100 VAC to 120 VAC, -15% to +10%, 50 Hz/60 Hz
	Input Current [Arms]*	0.38
Power Supply Capacity [kVA]*		1.4
Power Loss*	Main Circuit Power Loss [W]	26.2
	Control Circuit Power Loss [W]	12
	Total Power Loss [W]	38.2
Regenerative Resistor	Minimum Allowable External Resistance [Ω]	40
Overvoltage Category		III

* This is the net value at the rated load.

SERVOPACK Overload Protection Characteristics

The overload detection level is set for hot start conditions with a SERVOPACK surrounding air temperature of 55°C.

An overload alarm (A.710 or A.720) will occur if overload operation that exceeds the overload protection characteristics shown in the following diagram (i.e., operation on the right side of the applicable line) is performed.

The actual overload detection level will be the detection level of the connected SERVOPACK or Servomotor that has the lower overload protection characteristics.

In most cases, that will be the overload protection characteristics of the Servomotor.

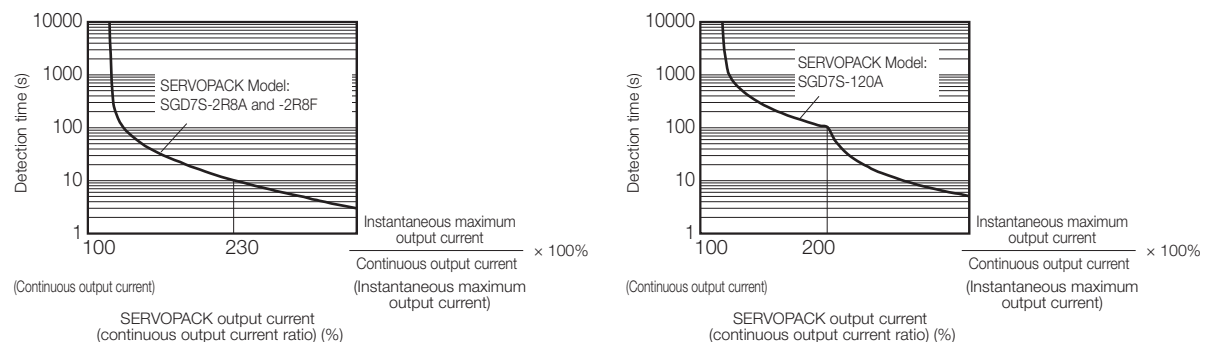



Note: The above overload protection characteristics do not mean that you can perform continuous duty operation with an output of 100% or higher.

For a Yaskawa-specified combination of SERVOPACK and Servomotor, maintain the effective torque (or effective force) within the continuous duty zone of the torque-motor speed characteristic (or force-motor speed characteristics) of the Servomotor.

Specifications

◆ FT82 SERVOPACKs with Analog Voltage/Pulse Train References

Item		Specification						
Control Method		IGBT-based PWM control, sine wave current drive						
Feedback		Serial encoder: 24 bits (incremental encoder/absolute encoder)						
Environmental Conditions	Surrounding Air Temperature* ¹	-5°C to 55°C With derating, usage is possible between 55°C and 60°C. Refer to the following section for derating specifications.  <i>Derating Specifications (page 397)</i>						
	Storage Temperature	-20°C to 85°C						
	Surrounding Air Humidity	95% relative humidity max. (with no freezing or condensation)						
	Storage Humidity	95% relative humidity max. (with no freezing or condensation)						
	Vibration Resistance	4.9 m/s ²						
	Shock Resistance	19.6 m/s ²						
	Degree of Protection	<table border="1"> <thead> <tr> <th>Degree</th> <th>SERVOPACK Models</th> </tr> </thead> <tbody> <tr> <td>IP20</td> <td>SGD7S-2R8A, -120A (three-phase, 200-VAC input), and -2R8F</td> </tr> <tr> <td>IP10</td> <td>SGD7S-120A00A008 (single-phase, 200-VAC input)</td> </tr> </tbody> </table>	Degree	SERVOPACK Models	IP20	SGD7S-2R8A, -120A (three-phase, 200-VAC input), and -2R8F	IP10	SGD7S-120A00A008 (single-phase, 200-VAC input)
	Degree	SERVOPACK Models						
IP20	SGD7S-2R8A, -120A (three-phase, 200-VAC input), and -2R8F							
IP10	SGD7S-120A00A008 (single-phase, 200-VAC input)							
Pollution Degree	2 <ul style="list-style-type: none"> • Must be no corrosive or flammable gases. • Must be no exposure to water, oil, or chemicals. • Must be no dust, salts, or iron dust. 							
Altitude* ¹	1,000 m or less. With derating, usage is possible between 1,000 m and 2,000 m. Refer to the following section for derating specifications.  <i>Derating Specifications (page 397)</i>							
Others	Do not use the SERVOPACK in the following locations: Locations subject to static electricity noise, strong electromagnetic/magnetic fields, or radioactivity							
Applicable Standards		UL 61800-5-1 (E147823), CSA C22.2 No.274, EN ISO13849-1: 2015, EN 55011 group 1 class A, EN 61000-6-2, EN 61000-6-4, EN 61800-3 (Category C2, Second environment), EN 50178, EN 61800-5-1, IEC 60204-1, IEC 61508 series, IEC 62061, IEC 61800-5-2, and IEC 61326-3-1						
Mounting		Base-mounted or rack-mounted						
Performance	Speed Control Range	1:5000 (At the rated torque, the lower limit of the speed control range must not cause the Servomotor to stop.)						
	Coefficient of Speed Fluctuation* ²	±0.01% of rated speed max. (for a load fluctuation of 0% to 100%)						
		0% of rated speed max. (for a load fluctuation of ±10%)						
		±0.1% of rated speed max. (for a temperature fluctuation of 25°C ±25°C)						
Torque Control Precision (Repeatability)	±1%							
Soft Start Time Setting	0 s to 10 s (Can be set separately for acceleration and deceleration.)							

Continued on next page.

Continued from previous page.

Item		Specification	
I/O Signals	Encoder Divided Pulse Output	Phase A, phase B, phase C: Line-driver output Number of divided output pulses: Any setting is allowed.	
	Sequence Input Signals	Fixed Input	Allowable voltage range: 5 VDC ±5% Number of input points: 1 SEN (Absolute Data Request) signal
		Input Signals That Can Be Allocated	Allowable voltage range: 24 VDC ±20% Number of input points: 7 Input method: Sink inputs or source inputs Input Signals <ul style="list-style-type: none"> • /S-ON (Servo ON) signal • /P-CON (Proportional Control) Signal • P-OT (Forward Drive Prohibit) and N-OT (Reverse Drive Prohibit) signals • /ALM-RST (Alarm Reset) signal • /P-CL (Forward External Torque Limit) and /N-CL (Reverse External Torque Limit) signals • /SPD-D (Motor Direction) signal • /SPD-A and /SPD-B (Internal Set Speed Selection) signals • /C-SEL (Control Selection) signal • /ZCLAMP (Zero Clamping) signal • /INHIBIT (Reference Pulse Inhibit) signal • /P-DET (Polarity Detection) signal • /G-SEL (Gain Selection) signal • /PSEL (Reference Pulse Input Multiplication Switch) Signal • SEN (Absolute Data Request) signal A signal can be allocated and the positive and negative logic can be changed.
	Sequence Output Signals	Fixed Output	Allowable voltage range: 5 VDC to 30 VDC Number of output points: 1 Output signal: ALM (Servo Alarm) signal
		Output Signals That Can Be Allocated	Allowable voltage range: 5 VDC to 30 VDC Number of output points: 6 (A photocoupler output (isolated) is used for three of the outputs.) (An open-collector output (non-isolated) is used for the other three outputs.) Output Signals <ul style="list-style-type: none"> • /COIN (Positioning Completion) Signal • /V-CMP (Speed Coincidence Detection) Signal • /TGON (Rotation Detection) Signal • /S-RDY (Servo Ready) signal • /CLT (Torque Limit Detection) Signal • /VLT (Speed Limit Detection) Signal • /BK (Brake) signal • /WARN (Warning) Signal • /NEAR (Near) signal • /PSELA (Reference Pulse Input Multiplication Switching Output) signal • ALO1, ALO2, and ALO3 (Alarm Code) signals A signal can be allocated and the positive and negative logic can be changed.
	Communications	RS-422A Communications (CN3)	Interfaces
1:N Communications			Up to N = 15 stations possible for RS-422A port
Axis Address Setting			Set with parameters.
USB Communications (CN7)		Interface	Personal computer (with SigmaWin+)
	Communications Standard	Conforms to USB2.0 standard (12 Mbps).	
Displays/Indicators		CHARGE indicator and five-digit seven-segment display	
Panel Operator		Four push switches	

Continued on next page.

Continued from previous page.

Item		Specification			
Analog Monitor (CN5)		Number of points: 2 Output voltage range: ±10 VDC (effective linearity range: ±8 V) Resolution: 16 bits Accuracy: ±20 mV (Typ) Maximum output current: ±10 mA Settling time (±1%): 1.2 ms (Typ)			
Dynamic Brake (DB)		Activated when a servo alarm or overtravel (OT) occurs, or when the power supply to the main circuit or servo is OFF.			
Regenerative Processing		Built-in  <i>Built-In Regenerative Resistor (page 472)</i>			
Overtravel (OT) Prevention		Stopping with dynamic brake, deceleration to a stop, or coasting to a stop for the P-OT (Forward Drive Prohibit) or N-OT (Reverse Drive Prohibit) signal			
Protective Functions		Overcurrent, overvoltage, low voltage, overload, regeneration error, etc.			
Utility Functions		Gain adjustment, alarm history, jogging, origin search, etc.			
Safety Functions	Inputs	/HWBB1 and /HWBB2: Base block signals for Power Modules			
	Output	EDM1: Monitors the status of built-in safety circuit (fixed output).			
	Applicable Standards*3	ISO13849-1 PLe (Category 3) and IEC61508 SIL3			
Applicable Option Modules		Fully-closed Modules and Safety Modules Note: You cannot use a Fully-closed Module and a Safety Module together.			
Controls	Speed Control	Soft Start Time Setting	0 s to 10 s (Can be set separately for acceleration and deceleration.)		
		Input Signal	Reference Voltage	• Maximum input voltage: ±12 V (forward motor rotation for positive reference). • 6 VDC at rated speed (default setting). Input gain setting can be changed.	
			Input Impedance	Approx. 14 kΩ	
			Circuit Time Constant	30 μs	
			Internal Set-Speed Control	Rotation Direction Selection	With Proportional Control signal
		Speed Selection		With Forward/Reverse External Torque Limit signals (speed 1 to 3 selection). Servomotor stops or another control method is used when both signals are OFF.	
	Position Control	Feedforward Compensation		0% to 100%	
		Output Signal Positioning Completed Width Setting		0 to 1,073,741,824 reference units	
		Input Signals	Reference pulses	Reference Pulse Form	One of the following is selected: Sign + pulse train, CW + CCW pulse trains, and two-phase pulse trains with 90° phase differential
				Input Form	Line driver or open collector
			Maximum Input Frequency	• Line Driver Sign + pulse train or CW + CCW pulse trains: 4 Mpps Two-phase pulse trains with 90° phase differential: 1 Mpps • Open Collector Sign + pulse train or CW + CCW pulse trains: 200 kpps Two-phase pulse trains with 90° phase differential: 200 kpps	
			Input Multiplication Switching	1 to 100 times	
			Clear Signal	Position deviation clear Line driver or open collector	
		Torque Control	Input Signal	Reference Voltage	• Maximum input voltage: ±12 V (forward torque output for positive reference). • 3 VDC at rated torque (default setting). Input gain setting can be changed.
				Input Impedance	Approx. 14 kΩ
				Circuit Time Constant	16 μs



*1. If you combine a Σ-7-Series SERVOPACK with a Σ-V-Series Option Module, the following Σ-V-Series SERVO-PACKs specifications must be used: a surrounding air temperature of 0°C to 55°C and an altitude of 1,000 m max. Also, the applicable surrounding range cannot be increased by derating.

*2. The coefficient of speed fluctuation for load fluctuation is defined as follows:

$$\text{Coefficient of speed fluctuation} = \frac{\text{No-load motor speed} - \text{Total-load motor speed}}{\text{Rated motor speed}} \times 100\%$$

*3. Always perform risk assessment for the system and confirm that the safety requirements are met.

◆ FT82 SERVOPACK with MECHATROLINK-II Communications References

Item		Specification						
Control Method		IGBT-based PWM control, sine wave current drive						
Feedback		Serial encoder: 24 bits (incremental encoder/absolute encoder)						
Environmental Conditions	Surrounding Air Temperature*1	-5°C to 55°C With derating, usage is possible between 55°C and 60°C. Refer to the following section for derating specifications.  <i>Derating Specifications (page 397)</i>						
	Storage Temperature	-20°C to 85°C						
	Surrounding Air Humidity	95% relative humidity max. (with no freezing or condensation)						
	Storage Humidity	95% relative humidity max. (with no freezing or condensation)						
	Vibration Resistance	4.9 m/s ²						
	Shock Resistance	19.6 m/s ²						
	Degree of Protection	<table border="1"> <thead> <tr> <th>Degree</th> <th>SERVOPACK Models</th> </tr> </thead> <tbody> <tr> <td>IP20</td> <td>SGD7S-2R8A, -120A (three-phase, 200-VAC input), and -2R8F</td> </tr> <tr> <td>IP10</td> <td>SGD7S-120A10A008 (single-phase, 200-VAC input)</td> </tr> </tbody> </table>	Degree	SERVOPACK Models	IP20	SGD7S-2R8A, -120A (three-phase, 200-VAC input), and -2R8F	IP10	SGD7S-120A10A008 (single-phase, 200-VAC input)
	Degree	SERVOPACK Models						
	IP20	SGD7S-2R8A, -120A (three-phase, 200-VAC input), and -2R8F						
IP10	SGD7S-120A10A008 (single-phase, 200-VAC input)							
Pollution Degree	2 <ul style="list-style-type: none"> • Must be no corrosive or flammable gases. • Must be no exposure to water, oil, or chemicals. • Must be no dust, salts, or iron dust. 							
Altitude*1	1,000 m or less. With derating, usage is possible between 1,000 m and 2,000 m. Refer to the following section for derating specifications.  <i>Derating Specifications (page 397)</i>							
Others	Do not use the SERVOPACK in the following locations: Locations subject to static electricity noise, strong electromagnetic/magnetic fields, or radioactivity							
Applicable Standards		UL 61800-5-1 (E147823), CSA C22.2 No.274, EN ISO13849-1: 2015, EN 55011 group 1 class A, EN 61000-6-2, EN 61000-6-4, EN 61800-3 (Category C2, Second environment), EN 50178, EN 61800-5-1, IEC 60204-1, IEC 61508 series, IEC 62061, IEC 61800-5-2, and IEC 61326-3-1						
Mounting		Base-mounted or rack-mounted						
Performance	Speed Control Range	1:5000 (At the rated torque, the lower limit of the speed control range must not cause the Servomotor to stop.)						
	Coefficient of Speed Fluctuation*2	±0.01% of rated speed max. (for a load fluctuation of 0% to 100%)						
		0% of rated speed max. (for a voltage fluctuation of ±10%)						
		±0.1% of rated speed max. (for a temperature fluctuation of 25°C ±25°C)						
Torque Control Precision (Repeatability)	±1%							
Soft Start Time Setting		0 s to 10 s (Can be set separately for acceleration and deceleration.)						

Continued on next page.

Continued from previous page.

Item		Specification	
I/O Signals	Encoder Divided Pulse Output	Phase A, phase B, phase C: Line-driver output Number of divided output pulses: Any setting is allowed.	
	Sequence Input Signals	Input Signals That Can Be Allocated	
		Input Signals That Can Be Allocated	Allowable voltage range: 24 VDC ±20% Number of input points: 7 Input method: Sink inputs or source inputs Input Signals <ul style="list-style-type: none"> • /DEC (Origin Return Deceleration Switch) signal • /EXT1 to /EXT3 (External Latch Input 1 to 3) signals • P-OT (Forward Drive Prohibit) and N-OT (Reverse Drive Prohibit) signals • /P-CL (Forward External Torque Limit) and /N-CL (Reverse External Torque Limit) signals • /P-DET (Polarity Detection) signal A signal can be allocated and the positive and negative logic can be changed.
	Sequence Output Signals	Fixed Output	Allowable voltage range: 5 VDC to 30 VDC Number of output points: 1 Output signal: ALM (Servo Alarm) signal
Output Signals That Can Be Allocated		Allowable voltage range: 5 VDC to 30 VDC Number of output points: 3 (A photocoupler output (isolated) is used.) Output Signals <ul style="list-style-type: none"> • /COIN (Positioning Completion) signal • /V-CMP (Speed Coincidence Detection) signal • /TGON (Rotation Detection) signal • /S-RDY (Servo Ready) signal • /CLT (Torque Limit Detection) signal • /VLT (Speed Limit Detection) signal • /BK (Brake) signal • /WARN (Warning) signal • /NEAR (Near) signal A signal can be allocated and the positive and negative logic can be changed.	
Communications	RS-422A Communications (CN3)	Interfaces	Digital Operator (JUSP-OP05A-1-E) and personal computer (with SigmaWin+)
		1:N Communications	Up to N = 15 stations possible for RS-422A port
		Axis Address Setting	Set with parameters.
	USB Communications (CN7)	Interface	Personal computer (with SigmaWin+)
Communications Standard		Conforms to USB2.0 standard (12 Mbps).	
Displays/Indicators		CHARGE, PWR, and COM indicators, and one-digit seven-segment display	
MECHATROLINK-II Communications	Communications Protocol	MECHATROLINK-II	
	Station Address Settings	41 to 5F hex (maximum number of slaves: 30) Selected with the combination of a rotary switch (S2) and DIP switch (S3).	
	Baud Rate	10 Mbps, 4 Mbps A DIP switch (S3) is used to select the baud rate.	
	Transmission Cycle	250 μs or 0.5 ms to 4.0 ms (multiples of 0.5 ms)	
	Number of Transmission Bytes	17 or 32 bytes/station A DIP switch (S3) is used to select the number of transmission bytes.	
Reference Method	Performance	Position, speed, or torque control with MECHATROLINK-II communications	
	Reference Input	MECHATROLINK-I or MECHATROLINK-II commands (sequence, motion, data setting, data access, monitoring, adjustment, etc.)	
MECHATROLINK-II Communications Setting Switches		Rotary switch (S2) positions: 16 Number of DIP switch (S3) pins: 4	

Continued on next page.

SERVOPACKs

Σ-7S Single-axis FT82 SERVOPACKs SGM7D Motor Drive

Continued from previous page.

Item		Specification
Analog Monitor (CN5)		Number of points: 2 Output voltage range: ±10 VDC (effective linearity range: ±8 V) Resolution: 16 bits Accuracy: ±20 mV (Typ) Maximum output current: ±10 mA Settling time (±1%): 1.2 ms (Typ)
Dynamic Brake (DB)		Activated when a servo alarm or overtravel (OT) occurs, or when the power supply to the main circuit or servo is OFF.
Regenerative Processing		Built-in  <i>Built-In Regenerative Resistor</i> (page 472)
Overtravel (OT) Prevention		Stopping with dynamic brake, deceleration to a stop, or coasting to a stop for the P-OT (Forward Drive Prohibit) or N-OT (Reverse Drive Prohibit) signal
Protective Functions		Overcurrent, overvoltage, low voltage, overload, regeneration error, etc.
Utility Functions		Gain adjustment, alarm history, jogging, origin search, etc.
Safety Functions	Inputs	/HWBB1 and /HWBB2: Base block signals for Power Modules
	Output	EDM1: Monitors the status of built-in safety circuit (fixed output).
	Applicable Standards*3	ISO13849-1 PLe (Category 3), IEC61508 SIL3
Applicable Option Modules		Fully-closed Modules and Safety Modules Note: You cannot use a Fully-closed Module and a Safety Module together.



*1. If you combine a Σ-7-Series SERVOPACK with a Σ-V-Series Option Module, the following Σ-V-Series SERVO-PACKs specifications must be used: a surrounding air temperature of 0°C to 55°C and an altitude of 1,000 m max. Also, the applicable surrounding range cannot be increased by derating.

*2. The coefficient of speed fluctuation for load fluctuation is defined as follows:

$$\text{Coefficient of speed fluctuation} = \frac{\text{No-load motor speed} - \text{Total-load motor speed}}{\text{Rated motor speed}} \times 100\%$$

*3. Always perform risk assessment for the system and confirm that the safety requirements are met.

◆ FT82 SERVOPACK with MECHATROLINK-III Communications References

Item		Specification						
Drive Method		IGBT-based PWM control, sine wave current drive						
Feedback		Serial encoder: 24 bits (incremental encoder/absolute encoder)						
Environmental Conditions	Surrounding Air Temperature* ¹	-5°C to 55°C With derating, usage is possible between 55°C and 60°C. Refer to the following section for derating specifications.  <i>Derating Specifications (page 397)</i>						
	Storage Temperature	-20°C to 85°C						
	Surrounding Air Humidity	95% relative humidity max. (with no freezing or condensation)						
	Storage Humidity	95% relative humidity max. (with no freezing or condensation)						
	Vibration Resistance	4.9 m/s ²						
	Shock Resistance	19.6 m/s ²						
	Degree of Protection	<table border="1"> <thead> <tr> <th>Degree</th> <th>SERVOPACK Models</th> </tr> </thead> <tbody> <tr> <td>IP20</td> <td>SGD7S-2R8A, -120A (three-phase, 200-VAC input), and -2R8F</td> </tr> <tr> <td>IP10</td> <td>SGD7S-120A20A008 (single-phase, 200-VAC input)</td> </tr> </tbody> </table>	Degree	SERVOPACK Models	IP20	SGD7S-2R8A, -120A (three-phase, 200-VAC input), and -2R8F	IP10	SGD7S-120A20A008 (single-phase, 200-VAC input)
	Degree	SERVOPACK Models						
	IP20	SGD7S-2R8A, -120A (three-phase, 200-VAC input), and -2R8F						
	IP10	SGD7S-120A20A008 (single-phase, 200-VAC input)						
Pollution Degree	2 <ul style="list-style-type: none"> • Must be no corrosive or flammable gases. • Must be no exposure to water, oil, or chemicals. • Must be no dust, salts, or iron dust. 							
Altitude* ¹	1,000 m or less. With derating, usage is possible between 1,000 m and 2,000 m. Refer to the following section for derating specifications.  <i>Derating Specifications (page 397)</i>							
Others	Do not use the SERVOPACK in the following locations: Locations subject to static electricity noise, strong electromagnetic/magnetic fields, or radioactivity							
Applicable Standards		UL 61800-5-1 (E147823), CSA C22.2 No.274, EN ISO13849-1: 2015, EN 55011 group 1 class A, EN 61000-6-2, EN 61000-6-4, EN 61800-3 (Category C2, Second environment), EN 50178, EN 61800-5-1, IEC 60204-1, IEC 61508 series, IEC 62061, IEC 61800-5-2, and IEC 61326-3-1						
Mounting		Base-mounted or rack-mounted						
Performance	Speed Control Range	1:5000 (At the rated torque, the lower limit of the speed control range must not cause the Servomotor to stop.)						
	Coefficient of Speed Fluctuation* ²	±0.01% of rated speed max. (for a load fluctuation of 0% to 100%)						
		0% of rated speed max. (for a load fluctuation of ±10%)						
	Torque Control Precision (Repeatability)	±1%						
Soft Start Time Setting		0 s to 10 s (Can be set separately for acceleration and deceleration.)						

Continued on next page.

SERVOPACKs

Σ-7S Single-axis FT82 SERVOPACKs SGM7D Motor Drive

Continued from previous page.

Item		Specification
I/O Signals	Encoder Divided Pulse Output	Phase A, phase B, phase C: Line-driver output Number of divided output pulses: Any setting is allowed.
	Sequence Input Signals	Input Signals That Can Be Allocated
		Input Signals That Can Be Allocated
	Sequence Output Signals	Fixed Output
Output Signals That Can Be Allocated		
Communications	RS-422A Communications (CN3)	Interfaces
		1:N Communications
		Axis Address Setting
	USB Communications (CN7)	Interface
Communications Standard		
Displays/Indicators		CHARGE, PWR, CN, L1, and L2 indicators, and one-digit seven-segment display
MECHATROLINK-III Communications	Communications Protocol	MECHATROLINK-III
	Station Address Settings	03 to EF hex (maximum number of slaves: 62) The rotary switches (S1 and S2) are used to set the station address.
	Baud Rate	100 Mbps
	Transmission Cycle	125 μs, 250 μs, 500 μs, 750 μs, 1.0 ms to 4.0 ms (multiples of 0.5 ms)
	Number of Transmission Bytes	32 or 48 bytes/station A DIP switch (S3) is used to select the number of transmission bytes.
Reference Method	Performance	Position, speed, or torque control with MECHATROLINK-III communications
	Reference Input	MECHATROLINK-III commands (sequence, motion, data setting, data access, monitoring, adjustment, etc.)
	Profile	MECHATROLINK-III standard servo profile
MECHATROLINK-III Communications Setting Switches		Rotary switch (S1 and S2) positions: 16 Number of DIP switch (S3) pins: 4

Continued on next page.

Continued from previous page.

Item		Specification
Analog Monitor (CN5)		Number of points: 2 Output voltage range: ±10 VDC (effective linearity range: ±8 V) Resolution: 16 bits Accuracy: ±20 mV (Typ) Maximum output current: ±10 mA Settling time (±1%): 1.2 ms (Typ)
Dynamic Brake (DB)		Activated when a servo alarm or overtravel (OT) occurs, or when the power supply to the main circuit or servo is OFF.
Regenerative Processing		Built-in  <i>Built-In Regenerative Resistor</i> (page 472)
Overtravel (OT) Prevention		Stopping with dynamic brake, deceleration to a stop, or coasting to a stop for the P-OT (Forward Drive Prohibit) or N-OT (Reverse Drive Prohibit) signal
Protective Functions		Overcurrent, overvoltage, low voltage, overload, regeneration error, etc.
Utility Functions		Gain adjustment, alarm history, jogging, origin search, etc.
Safety Functions	Inputs	/HWBB1 and /HWBB2: Base block signals for Power Modules
	Output	EDM1: Monitors the status of built-in safety circuit (fixed output).
	Applicable Standards*3	ISO13849-1 PLe (Category 3), IEC61508 SIL3
Applicable Option Modules		Fully-closed Modules and Safety Modules Note: You cannot use a Fully-closed Module and a Safety Module together.

*1. If you combine a Σ-7-Series SERVOPACK with a Σ-V-Series Option Module, the following Σ-V-Series SERVOPACKs specifications must be used: a surrounding air temperature of 0°C to 55°C and an altitude of 1,000 m max. Also, the applicable surrounding range cannot be increased by derating.

*2. The coefficient of speed fluctuation for load fluctuation is defined as follows:

$$\text{Coefficient of speed fluctuation} = \frac{\text{No-load motor speed} - \text{Total-load motor speed}}{\text{Rated motor speed}} \times 100\%$$

*3. Always perform risk assessment for the system and confirm that the safety requirements are met.

◆ Command Option Attachable-type FT82 SERVOPACKs with INDEXER Modules

The specifications when the INDEXER Module is combined with a Command Option Attachable-type SERVOPACK are given in the following table.

Item		Specification
Control Method		IGBT-based PWM control, sine wave current drive
Feedback		Serial encoder: 24 bits (incremental encoder/absolute encoder)
Environmental Conditions	Surrounding Air Temperature	0°C to 55°C
	Storage Temperature	-20°C to 85°C
	Surrounding Air Humidity	90% relative humidity max. (with no freezing or condensation)
	Storage Humidity	90% relative humidity max. (with no freezing or condensation)
	Vibration Resistance	4.9 m/s ²
	Shock Resistance	19.6 m/s ²
	Degree of Protection	IP10
	Pollution Degree	2 <ul style="list-style-type: none"> • Must be no corrosive or flammable gases. • Must be no exposure to water, oil, or chemicals. • Must be no dust, salts, or iron dust.
	Altitude	1,000 m or less.
Others	Do not use the SERVOPACK in the following locations: Locations subject to static electricity noise, strong electromagnetic/magnetic fields, or radioactivity	
Applicable Standards		UL 61800-5-1 (E147823), CSA C22.2 No.274, EN ISO13849-1: 2015, EN 55011 group 1 class A, EN 61000-6-2, EN 61000-6-4, EN 61800-3 (Category C2, Second environment), EN 50178, EN 61800-5-1, IEC 60204-1, IEC 61508 series, IEC 62061, IEC 61800-5-2, and IEC 61326-3-1
Mounting		Base-mounted or rack-mounted
Performance	Speed Control Range	1:5000 (At the rated torque, the lower limit of the speed control range must not cause the Servomotor to stop.)
	Coefficient of Speed Fluctuation* ¹	±0.01% of rated speed max. (for a load fluctuation of 0% to 100%)
		0% of rated speed max. (for a voltage fluctuation of ±10%)
		±0.1% of rated speed max. (for a temperature fluctuation of 25°C ±25°C)
Torque Control Precision (Repeatability)	±1%	
Soft Start Time Setting		0 s to 10 s (Can be set separately for acceleration and deceleration.)
I/O Signals	Encoder Divided Pulse Output	Phase A, phase B, phase C: Line-driver output Number of divided output pulses: Any setting is allowed.

Continued on next page.

Continued from previous page.



I/O Signals		Item	Specification	
I/O Signals	Sequence Input Signals	SERVOPACK	Allowable voltage range: 24 VDC ±20% Number of input points: 6	
			Input method: Sink inputs or source inputs Input signals: <ul style="list-style-type: none"> • /ALM-RST (Alarm Reset) signal • P-OT (Forward Drive Prohibit) signal • N-OT (Reverse Drive Prohibit) signal • /DEC (Origin Return Deceleration) switch • /RGRT (Registration Input) signal • /S-ON (Servo ON) signal Positive or negative logic can be changed in the parameters.	
	INDEXER Module	Fixed Inputs	Allowable voltage range: 24 VDC ±10% Number of input points: 11	
			/MODE 0/1 (Mode Switch Input) signal	
			Mode 0	Mode 1
			<ul style="list-style-type: none"> • /START-STOP (Program Table Operation Start-Stop Input) signal • /PGMRES (Program Table Operation Reset Input) signal • /SEL0 (Program Step Selection Input 0) signal • /SEL1 (Program Step Selection Input 1) signal • /SEL2 (Program Step Selection Input 2) signal • /SEL3 (Program Step Selection Input 3) signal • /SEL4 (Program Step Selection Input 4) signal • /SEL5 (Program Step Selection Input 5) signal • /SEL6 (Program Step Selection Input 6) signal • /SEL7 (Program Step Selection Input 7) signal 	<ul style="list-style-type: none"> • /HOME (Origin Return Input) signal • /JOGP (Forward Jog Input) signal • /JOGN (Reverse Jog Input) signal • /JOG0 (Jog Speed Table Selection Input 0) signal • /JOG1 (Jog Speed Table Selection Input 1) signal • /JOG2 (Jog Speed Table Selection Input 2) signal • /JOG3 (Jog Speed Table Selection Input 3) signal
Sequence Output Signals	SERVOPACK	Fixed Outputs	Allowable voltage range: 5 VDC to 30 VDC Number of output points: 1 Output signal: ALM (Servo Alarm Output) signal	
		Output Signals for Which Allocations Can Be Changed	Allowable voltage range: 5 VDC to 30 VDC Number of output points: 3 (A photocoupler output (isolated) is used.) Output signals: <ul style="list-style-type: none"> • /WARN (Warning Output) signal • /BK (Brake Output) signal • /S-RDY (Servo Ready Output) signal • /ALO1, /ALO2, and /ALO3 (Alarm Code Output) signals Signal allocations and positive or negative logic can be changed in the parameters.	
	INDEXER Module	Fixed Outputs	Allowable voltage range: 5 VDC to 30 VDC Number of output points: 9 Output signals: <ul style="list-style-type: none"> • /INPOSITION (Positioning Completion Output) signal • /POUT0 (Programmable Output 0) signal • /POUT1 (Programmable Output 1) signal • /POUT2 (Programmable Output 2) signal • /POUT3 (Programmable Output 3) signal • /POUT4 (Programmable Output 4) signal • /POUT5 (Programmable Output 5) signal • /POUT6 (Programmable Output 6) signal • /POUT7 (Programmable Output 7) signal 	

Continued on next page.

SERVOPACKs

Σ-7S Single-axis FT82 SERVOPACKs SGM7D Motor Drive

Continued from previous page.

Item		Specification	
Communications	RS-422A Communications (CN3)	Interfaces	Digital Operator (JUSP-OP05A-1-E), Personal computer (with SigmaWin+)
		1:N Communications	Up to N = 15 stations possible for RS-422A port
		Axis Address Setting	Set with parameters.
	USB Communications (CN7)	Interface	Personal computer (with SigmaWin+)
Communications Standard		Conforms to USB2.0 standard (12 Mbps).	
Displays/Indicators	SERVOPACK	CHARGE and PWR indicators, and one-digit seven-segment display	
	INDEXER Module	Refer to the following manual for details.  <i>Σ-7-Series Σ-7S Command Option Attachable-type SERVOPACK with INDEXER Module Product Manual (Manual No.: SIEP S800001 64)</i>	
Operating Methods	Program Table Method		<ul style="list-style-type: none"> • Program table positioning in which steps are executed sequentially by commands given through contact input or serial communications • Positioning in which station numbers are specified by commands given through contact input or serial communications
		Max. Number of Steps	256
		Max. Number of Tables	256
		Max. Number of Stations	256
	Serial Communications Method	Serial command by 1-channel ASCII code Communications specifications:RS-422/485 (50 m max.) Connection topology:Multi-drop connection (16 axes max.) Baud rate:9600, 19200, 38400 bps	
Other Functions	Registration (positioning by external signals), origin return		
Analog Monitor (CN5)	Number of points: 2 Output voltage range: ±10 VDC (effective linearity range: ±8 V) Resolution: 16 bits Accuracy: ±20 mV (Typ) Maximum output current: ±10 mA Settling time (±1%): 1.2 ms (Typ)		
Dynamic Brake (DB)	Activated when a servo alarm or overtravel (OT) occurs, or when the power supply to the main circuit or servo is OFF.		
Regenerative Processing	Built-in  <i>Built-In Regenerative Resistor (page 472)</i>		
Overtravel (OT) Prevention	Stopping with dynamic brake, deceleration to a stop, or coasting to a stop for the P-OT (Forward Drive Prohibit) or N-OT (Reverse Drive Prohibit) signal		
Protective Functions	Overcurrent, overvoltage, low voltage, overload, regeneration error, etc.		
Utility Functions	Gain adjustment, alarm history, jogging, origin search, etc.		
Safety Functions	Inputs	/HWBB1 and /HWBB2: Base block signals for Power Modules	
	Output	EDM1: Monitors the status of built-in safety circuit (fixed output).	
	Applicable Standards*2	ISO13849-1 PLe (Category 3), IEC61508 SIL3	
Applicable Option Modules	Fully-Closed Module Note: You cannot use a Safety Module if you are using an INDEXER Module.		

*1. The coefficient of speed fluctuation for load fluctuation is defined as follows:

$$\text{Coefficient of speed fluctuation} = \frac{\text{No-load motor speed} - \text{Total-load motor speed}}{\text{Rated motor speed}} \times 100\%$$

*2. Always perform risk assessment for the system and confirm that the safety requirements are met.

Derating Specifications

If you use the SERVOPACK at a surrounding air temperature of 55°C to 60°C or at an altitude of 1,000 m to 2,000 m, you must apply the derating rates given in the following graphs.

◆ SGD7S-2R8A and -2R8F

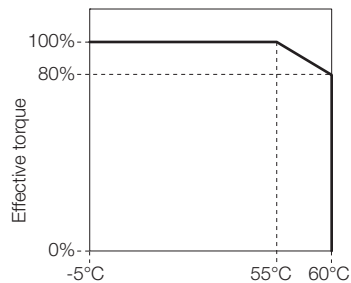

Surrounding air temperature

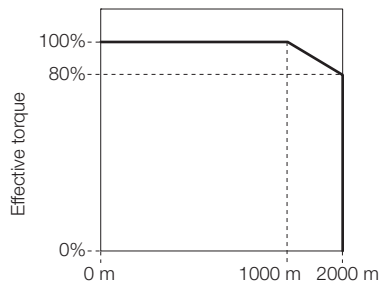

Altitude

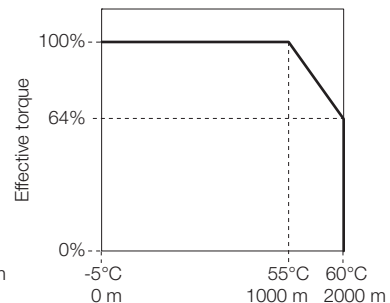

Surrounding air temperature and altitude

◆ SGD7S-120A

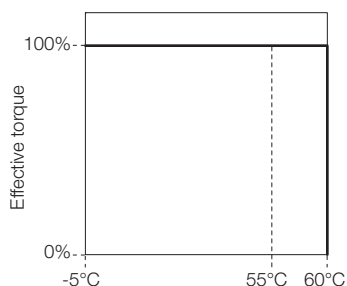

Surrounding air temperature

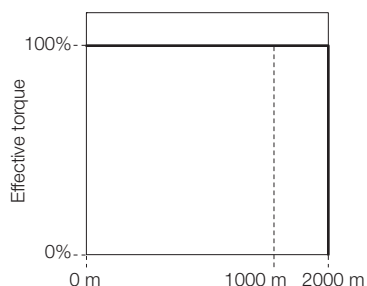

Altitude

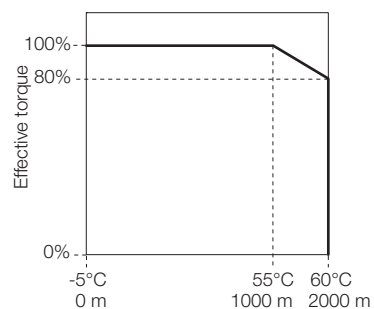

Surrounding air temperature and altitude

Selecting Cables

◆ System Configurations

■ Σ-7S Single-axis Analog Voltage/Pulse Train Reference SERVOPACKs

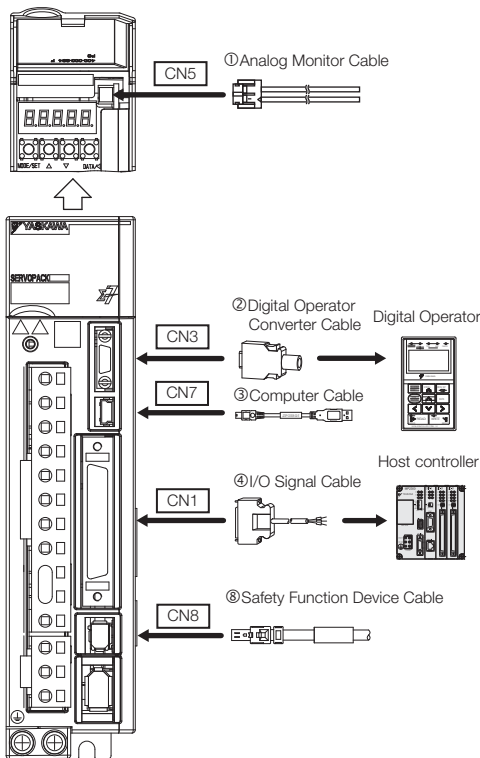

■ Σ-7S Single-axis MECHATROLINK-II Communications Reference SERVOPACKs

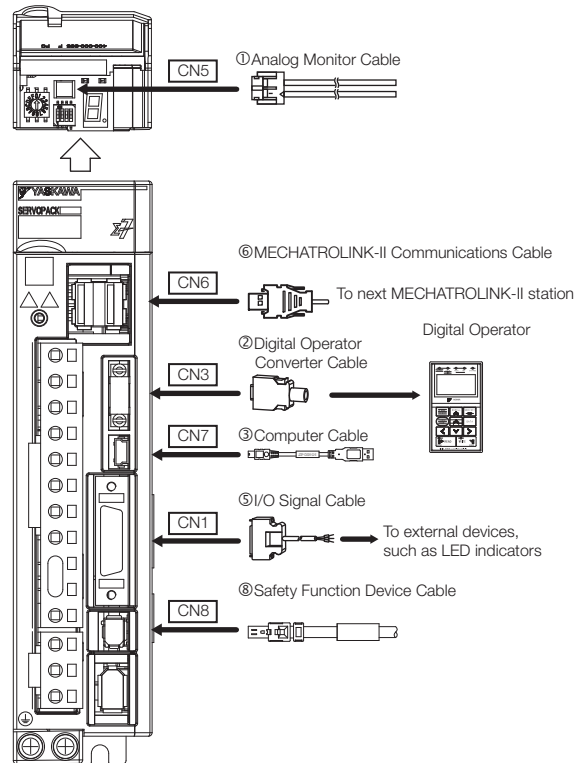

■ Σ-7S Single-axis MECHATROLINK-III Communications Reference SERVOPACKs

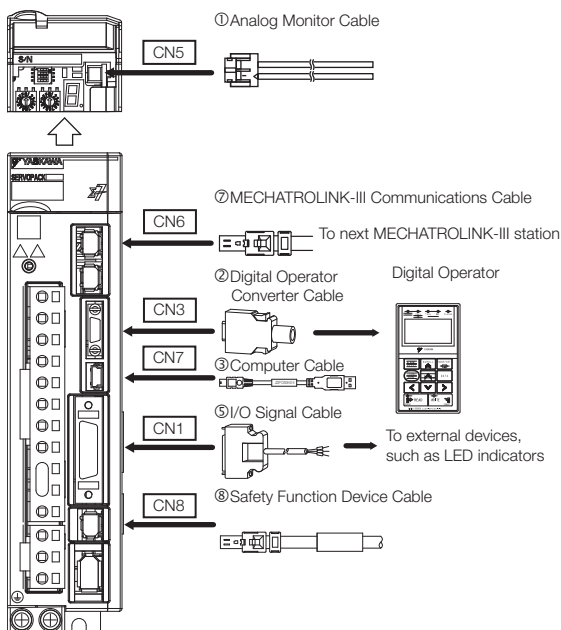

■ Σ-7S Single-axis Command Option Attachable-Type SERVOPACKs

■ Command Option Module: INDEXER Module

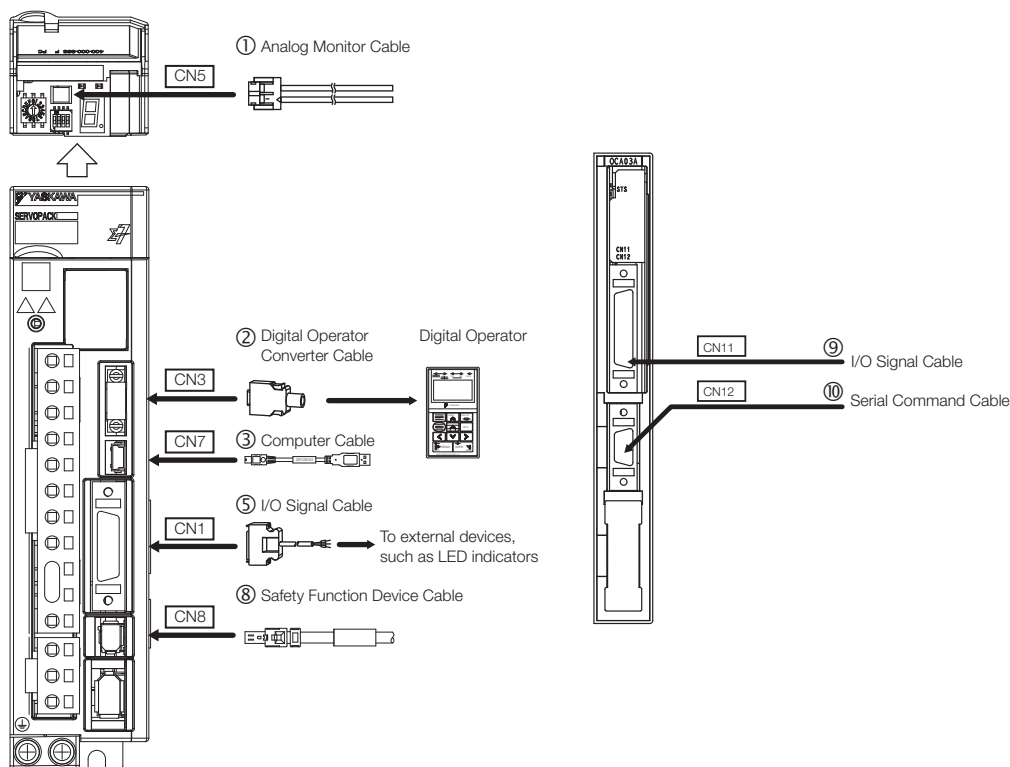

◆ Selection Table

Important

1. Use the cable specified by Yaskawa for the Computer Cable. Operation may not be dependable with any other cable.
2. Use the cable specified by Yaskawa for the MECHATROLINK Communications Cables. Operation may not be dependable due to low noise resistance with any other cable.

Note: Refer to the following manual for the following information.

- Cable dimensional drawings and cable connection specifications
- Order numbers and specifications of individual connectors for cables

📖 *Σ-7-Series AC Servo Drive Peripheral Device Selection Manual (Manual No.: SIEP S800001 32)*







Code	Name	Length (L)	Order Number	Appearance
①	Analog Monitor Cable	1 m	JZSP-CA01-E	
②	Digital Operator Converter Cable	0.3 m	JZSP-CVS05-A3-E*1	
			JZSP-CVS07-A3-E*2	
③	Computer Cable	2.5 m	JZSP-CVS06-02-E	

Continued on next page.

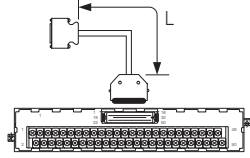
SERVOPACKs

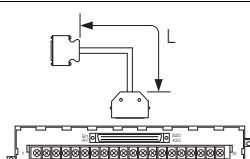
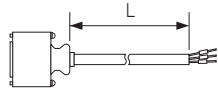

Σ-7S Single-axis FT82 SERVOPACKs SGM7D Motor Drive

Continued from previous page.

Code	Name	Length (L)	Order Number	Appearance	
④	I/O Signal Cables	Soldered Connector Kit	JZSP-CSI9-1-E		
		Connector-Terminal Block Converter Unit (with cable)	0.5 m	JUSP-TA50PG-E	
			1 m	JUSP-TA50PG-1-E	
			2 m	JUSP-TA50PG-2-E	
		Cable with Loose Wires at One End (loose wires on peripheral device end)	1 m	JZSP-CSI01-1-E	
			2 m	JZSP-CSI01-2-E	
			3 m	JZSP-CSI01-3-E	
⑤	I/O Signal Cables	Soldered Connector Kit	JZSP-CSI9-2-E		
		Connector-Terminal Block Converter Unit (with cable)	0.5 m	JUSP-TA26P-E	
			1 m	JUSP-TA26P-1-E	
			2 m	JUSP-TA26P-2-E	
		Cable with Loose Wires at One End (loose wires on peripheral device end)	1 m	JZSP-CSI02-1-E	
			2 m	JZSP-CSI02-2-E	
			3 m	JZSP-CSI02-3-E	
⑥	MECHATRO LINK-II Communications Cables	Cables with Connectors on Both Ends	0.5 m	JEPMC-W6002-A5-E	
			1 m	JEPMC-W6002-01-E	
			3 m	JEPMC-W6002-03-E	
			5 m	JEPMC-W6002-05-E	
			10 m	JEPMC-W6002-10-E	
			20 m	JEPMC-W6002-20-E	
			30 m	JEPMC-W6002-30-E	
			40 m	JEPMC-W6002-40-E	
			50 m	JEPMC-W6002-50-E	
		Cables with Connectors on Both Ends (with ferrite cores)	0.5 m	JEPMC-W6003-A5-E	
			1 m	JEPMC-W6003-01-E	
			3 m	JEPMC-W6003-03-E	
			5 m	JEPMC-W6003-05-E	
			10 m	JEPMC-W6003-10-E	
			20 m	JEPMC-W6003-20-E	
			30 m	JEPMC-W6003-30-E	
			40 m	JEPMC-W6003-40-E	
		50 m	JEPMC-W6003-50-E		
		Terminators		JEPMC-W6022-E	

Continued on next page.

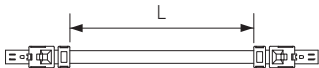
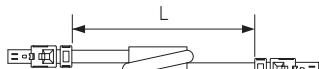
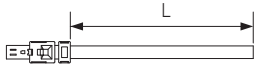
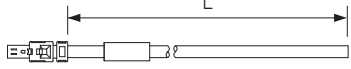
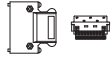
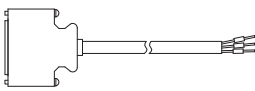
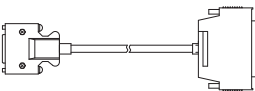
Continued from previous page.

Code	Name	Length (L)	Order Number	Appearance	
⑦	MECHATRO LINK-III Communications Cables	Cables with Connectors on Both Ends	0.2 m	JEPMC-W6012-A2-E	
			0.5 m	JEPMC-W6012-A5-E	
			1 m	JEPMC-W6012-01-E	
			2 m	JEPMC-W6012-02-E	
			3 m	JEPMC-W6012-03-E	
			4 m	JEPMC-W6012-04-E	
			5 m	JEPMC-W6012-05-E	
			10 m	JEPMC-W6012-10-E	
			20 m	JEPMC-W6012-20-E	
			30 m	JEPMC-W6012-30-E	
			50 m	JEPMC-W6012-50-E	
		Cables with Connectors on Both Ends (with core)	10 m	JEPMC-W6013-10-E	
			20 m	JEPMC-W6013-20-E	
			30 m	JEPMC-W6013-30-E	
			50 m	JEPMC-W6013-50-E	
		Cable with Loose Wires at One End	0.5 m	JEPMC-W6014-A5-E	
			1 m	JEPMC-W6014-01-E	
			3 m	JEPMC-W6014-03-E	
			5 m	JEPMC-W6014-05-E	
10 m	JEPMC-W6014-10-E				
30 m	JEPMC-W6014-30-E				
50 m	JEPMC-W6014-50-E				
⑧	Safety Function Device Cables	Cables with Connectors*3	1 m	JZSP-CVH03-01-E	
			3 m	JZSP-CVH03-03-E	
		Connector Kit*4	Contact Tyco Electronics Japan G.K. Product name: Industrial Mini I/O D-shape Type 1 Plug Connector Kit Model number: 2013595-1		
⑨	I/O Signal Cables	Connector Kit		DP9420007-E	
		Cables with Loose Wires at One End	1 m	JZSP-CVI01-1-E	
			2 m	JZSP-CVI01-2-E	
			3 m	JZSP-CVI01-3-E	
		Cables with Terminal Block on One End	0.5 m	JUSP-TA36V-E	
			1 m	JUSP-TA36V-1-E	
2 m	JUSP-TA36V-2-E				
⑩	Serial Command Cable	Connector Kit*4	JZSP-CHI9-1	Contact Yaskawa Controls Co., Ltd. for the cable. 	

*1. This Converter Cable is required to use the Σ-III-series Digital Operator (JUSP-OP05A) for Σ-7-series SERVOPACKs.

*2. If you use a MECHATROLINK-III Communications Reference SERVOPACK, this Converter Cable is required to prevent the cable from disconnecting from the Digital Operator.

*3. When using safety functions, connect this Cable to the safety function devices.
When not using safety functions, connect the enclosed Safety Jumper Connector (JZSP-CVH05-E) to the SERVOPACK.

*4. Use the Connector Kit when you make cables yourself.

Σ-7S Single-axis FT83 SERVOPACKs

SGM7D Motor Drive with built-in INDEXER

Model Designations

SGD7S - 2R8 A 00 A 001 F83 B

Σ-7 Series
Σ-7S SERVOPACKs

1st+2nd+3rd digits

4th digit

5th+6th digits

7th digit

8th+9th+10th digits

11th+12th+13th digits

14th digit

1st+2nd+3rd digits Maximum Applicable Motor Capacity

Voltage	Code	Specification
Three-phase, 200 VAC	2R8 ^{*1}	0.4 kW
	120 ^{*2}	1.5 kW
Single-phase, 100 VAC	2R8	0.4 kW

4th digit Voltage

Code	Specification
A	200 VAC
F	100 VAC

5th+6th digits Interface

Code	Specification
00	Analog voltage/pulse train reference

7th digit Design Revision Order

A

8th+9th+10th digits Hardware Options Specification

Code	Specification	Applicable Models
None	Without options	All models
000		
001	Rack-mounted	All models
002	Varnished	All models
008	Single-phase, 200-VAC power supply input	SGD7S-120A
020 ^{*3}	No dynamic brake	SGD7S-2R8A SGD7S-2R8F
	External dynamic brake resistor	SGD7S-120A

11th+12th+13th digits FT/EX Specification

Code	Specification
F83 ^{*4}	Application function option for special motors, SGM7D motor drive, indexing

14th digit BTO Specification^{*5}
(Available in Japan only)

Code	Specification
None	None
B	BTO Specification

*1. You can use these models with either a single-phase or three-phase power supply input.

*2. A model with a single-phase, 200-VAC power supply input is available as a hardware option (model: SGD7S-120A00A008).

*3. Refer to the following manual for details.

📖 *Σ-7-Series AC Servo Drive Σ-7S/Σ-7W SERVOPACK with Hardware Option Specifications Dynamic Brake Product Manual* (Manual No.: SIEP S800001 73)

*4. Refer to the following manual for details.

📖 *Σ-7-Series AC Servo Drive Σ-7S SERVOPACK with FT/EX Specification for SGM7D Motor Product Manual* (Manual No.: SIEP S800001 91)

*5. The BTO specification indicates if the SERVOPACK is customized by using the MechatroCloud BTO service.

You need a BTO number to order SERVOPACKs with customized specifications. Refer to page M-15 for the details on the BTO service.

Ratings and Specifications

Ratings

◆ Three-Phase, 200 VAC

Model SGD7S-		2R8A	120A
Maximum Applicable Motor Capacity [kW]		0.4	1.5
Continuous Output Current [Arms]		2.8	11.6
Instantaneous Maximum Output Current [Arms]		9.3	28
Main Circuit	Power Supply	200 VAC to 240 VAC, -15% to +10%, 50 Hz/60 Hz	
	Input Current [Arms]*	2.5	7.3
Control	Power Supply	200 VAC to 240 VAC, -15% to +10%, 50 Hz/60 Hz	
	Input Current [Arms]*	0.2	0.2
Power Supply Capacity [kVA]*		1.0	3.2
Power Loss*	Main Circuit Power Loss [W]	22.5	72.6
	Control Circuit Power Loss [W]	12	15
	Built-in Regenerative Resistor Power Loss [W]	–	10
	Total Power Loss [W]	34.5	97.6
Regenerative Resistor	Built-In Regenerative Resistor	Resistance [Ω]	20
		Capacity [W]	60
	Minimum Allowable External Resistance [Ω]		40
Overvoltage Category		III	

* This is the net value at the rated load.

◆ Single-Phase, 200 VAC

Model SGD7S-		2R8A	120A
Maximum Applicable Motor Capacity [kW]		0.4	1.5
Continuous Output Current [Arms]		2.8	11.6
Instantaneous Maximum Output Current [Arms]		9.3	28
Main Circuit	Power Supply	200 VAC to 240 VAC, -15% to +10%, 50 Hz/60 Hz	
	Input Current [Arms]*	5.0	16
Control	Power Supply	200 VAC to 240 VAC, -15% to +10%, 50 Hz/60 Hz	
	Input Current [Arms]*	0.2	0.25
Power Supply Capacity [kVA]*		1.2	4.0
Power Loss*	Main Circuit Power Loss [W]	23.7	71.8
	Control Circuit Power Loss [W]	12	16
	Built-in Regenerative Resistor Power Loss [W]	–	16
	Total Power Loss [W]	35.7	103.8
Regenerative Resistor	Built-In Regenerative Resistor	Resistance [Ω]	12
		Capacity [W]	60
	Minimum Allowable External Resistance [Ω]		40
Overvoltage Category		III	

* This is the net value at the rated load.

SERVOPACKs

Σ-7S Single-axis FT83 SERVOPACKs SGM7D Motor Drive with built-in INDEXER

◆ Single-phase, 100 VAC

Model SGD7S-		2R8F
Maximum Applicable Motor Capacity [kW]		0.4
Continuous Output Current [Arms]		2.8
Instantaneous Maximum Output Current [Arms]		9.3
Main Circuit	Power Supply	100 VAC to 120 VAC, -15% to +10%, 50 Hz/60 Hz
	Input Current [Arms]*	10
Control	Power Supply	100 VAC to 120 VAC, -15% to +10%, 50 Hz/60 Hz
	Input Current [Arms]*	0.38
Power Supply Capacity [kVA]*		1.4
Power Loss*	Main Circuit Power Loss [W]	26.2
	Control Circuit Power Loss [W]	12
	Total Power Loss [W]	38.2
Regenerative Resistor	Minimum Allowable External Resistance [Ω]	40
Overvoltage Category		III

* This is the net value at the rated load.

SERVOPACK Overload Protection Characteristics

The overload detection level is set for hot start conditions with a SERVOPACK surrounding air temperature of 55°C.

An overload alarm (A.710 or A.720) will occur if overload operation that exceeds the overload protection characteristics shown in the following diagram (i.e., operation on the right side of the applicable line) is performed.

The actual overload detection level will be the detection level of the connected SERVOPACK or Servomotor that has the lower overload protection characteristics.

In most cases, that will be the overload protection characteristics of the Servomotor.

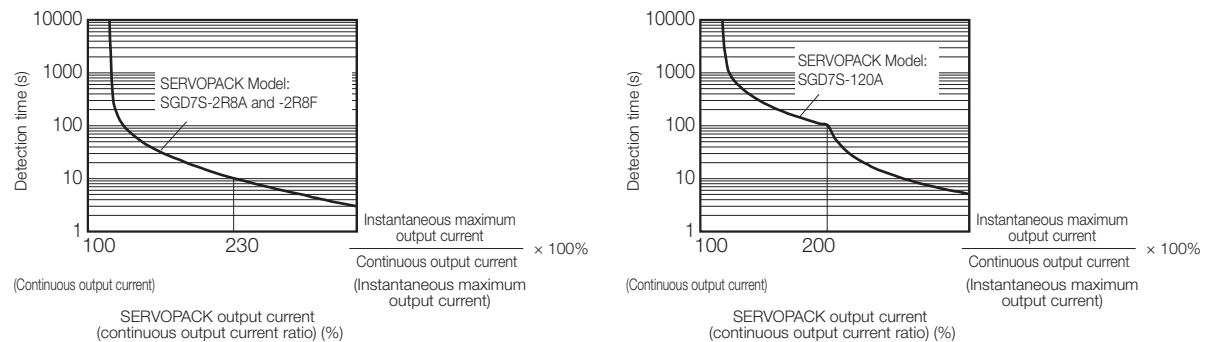

Note: The above overload protection characteristics do not mean that you can perform continuous duty operation with an output of 100% or higher.

For a Yaskawa-specified combination of SERVOPACK and Servomotor, maintain the effective torque (or effective force) within the continuous duty zone of the torque-motor speed characteristic (or force-motor speed characteristics) of the Servomotor.

Specifications

◆ FT83 SERVOPACKs with Analog Voltage/Pulse Train References

Item		Specification
Control Method		IGBT-based PWM control, sine wave current drive
Feedback		Serial encoder: 24 bits (incremental encoder/absolute encoder)
Environmental Conditions	Surrounding Air Temperature* ¹	0°C to 55°C
	Storage Temperature	-20°C to 85°C
	Surrounding Air Humidity	90% relative humidity max. (with no freezing or condensation)
	Storage Humidity	90% relative humidity max. (with no freezing or condensation)
	Vibration Resistance	4.9 m/s ²
	Shock Resistance	19.6 m/s ²
	Degree of Protection	IP10
	Pollution Degree	2 <ul style="list-style-type: none"> • Must be no corrosive or flammable gases. • Must be no exposure to water, oil, or chemicals. • Must be no dust, salts, or iron dust.
	Altitude* ¹	1,000 m max.
Others		Do not use the SERVOPACK in the following locations: Locations subject to static electricity noise, strong electro-magnetic/magnetic fields, or radioactivity
Applicable Standards		UL 61800-5-1 (E147823), CSA C22.2 No.274, EN ISO13849-1: 2015, EN 55011 group 1 class A, EN 61000-6-2, EN 61000-6-4, EN 61800-3 (Category C2, Second environment), EN 50178, EN 61800-5-1, IEC 60204-1, IEC 61508 series, IEC 62061, IEC 61800-5-2, and IEC 61326-3-1
Mounting		Base-mounted or rack-mounted
Performance	Speed Control Range	1:5000 (At the rated torque, the lower limit of the speed control range must not cause the Servomotor to stop.)
	Coefficient of Speed Fluctuation* ²	±0.01% of rated speed max. (for a load fluctuation of 0% to 100%)
		0% of rated speed max. (for a load fluctuation of ±10%)
		±0.1% of rated speed max. (for a temperature fluctuation of 25°C ±25°C)
Torque Control Precision (Repeatability)	±1%	
Soft Start Time Setting	0 s to 10 s (Can be set separately for acceleration and deceleration.)	
I/O Signals	Encoder Divided Pulse Output	Phase A, phase B, phase C: Line-driver output Number of divided output pulses: Any setting is allowed.

Continued on next page.

SERVOPACKs

Σ-7S Single-axis FT83 SERVOPACKs SGM7D Motor Drive with built-in INDEXER

Continued from previous page.

Item		Specification
I/O Signals	Sequence Input Signals	Fixed Input
		SERVOPACKs
	Input Signals for Which Allocations Can Be Changed	<p>Allowable voltage range: 5 VDC ±5% Number of input points: 1 SEN (Absolute Data Request) signal</p> <hr/> <p>Number of input points: 1 Input method: Line driver or open collector Input Signals</p> <ul style="list-style-type: none"> • /DEC (Origin Return Deceleration Switch) signal • /RGRT (Registration Input) signal • CLR (Clear) signal <hr/> <p>Allowable voltage range: 24 VDC ±20% Number of input points: 7 Input method: Sink inputs or source inputs Input Signals</p> <ul style="list-style-type: none"> • /S-ON (Servo ON) signal • /P-CON (Proportional Control) Signal • P-OT (Forward Drive Prohibit) and N-OT (Reverse Drive Prohibit) signals • /ALM-RST (Alarm Reset) signal • /P-CL (Forward External Torque Limit) and /N-CL (Reverse External Torque Limit) signals • /SPD-D (Motor Direction) signal • /SPD-A and /SPD-B (Internal Set Speed Selection) signals • /C-SEL (Control Selection) signal • /ZCLAMP (Zero Clamping) signal • /INHIBIT (Reference Pulse Inhibit) signal • /P-DET (Polarity Detection) signal • /G-SEL (Gain Selection) signal • /PSEL (Reference Pulse Input Multiplication Switch) Signal • SEN (Absolute Data Request) signal • /DEC (Origin Return Deceleration Switch) signal • /MODE 0/1 (Mode Switch Input) signal • /START-STOP (Program Table Operation Start-Stop Input) signal • /JOGP (Forward Jog Input) signal • /JOGN (Reverse Jog Input) signal • /HOME (Origin Return Input) signal • /PGMRES (Program Table Operation Reset Input) signal • /SEL0 (Program Step Selection Input 0) signal • /SEL1 (Program Step Selection Input 1) signal • /SEL2 (Program Step Selection Input 2) signal • /SEL3 (Program Step Selection Input 3) signal • /SEL4 (Program Step Selection Input 4) signal • /JOG0 (Jog Speed Table Selection Input 0) signal • /JOG1 (Jog Speed Table Selection Input 1) signal • /JOG2 (Jog Speed Table Selection Input 2) signal <p>A signal can be allocated and the positive and negative logic can be changed.</p>

Continued on next page.

Continued from previous page.

Item		Specification	
I/O Signals	Sequence Output Signals SERVOPACKs	Fixed Output	Allowable voltage range: 5 VDC to 30 VDC Number of output points: 1 Output signal: ALM (Servo Alarm) signal
		Output Signals That Can Be Allocated	Allowable voltage range: 5 VDC to 30 VDC Number of output points: 6 (A photocoupler output (isolated) is used for three of the outputs.) (An open-collector output (non-isolated) is used for the other three outputs.) Output Signals <ul style="list-style-type: none"> • /COIN (Positioning Completion) Signal • /V-CMP (Speed Coincidence Detection) Signal • /TGON (Rotation Detection) Signal • /S-RDY (Servo Ready) signal • /CLT (Torque Limit Detection) Signal • /VLT (Speed Limit Detection) Signal • /BK (Brake) signal • /WARN (Warning) Signal • /NEAR (Near) signal • /PSELA (Reference Pulse Input Multiplication Switching Output) signal • /ALO1, /ALO2, and /ALO3 (Alarm Code) signals • /POUT0 (Programmable Output 0) signal • /POUT1 (Programmable Output 1) signal • /POUT2 (Programmable Output 2) signal • /POUT3 (Programmable Output 3) signal • /POUT4 (Programmable Output 4) signal • /POSRDY (Origin Return Completed Output) signal • DEN (Position Reference Distribution Completed) signal A signal can be allocated and the positive and negative logic can be changed.
Communications	Digital Operator Communications (CN3)	Interfaces	Digital Operator (JUSP-OP05A-1-E)
		1:N Communications	Up to N = 15 stations possible for RS-422A port
	USB Communications (CN7)	Interface	Personal computer (with SigmaWin+)
		Communications Standard	Conforms to USB2.0 standard (12 Mbps).
Displays/Indicators	SERVOPACK	CHARGE indicator and five-digit seven-segment display	
	Panel Operator	Four push switches	
Operating Methods	Program Table	<ul style="list-style-type: none"> • Program table positioning in which steps are executed in sequence with commands from contact inputs • Positioning by specifying station numbers with commands from contact inputs 	
	Max. Number of Steps	256 steps (32 steps max. if input signals are used)	
	Other Functions	Registration (positioning with external signals) and origin returns.	
	Analog Monitor (CN5)	Number of points: 2 Output voltage range: ±10 VDC (effective linearity range: ±8 V) Resolution: 16 bits Accuracy: ±20 mV (Typ) Maximum output current: ±10 mA Settling time (±1%): 1.2 ms (Typ)	
	Dynamic Brake (DB)	Activated when a servo alarm or overtravel (OT) occurs, or when the power supply to the main circuit or servo is OFF.	
	Regenerative Processing	Built-in  Built-In Regenerative Resistor (page 472)	
	Overtravel (OT) Prevention	Stopping with dynamic brake, deceleration to a stop, or coasting to a stop for the P-OT (Forward Drive Prohibit) or N-OT (Reverse Drive Prohibit) signal	
	Protective Functions	Overcurrent, overvoltage, low voltage, overload, regeneration error, etc.	

Continued on next page.

SERVOPACKs

Σ-7S Single-axis FT83 SERVOPACKs SGM7D Motor Drive with built-in INDEXER

Continued from previous page.

Item		Specification			
Utility Functions		Gain adjustment, alarm history, jogging, origin search, etc.			
Safety Functions	Inputs	/HWBB1 and /HWBB2: Base block signals for Power Modules			
	Output	EDM1: Monitors the status of built-in safety circuit (fixed output).			
	Applicable Standards*3	ISO13849-1 PLe (Category 3) and IEC61508 SIL3			
Applicable Option Modules		Fully-closed Modules and Safety Modules Note: You cannot use a Fully-closed Module and a Safety Module together.			
Controls	Speed Control	Soft Start Time Setting	0 s to 10 s (Can be set separately for acceleration and deceleration.)		
		Input Signal	Reference Voltage	<ul style="list-style-type: none"> Maximum input voltage: ±12 V (forward motor rotation for positive reference). 6 VDC at rated speed (default setting). Input gain setting can be changed.	
			Input Impedance	Approx. 14 kΩ	
			Circuit Time Constant	30 μs	
		Internal Set Speed Control	Rotation Direction Selection	With Proportional Control signal	
			Speed Selection	With Forward/Reverse External Torque Limit signals (speed 1 to 3 selection). Servomotor stops or another control method is used when both signals are OFF.	
	Position Control	Feedforward Compensation		0% to 100%	
		Output Signal Positioning Completed Width Setting		0 to 1,073,741,824 reference units	
		Input Signals	Reference Pulses	Reference Pulse Form	One of the following is selected: Sign + pulse train, CW + CCW pulse trains, and two-phase pulse trains with 90° phase differential
				Input Form	Line driver or open collector
			Maximum Input Frequency	<ul style="list-style-type: none"> Line Driver Sign + pulse train or CW + CCW pulse trains: 4 Mpps Two-phase pulse trains with 90° phase differential: 1 Mpps Open Collector Sign + pulse train or CW + CCW pulse trains: 200 kpps Two-phase pulse trains with 90° phase differential: 200 kpps 	
			Input Multiplication Switching	1 to 100 times	
		Clear Signal		Position deviation clear Line driver or open collector	
	Torque Control	Input Signal	Reference Voltage	<ul style="list-style-type: none"> Maximum input voltage: ±12 V (forward torque output for positive reference). 3 VDC at rated torque (default setting). Input gain setting can be changed.	
			Input Impedance	Approx. 14 kΩ	
			Circuit Time Constant	16 μs	

*1. If you combine a Σ-7-Series SERVOPACK with a Σ-V-Series Option Module, the following Σ-V-Series SERVO-PACKs specifications must be used: a surrounding air temperature of 0°C to 55°C and an altitude of 1,000 m max. Also, the applicable surrounding range cannot be increased by derating.

*2. The coefficient of speed fluctuation for load fluctuation is defined as follows:

$$\text{Coefficient of speed fluctuation} = \frac{\text{No-load motor speed} - \text{Total-load motor speed}}{\text{Rated motor speed}} \times 100\%$$

*3. Always perform risk assessment for the system and confirm that the safety requirements are met.

Selecting Cables

◆ System Configurations

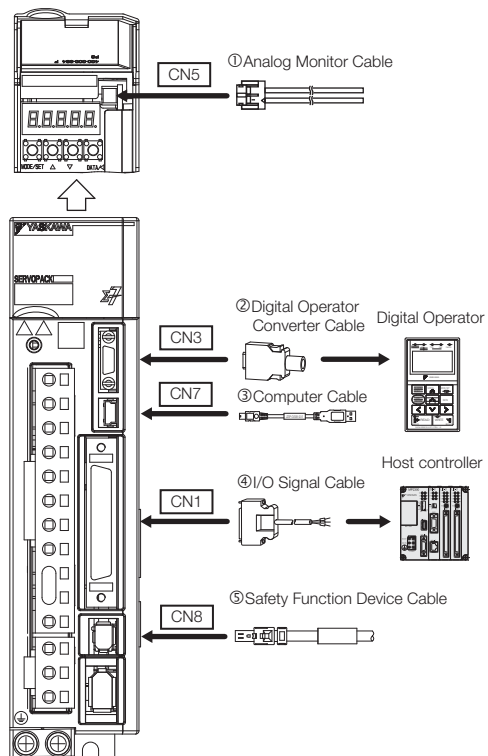

◆ Selection Table





1. Use the cable specified by Yaskawa for the Computer Cable. Operation may not be dependable with any other cable.

2. Use the cable specified by Yaskawa for the MECHATROLINK Communications Cables. Operation may not be dependable due to low noise resistance with any other cable.

Note: Refer to the following manual for the following information.

- Cable dimensional drawings and cable connection specifications
- Order numbers and specifications of individual connectors for cables

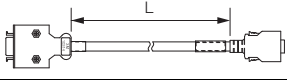
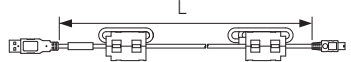
📖 *Σ-7-Series AC Servo Drive Peripheral Device Selection Manual (Manual No.: S1EP S800001 32)*

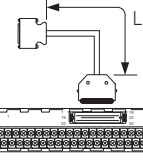
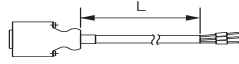
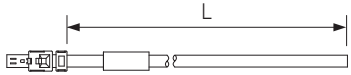
Code	Name	Length (L)	Order Number	Appearance	
①	Analog Monitor Cable	1 m	JZSP-CA01-E		
②	Digital Operator Converter Cable	0.3 m	JZSP-CVS05-A3-E*1		
③	Computer Cable	2.5 m	JZSP-CVS06-02-E		
④	I/O Signal Cables	Soldered Connector Kit		JZSP-CSI9-1-E	
		Connector-Terminal Block Converter Unit (with cable)	0.5 m	JUSP-TA50PG-E	
			1 m	JUSP-TA50PG-1-E	
			2 m	JUSP-TA50PG-2-E	
		Cable with Loose Wires at One End (loose wires on peripheral device end)	1 m	JZSP-CSI01-1-E	
			2 m	JZSP-CSI01-2-E	
3 m	JZSP-CSI01-3-E				
⑤	Safety Function Device Cables	Cables with Connectors*2	1 m	JZSP-CVH03-01-E	
			3 m	JZSP-CVH03-03-E	
		Connector Kit*3	Contact Tyco Electronics Japan G.K. Product name: Industrial Mini I/O D-shape Type 1 Plug Connector Kit Model number: 2013595-1		

*1. This Converter Cable is required to use the Σ-III-series Digital Operator (JUSP-OP05A) for Σ-7-series SERVOPACKs.

*2. When using safety functions, connect this Cable to the safety function devices.
When not using safety functions, connect the enclosed Safety Jumper Connector (JZSP-CVH05-E) to the SERVOPACK.

*3. Use the Connector Kit when you make cables yourself.

MEMO

Model Designations

SGD7W - 1R6 A 20 A 001 000 B

Σ-7 Series
Σ-7W SERVOPACKs

1st+2nd+3rd digits

4th digit

5th+6th digits

7th digit

8th+9th+10th digits

11th+12th+13th digits

14th digit

1st+2nd+3rd digits Maximum Applicable Motor Capacity per Axis

Voltage	Code	Specification
Three-phase, 200 VAC	1R6*1	0.2 kW
	2R8*1	0.4 kW
	5R5*1*2	0.75 kW
	7R6	1.0 kW

4th digit Voltage

Code	Specification
A	200 VAC

5th+6th digits Interface*3

Code	Specification
20	MECHATROLINK-III communications reference

7th digit Design Revision Order

A

8th+9th+10th digits Hardware Options Specification

Code	Specification	Applicable Models
None	Without options	All models
000	Rack-mounted	
002	Varnished	
020*4	No dynamic brake	SGD7W-1R6A to -2R8A
	External dynamic brake resistor	SGD7W-5R5A to -7R6A
700*5	HWBB option	All models

11th+12th+13th digits FT/EX Specification

Code	Specification
None	None
000	

14th digit BTO Specification*6 (Available in Japan only)

Code	Specification
None	None
B	BTO Specification

- *1. You can use these models with either a single-phase or three-phase power supply input.
- *2. If you use the Servomotor with a single-phase 200-VAC power supply input, derate the load ratio to 65%. An example is given below. If the load ratio of the first axis is 90%, use a load ratio of 40% for the second axis so that average load ratio for both axes is 65%.
 $((90\% + 40\%)/2 = 65\%)$
- *3. The same SERVOPACKs are used for both Rotary Servomotors and Linear Servomotors.
- *4. Refer to the following manual for details.
 📖 *Σ-7-Series AC Servo Drive Σ-7S/Σ-7W SERVOPACK with Hardware Option Specifications Dynamic Brake Product Manual* (Manual No.: SIEP S800001 73)
- *5. Refer to the following manual for details.
 📖 *Σ-7-Series AC Servo Drive Σ-7W/Σ-7C SERVOPACK with Hardware Option Specifications HWBB Function Product Manual* (Manual No.: SIEP S800001 72)
- *6. The BTO specification indicates if the SERVOPACK is customized by using the MechatroCloud BTO service. You need a BTO number to order SERVOPACKs with customized specifications. Refer to page M-15 for the details on the BTO service.

Ratings and Specifications

Ratings

◆ Three-phase, 200 VAC

Model SGD7W-		1R6A	2R8A	5R5A	7R6A	
Maximum Applicable Motor Capacity per Axis [kW]		0.2	0.4	0.75	1.0	
Continuous Output Current per Axis [Arms]		1.6	2.8	5.5	7.6	
Instantaneous Maximum Output Current per Axis [Arms]		5.9	9.3	16.9	17.0	
Main Circuit	Power Supply	200 VAC to 240 VAC, -15% to +10%, 50 Hz/60 Hz				
	Input Current [Arms]*	2.5	4.7	7.8	11	
Control	Power Supply	200 VAC to 240 VAC, -15% to +10%, 50 Hz/60 Hz				
	Input Current [Arms]*	0.25	0.25	0.25	0.25	
Power Supply Capacity [kVA]*		1.0	1.9	3.2	4.5	
Power Loss*	Main Circuit Power Loss [W]	24.0	43.3	78.9	94.2	
	Control Circuit Power Loss [W]	17	17	17	17	
	Built-in Regenerative Resistor Power Loss [W]	8	8	16	16	
	Total Power Loss [W]	49	68	112	127	
Regenerative Resistor	Built-In Regenerative Resistor	Resistance [Ω]	40	40	12	12
		Capacity [W]	40	40	60	60
	Minimum Allowable External Resistance [Ω]	40	40	12	12	
Overvoltage Category		III				

* This is the net value at the rated load.

◆ Single-phase, 200 VAC

Model SGD7W-		1R6A	2R8A	5R5A* ¹	
Maximum Applicable Motor Capacity per Axis [kW]		0.2	0.4	0.75	
Continuous Output Current per Axis [Arms]		1.6	2.8	5.5	
Instantaneous Maximum Output Current per Axis [Arms]		5.9	9.3	16.9	
Main Circuit	Power Supply	200 VAC to 240 VAC, -15% to +10%, 50 Hz/60 Hz			
	Input Current [Arms]* ²	5.5	11	12	
Control	Power Supply	200 VAC to 240 VAC, -15% to +10%, 50 Hz/60 Hz			
	Input Current [Arms]* ²	0.25	0.25	0.25	
Power Supply Capacity [kVA]* ²		1.3	2.4	2.7	
Power Loss* ²	Main Circuit Power Loss [W]	24.1	43.6	54.1	
	Control Circuit Power Loss [W]	17	17	17	
	Built-in Regenerative Resistor Power Loss [W]	8	8	16	
	Total Power Loss [W]	49	69	87	
Regenerative Resistor	Built-In Regenerative Resistor	Resistance [Ω]	40	40	12
		Capacity [W]	40	40	60
	Minimum Allowable External Resistance [Ω]	40	40	12	
Overvoltage Category		III			

*1. If you use the SGD7W-5R5A with a single-phase 200-VAC power supply input, derate the load ratio to 65%. An example is given below.

If the load ratio of the first axis is 90%, use a load ratio of 40% for the second axis so that average load ratio for both axes is 65% ((90% + 40%)/2 = 65%).

*2. This is the net value at the rated load. However, a load ratio of 65% was used for the SGD7W-5R5A.

SERVOPACKs

Σ-7W Two-axis MECHATROLINK-III Communications Reference SERVOPACKs

◆ 270 VDC

Model SGD7W-		1R6A	2R8A	5R5A	7R6A
Maximum Applicable Motor Capacity [kW]		0.2	0.4	0.75	1.0
Continuous Output Current [Arms]		1.6	2.8	5.5	7.6
Instantaneous Maximum Output Current [Arms]		5.9	9.3	16.9	17.0
Main Circuit	Power Supply	270 VDC to 324 VDC, -15% to +10%			
	Input Current [Arms]*	3.0	5.8	9.7	14
Control	Power Supply	270 VDC to 324 VDC, -15% to +10%			
	Input Current [Arms]*	0.25	0.25	0.25	0.25
Power Supply Capacity [kVA]*		1.2	2	3.2	4.6
Power Loss*	Main Circuit Power Loss [W]	18.7	33.3	58.4	73.7
	Control Circuit Power Loss [W]	17	17	17	17
	Total Power Loss [W]	36	50	75	91
Overvoltage Category		III			

* This is the net value at the rated load.

SERVOPACK Overload Protection Characteristics

The overload detection level is set for hot start conditions with a SERVOPACK surrounding air temperature of 55°C.

An overload alarm (A.710 or A.720) will occur if overload operation that exceeds the overload protection characteristics shown in the following diagram (i.e., operation on the right side of the applicable line) is performed.

The actual overload detection level will be the detection level of the connected SERVOPACK or Servomotor that has the lower overload protection characteristics.

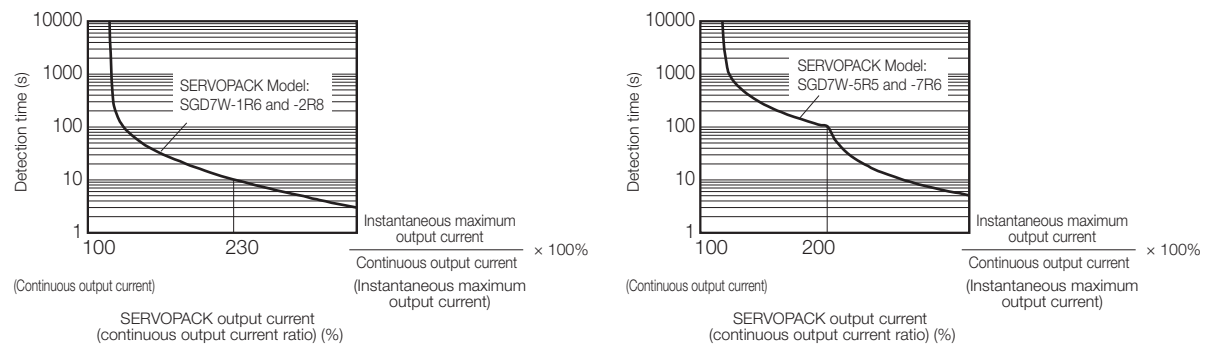

In most cases, that will be the overload protection characteristics of the Servomotor.



Note: The above overload protection characteristics do not mean that you can perform continuous duty operation with an output of 100% or higher.

For a Yaskawa-specified combination of SERVOPACK and Servomotor, maintain the effective torque (or effective force) within the continuous duty zone of the torque-motor speed characteristic (or force-motor speed characteristics) of the Servomotor.

Specifications

Item		Specification
Control Method		IGBT-based PWM control, sine wave current drive
Feedback	With Rotary Servomotor	Serial encoder: 17 bits (absolute encoder) 20 bits or 24 bits (incremental encoder/absolute encoder) 22 bits (absolute encoder)
	With Linear Servomotor	<ul style="list-style-type: none"> Absolute linear encoder (The signal resolution depends on the absolute linear encoder.) Incremental linear encoder (The signal resolution depends on the incremental linear encoder or Serial Converter Unit.)
Environmental Conditions	Surrounding Air Temperature	-5°C to 55°C With derating, usage is possible between 55°C and 60°C. Refer to the following section for derating specifications.  <i>Derating Specifications (page 417)</i>
	Storage Temperature	-20°C to 85°C
	Surrounding Air Humidity	95% relative humidity max. (with no freezing or condensation)
	Storage Humidity	95% relative humidity max. (with no freezing or condensation)
	Vibration Resistance	4.9 m/s ²
	Shock Resistance	19.6 m/s ²
	Degree of Protection	IP20
	Pollution Degree	2 <ul style="list-style-type: none"> Must be no corrosive or flammable gases. Must be no exposure to water, oil, or chemicals. Must be no dust, salts, or iron dust.
	Altitude	1,000 m or less. With derating, usage is possible between 1,000 m and 2,000 m. Refer to the following section for derating specifications.  <i>Derating Specifications (page 417)</i>
	Others	Do not use the SERVOPACK in the following locations: Locations subject to static electricity noise, strong electromagnetic/magnetic fields, or radioactivity
Applicable Standards		UL 61800-5-1 (E147823), CSA C22.2 No.274, EN 55011 group 1 class A, EN 61000-6-2, EN 61000-6-4, EN 61800-3 (Category C2, Second environment), EN 50178, and EN 61800-5-1
Mounting		Base-mounted or rack-mounted
Performance	Speed Control Range	1:5000 (At the rated torque, the lower limit of the speed control range must not cause the Servomotor to stop.)
	Coefficient of Speed Fluctuation*	±0.01% of rated speed max. (for a load fluctuation of 0% to 100%)
		0% of rated speed max. (for a voltage fluctuation of ±10%)
		±0.1% of rated speed max. (for a temperature fluctuation of 25°C ±25°C)
	Torque Control Precision (Repeatability)	±1%
Soft Start Time Setting	0 s to 10 s (Can be set separately for acceleration and deceleration.)	

Continued on next page.

SERVOPACKs

Σ-7W Two-axis MECHATROLINK-III Communications Reference SERVOPACKs

Continued from previous page.

Item		Specification	
I/O Signals	Overheat Protection Input	Number of input points: 2 Input voltage range: 0 V to +5 V	
	Sequence Input Signals	Input Signals That Can Be Allocated	
		Input Signals That Can Be Allocated	Allowable voltage range: 24 VDC ±20% Number of input points: 12 Input method: Sink inputs or source inputs Input Signals <ul style="list-style-type: none"> • P-OT (Forward Drive Prohibit) and N-OT (Reverse Drive Prohibit) signals • /P-CL (Forward External Torque Limit) and /N-CL (Reverse External Torque Limit) signals • /DEC (Origin Return Deceleration Switch) signal • /EXT1 to /EXT3 (External Latch Input 1 to 3) signals • FSTP (Forced Stop Input) signal A signal can be allocated and the positive and negative logic can be changed.
	Sequence Output Signals	Fixed Output	Allowable voltage range: 5 VDC to 30 VDC Number of output points: 2 Output signal: Servo Alarm (ALM)
Output Signals That Can Be Allocated		Allowable voltage range: 5 VDC to 30 VDC Number of output points: 5 (A photocoupler output (isolated) is used.) Output Signals <ul style="list-style-type: none"> • /COIN (Positioning Completion) signal • /V-CMP (Speed Coincidence Detection) signal • /TGON (Rotation Detection) signal • /S-RDY (Servo Ready) signal • /CLT (Torque Limit Detection) signal • /VLT (Speed Limit Detection) signal • /BK (Brake) signal • /WARN (Warning) signal • /NEAR (Near) signal A signal can be allocated and the positive and negative logic can be changed.	
Communications	RS-422A Communications (CN3)	Interfaces	Digital Operator (JUSP-OP05A-1-E) and personal computer (with SigmaWin+)
		1:N Communications	Up to N = 15 stations possible for RS-422A port
		Axis Address Settings	03 to EF hex (maximum number of slaves: 62) The rotary switches (S1 and S2) are used to set the station address.
	USB Communications (CN7)	Interface	Personal computer (with SigmaWin+)
Communications Standard		Conforms to USB2.0 standard (12 Mbps).	
Displays/Indicators		CHARGE, PWR, CN, L1, and L2 indicators, and two, one-digit seven-segment displays	
MECHATROLINK-III Communications	Communications Protocol	MECHATROLINK-III	
	Station Address Settings	03 to EF hex (maximum number of slaves: 62) The rotary switches (S1 and S2) are used to set the station address.	
	Extended Address Setting	Axis 1: 00 hex, Axis 2: 01 hex	
	Baud Rate	100 Mbps	
	Transmission Cycle	250 μs, 500 μs, 750 μs, 1.0 ms to 4.0 ms (multiples of 0.5 ms)	
	Number of Transmission Bytes	32 or 48 bytes/station A DIP switch (S3) is used to select the baud rate.	
Reference Method	Performance	Position, speed, or torque control with MECHATROLINK-III communications	
	Reference Input	MECHATROLINK-III commands (sequence, motion, data setting, data access, monitoring, adjustment, etc.)	
	Profile	MECHATROLINK-III standard servo profile	
MECHATROLINK-III Communications Setting Switches		Rotary switch (S1 and S2) positions: 16 Number of DIP switch (S3) pins: 4	

Continued on next page.

Continued from previous page.

Item	Specification
Analog Monitor (CN5)	Number of points: 2 Output voltage range: ±10 VDC (effective linearity range: ±8 V) Resolution: 16 bits Accuracy: ±20 mV (Typ) Maximum output current: ±10 mA Settling time (±1%): 1.2 ms (Typ)
Dynamic Brake (DB)	Activated when a servo alarm or overtravel (OT) occurs, or when the power supply to the main circuit or servo is OFF.
Regenerative Processing	Built-in
Overtravel (OT) Prevention	Stopping with dynamic brake, deceleration to a stop, or coasting to a stop for the P-OT (Forward Drive Prohibit) or N-OT (Reverse Drive Prohibit) signal
Protective Functions	Overcurrent, overvoltage, low voltage, overload, regeneration error, etc.
Utility Functions	Gain adjustment, alarm history, jogging, origin search, etc.
Option Module	Option Module cannot be attached.

* The coefficient of speed fluctuation for load fluctuation is defined as follows:

$$\text{Coefficient of speed fluctuation} = \frac{\text{No-load motor speed} - \text{Total-load motor speed}}{\text{Rated motor speed}} \times 100\%$$

Derating Specifications

If you use the SERVOPACK at a surrounding air temperature of 55°C to 60°C or at an altitude of 1,000 m to 2,000 m, you must apply the derating rates given in the following graphs.

◆ SGD7W-1R6A, -2R8A, -5R5A, and -7R6A

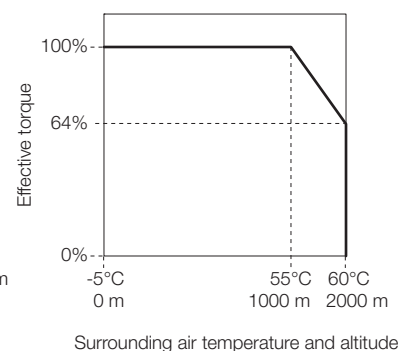
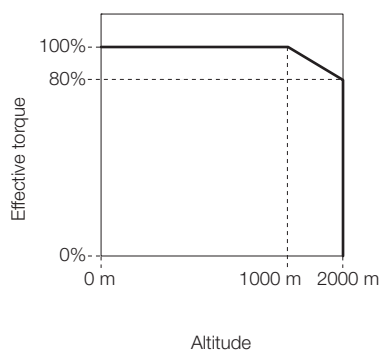
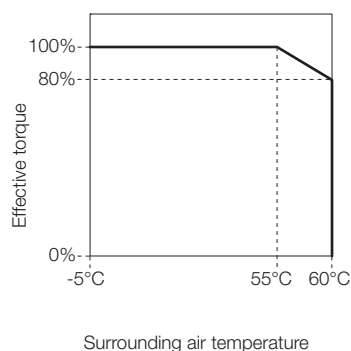

Selecting Cables

◆ System Configurations

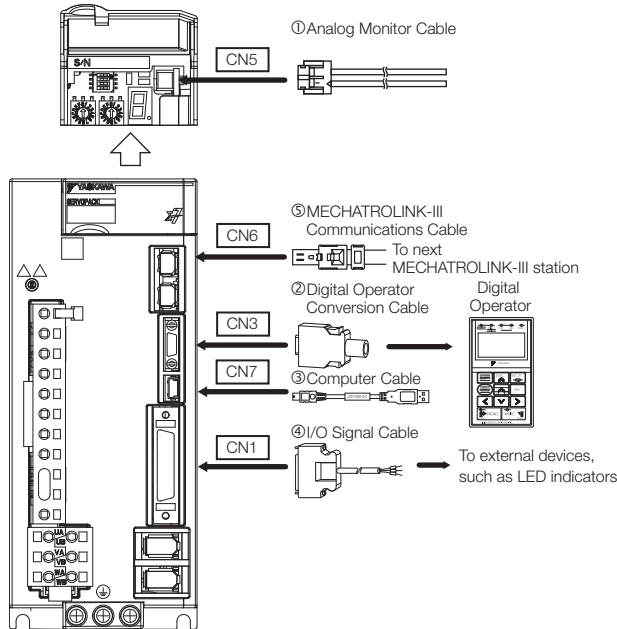

◆ Selection Table

Important

1. Use the cable specified by Yaskawa for the Computer Cable. Operation may not be dependable with any other cable.
2. Use the cable specified by Yaskawa for the MECHATROLINK Communications Cables. Operation may not be dependable due to low noise resistance with any other cable.

Note: Refer to the following manual for the following information.

- Cable dimensional drawings and cable connection specifications
 - Order numbers and specifications of individual connectors for cables
- 📖 *Σ-7-Series AC Servo Drive Peripheral Device Selection Manual (Manual No.: SIEP S800001 32)*

Code	Name	Length (L)	Order Number	Appearance
①	Analog Monitor Cable	1 m	JZSP-CA01-E	
②	Digital Operator Converter Cable	0.3 m	JZSP-CVS05-A3-E*1	
			JZSP-CVS07-A3-E*2	
③	Computer Cable	2.5 m	JZSP-CVS06-02-E	

Continued on next page.

Continued from previous page.

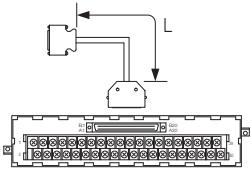
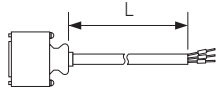
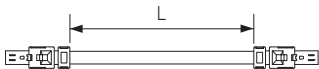
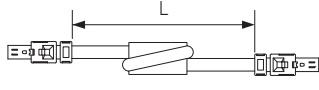
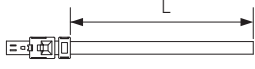
Code	Name	Length (L)	Order Number	Appearance	
④	I/O Signal Cables	Soldered Connector Kit	DP9420007-E		
		Connector-Terminal Block Converter Unit (with cable)	0.5 m	JUSP-TA36P-E	
			1 m	JUSP-TA36P-1-E	
			2 m	JUSP-TA36P-2-E	
		Cable with Loose Wires at One End (loose wires on peripheral device end)	1 m	JZSP-CSI03-1-E	
			2 m	JZSP-CSI03-2-E	
			3 m	JZSP-CSI03-3-E	
⑤	MECHATROLINK-III Communications Cables	Cables with Connectors on Both Ends	0.2 m	JEPMC-W6012-A2-E	
			0.5 m	JEPMC-W6012-A5-E	
			1 m	JEPMC-W6012-01-E	
			2 m	JEPMC-W6012-02-E	
			3 m	JEPMC-W6012-03-E	
			4 m	JEPMC-W6012-04-E	
			5 m	JEPMC-W6012-05-E	
			10 m	JEPMC-W6012-10-E	
			20 m	JEPMC-W6012-20-E	
			30 m	JEPMC-W6012-30-E	
	50 m	JEPMC-W6012-50-E			
	Cables with Connectors on Both Ends (with core)	10 m	JEPMC-W6013-10-E		
		20 m	JEPMC-W6013-20-E		
		30 m	JEPMC-W6013-30-E		
		50 m	JEPMC-W6013-50-E		
	Cable with Loose Wires at One End	0.5 m	JEPMC-W6014-A5-E		
		1 m	JEPMC-W6014-01-E		
		3 m	JEPMC-W6014-03-E		
		5 m	JEPMC-W6014-05-E		
		10 m	JEPMC-W6014-10-E		
		30 m	JEPMC-W6014-30-E		
50 m	JEPMC-W6014-50-E				

*1. This Converter Cable is required to use the Σ-III-series Digital Operator (JUSP-OP05A) for Σ-7-series SERVOPACKs.

*2. If you use a MECHATROLINK-III Communications Reference SERVOPACK, this Converter Cable is required to prevent the cable from disconnecting from the Digital Operator.

Σ-7C Two-axis Bus Connection Reference SERVOPACKs with built-in Controllers

Model Designations

SGD7C - 1R6 A MA A 001

Σ-7 Series
Σ-7C SERVOPACKs

1st+2nd+3rd
digits

4th
digit

5th+6th
digits

7th
digit

8th+9th+10th
digits

1st+2nd+3rd digits Maximum Applicable
Motor Capacity per Axis

Voltage	Code	Specification
Three- phase, 200 VAC	1R6 ^{*1}	0.2 kW
	2R8 ^{*1}	0.4 kW
	5R5 ^{*1*2}	0.75 kW
	7R6	1.0 kW

4th digit Voltage

Code	Specification
A	200 VAC

5th+6th digits Interface^{*3}

Code	Specification
MA	Bus connection references

7th digit Design Revision Order

A

8th+9th+10th digits Hardware Options
Specification

Code	Specification	Applicable Models
None	Without options	All models
000		
001		
002	Rack-mounted	
	Varnished	
020 ^{*4}	No dynamic brake	SGD7C-1R6A to -2R8A
	External dynamic brake resistor	SGD7C-5R5A to -7R6A
700 ^{*5}	HWBB option	All models

*1. You can use these models with either a single-phase or three-phase power supply input.

*2. If you use the Servomotor with a single-phase 200-VAC power supply input, derate the load ratio to 65%.

An example is given below. If the load ratio of the first axis is 90%, use a load ratio of 40% for the second axis so that average load ratio for both axes is 65%.

$$((90\% + 40\%)/2 = 65\%)$$

*3. The same SERVOPACKs are used for both Rotary Servomotors and Linear Servomotors.

*4. Refer to the following manual for details.

📖 *Σ-7-Series AC Servo Drive Σ-7S/Σ-7W SERVOPACK with Hardware Option Specifications Dynamic Brake Product Manual* (Manual No.: SIEP S800001 73)

*5. Refer to the following manual for details.

📖 *Σ-7-Series AC Servo Drive Σ-7W/Σ-7C SERVOPACK with Hardware Option Specifications HWBB Function Product Manual* (Manual No.: SIEP S800001 72)

Ratings and Specifications

Ratings

◆ Three-phase, 200 VAC

Model SGD7C-		1R6A	2R8A	5R5A	7R6A	
Maximum Applicable Motor Capacity per Axis [kW]		0.2	0.4	0.75	1.0	
Continuous Output Current per Axis [Arms]		1.6	2.8	5.5	7.6	
Instantaneous Maximum Output Current per Axis [Arms]		5.9	9.3	16.9	17.0	
Main Circuit	Power Supply	200 VAC to 240 VAC, -15% to +10%, 50 Hz/60 Hz				
	Input Current [Arms]*	2.5	4.7	7.8	11	
Control	Power Supply	200 VAC to 240 VAC, -15% to +10%, 50 Hz/60 Hz				
	Input Current [Arms]*	0.25	0.25	0.25	0.25	
Power Supply Capacity [kVA]*		1.0	1.9	3.2	4.5	
Power Loss*	Main Circuit Power Loss [W]	24.0	43.3	78.9	94.2	
	Control Circuit Power Loss [W]	17	17	17	17	
	Built-in Regenerative Resistor Power Loss [W]	8	8	16	16	
	Total Power Loss [W]	49	68	112	127	
Regenerative Resistor	Built-In Regenerative Resistor	Resistance [Ω]	40	40	12	12
		Capacity [W]	40	40	60	60
	Minimum Allowable External Resistance [Ω]	40	40	12	12	
Overvoltage Category		III				

* This is the net value at the rated load.

◆ Single-phase, 200 VAC

Model SGD7C-		1R6A	2R8A	5R5A* ¹	
Maximum Applicable Motor Capacity per Axis [kW]		0.2	0.4	0.75	
Continuous Output Current per Axis [Arms]		1.6	2.8	5.5	
Instantaneous Maximum Output Current per Axis [Arms]		5.9	9.3	16.9	
Main Circuit	Power Supply	200 VAC to 240 VAC, -15% to +10%, 50 Hz/60 Hz			
	Input Current [Arms]* ²	5.5	11	12	
Control	Power Supply	200 VAC to 240 VAC, -15% to +10%, 50 Hz/60 Hz			
	Input Current [Arms]* ²	0.25	0.25	0.25	
Power Supply Capacity [kVA]* ²		1.3	2.4	2.7	
Power Loss* ²	Main Circuit Power Loss [W]	24.1	43.6	54.1	
	Control Circuit Power Loss [W]	17	17	17	
	Built-in Regenerative Resistor Power Loss [W]	8	8	16	
	Total Power Loss [W]	49	69	87	
Regenerative Resistor	Built-In Regenerative Resistor	Resistance [Ω]	40	40	12
		Capacity [W]	40	40	60
	Minimum Allowable External Resistance [Ω]	40	40	12	
Overvoltage Category		III			

*1. If you use the SGD7C-5R5A with a single-phase 200-VAC power supply input, derate the load ratio to 65%. An example is given below.

If the load ratio of the first axis is 90%, use a load ratio of 40% for the second axis so that average load ratio for both axes is 65% ((90% + 40%)/2 = 65%).

*2. This is the net value at the rated load. However, a load ratio of 65% was used for the SGD7W-5R5A.

SERVOPACK Overload Protection Characteristics

The overload detection level is set for hot start conditions with a SERVOPACK surrounding air temperature of 55°C.

An overload alarm (A.710 or A.720) will occur if overload operation that exceeds the overload protection characteristics shown in the following diagram (i.e., operation on the right side of the applicable line) is performed.

The actual overload detection level will be the detection level of the connected SERVOPACK or Servomotor that has the lower overload protection characteristics.

In most cases, that will be the overload protection characteristics of the Servomotor.

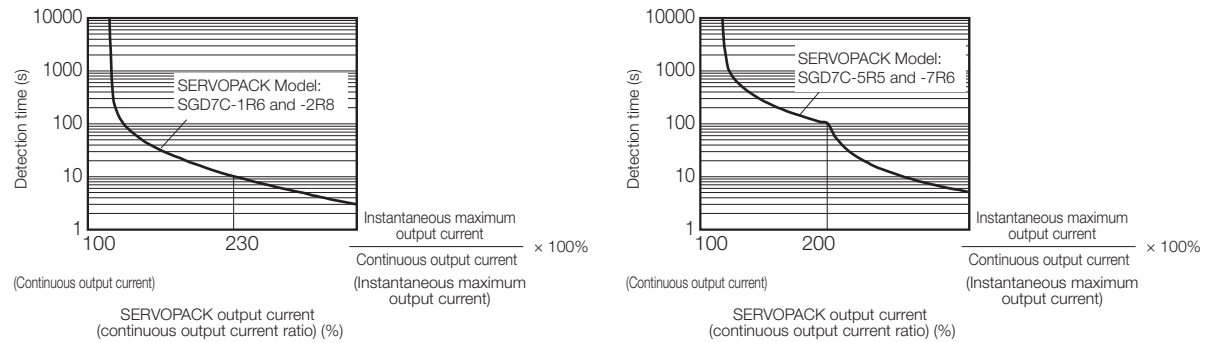

Note: The above overload protection characteristics do not mean that you can perform continuous duty operation with an output of 100% or higher.

For a Yaskawa-specified combination of SERVOPACK and Servomotor, maintain the effective torque (or effective force) within the continuous duty zone of the torque-motor speed characteristic (or force-motor speed characteristics) of the Servomotor.

General Specifications

Item		Specification
Control Method		IGBT-based PWM control, sine wave current drive
Feedback	With Rotary Servo-motor	Serial encoder: 17 bits (absolute encoder) 20 bits or 24 bits (incremental encoder/absolute encoder) 22 bits (absolute encoder)
	With Linear Servo-motor	<ul style="list-style-type: none"> Absolute linear encoder (The signal resolution depends on the absolute linear encoder.) Incremental linear encoder (The signal resolution depends on the incremental linear encoder or Serial Converter Unit.)
Environmental Conditions	Surrounding Air Temperature	0°C to 55°C
	Storage Temperature	-20°C to 85°C
	Surrounding Air Humidity	10% to 95% relative humidity (with no freezing or condensation)
	Storage Humidity	10% to 95% relative humidity (with no freezing or condensation)
	Vibration Resistance	4.9 m/s ²
	Shock Resistance	19.6 m/s ²
	Protection Class	IP20
	Pollution Degree	2 <ul style="list-style-type: none"> Must be no corrosive or flammable gases. Must be no exposure to water, oil, or chemicals. Must be no excessive dust, salts, or iron dust.
	Altitude	1,000 m max. Note: With derating, usage is possible between 1,000 m and 2,000 m. Refer to the following section for the derating specifications.  Derating Specifications (page 424)
	Power Frequency Magnetic Field	30 A/m (50 Hz/60 Hz), IEC 61000-4-8, Level 4
Others	Must be no exposure to electrostatic noise or radiation.	
Applicable Standards		UL 61800-5-1 (E147823), CSA C22.2 No.274, EN 55011 group 1 class A, EN 61000-6-2, EN 61000-6-4, EN 61800-3 (Category C2, Second environment), EN 50178, and EN 61800-5-1
Mounting		Base-mounted or rack-mounted

Derating Specifications

If you use the SERVOPACK at an altitude of 1,000 m to 2,000 m, you must apply the derating rates given in the following graph.

◆ SGD7C-1R6A, -2R8A, -5R5A, and -7R6A

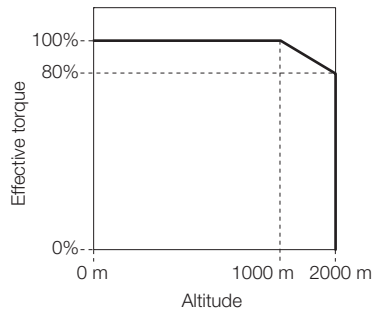

Servo Section Specifications

Item		Specification	
Performance	Speed Control Range	1:5000 (At the rated torque, the lower limit of the speed control range must not cause the Servomotor to stop.)	
	Coefficient of Speed Fluctuation*	±0.01% of rated speed max. (for a load fluctuation of 0% to 100%)	
		0% of rated speed max. (for a load fluctuation of ±10%)	
		±0.1% of rated speed max. (for a temperature fluctuation of 25°C ±25°C)	
Torque Control Precision (Repeatability)	±1%		
Soft Start Time Setting	0 s to 10 s (Can be set separately for acceleration and deceleration.)		
I/O Signals	Overheat Protection Input	Number of input points: 2 Input voltage range (0 V to 5 V)	
	Sequence Input Signals	Input Signals That Can Be Allocated	Allowable voltage range: 24 VDC ±20% Number of input points: 12 Input method: Sink inputs or source inputs Input Signals: <ul style="list-style-type: none"> • P-OT (Forward Drive Prohibit Input) and N-OT (Reverse Drive Prohibit Input) signals • /P-CL (Forward External Torque Limit) and /N-CL (Reverse External Torque Limit) signals • /DEC (Origin Return Deceleration Switch) signal • /EXT1 to /EXT3 (External Latch Input 1 to 3) signals • FSTP (Forced Stop Input) signal A signal can be allocated and the positive and negative logic can be changed.
		Sequence Output Signals	Fixed Outputs
	Output Signals That Can Be Allocated		Allowable voltage range: 5 VDC to 30 VDC Number of outputs points: 5 (Photocoupler outputs (isolated) are used.) Output Signals: <ul style="list-style-type: none"> • /COIN (Positioning Completion) signal • /V-CMP (Speed Coincidence Detection) signal • /TGON (Rotation Detection) signal • /S-RDY (Servo Ready) signal • /CLT (Torque Limit Detection) signal • /VLT (Speed Limit Detection) signal • /BK (Brake) signal • /WARN (Warning) signal • /NEAR (Near) signal A signal can be allocated and the positive and negative logic can be changed.
Communications	USB Communications (CN7)	Interface	Personal computer (with SigmaWin+)
		Communications Standard	Conforms to USB2.0 standard (12 Mbps).
Displays/Indicators		CHARGE and PWR indicators, and two, one-digit seven-segment displays	
Reference Method		Reference with built-in controller	
Dynamic Brake (DB)		Activated when a servo alarm or overtravel (OT) occurs, or when the power supply to the main circuit or servo is OFF.	
Regenerative Processing		Built-in	
Overtravel (OT) Prevention		Stopping with dynamic brake, deceleration to a stop, or coasting to a stop for the P-OT (Forward Drive Prohibit Input) or N-OT (Reverse Drive Prohibit Input) signal	
Protective Functions		Overcurrent, overvoltage, undervoltage, overload, regeneration error, etc.	
Utility Functions		Gain adjustment, alarm history, jogging, origin search, etc.	
Applicable Option Modules		None	

* The coefficient of speed fluctuation for load fluctuation is defined as follows:

$$\text{Coefficient of speed fluctuation} = \frac{\text{No-load motor speed} - \text{Total-load motor speed}}{\text{Rated motor speed}} \times 100\%$$

Controller Section Specifications

This section provides the specifications of the Controller Section.

◆ Hardware Specifications

Item	Specification
Flash Memory	Capacity: 24 MB (15 MB of user memory)
SDRAM	Capacity: 256 MB
MRAM	Capacity: 4 MB
Calendar	Seconds, minutes, hour, day, week, month, year, day of week, and timing
Ethernet	One port, 10Base-T or 100Base-TX
MECHATROLINK	<ul style="list-style-type: none"> • MECHATROLINK-III, 1 circuit with 1 port • Master
USB	<ul style="list-style-type: none"> • USB 2.0, Type A host, 1 port • Compatible devices: USB storage
Indicators and Displays	<ul style="list-style-type: none"> • Seven-segment display • Status indicators • USB Status Indicator • Ethernet status indicators
Switches	<ul style="list-style-type: none"> • DIP switches: Mode switches • STOP/SAVE switch
Connectors	<ul style="list-style-type: none"> • MECHATROLINK-III connector (CN6) • USB connector (CN10) • Ethernet connector (CN12) • Controller Section I/O connector (CN13)

◆ Performance Specifications

	Item	Specification	Remarks
Number of Controlled Axes	SVC4	4 axes 1 circuit	Circuit number selected from 1 to 16.
	SVD	2 axes	Circuit number selected from 1 to 16.
	SVR4	4 axes 1 circuit	Circuit number selected from 1 to 16.
	Maximum Number of Controlled Axes	6 axes	–
Scan Time Settings	H Scan	0.5 ms to 32.0 ms (in 0.25-ms increments)	Refer to the following manual for details. 📖 <i>Σ-7-Series Σ-7C SERVOPACK Product Manual</i> (Manual No.: SIEP S800002 04)
	L Scan	2.0 ms to 300 ms (in 0.5-ms increments)	–
	H Scan Default	4 ms	–
	L Scan Default	200 ms	–
Peripheral Devices	Calendar	Supported.	–
	Communications Interface	Ethernet	–
	USB	Supported.	–
Memory Capacity	DRAM	256 MB with ECC	–
	MRAM	4 MB	Up to 1 MB can be used to back up table data.
	Program Capacity	15 MB	Total capacity including definition data, ladder programs, table data, etc.
Ladder Programs	Number of Startup Drawings (DWG.A)	64	Number of steps per drawing: 4,000
	Number of Interrupt Drawings (DWG.I)	64	
	Number of High-Speed Scan Drawings (DWG.H)	1000	
	Number of Low-Speed Scan Drawings (DWG.L)	2000	
	Number of User Function Drawings	2000	
Motion Programs	Number of Programs	512	Total of all programs listed below: • Motion main programs • Motion subprograms • Sequence main programs • Sequence subprograms
	Number of Groups	16	–
	Number of Tasks	32	–
	Number of Nesting Levels for IF Instructions	8	–
	Number of Nesting Levels for MSEE Instructions	8	–
	Number of Parallel Forks Per Task	8	Select from the following four options: • Main: 4 forks, Sub: 2 forks • Main: 8 forks • Main: 2 forks, Sub: 4 forks • Sub: 8 forks
	Number of Simultaneously Controlled Axes Per Task	10 axes	–

Continued on next page.

SERVOPACKs
Σ-7C Two-axis Bus Connection Reference SERVOPACKs with built-in Controllers



Continued from previous page.

Item		Specification	Remarks	
Registers	S Registers	64 Kwords	–	
	M Registers	1 Mword	–	
	G Registers	2 Mwords	–	
	I/O Registers	64 Kwords	–	
	Motion Registers	32 Kwords	–	
	C Registers	16 Kwords	–	
	# Registers	16 Kwords	–	
	D Registers	16 Kwords	–	
Data Types	Bit (B)	Supported.	0 or 1	
	Integer (W)	Supported.	-32,768 to 32,767	
	Double-Length Integer (L)	Supported.	-2,147,483,648 to 2,147,483,647	
	Quadruple-Length Integer (Q)	Supported.	-9,223,372,036,854,775,808 to 9,223,372,036,854,775,807	
	Single-Precision Real Number (F)	Supported.	± (1.175E-38 to 3.402E+38) or 0	
	Double-Precision Real Number (D)	Supported.	±(2.225E-308 to 1.798E+308) or 0	
	Addresses (A)	Supported.	0 to 16,777,214	
Index Registers	Subscript i	Supported.	Special registers for offsetting addresses. Subscripts i and j function identically.	
	Subscript j	Supported.		
	Array Registers	Supported.	Used to handle registers as arrays.	
Data Tracing	Number of Groups	4	–	
	Trace Memory	256 Kwords total in 4 groups	–	
	Traceable Data Points	16 points per group	–	
	Trigger Types	>, <, =, <>, >=, <= and differential detection of the above conditions	–	
Data Logging	Number of Groups	4	–	
	Log Storage Location	Built-in RAM disk or USB memory device	–	
	Log File Formats	CSV file format or binary file format	–	
	Data Logging Points	64 points per group	–	
	Number of Log Files	Built-in RAM Disk	1 to 4,000	–
		USB Memory	1 to 32,767 or unlimited	The ultimate upper limit is 10,000 files even if unlimited is selected.
	Trigger Types	>, <, =, <>, >=, <=	–	

◆ Communications Function Module Specifications

Item		Specification	Remarks	
Abbreviation		218IFD		
Common Items	Transmission Interface	10Base-T/100Base-TX	–	
	Number of Communications Ports (Connectors)	1	–	
	Transmission Protocols	TCP/UDP/IP/ARP/ICMP/IGMP	–	
Ethernet Communications	Maximum Number of Communications Connections	20 + 2 (I/O message communications)	–	
	Maximum Number of Communications Channels	10 + 2 (I/O message communications)	–	
	Automatic Reception	Supported.	Not supported for no-protocol communications.	
	Maximum Number of Automatic Reception Connections	10	–	
	Automatic Reception Status Monitor	Supported.	–	
	Maximum Size of Message Communications	MEMOBUS	Write: 100 words Read: 125 words	–
		Extended MEMOBUS	Write: 2,043 words Read: 2,044 words	–
		MELSEC (A-Compatible 1E)	Write: 256 words Read: 256 words	–
		MELSEC (QnA-Compatible 3E)	Write: 960 words Read: 960 words	–
		MODBUS/TCP	Write: 100 words Read: 125 words	–
		OMRON	Write: 996 words Read: 999 words	–
		TOYOPUC	Write: 1,022 words	–
		No-protocol	Write: 2,046 words	–
	Maximum Size of I/O Message Communications	MEMOBUS	Write: 100 words Read: 125 words	–
		Extended MEMOBUS	Write: 1,024 words Read: 1,024 words	–
		MELSEC (A-Compatible 1E)	Write: 256 words Read: 256 words	–
		MELSEC (QnA-Compatible 3E)	Write: 256 words Read: 256 words	–
		MODBUS/TCP	Write: 100 words Read: 125 words	–
		OMRON	Write: 996 words Read: 999 words	–
		Execution Conditions	You can select controls (start/stop) from a ladder program.	–
Execution Status Monitor		Supported.	–	
MotomanSync-MP		Supported.	–	
FTP Server		Supported.	–	
FTP Client		Supported.	–	
Receive Buffer Mode Selection for No-protocol Communications		Supported.	–	
Engineering Tools	Communications Platform	Ethernet	–	
	Controller Searches	Supported.	–	
	Supported Engineering Tools	MPE720 Ver.7 and SigmaWin+ Ver.7	–	

◆ Motion Control Function Module Specifications

Module	Item	Specification	
SVD	Number of Controlled Axes*1	2	
	Reference Update Cycle (High-Speed Scan Cycle Performed by the CPU)	500 μs to 32.0 ms	
	Register Ranges	Registers for two axes are assigned from the registers for each circuit. Refer to the following manual for details.  Σ-7-Series Σ-7C SERVOPACK Motion Control User's Manual (Manual No.: SIEP S800002 03)	
SVC4	Number of Controlled Axes*1	4	
	Reference Update Cycle (High-Speed Scan Cycle Performed by the CPU)	500 μs to 32.0 ms	
	Register Ranges	Registers for four axes are assigned from the registers for each circuit. Refer to the following manuals for details.  Σ-7-Series Σ-7C SERVOPACK Motion Control User's Manual (Manual No.: SIEP S800002 03)	
	MECHATROLINK-III communications	Communications Interface	Master
		Communications Cycle (Reference Update Cycle)	500 μs to 32.0 ms
		Transmission Cycle*2	125 μs, 250 μs, 500 μs, or 1 ms
		Communications Cable	MECHATROLINK-III Communications Cable
		Maximum Number of Connectable Stations	8
		Topology	Cascade connections, star connections, or mixed star-cascade connections
		Terminating Resistance	Not required.
Connectable Slave Devices		SERVOPACKs, Stepping Motor Drivers, Inverters, I/O Modules, and Machine Controllers that support MECHATROLINK-III communications	
Supported Profiles	MECHATROLINK-III Servo Standard, MECHATROLINK-III I/O Standard, MECHATROLINK-III Inverter Standard, and MECHATROLINK-III Stepping Motor Standard		
SVR4	Number of Controlled Axes*1	4	
	Reference Update Cycle (High-Speed Scan Cycle Performed by the CPU)	500 μs to 32.0 ms	
	Register Ranges	Registers for four axes are assigned from the registers for each circuit. Refer to the following manuals for details.  Σ-7-Series Σ-7C SERVOPACK Motion Control User's Manual (Manual No.: SIEP S800002 03)	

*1. A maximum of six axes can be controlled with the Motion Control Function Module in a Σ-7C SERVOPACK. Do not control more than a total of six axes with one Motion Control Function Module.

*2. The transmission cycle is the cycle in which the SVC4 and the slave devices perform communications on the MECHATROLINK-III transmission path.

◆ M-EXECUTOR Specifications

■ Registerable Programs

Program Type		Number of Registered Programs
Motion Programs		32*
Sequence Programs	Startup	1
	Interrupt	Not possible.
	H scan	32*
	L scan	32*



* The combined total of motion programs and sequence programs must not exceed 32.

■ Program Control Methods

You can use the following control methods for the programs that are registered in the M-EXECUTOR:

Item	Motion Programs	Sequence Programs										
Execution Method	Sequential execution	Startup: Event execution H scan: Scan execution L scan: Scan execution										
System Work	The same number is used for the definition number and system work number.											
	<table border="1"> <thead> <tr> <th>Definition No.</th> <th>System Work Number</th> </tr> </thead> <tbody> <tr> <td>No.1</td> <td>1</td> </tr> <tr> <td>No.2</td> <td>2</td> </tr> <tr> <td>⋮</td> <td>⋮</td> </tr> <tr> <td>No.32</td> <td>32</td> </tr> </tbody> </table>		Definition No.	System Work Number	No.1	1	No.2	2	⋮	⋮	No.32	32
Definition No.	System Work Number											
No.1	1											
No.2	2											
⋮	⋮											
No.32	32											
Program Designation Method	Direct designation or indirect designation	Direct designation										
Program Execution Method	Register the program in the definitions and start execution by turning ON the start signal.	Execution is started when the program is registered in the definitions.										
Interpolation Override Setting	Supported.	Not supported.										
I/O Link Definitions	Supported.	Not supported.										
Motion Program Status Reporting in S Registers	Supported.											
Number of Parallel Forks	Up to 8 Main: 4 forks, Sub: 2 forks Main: 8 forks Main: 2 forks, Sub:4 forks Sub: 8 forks	No forks										
Error Diagram Execution When an Operation Error Occurs	Supported.											

◆ USB Memory Specifications

Item	Specification	Remarks
Supported Media	USB memory device	Refer to the following section for details.  ■ Recommended USB Memory Device (page 431)
Applicable FAT	FAT16/32	–
Maximum Number of Nested Directories	10	–
File Information	Last update timestamp supported.	Uses the calendar in the Controller Section. Refer to the following manual for details.  Σ-7-Series Σ-7C SERVOPACK Product Manual (Manual No.: SIEP S800002 04)
Maximum Length for File Name and Directory Names	256 characters	–
Current Directory Function	16	–
Maximum Number of Simultaneously Open Files	16	–
Formatting	Not supported.	Use a formatted USB memory device.

■ Recommended USB Memory Device

The following USB memory device is recommended. It can be purchased from Yaskawa.

Model	Specification	Manufacturer
SFU24096D1BP1TO-C-QT-111-CAP	4-GB USB memory	Swissbit Japan Inc.

◆ IO16 Function Module Specifications

The following table gives the specifications of the IO16 Function Module. There are 16 digital inputs and 16 digital outputs in the IO16 Function Module.

Item	Specification	
Digital Inputs	Number of Inputs	16
	Input Method	Sink/source
	Isolation Method	Photocouplers
	Input Voltage	24 VDC \pm 20%
	Input Current	5 mA (typical)
	ON Voltage/Current	15 V min./2 mA min.
	OFF Voltage/Current	5 V max./1 mA max.
	ON/OFF Time	0.01 ms + Digital filter setting
	Digital Filter Setting	0 to 65,535 μ s
	Number of Commons	2 (8 points per common)
	Others	DI_00 is also used for interrupt signals. DI_01 is also used as the pulse latch input.
Digital Outputs	Number of Outputs	16
	Output Method	Transistor open-collector sink outputs
	Isolation Method	Photocouplers
	Output Voltage	24 VDC (20 V to 30 V)
	Output Current	50 mA max.
	Leakage Current When OFF	0.1 mA max.
	ON/OFF Time	0.01 μ s (for output current of 85 mA)
	Number of Commons	2 (8 points per common)
	Output Protection	Thermistor (automatic recovery after blow out)
	Others	DO_00 is also used as the Match Output.

◆ Counter Specifications

The following table gives the specifications of counter. The counter uses a pulse input on one channel.

Item	Specification	
Pulse Input	Number of Inputs	1 (phase A, B, or Z input)
	Input Circuits	Phases A and B: 5-V differential input, not isolated, maximum frequency: 4 MHz Phase Z: 5-V, 12-V, or 24-V photocoupler input, maximum frequency: 500 kHz
	Input Modes	Phases A and B, sign, and incrementing/decrementing
	Latch Input	Pulses are latched for phase Z or DI_01. Response Times for Phase-Z Input ON: 1 μ s max. OFF: 1 μ s max. Response Times for DI_01 Input ON: 60 μ s max. OFF: 0.5 ms max.
	Other Functions	Match detection, counter preset and clear, electronic gear conversion, phase-C (phase-Z), and digital filter

◆ System Register Specifications

This section shows the overall structure of the system registers.

Refer to the following manuals for details.

📖 *Σ-7-Series Σ-7C SERVOPACK Product Manual* (Manual No.: SIEP S800002 04)

📖 *Σ-7-Series Σ-7C SERVOPACK Troubleshooting Manual* (Manual No.: SIEP S800002 07)

Register Addresses	Contents
SW00000 to SW00029	System Service Registers
SW00030 to SW00049	System Status
SW00050 to SW00079	System Error Status
SW00080 to SW00089	User Operation Error Status
SW00090 to SW00103	System Service Execution Status
SW00104 to SW00109	Reserved.
SW00110 to SW00189	Detailed User Operation Error Status
SW00190 to SW00199	Reserved.
SW00200 to SW00503	System I/O Error Status
SW00504 and SW00505	Reserved.
SW00506 and SW00507	Security Status
SW00508 to SW00649	Reserved.
SW00650 to SW00667	USB-Related System Status
SW00668 to SW00693	Reserved.
SW00694 to SW00697	Message Relaying Status
SW00698 to SW00789	Interrupt Status
SW00790 to SW00799	Reserved.
SW00800 to SW01095	Module Information
SW01096 to SW02687	Reserved.
SW02688 to SW03199	PROFINET Controller (266IF-01) IOPS Status
SW03200 to SW05119	Motion Program Information
SW05120 to SW05247	Used by the system (system memory read).
SW05248 to SW08191	Reserved.
SW08192 to SW09215	Expansion Motion Program Information
SW09216 to SW09559	Reserved.
SW09560 to SW10627	Expansion System I/O Error Status
SW10628 to SW13699	Reserved.
SW13700 to SW14259	Expanded Unit and Module Information
SW14260 to SW15997	Reserved.
SW15998 to SW16011	Expansion System Service Execution Status
SW16012 to SW16199	Reserved.
SW16200 to SW17999	Alarm History Information
SW18000 to SW19999	Reserved.
SW20000 to SW22063	Product Information
SW22064 to SW23999	Reserved.
SW24000 to SW24321	Data Logging Execution Status
SW24322 to SW24999	Reserved.
SW24400 to SW24719	FTP Client Status and Controls
SW25000 to SW25671	Automatic Reception Status for Ethernet Communications
SW25672 to SW27599	Reserved.
SW27600 to SW29775	Maintenance Monitor
SW29776 to SW65534	Reserved.

Selecting Cables

◆ System Configurations

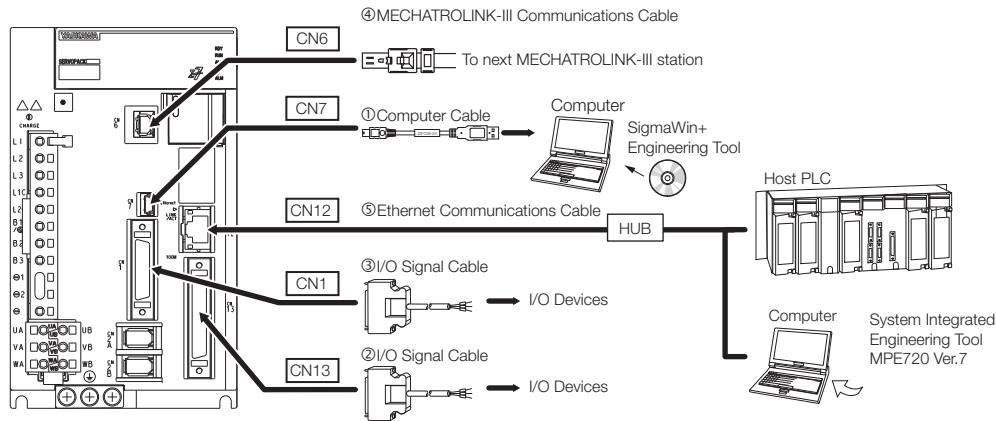

◆ Selection Table

Important

1. Use the cable specified by Yaskawa for the Computer Cable. Operation may not be dependable with any other cable.
2. Use the cable specified by Yaskawa for the MECHATROLINK Communications Cables. Operation may not be dependable due to low noise resistance with any other cable.

Note: Refer to the following manual for the following information.

- Cable dimensional drawings and cable connection specifications
- Order numbers and specifications of individual Device connectors for cables

📖 *Σ-7-Series AC Servo Drive Peripheral Device Selection Manual (Manual No.: SIEP S800001 32)*

Code	Name	Length (L)	Order Number	Appearance	
①	Computer Cable	2.5 m	JZSP-CVS06-02-E		
②	I/O Signal Cables	Soldered Connector Kit		DP9420007-E	
		Connector-Terminal Block Converter Unit (with cable)	0.5 m	JUSP-TA36P-E	
			1 m	JUSP-TA36P-1-E	
			2 m	JUSP-TA36P-2-E	
		Cable with Loose Wires at One End (loose wires on peripheral device end)	1 m	JZSP-CSI03-1-E	
			2 m	JZSP-CSI03-2-E	
3 m	JZSP-CSI03-3-E				

Continued on next page.

Continued from previous page.

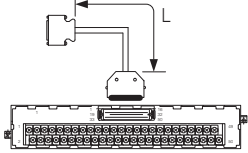
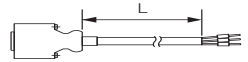
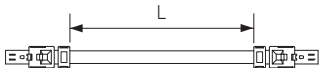
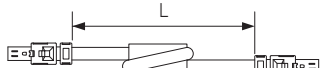
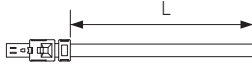
Code	Name	Length (L)	Order Number	Appearance	
③	I/O Signal Cables	Soldered Connector Kit	JZSP-CSI9-1-E		
		Connector-Terminal Block Converter Unit (with cable)	0.5 m	JUSP-TA50PG-E	
			1 m	JUSP-TA50PG-1-E	
			2 m	JUSP-TA50PG-2-E	
		Cable with Loose Wires at One End (loose wires on peripheral device end)	1 m	JZSP-CSI01-1-E	
			2 m	JZSP-CSI01-2-E	
3 m	JZSP-CSI01-3-E				
④	MECHATRO LINK-III Communications Cables	Cables with Connectors on Both Ends	0.2 m	JEPMC-W6012-A2-E	
			0.5 m	JEPMC-W6012-A5-E	
			1 m	JEPMC-W6012-01-E	
			2 m	JEPMC-W6012-02-E	
			3 m	JEPMC-W6012-03-E	
			4 m	JEPMC-W6012-04-E	
			5 m	JEPMC-W6012-05-E	
			10 m	JEPMC-W6012-10-E	
			20 m	JEPMC-W6012-20-E	
		30 m	JEPMC-W6012-30-E		
		50 m	JEPMC-W6012-50-E		
		Cables with Connectors on Both Ends (with core)	10 m	JEPMC-W6013-10-E	
			20 m	JEPMC-W6013-20-E	
			30 m	JEPMC-W6013-30-E	
			50 m	JEPMC-W6013-50-E	
		Cable with Loose Wires at One End	0.5 m	JEPMC-W6014-A5-E	
			1 m	JEPMC-W6014-01-E	
			3 m	JEPMC-W6014-03-E	
5 m	JEPMC-W6014-05-E				
10 m	JEPMC-W6014-10-E				
30 m	JEPMC-W6014-30-E				
50 m	JEPMC-W6014-50-E				
⑤	Ethernet communications cables		Use a commercially available cable that meets the following conditions: <ul style="list-style-type: none"> • Ethernet specification: 100Base-TX • Category 5 or higher • Twisted-pair cable with RJ-45 connectors 		

SERVOPACK External Dimensions

Front Cover Dimensions and Connector Specifications

The front cover dimensions and panel connectors depend on the SERVOPACK interface. Refer to the following figures.

Front Cover Dimensions

- Σ -7S Analog Voltage/Pulse Train Reference SERVOPACKs

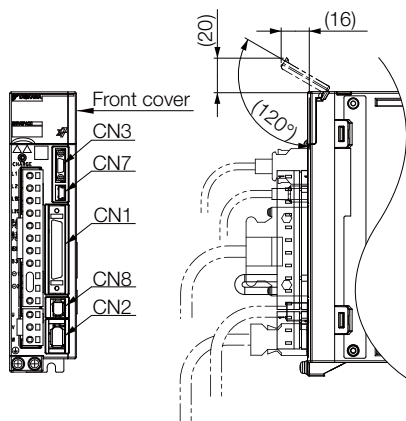

- Σ -7S MECHATROLINK-II Communications Reference SERVOPACKs

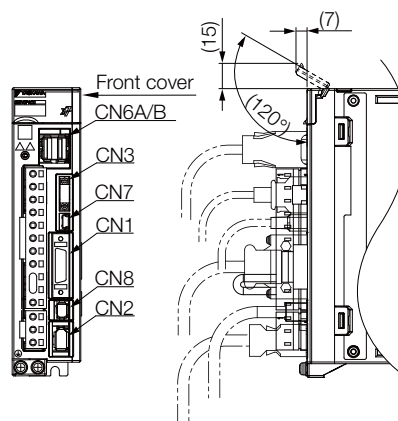

- Σ -7S MECHATROLINK-III Communications Reference SERVOPACKs

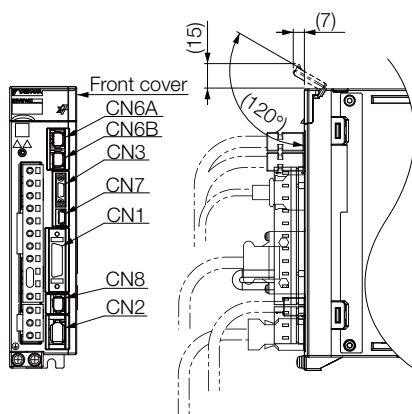

- Σ -7W MECHATROLINK-III Communications Reference SERVOPACKs

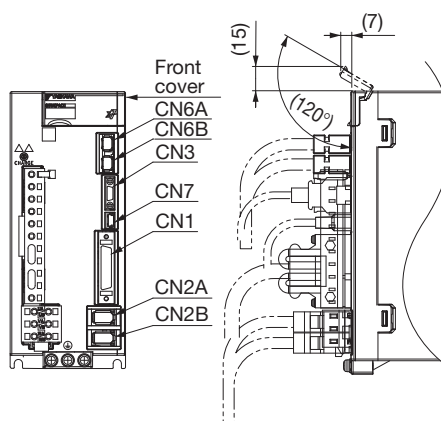

- Σ -7S Command Option Attachable-Type SERVOPACKs*

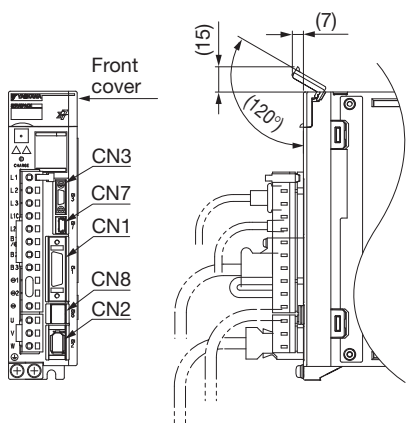

- Σ -7C Bus Connection Reference SERVOPACKs

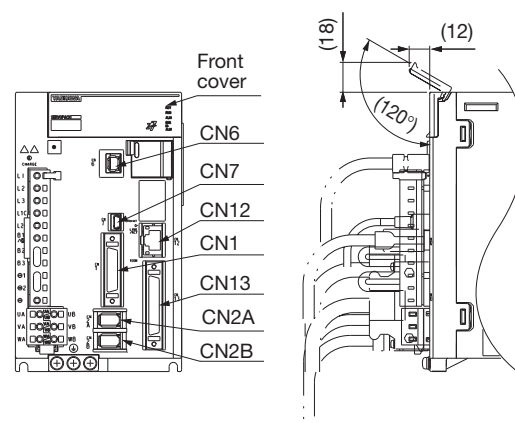

* A Command Option Module must be attached to the Command Option Attachable-Type SERVOPACK. To find the dimensions of the SERVOPACK with a Command Option Module attached, add the dimensions of the Command Option Module (refer to page 447 and following pages).

Connector Specifications

SERVOPACK	Connector No.	Model	Number of Pins	Manufacturer
Σ-7S Analog Voltage/Pulse Train Reference SERVOPACK	CN1	10250-59A3MB	50	3M Japan Ltd.
	CN2	3E106-0220KV	6	3M Japan Ltd.
	CN3	HDR-EC14LFDTN- SLD-PLUS	14	Honda Tsushin Kogyo Co., Ltd.
	CN7	2172034-1	5	Tyco Electronics Japan G.K.
	CN8	1981080-1	8	Tyco Electronics Japan G.K.
Σ-7S MECHATROLINK-II Communications Reference SERVOPACK	CN1	10226-59A3MB	26	3M Japan Ltd.
	CN2	3E106-0220KV	6	3M Japan Ltd.
	CN3	HDR-EC14LFDTN- SLD-PLUS	14	Honda Tsushin Kogyo Co., Ltd.
	CN6A/B	1903815-1	8	Tyco Electronics Japan G.K.
	CN7	2172034-1	5	Tyco Electronics Japan G.K.
Σ-7S MECHATROLINK-III Communications Reference SERVOPACK	CN8	1981080-1	8	Tyco Electronics Japan G.K.
	CN1	10226-59A3MB	26	3M Japan Ltd.
	CN2	3E106-0220KV	6	3M Japan Ltd.
	CN3	HDR-EC14LFDTN- SLD-PLUS	14	Honda Tsushin Kogyo Co., Ltd.
	CN6A, CN6B	1981386-1	8	Tyco Electronics Japan G.K.
	CN7	2172034-1	5	Tyco Electronics Japan G.K.
Σ-7S Command Option Attachable-Type SERVO- PACK	CN8	1981080-1	8	Tyco Electronics Japan G.K.
	CN1	10226-59A3MB	26	3M Japan Ltd.
	CN2	3E106-0220KV	6	3M Japan Ltd.
	CN3	HDR-EC14LFDTN- SLD-PLUS	14	Honda Tsushin Kogyo Co., Ltd.
	CN7	2172034-1	5	Tyco Electronics Japan G.K.
Σ-7W MECHATROLINK-III Communications Reference SERVOPACK	CN8	1981080-1	8	Tyco Electronics Japan G.K.
	CN1	10236-59A3MB	36	3M Japan Ltd.
	CN2A, CN2B	3E106-2230KV	6	3M Japan Ltd.
	CN3	HDR-EC14LFDTN- SLD-PLUS	14	Honda Tsushin Kogyo Co., Ltd.
	CN6A, CN6B	1981386-1	8	Tyco Electronics Japan G.K.
Σ-7C Bus Connection Reference SERVOPACK	CN7	2172034-1	5	Tyco Electronics Japan G.K.
	CN1	10236-59A3MB	36	3M Japan Ltd.
	CN2A, CN2B	3E106-2230KV	6	3M Japan Ltd.
	CN6	1981386-1	8	Tyco Electronics Japan G.K.
	CN7	2172034-1	5	Tyco Electronics Japan G.K.
	CN12	26-51024KB13-1	8	UDE Corp.
	CN13	10250-52A3PL	50	3M Japan Ltd.

Note: The above connectors or their equivalents are used for the SERVOPACKs.

SERVOPACK External Dimensions

Σ-7S SERVOPACKs: Base-mounted

All of the dimensional drawings show Analog Voltage/Pulse Train Reference SERVOPACKs as typical examples.

◆ Three-phase, 200 VAC: SGD7S-R70A, -R90A, and -1R6A

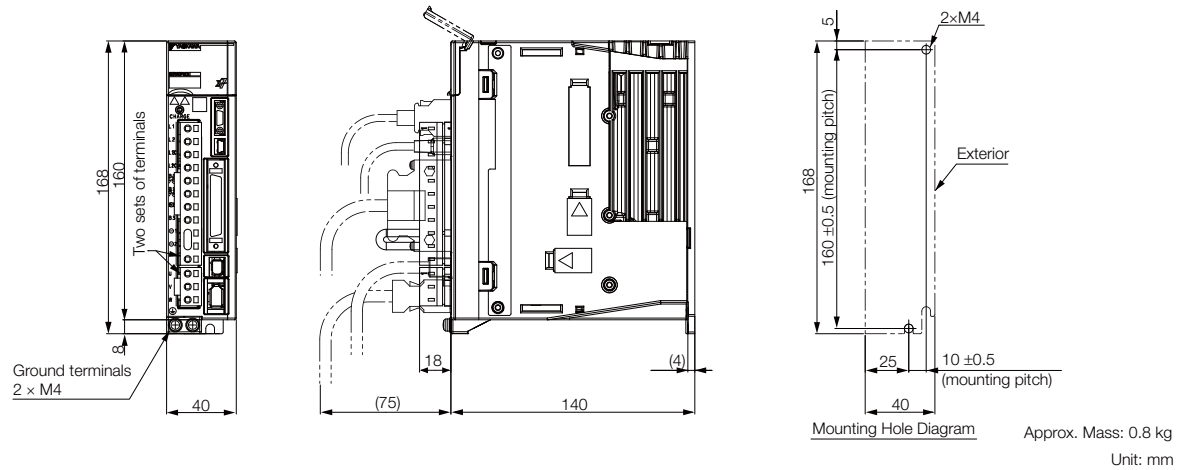

◆ Three-phase, 200 VAC: SGD7S-2R8A Single-phase, 100 VAC: SGD7S-R70F, -R90F, and -2R1F

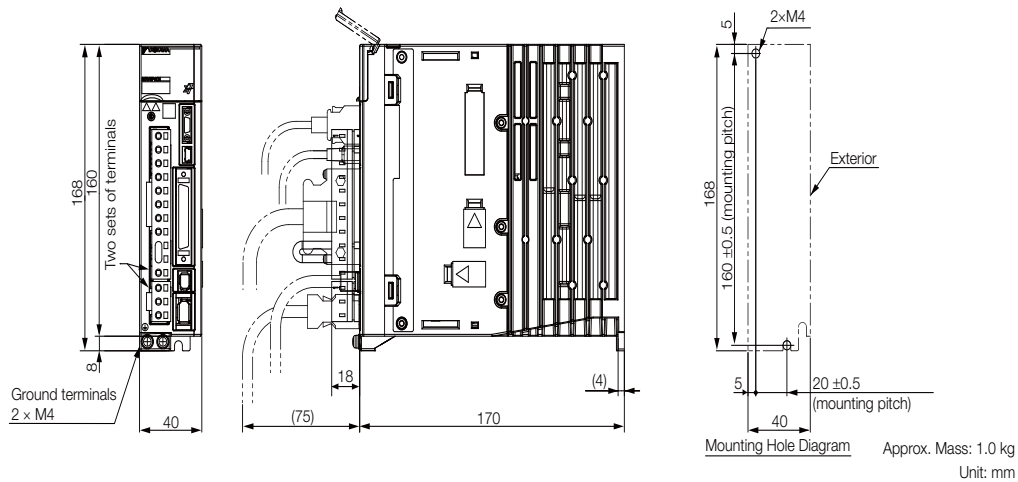

◆ Three-phase, 200 VAC: SGD7S-3R8A, -5R5A, and -7R6A Single-phase, 100 VAC: SGD7S-2R8F

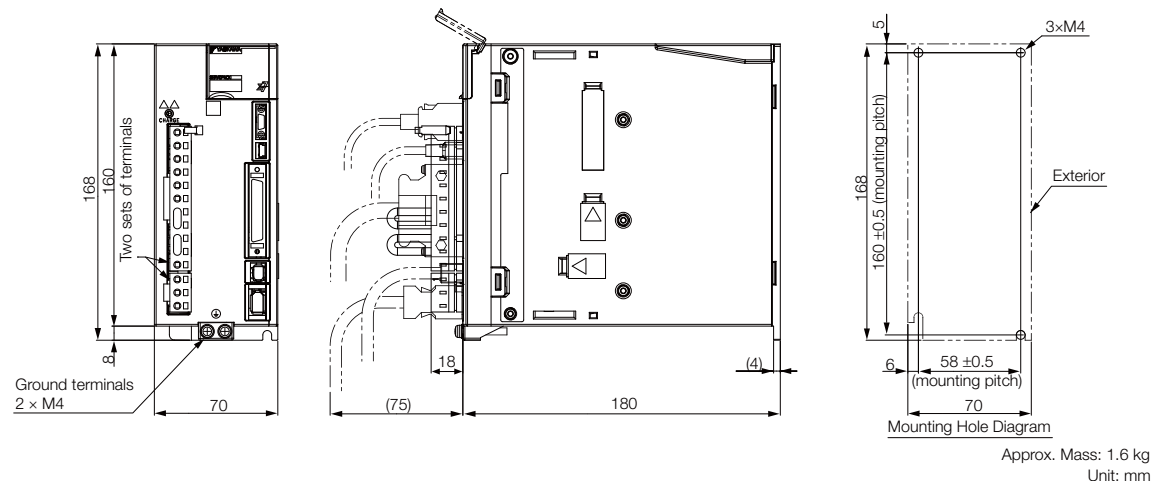

◆ Three-phase, 200 VAC: SGD7S-120A

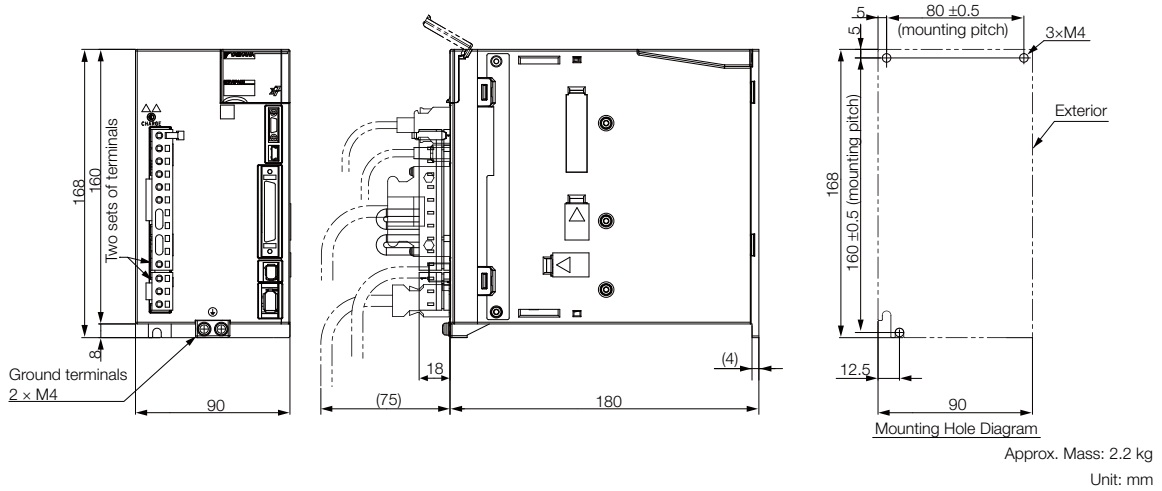

◆ Three-phase, 200 VAC: SGD7S-180A and -200A
Single-phase, 200 VAC: SGD7S-120A□□A008

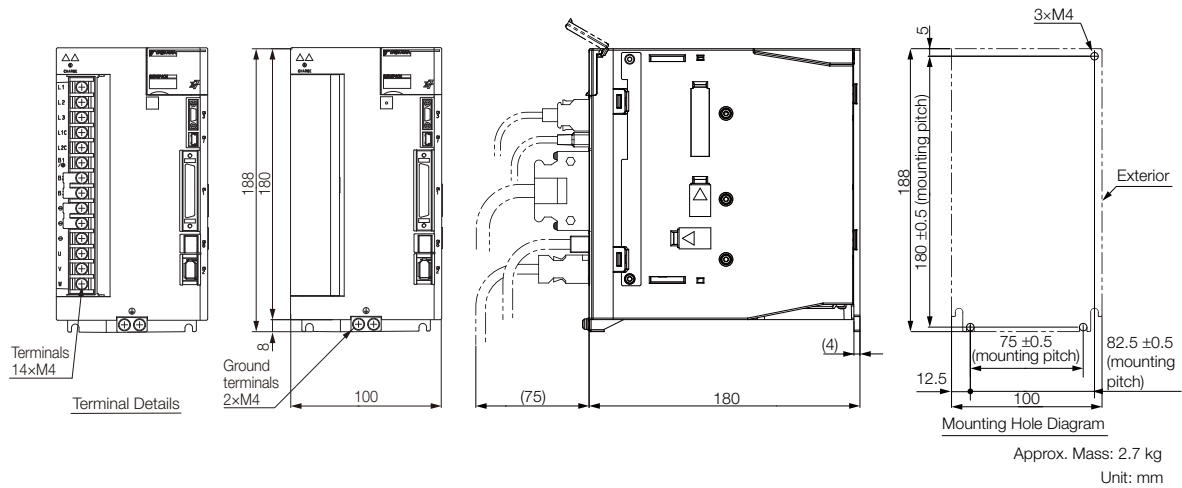

◆ Three-phase, 200 VAC: SGD7S-330A

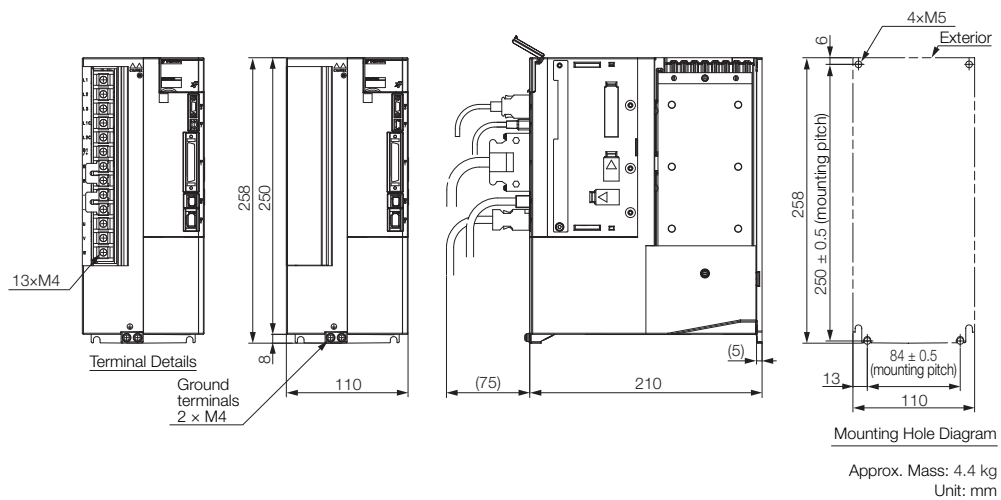

◆ Three-phase, 200 VAC: SGD7S-470A and -550A

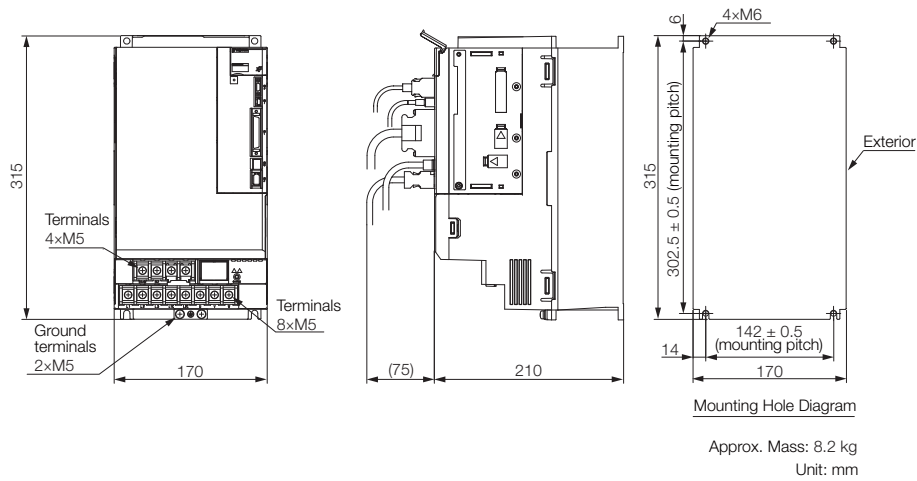

◆ Three-phase, 200 VAC: SGD7S-590A and -780A

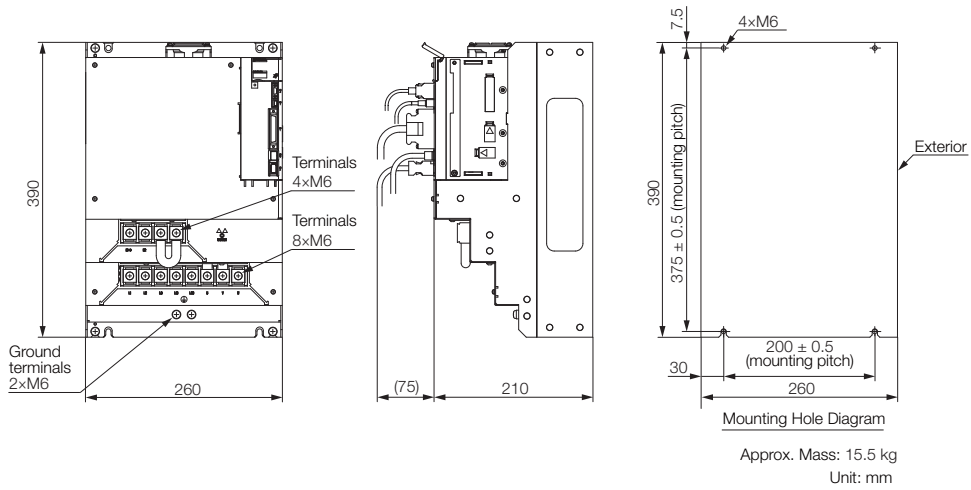

Σ-7S SERVOPACKs: Rack-mounted

Hardware Option Code: 001

All of the dimensional drawings show Analog Voltage/Pulse Train Reference SERVOPACKs as typical examples.

◆ Three-phase, 200 VAC: SGD7S-R70A, -R90A, and -1R6A

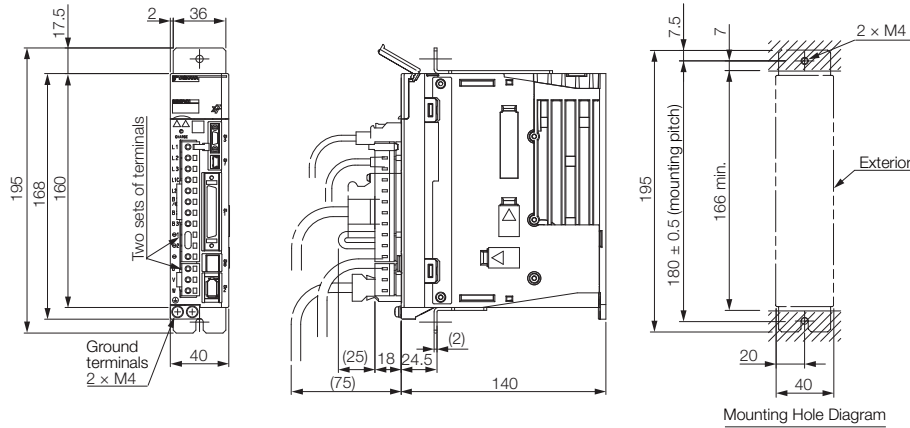

Approx. mass: 0.8 kg
Unit: mm

◆ Three-phase, 200 VAC: SGD7S-2R8A Single-phase, 100 VAC: SGD7S-R70F, -R90F, and -2R1F

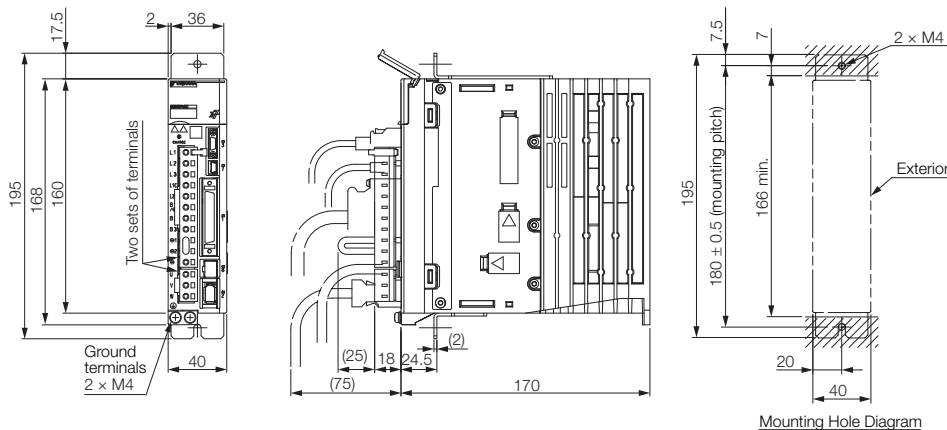

Approx. mass: 1.0 kg
Unit: mm

◆ Three-phase, 200 VAC: SGD7S-3R8A, -5R5A, and -7R6A Single-phase, 100 VAC: SGD7S-2R8F

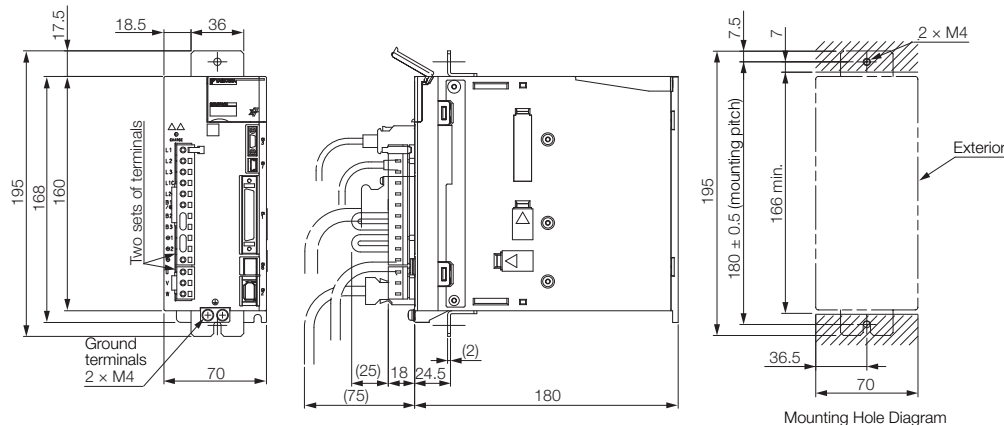

Approx. mass: 1.6 kg
Unit: mm

◆ Three-phase, 200 VAC: SGD7S-120A

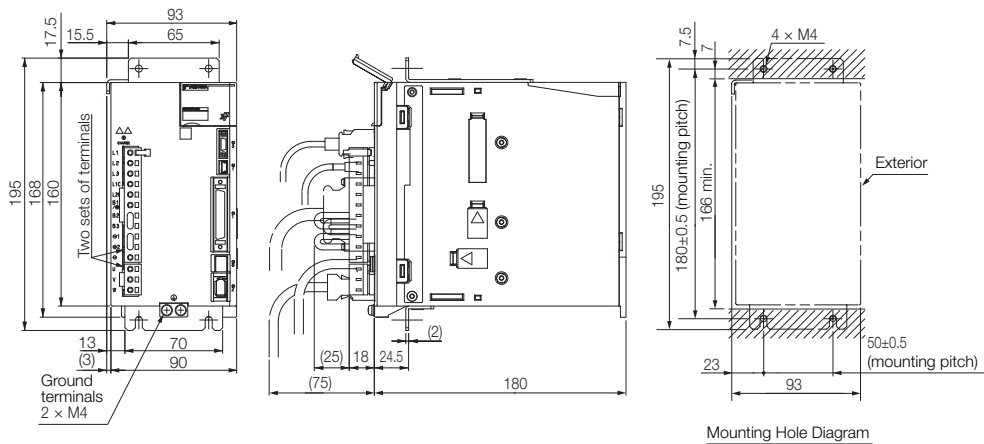

Approx. mass: 2.2 kg
Unit: mm

◆ Three-phase, 200 VAC: SGD7S-180A and -200A

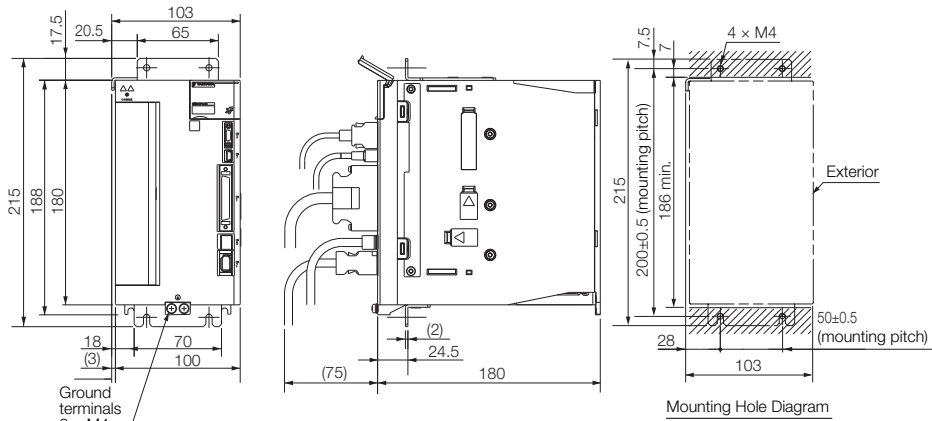

Approx. mass: 2.7 kg
Unit: mm

◆ Three-phase, 200 VAC: SGD7S-330A

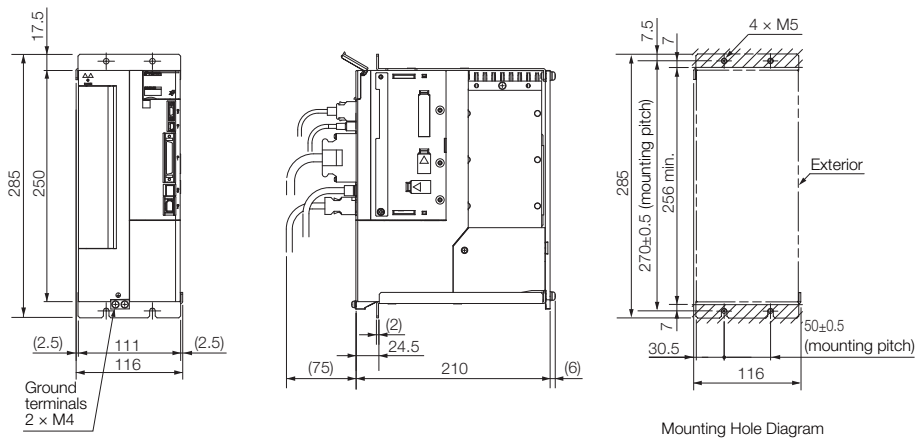

Approx. mass: 4.9 kg
Unit: mm

Σ-7S SERVOPACKs: Duct-ventilated

Hardware Option Code: 001

All of the dimensional drawings show Analog Voltage/Pulse Train Reference SERVOPACKs as typical examples.

◆ Three-phase, 200 VAC: SGD7S-470A and -550A

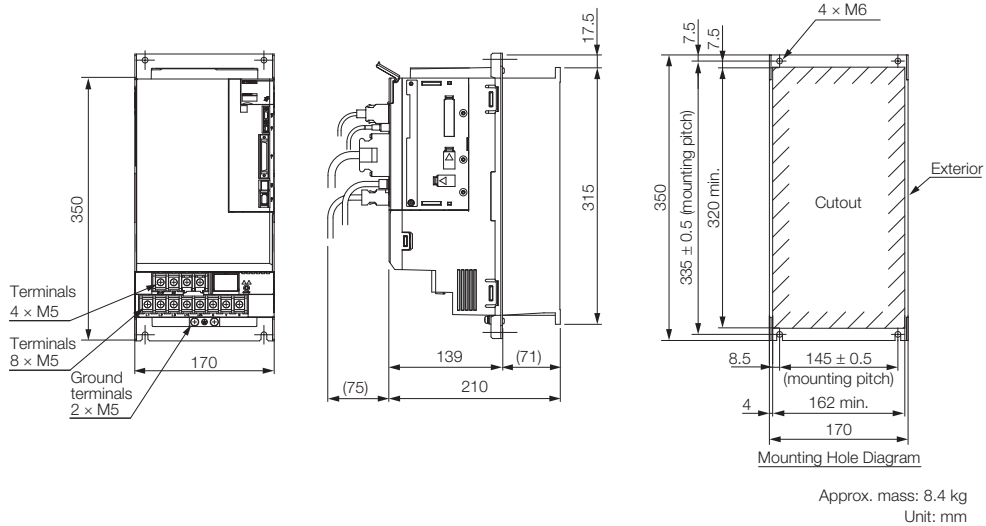

◆ Three-phase, 200 VAC: SGD7S-590A and -780A

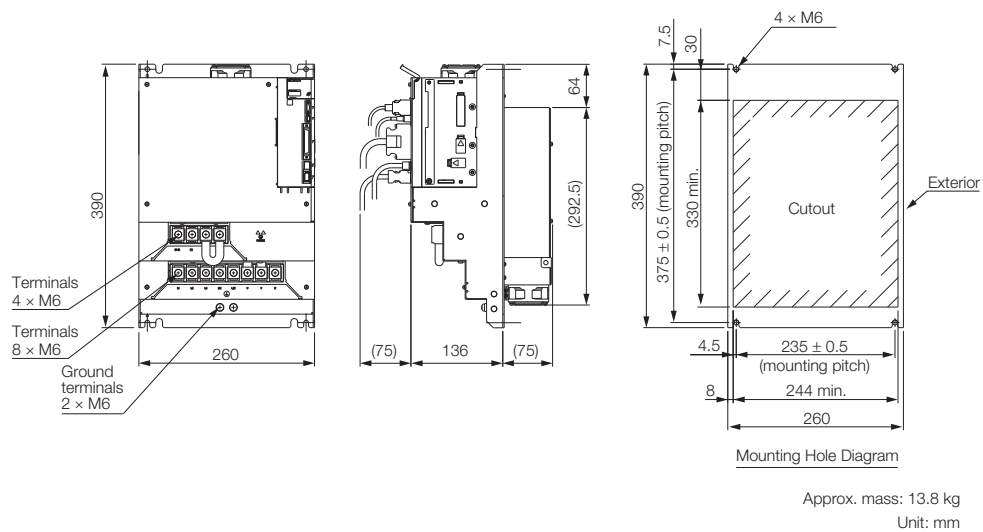

Σ-7W SERVOPACKs: Base-mounted

◆ Three-phase, 200 VAC: SGD7W-1R6A and -2R8A

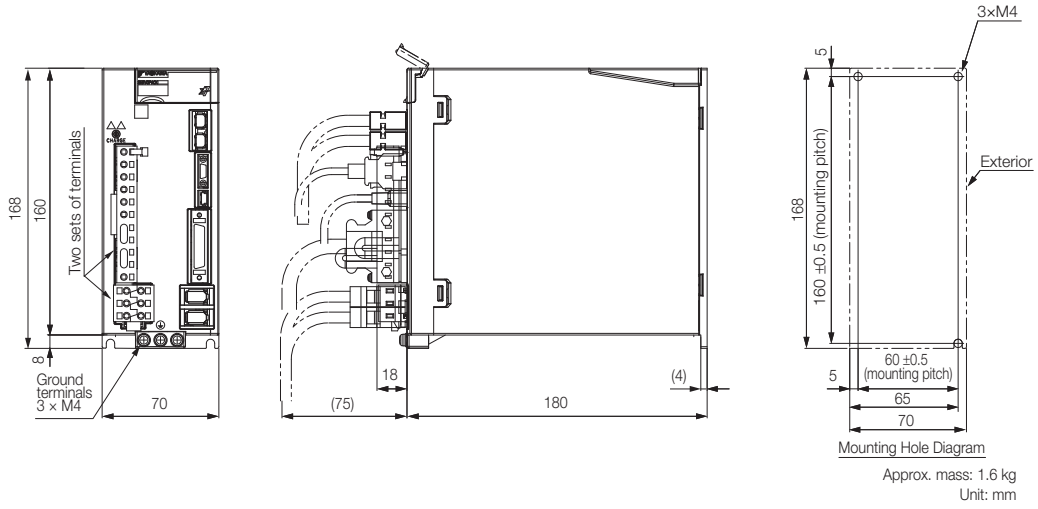

◆ Three-phase, 200 VAC: SGD7W-5R5A and -7R6A

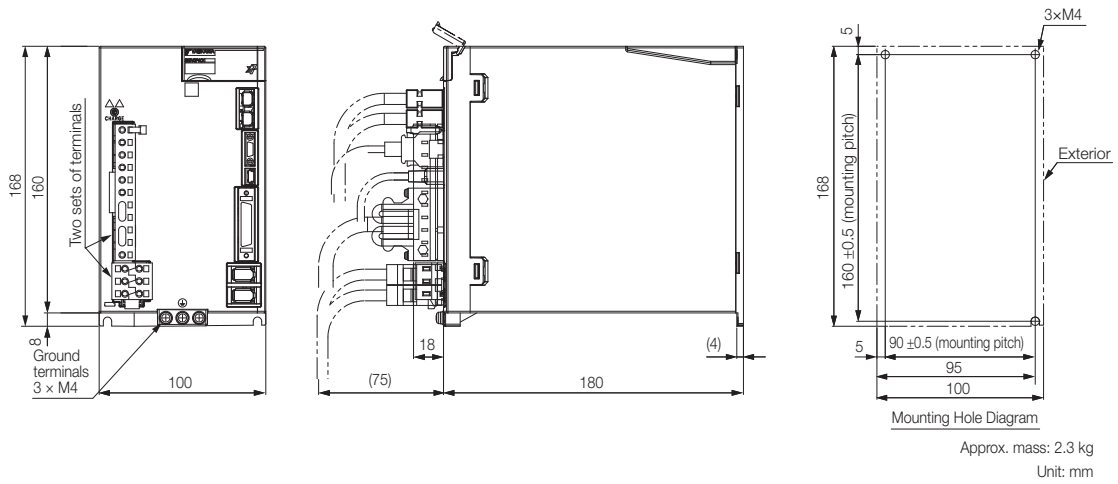

Σ-7W SERVOPACKs: Rack-mounted

◆ Three-phase, 200 VAC: SGD7W-1R6A and -2R8A

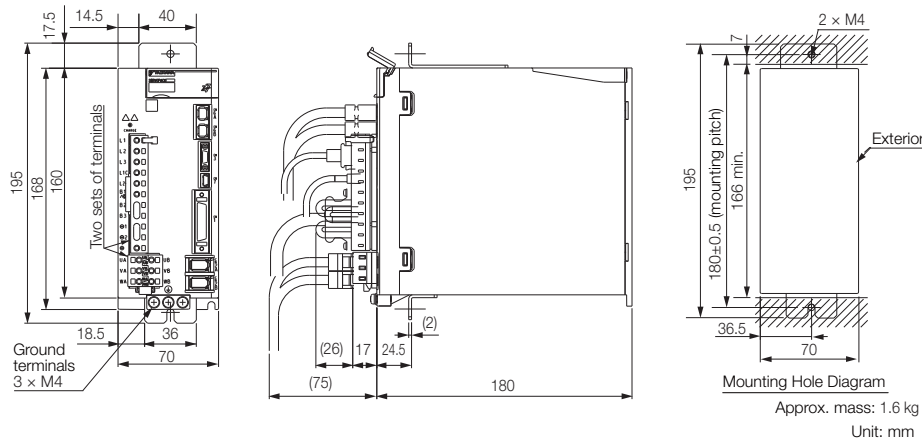

◆ Three-phase, 200 VAC: SGD7W-5R5A and -7R6A

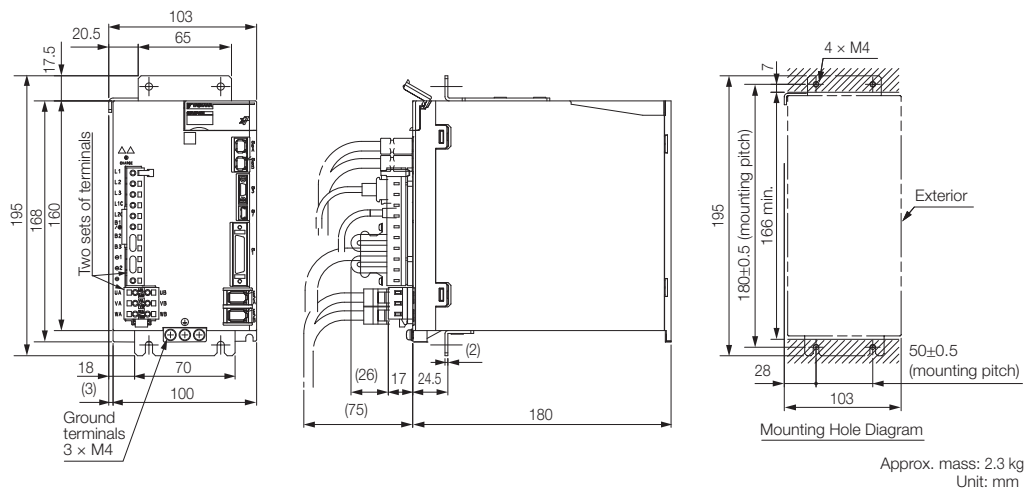

Σ-7C SERVOPACKs: Base-Mounted

◆ Three-phase, 200 VAC: SGD7C-1R6A and -2R8A

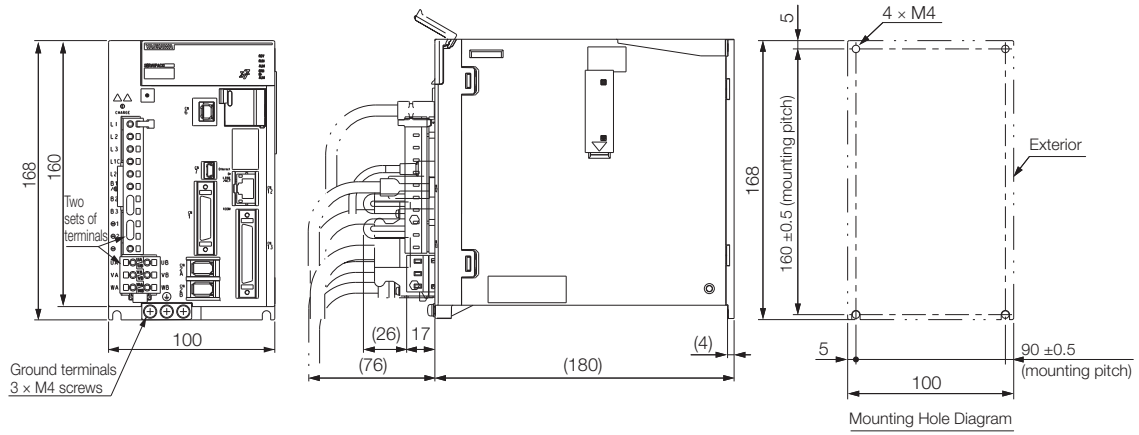

Approx. mass: 2.0 kg
Unit: mm

◆ Three-phase, 200 VAC: SGD7C-5R5A and -7R6A

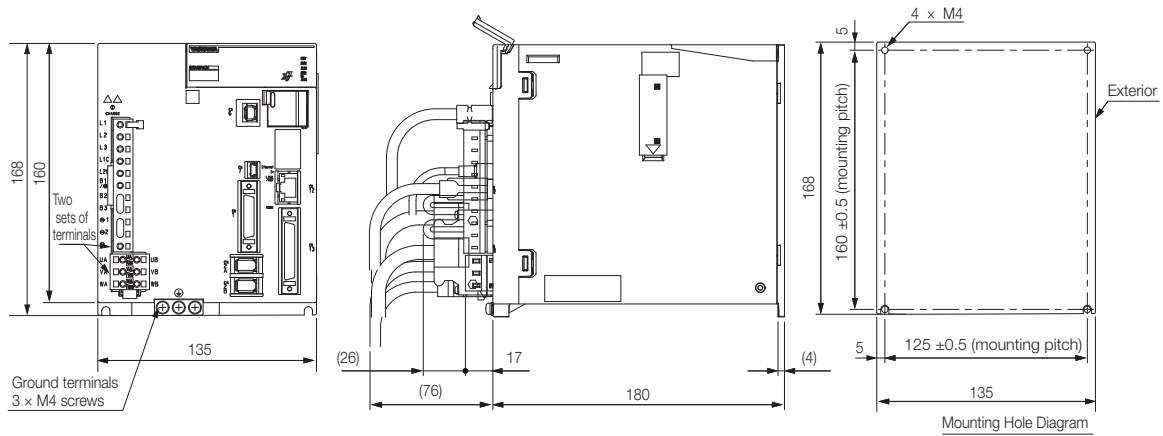

Approx. mass: 2.8 kg
Unit: mm

Σ-7C SERVOPACKs: Rack-Mounted

Hardware Option Code: 001

◆ Three-phase, 200 VAC: SGD7C-1R6A and -2R8A

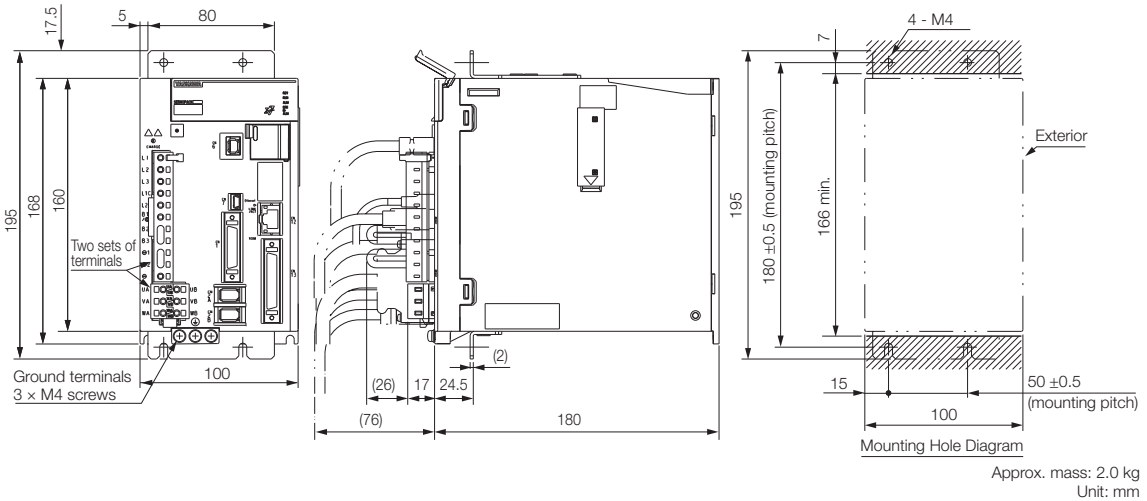

◆ Three-phase, 200 VAC: SGD7C-5R5A and -7R6A

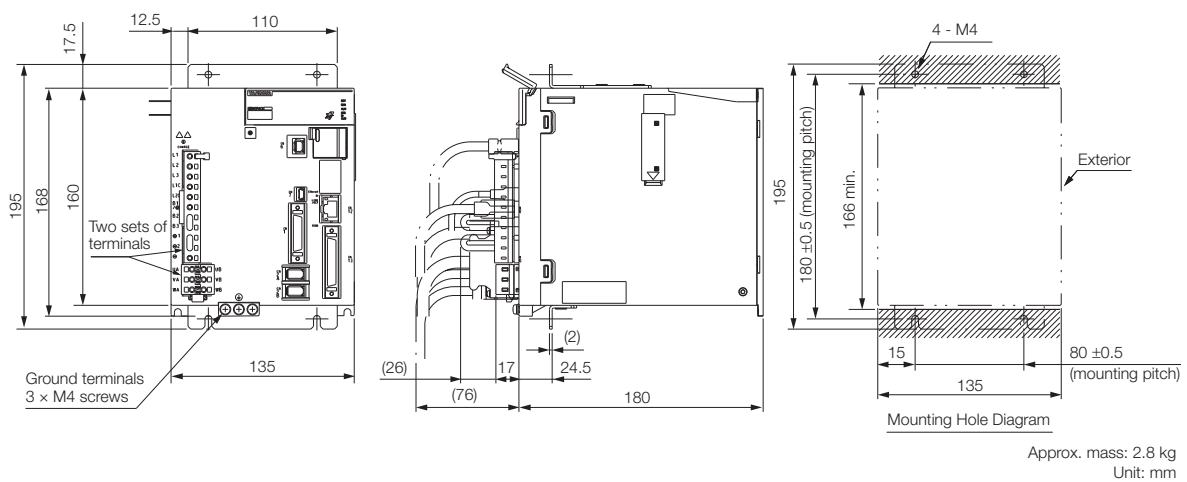

Command Option Module External Dimensions

◆ INDEXER Module

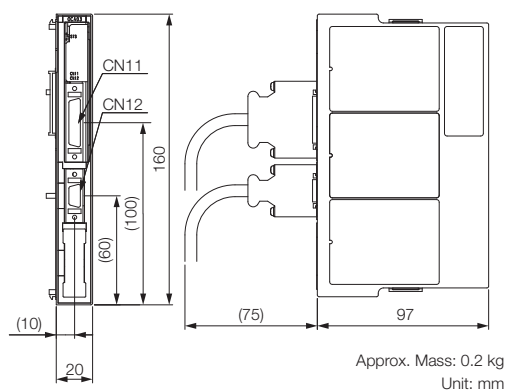

◆ DeviceNet Module

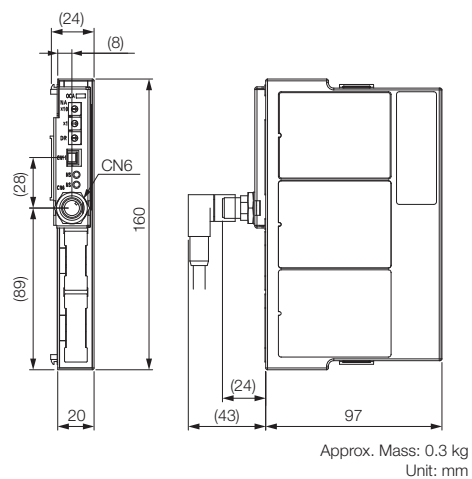

Peripheral Devices

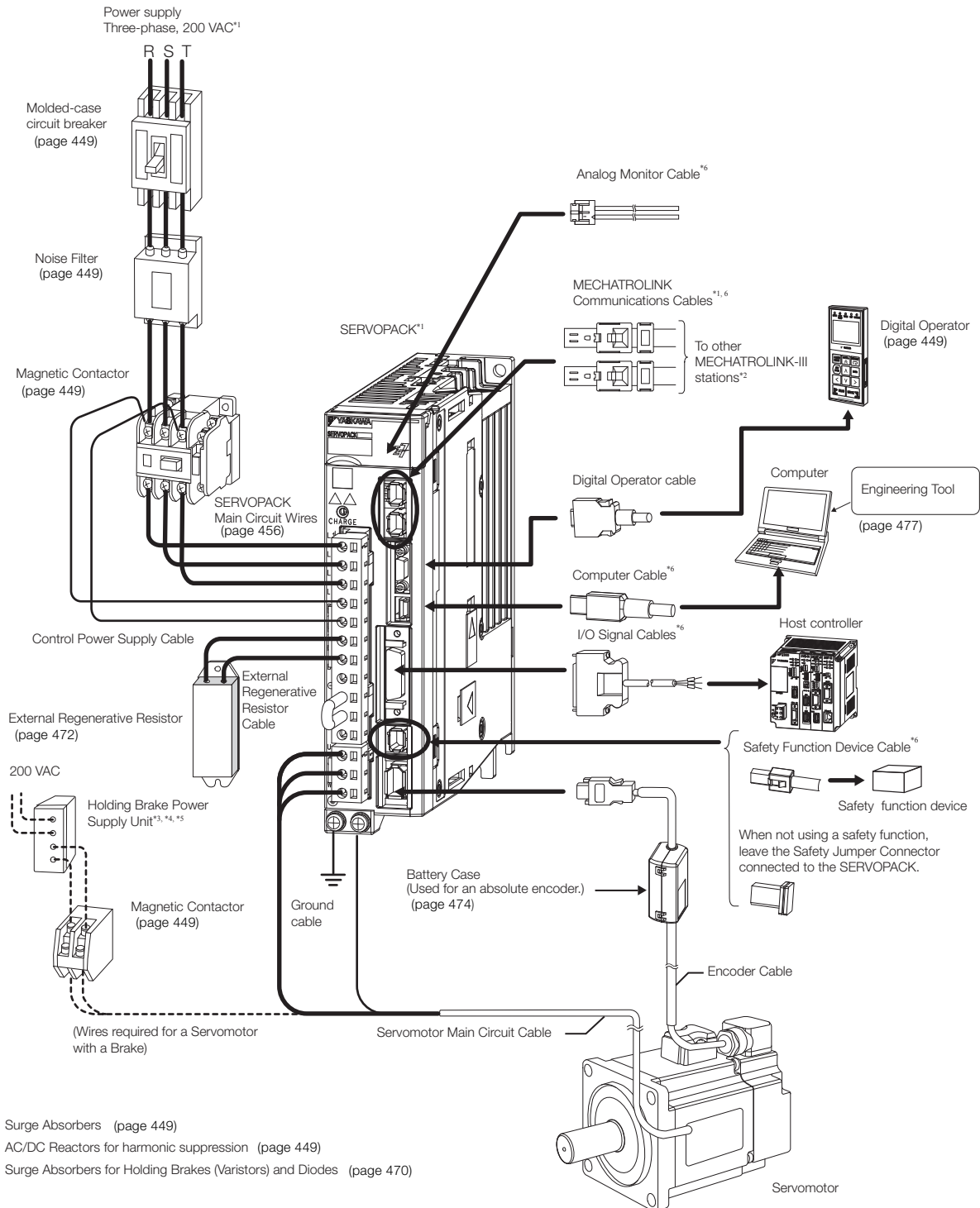

*1. The peripheral devices are described using a MECHATROLINK-III Communications Reference, Three-phase 200 VAC SERVOPACK as an example. The shapes of the connectors may be different for other interfaces.

*2. The connected devices depend on the interface.

For MECHATROLINK-II communications references: Other MECHATROLINK-II stations

For analog voltage/pulse train references: There is no CN6 connector.

*3. A Holding Brake Power Supply Unit is required to use a Servomotor with a Holding Brake. Holding Brake Power Supply Units for 24 VDC are not provided by Yaskawa. Obtain these from other manufacturers. Never connect Holding Brake Power Supply Units with different output voltages to a SERVOPACK. Overcurrent may result in burning in the brake.

*4. If you use a Servomotor with a Holding Brake, select a brake relay according to the power supply voltage and current of the brake. Yaskawa does not recommend any particular brake relays. Select an appropriate brake relay using the selection method of the brake relay manufacturer.

*5. The power supply for the holding brake is not provided by Yaskawa. Select a power supply based on the holding brake specifications. If you use a 24-V brake, install a separate power supply for the 24-VDC power supply from other power supplies, such as the one for the I/O signals of the CN1 connector. If the power supply is shared, the I/O signals may malfunction.

*6. For SERVOPACK cables, refer to the selection table for each type of SERVOPACK.

Peripheral Device Selection Table

◆ Σ-7S SERVOPACKs

Main Circuit Power Supply	Maximum Applicable Motor Capacity [kW]	SERVO-PACK Model: SGD7S-	Noise Filter*1	AC Reactor*2	DC Reactor*2	Magnetic Contactor	Surge Absorber	Digital Operator
Three-phase, 200 VAC	0.05	R70A	HF3010C-SZC	-	X5061	SC-03	LT-C32G801WS	JUSP-OP05A-1-E
	0.1	R90A						
	0.2	1R6A						
	0.4	2R8A						
	0.5	3R8A						
	0.75	5R5A	HF3020C-SZC					
	1.0	7R6A						
	1.5	120A						
	2.0	180A						
	3.0	200A						
	5.0	330A	HF3050C-SZC-47EDD		X5068	SC-N1		
	6.0	470A	X008025					
	7.5	550A	HF3060C-SZC		X008026	SC-N2		
	11	590A	HF3100C-SZC		X008027	SC-N2S		
15	780A	X008028		SC-N3				
Single-phase, 200 VAC	0.05	R70A	HF2010A-UPF	-	X5071	SC-03	LT-C12G801WS	
	0.1	R90A						
	0.2	1R6A						
	0.4	2R8A	X5070					
	0.75	5R5A	HF2020A-UPF-2BB		X5079	SC-4-1		
	1.5	120A□□008	HF2030A-UPF-2BB		X5078	SC-5-1		
Single-phase, 100 VAC	0.05	R70F	HF2010A-UPF	X5053	-	SC-03		
	0.1	R90F		X5054				
	0.2	2R1F	HF2020A-UPF	X5056		SC-4-1		
	0.4	2R8F						

Device	Inquiries
Noise Filters	Yaskawa Controls Co., Ltd.
Surge Absorbers	
AC/DC Reactors for harmonic suppression	
Magnetic Contactors	Fuji Electric FA Components & Systems Co., Ltd.

*1. Some Noise Filters have large leakage currents. The grounding conditions also affect the size of the leakage current. If necessary, select an appropriate leakage detector or leakage breaker taking into account the grounding conditions and the leakage current from the Noise Filter.

*2. The last digit of an RoHS-compliant serial number is R. Consult with Yaskawa Controls Co., Ltd. for RoHS-compliant reactors.

Note: 1. Consult the manufacturer for details on peripheral devices.

2. For Digital Operator Converter cables, refer to the selection table for each type of SERVOPACK.

3. Refer to the following manual for the following information.

- Dimensional drawings, ratings, and specifications of peripheral devices

📖 *Σ-7-Series AC Servo Drive Peripheral Device Selection Manual* (Manual No.: SIEP S800001 32)

◆ Σ -7W SERVOPACKs

Main Circuit Power Supply	Maximum Applicable Motor Capacity per Axis [kW]	SERVO-PACK Model: SGD7W-	Noise Filter* ¹	AC Reactor* ²	DC Reactor* ²	Magnetic Contactor	Surge Absorber	Digital Operator
Three-phase, 200 VAC	0.2	1R6A	HF3010C-SZC	-	X5061	SC-03	LT-C32G801WS	JUSP-OP05A-1-E
	0.4	2R8A	HF3020C-SZC			SC-4-1		
	0.75	5R5A			X5060	SC-5-1		
	1.0	7R6A				X5069		
Single-phase, 200 VAC	0.2	1R6A			HF2010A-UPF	X5079	SC-4-1	
	0.4	2R8A	HF2020A-UPF-2BB		X5078	SC-5-1		
	0.75	5R5A	HF2030A-UPF-2BB					

Device	Inquiries
Noise Filters	Yaskawa Controls Co., Ltd.
Surge Absorbers	
AC/DC Reactors for harmonic suppression	
Magnetic Contactors	Fuji Electric FA Components & Systems Co., Ltd.

*1. Some Noise Filters have large leakage currents. The grounding conditions also affect the size of the leakage current. If necessary, select an appropriate leakage detector or leakage breaker taking into account the grounding conditions and the leakage current from the Noise Filter.

*2. The last digit of an RoHS-compliant serial number is R. Consult with Yaskawa Controls Co., Ltd. for RoHS-compliant reactors.

Note: 1. Consult the manufacturer for details on peripheral devices.

2. Refer to the following section for information on Digital Operator Converter Cables.

 ◆ Selection Table (page 418)

3. Refer to the following manual for the following information.

- Dimensional drawings, ratings, and specifications of peripheral devices

 Σ -7-Series AC Servo Drive Peripheral Device Selection Manual (Manual No.: SIEP S800001 32)

◆ **Σ-7C SERVOPACKs**

Main Circuit Power Supply	Maximum Applicable Motor Capacity per Axis [kW]	SERVO-PACK Model: SGM7C-	Noise Filter* ¹	AC Reactor* ²	DC Reactor* ²	Magnetic Contactor	Surge Absorber
Three-phase, 200 VAC	0.2	1R6A	HF3010C-SZC	-	X5061	SC-03	LT-C32G801WS
	0.4	2R8A	HF3020C-SZC			SC-4-1	
	0.75	5R5A			X5060	SC-5-1	
	1.0	7R6A					
Single-phase, 200 VAC	0.2	1R6A	HF2010A-UPF	-	X5069	SC-03	LT-C12G801WS
	0.4	2R8A	HF2020A-UPF-2BB		X5079	SC-4-1	
	0.75	5R5A	HF2030A-UPF-2BB		X5078	SC-5-1	

Device	Inquiries
Noise Filters	Yaskawa Controls Co., Ltd.
Surge Absorbers	
AC/DC Reactors for harmonic suppression	
Magnetic Contactors	Fuji Electric FA Components & Systems Co., Ltd.

*1. Some Noise Filters have large leakage currents. The grounding conditions also affect the size of the leakage current. If necessary, select an appropriate leakage detector or leakage breaker taking into account the grounding conditions and the leakage current from the Noise Filter.

*2. The last digit of an RoHS-compliant serial number is R. Consult with Yaskawa Controls Co., Ltd. for RoHS-compliant reactors.

Note: 1. Consult the manufacturer for details on peripheral devices.

2. Refer to the following manual for the following information.

- Dimensional drawings, ratings, and specifications of peripheral devices

📖 *Σ-7-Series AC Servo Drive Peripheral Device Selection Manual (Manual No.: SIEP S800001 32)*

Molded-case Circuit Breakers and Fuses

Using an AC Power Supply

Use a molded-case circuit breaker and fuse to protect the power supply line. They protect the power line by shutting OFF the circuit when overcurrent is detected. Select these devices based on the information in the following tables.

Note: The following tables also provide the net values of the current capacity and inrush current. Select a fuse and a molded-case circuit breaker that meet the following conditions.

- Main circuit and control circuit: No breaking at three times the current value given in the table for 5 s.
- Inrush current: No breaking at the current value given in the table for 20 ms.

◆ Σ-7S SERVOPACKs

Main Circuit Power Supply	Maximum Applicable Motor Capacity [kW]	SERVOPACK Model: SGD7S-	Power Supply Capacity per SERVOPACK [kVA]*	Current Capacity		Inrush Current		Rated Voltage	
				Main Circuit [Arms]*	Control Power Supply [Arms]	Main Circuit [A0-p]	Control Power Supply [A0-p]	Fuse [M]	MCCB [M]
Three-phase, 200 VAC	0.05	R70A	0.2	0.4	0.2	34	34	250	240
	0.1	R90A	0.3	0.8					
	0.2	1R6A	0.5	1.3					
	0.4	2R8A	1.0	2.5					
	0.5	3R8A	1.3	3.0					
	0.75	5R5A	1.6	4.1					
	1.0	7R6A	2.3	5.7					
	1.5	120A	3.2	7.3	0.25				
	2.0	180A	4.0	10					
	3.0	200A	5.9	15					
	5.0	330A	7.5	25	0.3	68			
	6.0	470A	10.7	29					
	7.5	550A	14.6	37	0.4	114			
	11	590A	21.7	54					
15	780A	29.6	73						
Single-phase, 200 VAC	0.05	R70A	0.2	0.8	0.2	34			
	0.1	R90A	0.3	1.6					
	0.2	1R6A	0.6	2.4					
	0.4	2R8A	1.2	5.0					
	0.75	5R5A	1.9	8.7					
	1.5	120A□□□008	4.0	16	0.25				
Single-phase, 100 VAC	0.05	R70F	0.2	1.5	0.38				
	0.1	R90F	0.3	2.5					
	0.2	2R1F	0.6	5					
	0.4	2R8F	1.4	10					

* This is the net value at the rated load.

◆ Σ-7W SERVOPACKs

Main Circuit Power Supply	Maximum Applicable Motor Capacity per Axis [kW]	SERVOPACK Model: SGD7W-	Power Supply Capacity per SERVOPACK [kVA]*1	Current Capacity		Inrush Current		Rated Voltage	
				Main Circuit [Arms]*1	Control Power Supply [Arms]	Main Circuit [A0-p]	Control Power Supply [A0-p]	Fuse [V]	MCCB [V]
Three-phase, 200 VAC	0.2	1R6A	1.0	2.5	0.25	34	34	250	240
	0.4	2R8A	1.9	4.7					
	0.75	5R5A	3.2	7.8					
	1.0	7R6A	4.5	11					
Single-phase, 200 VAC	0.2	1R6A	1.3	5.5	0.25	34	34	250	240
	0.4	2R8A	2.4	11					
	0.75	5R5A*2	2.7	12					

*1. This is the net value at the rated load.

*2. If you use the SGD7W-5R5A with a single-phase 200-VAC power supply input, derate the load ratio to 65%. An example is given below.

If the load ratio of the first axis is 90%, use a load ratio of 40% for the second axis so that average load ratio for both axes is 65% ((90% + 40%)/2 = 65%).

◆ Σ-7C SERVOPACKs

Main Circuit Power Supply	Maximum Applicable Motor Capacity per Axis [kW]	SERVOPACK Model: SGM7C-	Power Supply Capacity per SERVOPACK [kVA]*1	Current Capacity		Inrush Current		Rated Voltage	
				Main Circuit [Arms]*1	Control Power Supply [Arms]	Main Circuit [A0-p]	Control Power Supply [A0-p]	Fuse [V]	MCCB [V]
Three-phase, 200 VAC	0.2	1R6A	1.0	2.5	0.25	34	34	250	240
	0.4	2R8A	1.9	4.7					
	0.75	5R5A	3.2	7.8					
	1.0	7R6A	4.5	11					
Single-phase, 200 VAC	0.2	1R6A	1.3	5.5	0.25	34	34	250	240
	0.4	2R8A	2.4	11					
	0.75	5R5A*2	2.7	12					

*1. This is the net value at the rated load.

*2. If you use the SGM7C-5R5A with a single-phase 200-VAC power supply input, derate the load ratio to 65%. An example is given below.

If the load ratio of the first axis is 90%, use a load ratio of 40% for the second axis so that average load ratio for both axes is 65% ((90% + 40%)/2 = 65%).

Using a DC Power Supply

This section gives the power supply specifications for using a DC power supply input. Use the Fuses given in the following tables to protect the power supply line and SERVOPACK. They protect the power line by shutting OFF the circuit when overcurrent is detected.

Note: The following tables provide the net values of the current capacity and inrush current.

◆ Σ-7S SERVOPACKs

Main Circuit Power Supply	SERVOPACK Model: SGD7S-	Power Supply Capacity per SERVOPACK [kVA] ^{*1}	Current Capacity		Inrush Current		External Fuse					
			Main Circuit [Arms] ^{*1}	Control Power Supply [Arms]	Main Circuit [A0-p]	Control Power Supply [A0-p]	Order Number ^{*2}	Current Rating [A]	Voltage Rating [Vdc]			
270 VDC	R70A	0.2	0.5	0.2	34	34	3,5URGJ17/16UL	16	400			
	R90A	0.3	1.0									
	1R6A	0.5	1.5									
	2R8A	1.0	3.0									
	3R8A	1.3	3.8	0.2			3,5URGJ17/40UL	40				
	5R5A	1.6	4.9									
	7R6A	2.3	6.9									
	120A	3.2	11	0.2			34	34		3,5URGJ17/63UL	63	
	120A□□□□008			0.25								
	180A											14
	200A											20
	330A	7.5	34	0.3			68 ^{*3} (5 Ω external)	3,5URGJ17/100UL		100		
	470A	10.7	36									
	550A	14.6	48									
590A	21.7	68	0.4	114 ^{*3} (3 Ω external)	3,5URGJ23/200UL	200						
780A	29.6	92										

*1. This is the net value at the rated load.

*2. These Fuses are manufactured by MERSEN Japan.

*3. If you use a DC power supply input with any of the following SERVOPACKs, externally connect an inrush current limiting circuit and use the power ON and OFF sequences recommended by Yaskawa: SGD7S-330A, -470A, -550A, -590A, or -780A.

There is a risk of equipment damage.

For information on the power ON and OFF sequences, refer to the product manual for the type of references used by your SERVOPACK.

◆ Σ-7W SERVOPACKs

Main Circuit Power Supply	SERVOPACK Model: SGD7W-	Power Supply Capacity per SERVOPACK [kVA] ^{*1}	Current Capacity		Inrush Current		External Fuse		
			Main Circuit [Arms] ^{*1}	Control Power Supply [Arms]	Main Circuit [A0-p]	Control Power Supply [A0-p]	Order Number ^{*2}	Current Rating [A]	Voltage Rating [Vdc]
270 VDC	1R6A	1	3.0	0.25	34	34	3,5URGJ17/40UL	40	400
	2R8A	1.9	5.8						
	5R5A	3.2	9.7				3,5URGJ17/63UL	63	
	7R6A	4.5	14						

*1. This is the net value at the rated load.

*2. These Fuses are manufactured by MERSEN Japan.

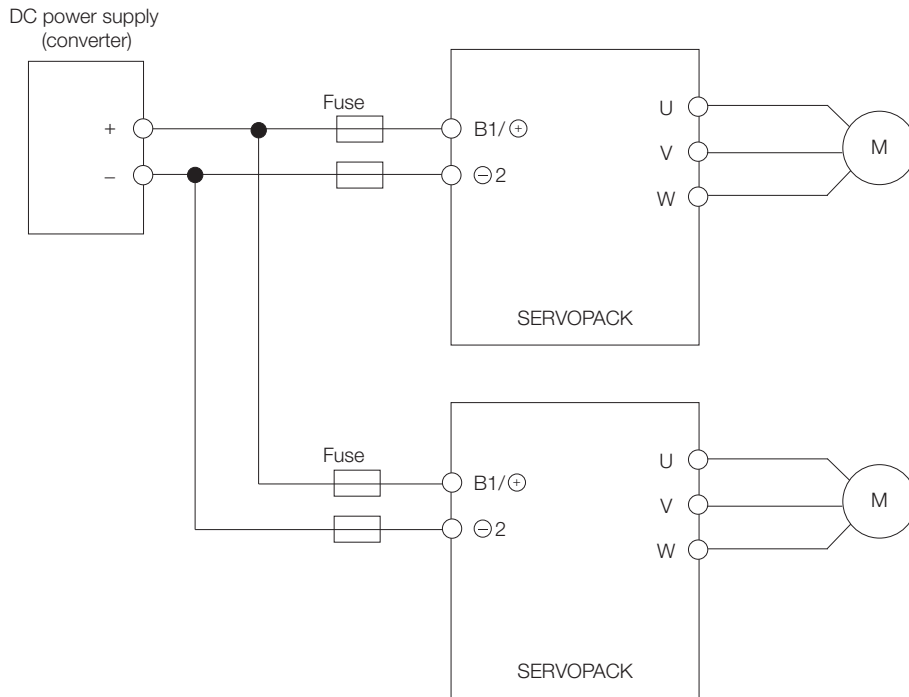

Note: If you connect more than one SERVOPACK to the same DC power supply, connect Fuses for each SERVO-PACK.

SERVOPACK Main Circuit Wires

This section describes the main circuit wires for SERVOPACKS.



- These specifications are based on IEC/EN 61800-5-1, UL 61800-5-1, and CSA C22.2 No.274.
1. To comply with UL standards, use UL-compliant wires.
 2. Use copper wires with a rated temperature of 75° or higher.
 3. Use copper wires with a rated withstand voltage of 300 V or higher.

Note: To use 600-V heat-resistant polyvinyl chloride-insulated wire (HIV), use the following table as reference for the applicable wires.

- The specified wire sizes are for three bundled leads when the rated current is applied with a surrounding air temperature of 40°C.
- Select the wires according to the surrounding air temperature.

Three-phase, 200-VAC Wires for Σ -7S SERVOPACKS

SERVOPACK Model: SGD7S-	Terminals		Wire Size	Screw Size	Tightening Torque [N·m]
R70A	Main Circuit Power Supply Cable	L1, L2, L3	AWG16 (1.25 mm ²)	-	-
	Servomotor Main Circuit Cable*	U, V, W			
	Control Power Supply Cable	L1C, L2C			
	External Regenerative Resistor Cable	B1/⊕, B2			
	Ground cable	⊕	AWG14 (2.0 mm ²) min.	M4	1.2 to 1.4
R90A	Main Circuit Power Supply Cable	L1, L2, L3	AWG16 (1.25 mm ²)	-	-
	Servomotor Main Circuit Cable*	U, V, W			
	Control Power Supply Cable	L1C, L2C			
	External Regenerative Resistor Cable	B1/⊕, B2			
	Ground cable	⊕	AWG14 (2.0 mm ²) min.	M4	1.2 to 1.4
1R6A	Main Circuit Power Supply Cable	L1, L2, L3	AWG16 (1.25 mm ²)	-	-
	Servomotor Main Circuit Cable*	U, V, W			
	Control Power Supply Cable	L1C, L2C			
	External Regenerative Resistor Cable	B1/⊕, B2			
	Ground cable	⊕	AWG14 (2.0 mm ²) min.	M4	1.2 to 1.4
2R8A	Main Circuit Power Supply Cable	L1, L2, L3	AWG16 (1.25 mm ²)	-	-
	Servomotor Main Circuit Cable*	U, V, W			
	Control Power Supply Cable	L1C, L2C			
	External Regenerative Resistor Cable	B1/⊕, B2			
	Ground cable	⊕	AWG14 (2.0 mm ²) min.	M4	1.2 to 1.4
3R8A	Main Circuit Power Supply Cable	L1, L2, L3	AWG16 (1.25 mm ²)	-	-
	Servomotor Main Circuit Cable*	U, V, W			
	Control Power Supply Cable	L1C, L2C			
	External Regenerative Resistor Cable	B1/⊕, B2			
	Ground cable	⊕	AWG14 (2.0 mm ²) min.	M4	1.2 to 1.4
5R5A	Main Circuit Power Supply Cable	L1, L2, L3	AWG16 (1.25 mm ²)	-	-
	Servomotor Main Circuit Cable*	U, V, W			
	Control Power Supply Cable	L1C, L2C			
	External Regenerative Resistor Cable	B1/⊕, B2			
	Ground cable	⊕	AWG14 (2.0 mm ²) min.	M4	1.2 to 1.4

Continued on next page.

Continued from previous page.

SERVOPACK Model: SGD7S-	Terminals		Wire Size	Screw Size	Tightening Torque [N·m]
7R6A	Main Circuit Power Supply Cable	L1, L2, L3	AWG16 (1.25 mm ²)	-	-
	Servomotor Main Circuit Cable*	U, V, W			
	Control Power Supply Cable	L1C, L2C			
	External Regenerative Resistor Cable	B1/⊕, B2			
	Ground cable	⊕	AWG14 (2.0 mm ²) min.	M4	1.2 to 1.4
120A	Main Circuit Power Supply Cable	L1, L2, L3	AWG14 (2.0 mm ²)	-	-
	Servomotor Main Circuit Cable*	U, V, W			
	Control Power Supply Cable	L1C, L2C			
	External Regenerative Resistor Cable	B1/⊕, B2			
	Ground cable	⊕	AWG14 (2.0 mm ²) min.	M4	1.2 to 1.4
180A	Main Circuit Power Supply Cable	L1, L2, L3	AWG14 (2.0 mm ²)	M4	1.0 to 1.2
	Servomotor Main Circuit Cable*	U, V, W	AWG10 (5.5 mm ²)		
	Control Power Supply Cable	L1C, L2C	AWG16 (1.25 mm ²)		
	External Regenerative Resistor Cable	B1/⊕, B2			
	Ground cable	⊕	AWG14 (2.0 mm ²) min.	M4	1.2 to 1.4
200A	Main Circuit Power Supply Cable	L1, L2, L3	AWG12 (3.5 mm ²)	M4	1.0 to 1.2
	Servomotor Main Circuit Cable*	U, V, W	AWG10 (5.5 mm ²)		
	Control Power Supply Cable	L1C, L2C	AWG16 (1.25 mm ²)		
	External Regenerative Resistor Cable	B1/⊕, B2			
	Ground cable	⊕	AWG14 (2.0 mm ²) min.	M4	1.2 to 1.4
330A	Main Circuit Power Supply Cable	L1, L2, L3	AWG8 (8.0 mm ²)	M4	1.0 to 1.2
	Servomotor Main Circuit Cable*	U, V, W			
	Control Power Supply Cable	L1C, L2C	AWG16 (1.25 mm ²)		
	External Regenerative Resistor Cable	B1/⊕, B2	AWG14 (2.0 mm ²)		
	Ground cable	⊕	AWG14 (2.0 mm ²) min.	M4	1.2 to 1.4
470A	Main Circuit Power Supply Cable	L1, L2, L3	AWG8 (8.0 mm ²)	M5	2.2 to 2.4
	Servomotor Main Circuit Cable*	U, V, W	AWG6 (14 mm ²)		
	Control Power Supply Cable	L1C, L2C	AWG16 (1.25 mm ²)		
	External Regenerative Resistor Cable	B1/⊕, B2	AWG14 (2.0 mm ²)		
	Ground cable	⊕	AWG14 (2.0 mm ²) min.		
550A	Main Circuit Power Supply Cable	L1, L2, L3	AWG8 (8.0 mm ²)	M5	2.2 to 2.4
	Servomotor Main Circuit Cable*	U, V, W	AWG4 (22 mm ²)		
	Control Power Supply Cable	L1C, L2C	AWG16 (1.25 mm ²)		
	External Regenerative Resistor Cable	B1/⊕, B2	AWG10 (5.5 mm ²)		
	Ground cable	⊕	AWG14 (2.0 mm ²) min.		
590A	Main Circuit Power Supply Cable	L1, L2, L3	AWG4 (22 mm ²)	M6	2.7 to 3.0
	Servomotor Main Circuit Cable*	U, V, W			
	Control Power Supply Cable	L1C, L2C	AWG16 (1.25 mm ²)		
	External Regenerative Resistor Cable	B1/⊕, B2	AWG10 (5.5 mm ²)		
	Ground cable	⊕	AWG14 (2.0 mm ²) min.		
780A	Main Circuit Power Supply Cable	L1, L2, L3	AWG3 (30 mm ²)	M6	2.7 to 3.0
	Servomotor Main Circuit Cable*	U, V, W			
	Control Power Supply Cable	L1C, L2C	AWG16 (1.25 mm ²)		
	External Regenerative Resistor Cable	B1/⊕, B2	AWG8 (8.0 mm ²)		
	Ground cable	⊕	AWG14 (2.0 mm ²) min.		

* If you do not use the recommended Servomotor Main Circuit Cable, use this table to select wires.

Single-phase, 200-VAC Wires for Σ -7S SERVOPACKs

SERVOPACK Model: SGD7S-	Terminals		Wire Size	Screw Size	Tightening Torque [N·m]
R70A	Main Circuit Power Supply Cable	L1, L2	AWG16 (1.25 mm ²)	-	-
	Servomotor Main Circuit Cable*	U, V, W			
	Control Power Supply Cable	L1C, L2C			
	External Regenerative Resistor Cable	B1/⊕, B2			
	Ground cable	⊕	AWG14 (2.0 mm ²) min.	M4	1.2 to 1.4
R90A	Main Circuit Power Supply Cable	L1, L2	AWG16 (1.25 mm ²)	-	-
	Servomotor Main Circuit Cable*	U, V, W			
	Control Power Supply Cable	L1C, L2C			
	External Regenerative Resistor Cable	B1/⊕, B2			
	Ground cable	⊕	AWG14 (2.0 mm ²) min.	M4	1.2 to 1.4
1R6A	Main Circuit Power Supply Cable	L1, L2, L3	AWG16 (1.25 mm ²)	-	-
	Servomotor Main Circuit Cable*	U, V, W			
	Control Power Supply Cable	L1C, L2C			
	External Regenerative Resistor Cable	B1/⊕, B2			
	Ground cable	⊕	AWG14 (2.0 mm ²) min.	M4	1.2 to 1.4
2R8A	Main Circuit Power Supply Cable	L1, L2, L3	AWG16 (1.25 mm ²)	-	-
	Servomotor Main Circuit Cable*	U, V, W			
	Control Power Supply Cable	L1C, L2C			
	External Regenerative Resistor Cable	B1/⊕, B2			
	Ground cable	⊕	AWG14 (2.0 mm ²) min.	M4	1.2 to 1.4
5R5A	Main Circuit Power Supply Cable	L1, L2, L3	AWG14 (2.0 mm ²)	-	-
	Servomotor Main Circuit Cable*	U, V, W	AWG16 (1.25 mm ²)		
	Control Power Supply Cable	L1C, L2C			
	External Regenerative Resistor Cable	B1/⊕, B2			
	Ground cable	⊕	AWG14 (2.0 mm ²) min.	M4	1.2 to 1.4
120A□□□008	Main Circuit Power Supply Cables	L1, L2	AWG14 (2.0 mm ²)	M4	1.0 to 1.2
	Servomotor Main Circuit Cables*	U, V, W	AWG16 (1.25 mm ²)		
	Control Power Supply Cables	L1C, L2C			
	External Regenerative Resistor Cables	B1/⊕, B2	AWG14 (2.0 mm ²) min.		1.2 to 1.4
	Ground cable	⊕			

* If you do not use the recommended Servomotor Main Circuit Cable, use this table to select wires.

Single-phase, 100-VAC Wires for Σ -7S SERVOPACKs

SERVOPACK Model: SGD7S-	Terminals		Wire Size	Screw Size	Tightening Torque [N·m]
R70F	Main Circuit Power Supply Cable	L1, L2	AWG16 (1.25 mm ²)	-	-
	Servomotor Main Circuit Cable*	U, V, W			
	Control Power Supply Cable	L1C, L2C			
	External Regenerative Resistor Cable	B1/⊕, B2			
	Ground cable	⊕	AWG14 (2.0 mm ²) min.	M4	1.2 to 1.4
R90F	Main Circuit Power Supply Cable	L1, L2	AWG16 (1.25 mm ²)	-	-
	Servomotor Main Circuit Cable*	U, V, W			
	Control Power Supply Cable	L1C, L2C			
	External Regenerative Resistor Cable	B1/⊕, B2			
	Ground cable	⊕	AWG14 (2.0 mm ²) min.	M4	1.2 to 1.4
2R1F	Main Circuit Power Supply Cable	L1, L2	AWG16 (1.25 mm ²)	-	-
	Servomotor Main Circuit Cable*	U, V, W			
	Control Power Supply Cable	L1C, L2C			
	External Regenerative Resistor Cable	B1/⊕, B2			
	Ground cable	⊕	AWG14 (2.0 mm ²) min.	M4	1.2 to 1.4
2R8F	Main Circuit Power Supply Cable	L1, L2	AWG14 (2.0 mm ²)	-	-
	Servomotor Main Circuit Cable*	U, V, W	AWG16 (1.25 mm ²)		
	Control Power Supply Cable	L1C, L2C			
	External Regenerative Resistor Cable	B1/⊕, B2			
	Ground cable	⊕	AWG14 (2.0 mm ²) min.	M4	1.2 to 1.4

* If you do not use the recommended Servomotor Main Circuit Cable, use this table to select wires.

DC Power Supply Wires for Σ -7S SERVOPACKs

SERVOPACK Model: SGD7S-	Terminals*1		Wire Size	Screw Size	Tightening Torque [N·m]
R70A	Servomotor Main Circuit Cables	U, V, W*2	AWG16 (1.25 mm ²)	–	–
	Control Power Supply Cables	L1C, L2C	AWG16 (1.25 mm ²)	–	–
	Main Circuit Power Supply Cables	B1/⊕, ⊖2	AWG16 (1.25 mm ²)	–	–
	Ground Cable	⊕	AWG14 (2.0 mm ²) min.	M4	1.2 to 1.4
R90A	Servomotor Main Circuit Cables	U, V, W*2	AWG16 (1.25 mm ²)	–	–
	Control Power Supply Cables	L1C, L2C	AWG16 (1.25 mm ²)	–	–
	Main Circuit Power Supply Cables	B1/⊕, ⊖2	AWG16 (1.25 mm ²)	–	–
	Ground Cable	⊕	AWG14 (2.0 mm ²) min.	M4	1.2 to 1.4
1R6A	Servomotor Main Circuit Cables	U, V, W*2	AWG16 (1.25 mm ²)	–	–
	Control Power Supply Cables	L1C, L2C	AWG16 (1.25 mm ²)	–	–
	Main Circuit Power Supply Cables	B1/⊕, ⊖2	AWG16 (1.25 mm ²)	–	–
	Ground Cable	⊕	AWG14 (2.0 mm ²) min.	M4	1.2 to 1.4
2R8A	Servomotor Main Circuit Cables	U, V, W*2	AWG16 (1.25 mm ²)	–	–
	Control Power Supply Cables	L1C, L2C	AWG16 (1.25 mm ²)	–	–
	Main Circuit Power Supply Cables	B1/⊕, ⊖2	AWG16 (1.25 mm ²)	–	–
	Ground Cable	⊕	AWG14 (2.0 mm ²) min.	M4	1.2 to 1.4
3R8A	Servomotor Main Circuit Cables	U, V, W*2	AWG16 (1.25 mm ²)	–	–
	Control Power Supply Cables	L1C, L2C	AWG16 (1.25 mm ²)	–	–
	Main Circuit Power Supply Cables	B1/⊕, ⊖2	AWG16 (1.25 mm ²)	–	–
	Ground Cable	⊕	AWG14 (2.0 mm ²) min.	M4	1.2 to 1.4
5R5A	Servomotor Main Circuit Cables	U, V, W*2	AWG16 (1.25 mm ²)	–	–
	Control Power Supply Cables	L1C, L2C	AWG16 (1.25 mm ²)	–	–
	Main Circuit Power Supply Cables	B1/⊕, ⊖2	AWG16 (1.25 mm ²)	–	–
	Ground Cable	⊕	AWG14 (2.0 mm ²) min.	M4	1.2 to 1.4
7R6A	Servomotor Main Circuit Cables	U, V, W*2	AWG16 (1.25 mm ²)	–	–
	Control Power Supply Cables	L1C, L2C	AWG16 (1.25 mm ²)	–	–
	Main Circuit Power Supply Cables	B1/⊕, ⊖2	AWG16 (1.25 mm ²)	–	–
	Ground Cable	⊕	AWG14 (2.0 mm ²) min.	M4	1.2 to 1.4
120A (three-phase, 200-VAC input)	Servomotor Main Circuit Cables	U, V, W*2	AWG14 (2.0 mm ²)	–	–
	Control Power Supply Cables	L1C, L2C	AWG16 (1.25 mm ²)	–	–
	Main Circuit Power Supply Cables	B1/⊕, ⊖2	AWG14 (2.0 mm ²)	–	–
	Ground Cable	⊕	AWG14 (2.0 mm ²) min.	M4	1.2 to 1.4
120A□□□008 (single-phase, 200-VAC input)	Servomotor Main Circuit Cables	U, V, W*2	AWG14 (2.0 mm ²)	M4	1.0 to 1.2
	Control Power Supply Cables	L1C, L2C	AWG16 (1.25 mm ²)	M4	1.0 to 1.2
	Main Circuit Power Supply Cables	B1/⊕, ⊖2	AWG14 (2.0 mm ²)	M4	1.0 to 1.2
	Ground Cable	⊕	AWG14 (2.0 mm ²) min.	M4	1.2 to 1.4
180A	Servomotor Main Circuit Cables	U, V, W*2	AWG10 (5.5 mm ²)	M4	1.0 to 1.2
	Control Power Supply Cables	L1C, L2C	AWG16 (1.25 mm ²)	M4	1.0 to 1.2
	Main Circuit Power Supply Cables	B1/⊕, ⊖2	AWG10 (5.5 mm ²)	M4	1.0 to 1.2
	Ground Cable	⊕	AWG14 (2.0 mm ²) min.	M4	1.2 to 1.4

Continued on next page.

Continued from previous page.

SERVOPACK Model: SGD7S-	Terminals* ¹		Wire Size	Screw Size	Tightening Torque [N·m]
200A	Servomotor Main Circuit Cables	U, V, W* ²	AWG10 (5.5 mm ²)	M4	1.0 to 1.2
	Control Power Supply Cables	L1C, L2C	AWG16 (1.25 mm ²)	M4	1.0 to 1.2
	Main Circuit Power Supply Cables	B1/⊕, ⊖2	AWG10 (5.5 mm ²)	M4	1.0 to 1.2
	Ground Cable	⊕	AWG14 (2.0 mm ²) min.	M4	1.2 to 1.4
330A	Servomotor Main Circuit Cables	U, V, W	AWG8 (8.0 mm ²)	M4	1.0 to 1.2
	Control Power Supply Cables	L1C, L2C	AWG16 (1.25 mm ²)	M4	1.0 to 1.2
	Main Circuit Power Supply Cables	B1/⊕, ⊖2	AWG8 (8.0 mm ²)	M4	1.0 to 1.2
	Ground Cable	⊕	AWG14 (2.0 mm ²) min.	M4	1.2 to 1.4
470A	Servomotor Main Circuit Cables	U, V, W	AWG6 (14 mm ²)	M5	2.2 to 2.4
	Control Power Supply Cables	L1C, L2C	AWG16 (1.25 mm ²)	M5	2.2 to 2.4
	Main Circuit Power Supply Cables	B1/⊕, ⊖2	AWG8 (8.0 mm ²)	M5	2.2 to 2.4
	Ground Cable	⊕	AWG14 (2.0 mm ²) min.	M5	2.2 to 2.4
550A	Servomotor Main Circuit Cables	U, V, W	AWG4 (22 mm ²)	M5	2.2 to 2.4
	Control Power Supply Cables	L1C, L2C	AWG16 (1.25 mm ²)	M5	2.2 to 2.4
	Main Circuit Power Supply Cables	B1/⊕, ⊖2	AWG6 (14 mm ²)	M5	2.2 to 2.4
	Ground Cable	⊕	AWG14 (2.0 mm ²) min.	M5	2.2 to 2.4
590A	Servomotor Main Circuit Cables	U, V, W	AWG4 (22 mm ²)	M6	2.7 to 3.0
	Control Power Supply Cables	L1C, L2C	AWG16 (1.25 mm ²)	M6	2.7 to 3.0
	Main Circuit Power Supply Cables	B1/⊕, ⊖2	AWG3 (30 mm ²)	M6	2.7 to 3.0
	Ground Cable	⊕	AWG14 (2.0 mm ²) min.	M6	2.7 to 3.0
780A	Servomotor Main Circuit Cables	U, V, W	AWG3 (30 mm ²)	M6	2.7 to 3.0
	Control Power Supply Cables	L1C, L2C	AWG16 (1.25 mm ²)	M6	2.7 to 3.0
	Main Circuit Power Supply Cables	B1/⊕, ⊖2	AWG3 (30 mm ²)	M6	2.7 to 3.0
	Ground Cable	⊕	AWG14 (2.0 mm ²) min.	M6	2.7 to 3.0

*1. Do not wire the following terminals: L1, L2, L3, B2, B3, ⊕1, and ⊖ terminals.

*2. If you do not use the recommended Servomotor Main Circuit Cable, use this table to select wires.

Three-phase, 200-VAC Wires for Σ -7W SERVOPACKs

SERVOPACK Model: SGD7W-	Terminals		Wire Size	Screw Size	Tightening Torque [N·m]
1R6A	Main Circuit Power Supply Cable	L1, L2, L3	AWG16 (1.25 mm ²)	-	-
	Servomotor Main Circuit Cable*	UA, VA, WA, UB, VB, WB			
	Control Power Supply Cable	L1C, L2C			
	External Regenerative Resistor Cable	B1/⊕, B2			
	Ground cable	⊕	AWG14 (2.0 mm ²) min.	M4	1.2 to 1.4
2R8A	Main Circuit Power Supply Cable	L1, L2, L3	AWG14 (2.0 mm ²)	-	-
	Servomotor Main Circuit Cable*	UA, VA, WA, UB, VB, WB	AWG16 (1.25 mm ²)		
	Control Power Supply Cable	L1C, L2C			
	External Regenerative Resistor Cable	B1/⊕, B2			
	Ground cable	⊕	AWG14 (2.0 mm ²) min.	M4	1.2 to 1.4
5R5A	Main Circuit Power Supply Cable	L1, L2, L3	AWG14 (2.0 mm ²)	-	-
	Servomotor Main Circuit Cable*	UA, VA, WA, UB, VB, WB	AWG16 (1.25 mm ²)		
	Control Power Supply Cable	L1C, L2C			
	External Regenerative Resistor Cable	B1/⊕, B2			
	Ground cable	⊕	AWG14 (2.0 mm ²) min.	M4	1.2 to 1.4
7R6A	Main Circuit Power Supply Cable	L1, L2, L3	AWG14 (2.0 mm ²)	-	-
	Servomotor Main Circuit Cable*	UA, VA, WA, UB, VB, WB	AWG16 (1.25 mm ²)		
	Control Power Supply Cable	L1C, L2C			
	External Regenerative Resistor Cable	B1/⊕, B2			
	Ground cable	⊕	AWG14 (2.0 mm ²) min.	M4	1.2 to 1.4

* If you do not use the recommended Servomotor Main Circuit Cable, use this table to select wires.

Single-phase, 200-VAC Wires for Σ -7W SERVOPACKs

SERVOPACK Model: SGD7W-	Terminals		Wire Size	Screw Size	Tightening Torque [N·m]
1R6A	Main Circuit Power Supply Cable	L1, L2, L3	AWG16 (1.25 mm ²)	-	-
	Servomotor Main Circuit Cable*	UA, VA, WA, UB, VB, WB			
	Control Power Supply Cable	L1C, L2C			
	External Regenerative Resistor Cable	B1/⊕, B2			
	Ground cable	⊕	AWG14 (2.0 mm ²) min.	M4	1.2 to 1.4
2R8A	Main Circuit Power Supply Cable	L1, L2, L3	AWG14 (2.0 mm ²)	-	-
	Servomotor Main Circuit Cable*	UA, VA, WA, UB, VB, WB	AWG16 (1.25 mm ²)		
	Control Power Supply Cable	L1C, L2C			
	External Regenerative Resistor Cable	B1/⊕, B2			
	Ground cable	⊕	AWG14 (2.0 mm ²) min.	M4	1.2 to 1.4
5R5A	Main Circuit Power Supply Cable	L1, L2, L3	AWG14 (2.0 mm ²)	-	-
	Servomotor Main Circuit Cable*	UA, VA, WA, UB, VB, WB	AWG16 (1.25 mm ²)		
	Control Power Supply Cable	L1C, L2C			
	External Regenerative Resistor Cable	B1/⊕, B2			
	Ground cable	⊕	AWG14 (2.0 mm ²) min.	M4	1.2 to 1.4

* If you do not use the recommended Servomotor Main Circuit Cable, use this table to select wires.

DC Power Supply Wires for Σ -7W SERVOPACKs

SERVOPACK Model: SGD7W-	Terminal* ¹		Wire Size	Screw Size	Tightening Torque [N·m]
1R6A	Servomotor Main Circuit Cables	UA, VA, WA, UB, VB, WB* ²	AWG16 (1.25 mm ²)	–	–
	Control Power Supply Cables	L1C, L2C	AWG16 (1.25 mm ²)	–	–
	Main Circuit Power Supply Cables	B1/⊕, ⊖2	AWG16 (1.25 mm ²)	–	–
	Ground Cable	⊕	AWG14 (2.0 mm ²) min.	M4	1.2 to 1.4
2R8A	Servomotor Main Circuit Cables	UA, VA, WA, UB, VB, WB* ²	AWG16 (1.25 mm ²)	–	–
	Control Power Supply Cables	L1C, L2C	AWG16 (1.25 mm ²)	–	–
	Main Circuit Power Supply Cables	B1/⊕, ⊖2	AWG16 (1.25 mm ²)	–	–
	Ground Cable	⊕	AWG14 (2.0 mm ²) min.	M4	1.2 to 1.4
5R5A	Servomotor Main Circuit Cables	UA, VA, WA, UB, VB, WB* ²	AWG16 (1.25 mm ²)	–	–
	Control Power Supply Cables	L1C, L2C	AWG16 (1.25 mm ²)	–	–
	Main Circuit Power Supply Cables	B1/⊕, ⊖2	AWG14 (2.0 mm ²)	–	–
	Ground Cable	⊕	AWG14 (2.0 mm ²) min.	M4	1.2 to 1.4
7R6A	Servomotor Main Circuit Cables	UA, VA, WA, UB, VB, WB* ²	AWG16 (1.25 mm ²)	–	–
	Control Power Supply Cables	L1C, L2C	AWG16 (1.25 mm ²)	–	–
	Main Circuit Power Supply Cables	B1/⊕, ⊖2	AWG14 (2.0mm ²)	–	–
	Ground Cable	⊕	AWG14 (2.0 mm ²) min.	M4	1.2 to 1.4

*1. Do not wire the following terminals: L1, L2, L3, B2, B3, ⊕1, and ⊖ terminals.

*2. If you do not use the recommended Servomotor Main Circuit Cable, use this table to select wires.

Three-phase, 200-VAC Wires for Σ -7C SERVOPACKs

SERVOPACK Model: SGM7C-	Terminals		Wire Size	Screw Size	Tightening Torque [N·m]
1R6A	Main Circuit Power Supply Cable	L1, L2, L3	AWG16 (1.25 mm ²)	-	-
	Servomotor Main Circuit Cable*	UA, VA, WA, UB, VB, WB			
	Control Power Supply Cable	L1C, L2C			
	External Regenerative Resistor Cable	B1/⊕, B2			
	Ground cable	⊕	AWG14 (2.0 mm ²) min.	M4	1.2 to 1.4
2R8A	Main Circuit Power Supply Cable	L1, L2, L3	AWG14 (2.0 mm ²)	-	-
	Servomotor Main Circuit Cable*	UA, VA, WA, UB, VB, WB	AWG16 (1.25 mm ²)		
	Control Power Supply Cable	L1C, L2C			
	External Regenerative Resistor Cable	B1/⊕, B2			
	Ground cable	⊕	AWG14 (2.0 mm ²) min.	M4	1.2 to 1.4
5R5A	Main Circuit Power Supply Cable	L1, L2, L3	AWG14 (2.0 mm ²)	-	-
	Servomotor Main Circuit Cable*	UA, VA, WA, UB, VB, WB	AWG16 (1.25 mm ²)		
	Control Power Supply Cable	L1C, L2C			
	External Regenerative Resistor Cable	B1/⊕, B2			
	Ground cable	⊕	AWG14 (2.0 mm ²) min.	M4	1.2 to 1.4
7R6A	Main Circuit Power Supply Cable	L1, L2, L3	AWG14 (2.0 mm ²)	-	-
	Servomotor Main Circuit Cable*	UA, VA, WA, UB, VB, WB	AWG16 (1.25 mm ²)		
	Control Power Supply Cable	L1C, L2C			
	External Regenerative Resistor Cable	B1/⊕, B2			
	Ground cable	⊕	AWG14 (2.0 mm ²) min.	M4	1.2 to 1.4

* If you do not use the recommended Servomotor Main Circuit Cable, use this table to select wires.

Single-phase, 200-VAC Wires for Σ -7C SERVOPACKs

SERVOPACK Model: SGM7C-	Terminals		Wire Size	Screw Size	Tightening Torque [N·m]
1R6A	Main Circuit Power Supply Cable	L1, L2, L3	AWG16 (1.25 mm ²)	-	-
	Servomotor Main Circuit Cable*	UA, VA, WA, UB, VB, WB			
	Control Power Supply Cable	L1C, L2C			
	External Regenerative Resistor Cable	B1/⊕, B2			
	Ground cable	⊕	AWG14 (2.0 mm ²) min.	M4	1.2 to 1.4
2R8A	Main Circuit Power Supply Cable	L1, L2, L3	AWG14 (2.0 mm ²)	-	-
	Servomotor Main Circuit Cable*	UA, VA, WA, UB, VB, WB	AWG16 (1.25 mm ²)		
	Control Power Supply Cable	L1C, L2C			
	External Regenerative Resistor Cable	B1/⊕, B2			
	Ground cable	⊕	AWG14 (2.0 mm ²) min.	M4	1.2 to 1.4
5R5A	Main Circuit Power Supply Cable	L1, L2, L3	AWG14 (2.0 mm ²)	-	-
	Servomotor Main Circuit Cable*	UA, VA, WA, UB, VB, WB	AWG16 (1.25 mm ²)		
	Control Power Supply Cable	L1C, L2C			
	External Regenerative Resistor Cable	B1/⊕, B2			
	Ground cable	⊕	AWG14 (2.0 mm ²) min.	M4	1.2 to 1.4

* If you do not use the recommended Servomotor Main Circuit Cable, use this table to select wires.

Wire Types

The following table shows the wire sizes and allowable currents for three bundled leads.

HIV Specifications*		Allowable Current at Surrounding Air Temperatures [Arms]		
Nominal Cross-sectional Area [mm ²]	Configuration [Wires/mm]	30°C	40°C	50°C
0.9	7/0.4	15	13	11
1.25	7/0.45	16	14	12
2.0	7/0.6	23	20	17
3.5	7/0.8	32	28	24
5.5	7/1.0	42	37	31
8.0	7/1.2	52	46	39
14.0	7/1.6	75	67	56
22.0	7/2.0	98	87	73
38.0	7/2.6	138	122	103

* This is reference data based on JIS C3317 600-V-grade heat-resistant polyvinyl chloride-insulated wires (HIV).





Crimp Terminals and Insulating Sleeves

If you use crimp terminals for wiring, use insulating sleeves. Do not allow the crimp terminals to come close to adjacent terminals or the case.

To comply with UL standards, you must use UL-compliant closed-loop crimp terminals and insulating sleeves for the main circuit terminals. Use the tool recommended by the crimp terminal manufacturer to attach the crimp terminals.

The following tables give the recommended tightening torques, closed-loop crimp terminals, and insulating sleeves in sets. Use the set that is suitable for your model and wire size.

Σ-7S SERVOPACKs with Three-Phase, 200-VAC and DC Power Supply

SERVOPACK Model: SGD7S-	Main Circuit Terminals	Screw Size	Tightening Torque [N·m]	Crimp Terminal Horizontal Width	Recommended Wire Size	Crimp Terminal Model	Crimping Tool	Die	Insulating Sleeve Model
						(From J.S.T. Mfg. Co., Ltd.)			(Tokyo Dip Co., Ltd.)
R70A, R90A, 1R6A, 2R8A, 3R8A, 5R5A, 7R6A, or 120A	Connector								
		M4	1.2 to 1.4	10 mm max.	AWG14 (2.0 mm ²)	R2-4	YHT-2210	–	–
180A or 200A	Terminal block	M4	1.0 to 1.2	7.7 mm max.	AWG10 (5.5 mm ²)	5.5-S4	YHT-2210	–	TP-005
					AWG14 (2.0 mm ²)	2-M4		–	TP-003
					AWG16 (1.25 mm ²)			–	
		M4	1.2 to 1.4	10 mm max.	AWG14 (2.0 mm ²)	R2-4	YHT-2210	–	–
330A	Terminal block	M4	1.0 to 1.2	9.9 mm max.	AWG8 (8.0 mm ²)	8-4NS	YPT-60N	TD-121 TD-111	TP-008
					AWG14 (2.0 mm ²)	R2-4	YHT-2210	–	TP-003
					AWG16 (1.25 mm ²)			–	
		M4	1.2 to 1.4	10 mm max.	AWG14 (2.0 mm ²)	R2-4	YHT-2210	–	–
470A or 550A	Terminal block	M5	2.2 to 2.4	13 mm max.	AWG4 (22 mm ²)	22-S5	YPT-60N	TD-123 TD-112	TP-022
					AWG6 (14 mm ²)	R14-5		TD-122 TD-111	TP-014
					AWG8 (8.0 mm ²)	R8-5		TD-121 TD-111	TP-008
					AWG10 (5.5 mm ²)	R5.5-5	YHT-2210	–	TP-005
					AWG14 (2.0 mm ²)	R2-5		–	TP-003
					AWG16 (1.25 mm ²)			–	
		M5	2.2 to 2.4	12 mm max.	AWG14 (2.0 mm ²)	R2-5	YHT-2210	–	–

Continued on next page.

Continued from previous page.

SERVOPACK Model: SGD7S-	Main Circuit Terminals	Screw Size	Tightening Torque [N·m]	Crimp Terminal Horizontal Width	Recommended Wire Size	Crimp Terminal Model	Crimping Tool	Die	Insulating Sleeve Model
						(From J.S.T. Mfg. Co., Ltd.)			(Tokyo Dip Co., Ltd.)
590A or 780A	Terminal block	M6	2.7 to 3.0	18 mm max.	AWG3 (30 mm ²)	38-S6	YPT-60N	TD-124 TD-112	TP-038
					AWG4 (22 mm ²)	R22-6		TD-123 TD-112	TP-022
					AWG8 (8.0 mm ²)	R8-6		TD-121 TD-111	TP-008
					AWG10 (5.5 mm ²)	R5.5-6	YHT-2210	–	TP-005
					AWG14 (2.0 mm ²)	R2-6		–	TP-003
					AWG16 (1.25 mm ²)			–	
⊕	M6	2.7 to 3.0	12 mm max.	AWG14 (2.0 mm ²)	R2-6	YHT-2210	–	–	

Σ-7S SERVOPACKs with Single-Phase, 200-VAC Power Supply

SERVOPACK Model: SGD7S-	Main Circuit Terminals	Screw Size	Tightening Torque [N·m]	Crimp Terminal Horizontal Width	Recommended Wire Size	Crimp Terminal Model	Crimping Tool	Die	Insulating Sleeve Model
						(From J.S.T. Mfg. Co., Ltd.)			(Tokyo Dip Co., Ltd.)
R70A, R90A, 1R6A, 2R8A, or 5R5A	Connector	–							
	⊕	M4	1.2 to 1.4	10 mm max.	AWG14 (2.0 mm ²)	R2-4	YHT-2210	–	–
120A□□□□008	Terminal block	M4	1.0 to 1.2	7.7 mm max.	AWG14 (2.0 mm ²)	2-M4	YHT-2210	–	TP-003
					AWG16 (1.25 mm ²)			–	
	⊕	M4	1.2 to 1.4	10 mm max.	AWG14 (2.0 mm ²)	R2-4	YHT-2210	–	–

Σ-7S SERVOPACKs with Single-Phase, 100-VAC Power Supply

SERVOPACK Model: SGD7S-	Main Circuit Terminals	Screw Size	Tightening Torque [N·m]	Crimp Terminal Horizontal Width	Recommended Wire Size	Crimp Terminal Model	Crimping Tool	Die	Insulating Sleeve Model
						(From J.S.T. Mfg. Co., Ltd.)			(Tokyo Dip Co., Ltd.)
R70F, R90F, 2R1F, or 2R8F	Connector	–							
	⊕	M4	1.2 to 1.4	10 mm max.	AWG14 (2.0 mm ²)	R2-4	YHT-2210	–	–

Σ-7W SERVOPACKs with Three-Phase, 200-VAC and DC Power Supply

SERVOPACK Model: SGD7W-	Main Circuit Terminals	Screw Size	Tightening Torque [N·m]	Crimp Terminal Horizontal Width	Recommended Wire Size	Crimp Terminal Model	Crimping Tool	Die	Insulating Sleeve Model
						(From J.S.T. Mfg. Co., Ltd.)			(Tokyo Dip Co., Ltd.)
1R6A, 2R8A, 5R5A, or 7R6A	Connector	-							
		M4	1.2 to 1.4	10 mm max.	AWG14 (2.0 mm ²)	R2-4	YHT-2210	-	-

Σ-7W SERVOPACKs with Single-Phase, 200-VAC Power Supply

SERVOPACK Model: SGD7W-	Main Circuit Terminals	Screw Size	Tightening Torque [N·m]	Crimp Terminal Horizontal Width	Recommended Wire Size	Crimp Terminal Model	Crimping Tool	Die	Insulating Sleeve Model
						(From J.S.T. Mfg. Co., Ltd.)			(Tokyo Dip Co., Ltd.)
1R6A, 2R8A, or 5R5A	Connector	-							
		M4	1.2 to 1.4	10 mm max.	AWG14 (2.0 mm ²)	R2-4	YHT-2210	-	-

Σ-7C SERVOPACKs with Three-Phase, 200-VAC and DC Power Supply

SERVOPACK Model: SGM7C-	Main Circuit Terminals	Screw Size	Tightening Torque [N·m]	Crimp Terminal Horizontal Width	Recommended Wire Size	Crimp Terminal Model	Crimping Tool	Die	Insulating Sleeve Model
						(From J.S.T. Mfg. Co., Ltd.)			(Tokyo Dip Co., Ltd.)
1R6A, 2R8A, 5R5A, or 7R6A	Connector	-							
		M4	1.2 to 1.4	10 mm max.	AWG14 (2.0 mm ²)	R2-4	YHT-2210	-	-

Σ-7C SERVOPACKs with Single-Phase, 200-VAC Power Supply

SERVOPACK Model: SGM7C-	Main Circuit Terminals	Screw Size	Tightening Torque [N·m]	Crimp Terminal Horizontal Width	Recommended Wire Size	Crimp Terminal Model	Crimping Tool	Die	Insulating Sleeve Model
						(From J.S.T. Mfg. Co., Ltd.)			(Tokyo Dip Co., Ltd.)
1R6A, 2R8A, or 5R5A	Connector	-							
		M4	1.2 to 1.4	10 mm max.	AWG14 (2.0 mm ²)	R2-4	YHT-2210	-	-

Surge Absorbers (Varistors) and Diodes for Holding Brake Power Supplies

Surge Absorbers (varistors) and Diodes for holding brake power supplies help prevent damage to brake coils caused by voltage surges.

If you use a Servomotor with a Holding Brake and switch the brake power supply circuit on the DC side, connect a Surge Absorber (varistor) or Diode that is suitable for the brake power supply voltage and current.



Note

- When you select a Surge Absorber, varistor, or Diode for your application, consider the service life and test all operations, including the brake timing, before you use the Servomotor.
- If you connect an SSR (i.e., a semiconductor relay) to switch the brake circuit, use a Diode.
- If you connect a Diode, more time is required to brake than with a Surge Absorber. (Refer to the following figure.) If you use a diode, consider this in the application.

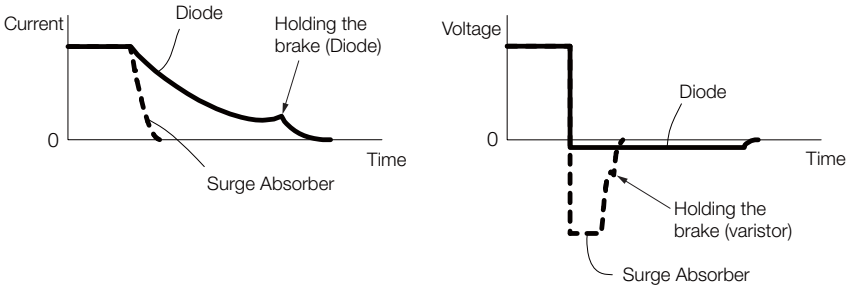

The figure contains two graphs. The left graph plots Current vs. Time. It shows a solid line for 'Diode' and a dashed line for 'Surge Absorber'. Both start at a constant current level. When the brake is released, the current drops. The 'Surge Absorber' curve drops more sharply to zero, while the 'Diode' curve decays more gradually. Labels include 'Diode', 'Holding the brake (Diode)', 'Surge Absorber', and 'Time'. The right graph plots Voltage vs. Time. It shows a solid line for 'Diode' and a dashed line for 'Surge Absorber'. Both start at a constant voltage level. When the brake is released, the voltage drops. The 'Surge Absorber' curve drops more sharply to zero, while the 'Diode' curve decays more gradually. Labels include 'Diode', 'Holding the brake (varistor)', 'Surge Absorber', and 'Time'.

◆ Surge Absorbers (Varistors) for Holding Brake Power Supplies

Use the following table as reference in selecting a Surge Absorber. Elements were selected for a Surge Absorber surrounding air temperature range of -20°C to 60°C and an ON/OFF switching frequency of 10 times or less per minute. The information in this table is for reference only, and does not ensure operation in combination with the holding brake.

Holding Brake Power Supply Voltage		24 VDC	
Manufacturer		Nippon Chemi-Con Corporation	Semitec Corporation
		Order Number	
Brake Rated Current	1 A max.	TNR5V121K	Z5D121
	2 A max.	TNR7V121K	Z7D121
	4 A max.	TNR10V121K	Z10D121
	8 A max.	TNR14V121K	Z15D121

◆ Diodes for Holding Brake Power Supplies

Select a Diode for the holding brake power supply with a rated current that is greater than that of the holding brake and with the recommended withstand voltage given in the following table.

Diodes are not provided by Yaskawa.

Holding Brake Power Supply Unit Specifications		Withstand Voltage
Rated Output Voltage	Input Voltage	
24 VDC	200 V	100 V to 200 V

Regenerative Resistors

Types of Regenerative Resistors

The following regenerative resistors can be used.

- Built-in regenerative resistors: Some models of SERVOPACKs have regenerative resistors built into them.
- External regenerative resistors: These resistors are used when the smoothing capacitor and built-in regenerative resistor in the SERVOPACK cannot consume all of the regenerative power. Use Yaskawa's SigmaSize+, an AC Servo drive capacity selection program, to determine if a regenerative resistor is required.

Note: If you use an External Regenerative Resistor, you must change the setting of the Pn600 (Regenerative Resistor Capacity) or Pn603 (Regenerative Resistance) parameters.

Selection Table

SERVOPACK Model			Built-In Regenerative Resistor	External Regenerative Resistor	Contents
SGD7S-	SGD7W-	SGD7C-			
R70A, R90A, 1R6A, 2R8A, R70F, R90F, 2R1F, 2R8F	–	–	None	Basically not required	There is no built-in regenerative resistor, but normally an external regenerative resistor is not required. Install an external regenerative resistor when the smoothing capacitor in the SERVOPACK cannot process all the regenerative power.*1
3R8A, 5R5A, 7R6A, 120A, 180A, 200A, 330A	1R6A, 2R8A, 5R5A, 7R6A	1R6A, 2R8A, 5R5A, 7R6A	Standard feature*2	Basically not required	A built-in regenerative resistor is provided as a standard feature. Install an external regenerative resistor when the built-in regenerative resistor cannot process all the regenerative power.*1
470A, 550A, 590A, 780A	–	–	None	Required.*3	A built-in regenerative resistor is not provided. An External Regenerative Resistor is required. If the External Regenerative Resistor is not connected to the SERVOPACK, a Regeneration Alarm (A.300) will occur.

*1. Use Yaskawa's SigmaSize+, an AC Servo drive capacity selection program, to select an external regenerative resistor.

*2. Refer to the following section for the specifications of built-in regenerative resistors.

 [Built-In Regenerative Resistor \(page 472\)](#)

*3. Regenerative Resistor Units are available. Refer to the following sections for details.

 [Regenerative Resistor Units \(page 473\)](#)

Built-In Regenerative Resistor

The following table gives the specifications of the built-in regenerative resistors in the SERVOPACKs and the amount of regenerative power (average values) that they can process.

SERVOPACK Model			Built-In Regenerative Resistor		Regenerative Power Processing Capacity of Built-In Regenerative Resistor [W]	Minimum Allowable Resistance [Ω]
SGD7S-	SGD7W-	SGD7C-	Resistance [Ω]	Capacity [W]		
R70A, R90A, 1R6A, 2R8A, R70F, R90F, 2R1F, 2R8F	–	–	–	–	–	40
3R8A, 5R5A, 7R6A	1R6A, 2R8A	1R6A, 2R8A	40	40	8	40
120A	–	–	20	60	10	20
120A□□□008, 180A, 200A	5R5A, 7R6A	5R5A, 7R6A	12	60	16	12
330A	–	–	8	180	36	8
470A	–	–	(6.25) ^{*1}	(880) ^{*1}	(180) ^{*1}	5.8
550A, 590A, 780A	–	–	(3.13) ^{*2}	(1760) ^{*2}	(350) ^{*2}	2.9

*1. Values in parentheses are for the optional JUSP-RA04-E Regenerative Resistor Unit.

*2. Values in parentheses are for the optional JUSP-RA05-E Regenerative Resistor Unit.

External Regenerative Resistors

Model	Specification	Mass	Wire Size	Manufacturer	Inquiries
RH120	70 W, 1 Ω to 100 Ω	282 g	AWG16 (1.25 mm ²)	Iwaki Musen Kenkyusho Co., Ltd.	Yaskawa Controls Co., Ltd.
RH150	90 W, 1 Ω to 100 Ω	412 g	AWG16 (1.25 mm ²)		
RH220	120 W, 1 Ω to 100 Ω	500 g	AWG16 (1.25 mm ²)		
RH220B	120 W, 1 Ω to 100 Ω	495 g	AWG14 (2.0 mm ²)		
RH300C	200 W, 1 Ω to 10 kΩ	850 g	AWG14 (2.0 mm ²)		
RH450	150 W, 1 Ω to 100 Ω	880 g	AWG14 (2.0 mm ²)		
RH450FY	150 W, 2 Ω to 100 Ω	1.3 kg	AWG14 (2.0 mm ²)		
RH500	300 W, 2 Ω to 50 Ω	1.4 kg	AWG14 (2.0 mm ²)		

Note: 1. Consult Yaskawa Controls Co., Ltd. if you require a RoHS-compliant resistor.

2. Consult Yaskawa Controls Co., Ltd. for the model numbers and specifications of resistors with Thermal Protector.

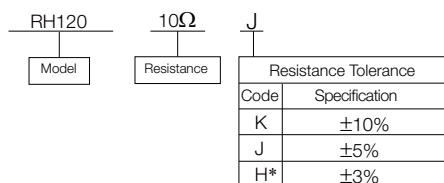

* There is no RH450FY model that has a resistance tolerance of H (±3%).

Regenerative Resistor Units

SERVOPACK Model: SGD7S-	Regenerative Resistor Unit Model	Specifications	Allowable Power Loss
470A	JUSP-RA04-E	6.25 Ω , 880 W	180 W
550A, 590A, or 780A	JUSP-RA05-E	3.13 Ω , 1,760 W	350 W

Note: If you use only the above Regenerative Resistor Units, you do not need to change the setting of the Pn600 (Regenerative Resistor Capacity) or Pn603 (Regenerative Resistance) parameters.

◆ External Dimensions

■ JUSP-RA04-E

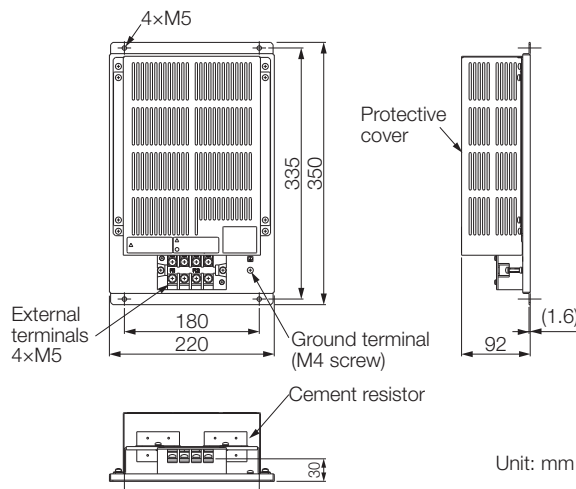

■ JUSP-RA05-E

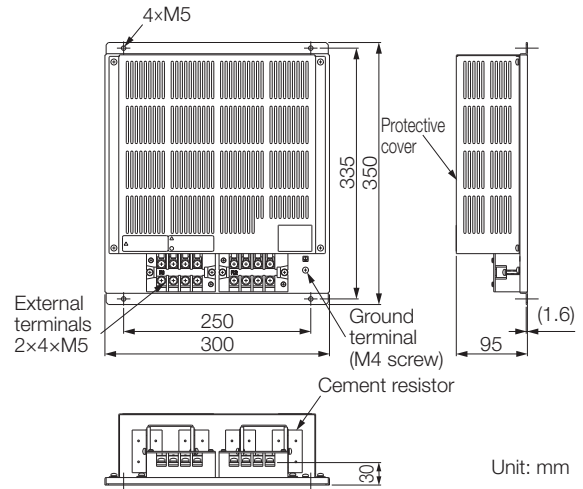

Batteries for Servomotors with Absolute Encoders

If you use an absolute encoder, you can use an Encoder Cable with a Battery Case connected to it to supply power and retain the absolute position data.

You can also retain the absolute position data by supplying power from a battery on the host controller.

Note: A Battery Case is not required if you use a Servomotor with a Batteryless Absolute Encoder and connect a battery to the host controller.

Using Encoder Cables with Battery Cases

A Battery Case is attached to an Encoder Cable with a Battery Case. To replace the battery, obtain a Lithium Battery (JZSP-BA01) and mount it in the Battery Case.



1. You cannot attach the Battery Case to an Incremental Encoder Cable.
2. Install the Battery Case where the surrounding air temperature is between -5°C and 60°C.

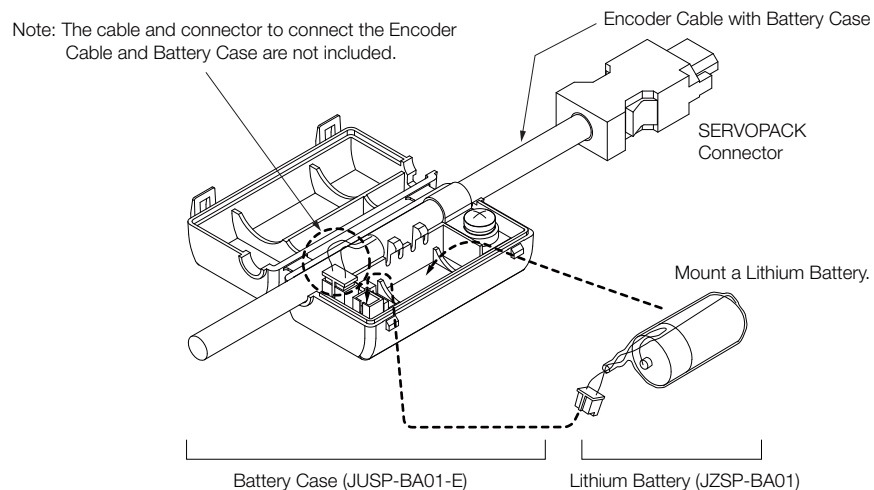

◆ Selection Table

Name	Order Number	Remarks
Battery Case (case only)	JZSP-BA01-E	The Encoder Cable and Battery are not included. (This is a replacement part for a damaged Battery Case.)
Lithium Battery	JZSP-BA01	This is a special battery that is mounted into the Battery Case.

◆ Lithium Battery Dimensional Drawing

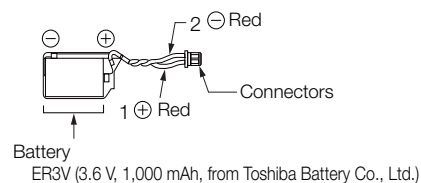

When Installing a Battery on the Host Controller

Use a battery that meets the specifications of the host controller.

Use the recommended Battery given in the following table or the equivalent.

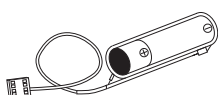

Inrush Current Suppression Devices

Inrush current suppression devices prevent equipment from being damaged by inrush current.

They are used only when using a SERVOPACK of 5 kW or higher (SGD7S-330A, -470A, -550A, -590A, or -780A) with a DC power supply input.

Selection Table

◆ External Inrush Current Suppression Resistors

Main Circuit Power Supply	SERVO-PACK Model: SGD7S-	External Inrush Current Suppression Resistor			Manufacturer	Inquiries
		Order Number	Resistance [Ω]	Rated Power [W]		
270 VDC	330A	RH120-5 Ω J	5	70	Iwaki Musen Kenkyusho Co., Ltd.	Yaskawa Controls Co., Ltd.
	470A					
	550A					
	590A	RH120-3 Ω J	3			
	780A					

◆ Inrush Current Suppression Resistor Short Relays

Main Circuit Power Supply	SERVO-PACK Model: SGD7S-	Main Circuit DC Current [Arms]	Contact Specification	Recommended Inrush Current Suppression Resistor Short Relay			Manufacturer
				Model	Voltage Rating [Vdc]	Current Rating [A]	
270 VDC	330A	34	NO	G9EA-1-B G9EA-1-B-CA G9EA-1-B-CA* ¹ G9EC-1-B* ²	400	60	OMRON Corporation
	470A	36				100	
	550A	48				200	
	590A	68					
	780A	92					

*1. Connect two Relays in parallel. Also, maintain the same resistance between the DC power supply and SERVOPACK for the wiring for each Relay.

*2. This Relay is applicable only when the temperature of the Relay installation environment is 50°C or less.

Software

SigmaSize+: AC Servo Capacity Selection Program

You can use the SigmaSize+ to select Servomotors and SERVOPACKs. There are two versions of the software: A cloud version* and a stand-alone version.

The software supports all standard servo products sold by Yaskawa.

* SigmaSize+ is available in Japan only. Contact your Yaskawa representative for information on this program.

◆ Features

- Provides a vast amount of new product information.
- Lets you select servo products with a wizard.
- You can access and reuse previously entered data.

■ Examples of the Servo Selection Interface

Mechanism Selection View



Machine Specification Entry View

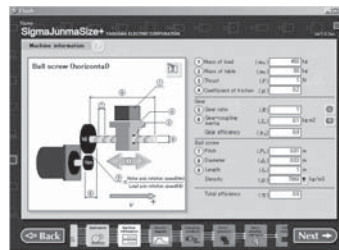

Speed Diagram Entry View



Operating Conditions Selection View

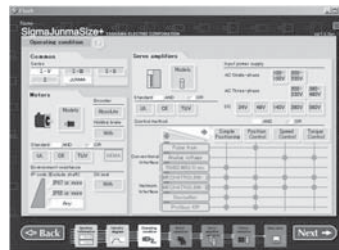

Servomotor Selection View



SERVOPACK Selection View



◆ System Requirements

Item	System Requirement
Browser	Internet Explorer version 10 or later
OS	Windows Vista or Windows 7 (32-bit or 64-bit edition)*
CPU	Pentium 200 MHz min.
Memory	64 MB min. (96 MB or greater recommended)
Available Hard Disk Space	20 MB min.

* 64-bit OS is applicable only for the stand-alone version.

SigmaWin+: AC Servo Drive Engineering Tool

The SigmaWin+ Engineering Tool is used to set up and optimally tune Yaskawa Σ -series Servo Drives.

◆ Features

- Set parameters with a wizard.
- Display SERVOPACK data on a computer just like you would on an oscilloscope.
- Estimate moments of inertia and measure vibration frequencies.
- Display alarms and alarm diagnostics.

Setting Parameters with a Wizard

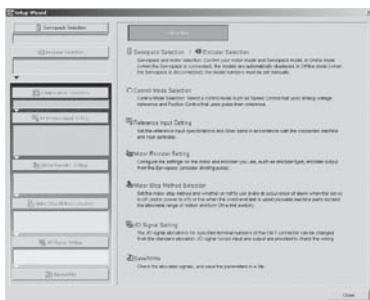

Displaying SERVOPACK Data on a Computer Just Like You Would on an Oscilloscope

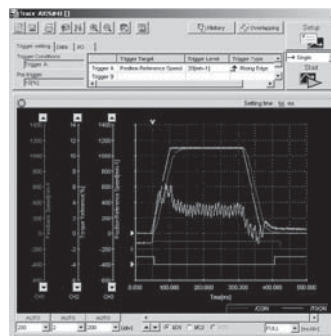

Estimating Moments of Inertia and Measuring Vibration Frequencies

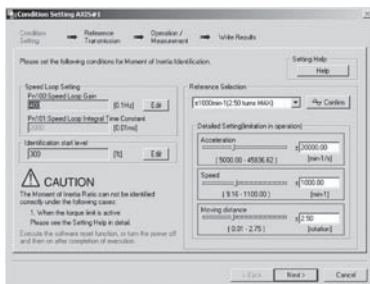

Displaying Alarms and Alarm Diagnostics

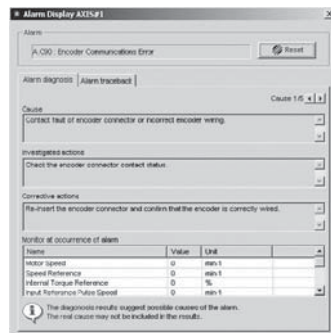

◆ System Requirements

Item	System Requirement	
	Ver.5	Ver.7
Supported Languages	English and Japanese	Japanese, English, and Chinese (simplified)
OS	Windows XP, Windows Vista, or Windows 7 (32-bit or 64-bit edition)	Windows 10, Windows 8, Windows 8.1, or Windows 7 (32-bit or 64-bit edition)
Software Environment	–	.NET Framework 4.5, .NET Framework 4.6
CPU	Pentium 200 MHz min.	1 GHz min. (recommended)
Memory	64 MB min. (96 MB or greater recommended)	1 GB min. (recommended)
Available Hard Disk Space	For Standard Setup: 350 MB min. (400 MB or greater recommended for installation)	500 MB min.
Browser used to display Help	–	Internet Explorer 9 or higher

MPE720 System Integrated Engineering Tool

MPE720 Ver.7 is a system integrated Engineering Tool that provides the complete development functionality to set up, adjust, program, maintain, and inspect not only Controller programs but also all of the devices necessary to design machine installations, including Servo Drives, AC Drives, and Distributed I/O Devices.

It is installed in a PC and operated on a PC interface through a connection between the PC and Machine Controller.

◆ Features

■ Complete Adjustment and Maintenance of Equipment Drive Devices

MPE720 Ver.7 connected to the Σ -7C or MP series machine controllers can be used to set up, adjust, and maintain Servo Drives, AC Drives, and I/O Devices connected to a network. There is no need to change connections, which increases efficiency.

■ Greater Efficiency with the Best Programming Method

Ladder Programming



Motion Programming

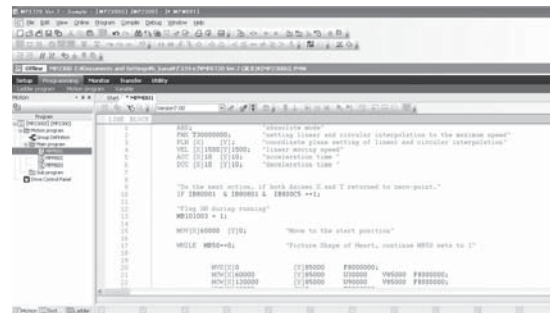

- The new user interface lets just about anyone easily use the MPE720.
- An improved EXPRESSION instruction simplifies programming calculation in ladder diagrams.
- Support is provided for all types of control, including position, speed, torque, and phase control.
- Positioning and interpolation can be programmed with one instruction.
- Programs can be very easily edited using expressions in a text format.
- New variable programming can provide PC-like programming.

◆ System Requirements

Item	Specification
CPU	1 GHz or more recommended (manufactured by Intel or other companies)
Memory Capacity	1 GB or more recommended*
Available Hard Disk Space	700 MB or more (includes standard workspace memory after installation of MPE720)
Display Resolution	1280 × 800 pixels or more recommended
CD Drive	1 (only for installation)
Communications Ports	RS-232C, Ethernet, MP2100 bus, and USB
OS	Windows 10, Windows 8, Windows 8.1, or Windows 7 (32-bit or 64-bit)
.NET Environment	.NET Framework 4.5
Supported Languages	English and Japanese

* Expand memory if other application programs are run simultaneously with MPE720 on the same computer. Performance may be slow due to the use of memory by multiple application programs that are run simultaneously.

Option Modules

■ Features

Feedback Option Module



Fully-Closed Module 480

- High-precision and high-response positioning by using feedback from detector (such as an external encoder) installed on the machine.
- High resolution with external encoders (linear scales).

Safety Option Module



Safety Module 486

- Safety functions equivalent to those stipulated in international standard: IEC Safe Torque Off (STO), Safe Stop 1 (SS1), Safe Stop 2 (SS2), Safely-Limited Speed (SLS)
- Two safety functions (A and B) provided. Stopping functions can be allocated individually to these safety functions.
- Monitoring times can be changed using parameters.

Fully-Closed Module

Safety Module

Feedback Option Module

Fully-Closed Module

With a Fully-Closed Module, an externally installed encoder is used to detect the position of the controlled machine and the machine's position information is fed back to the SERVOPACK to implement controls. High-precision positioning is possible because the actual machine position is fed back directly. To perform fully-closed loop control, a Fully-Closed Module and SERVOPACK are required.

Model Designations

◆ Purchasing a Module in a Set with the SERVOPACK

To order SERVOPACKs with a Fully-Closed Module attached, use the following model numbers.



1st+2nd+3rd digits			4th digit		8th+9th+10th digits		
Maximum Applicable Motor Capacity			Voltage		Hardware Options Specification		
Three-phase, 200 VAC	Code	Specification	Code	Specification	000	Without options	All models
	R70 ^{*2}	0.05 kW	A	200 VAC		001	Rack-mounted
	R90 ^{*2}	0.1 kW	F	100 VAC	SGD7S-R70F to -2R8F		
	1R6 ^{*2}	0.2 kW	5th+6th digits Interface		002	Duct-ventilated	SGD7S-470A to -780A
	2R8 ^{*2}	0.4 kW					
	3R8	0.5 kW	Code	Specification	008	Single-phase, 200-VAC power supply input	SGD7S-120A
	5R5 ^{*2}	0.75 kW	00	Analog voltage/pulse train reference			
	7R6	1.0 kW	10	MECHATROLINK-II communications reference	020 ^{*3}	No dynamic brake	SGD7S-R70A to -2R8A
	120	1.5 kW	20	MECHATROLINK-III communications reference			SGD7S-R70F to -2R8F
	180	2.0 kW	7th digit Design Revision Order				External dynamic brake resistor
	200	3.0 kW			A		
	330	5.0 kW	11th+12th+13th digits		Option Module		
	470	6.0 kW			Code	Specification	
550	7.5 kW	001	Fully-Closed Module				
590	11 kW	Single-phase, 100 VAC					
780	15 kW						
R70	0.05 kW						
R90	0.1 kW						
2R1	0.2 kW						
2R8	0.4 kW						

*1. The model number of a SERVOPACK with an Option Module is not hyphenated after SGD7S.

*2. You can use these models with either a single-phase or three-phase power supply input.

*3. Refer to the following manual for details.

Σ-7-Series AC Servo Drive Σ-7S/Σ-7W SERVOPACK with Hardware Option Specifications Dynamic Brake Product Manual (Manual No.: SIEP S800001 73)

Note: Contact your Yaskawa representative for information on combining options.

◆ Purchasing a Module Separately

When ordering a SERVOPACK and a Fully-Closed Module separately, use the following Fully-Closed Module model number.

SGDV-OFA01A



- One Option Case Kit is required for each SERVOPACK.
Option Case Kit model: SGDV-OZA01A
- Refer to the following pages when using these Command Option Modules with Fully-Closed Module.
 - INDEXER Module: Page 356
 - DeviceNet Module: Page 370

System Configuration

Refer to the section for the relevant Servomotor for information on Servomotor Main Circuit Cables. To select an External Linear Encoder, refer to *Recommended Linear Encoders* (page 308). The connection devices and cables for each type of encoder are also given. Prepare the required items.

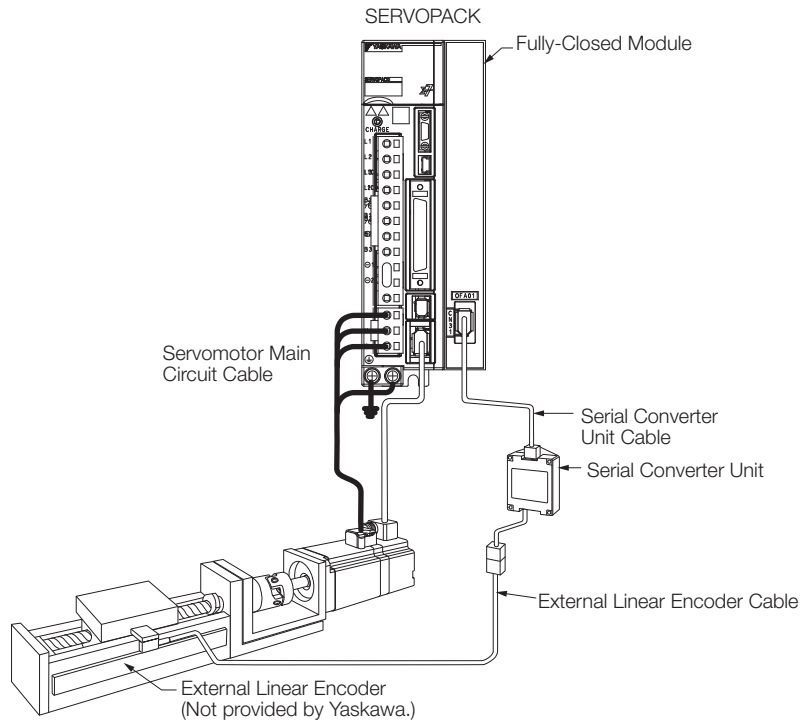

Note: 1. Refer to the following section for information on peripheral devices.

 *Peripheral Devices* (page 448)

2. If you purchase a Fully-Closed Module by itself, refer to the following manual for the method to mount it to the SERVOPACK.

 *Σ -V Series/ Σ -V Series for Large-Capacity Models/ Σ -7 Series Installation Guide Fully-Closed Module* (Manual No.: TOBP C720829 03)

◆ Connections to Linear Encoder from Heidenhain Corporation

■ Connections for a 1 Vp-p Analog Voltage Output Signal

You must make the connections through a Yaskawa Serial Converter Unit. The output signal will be multiplied by 8 bits (256 divisions) in the Serial Converter Unit.

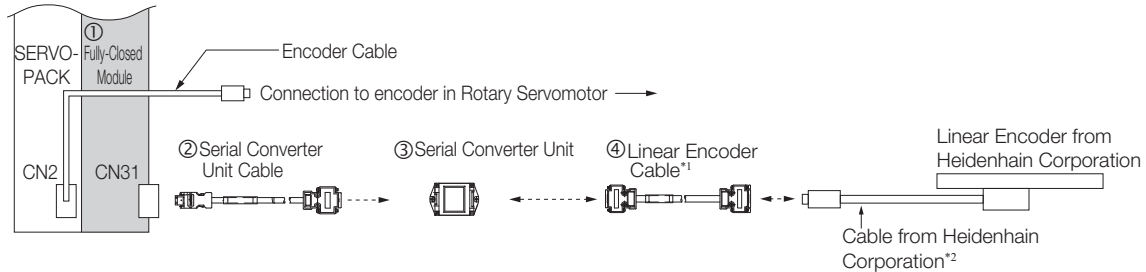

*1. When using a JZDP-J00□-□□□ Serial Converter Unit, do not use a Yaskawa Linear Encoder Cable that is longer than 3 m.

*2. Contact Heidenhain Corporation for details on cables (analog 1 Vp-p output, D-sub 15-pin, male) from Heidenhain Corporation.

No.	Item	Model
①	Fully-Closed Module (Purchased as a set with the SERVOPACK)	Without options: SGD7S□□□□0A00□□1 With options:SGD7S□□□□0A■■■□□1 Note: When a hardware option is mounted, ■■■ is replaced with a three-digit number that specifies the type of option.
	Fully-Closed Module (Purchased alone)	Fully-Closed Module SGD7V-OFA01A Option Case Kit*1 SGD7V-OZA01A
②	Serial Converter Unit Cable	JZSP-CLP70-□□-E*3
③	Serial Converter Unit*2	JZDP-H003-000
④	Linear Encoder Cable	JZSP-CLL30-□□-E*3

*1. One Option Case Kit is required for each SERVOPACK.

The set includes the module cover, PCB mounting plate, and two mounting screws.

*2. Refer to the following manual for the specifications of the Serial Converter Units.

📖 *Σ-7-Series AC Servo Drive Peripheral Device Selection Manual (Manual No.: SIEP S800001 32)*

*3. The boxes (□□) in the model number are replaced with the cable length when ordering.

(1 m = 01, 3 m = 03, 5 m = 05, 10 m = 10, 15 m = 15, and 20 m = 20)

■ Connections When Using a Yaskawa Serial Interface for the Output Signals

- LIC4100 and LC115 Linear Encoder with EIB3391Y Interpolator
or
• RCN□□10, 5□10, and 8□10 Rotary Encoder with EIB3391Y Interpolator

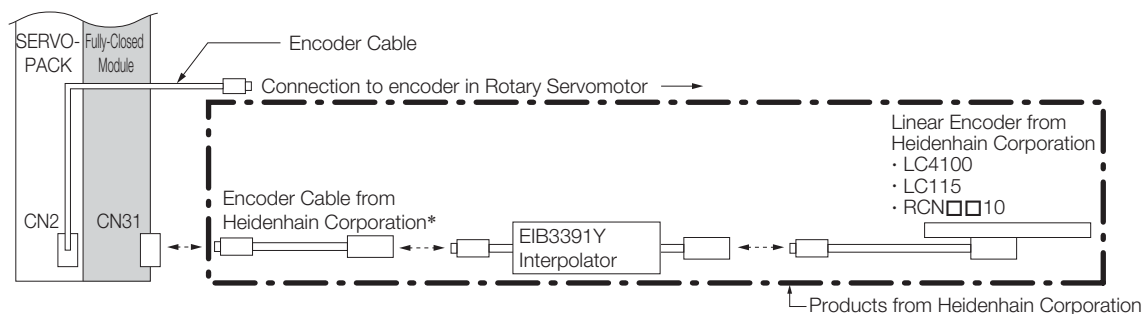

Note: The RCN□□□□ is a single-turn absolute rotary encoder.

* Use an Encoder Cable from Heidenhain Corporation. Contact Heidenhain Corporation for detailed Encoder Cable specifications.

◆ Connections to Linear Encoder from Renishaw Plc

■ Connections for a 1 Vp-p Analog Voltage Output Signal

You must make the connections through a Yaskawa Serial Converter Unit. The output signal will be multiplied by 8 bits (256 divisions) in the Serial Converter Unit.

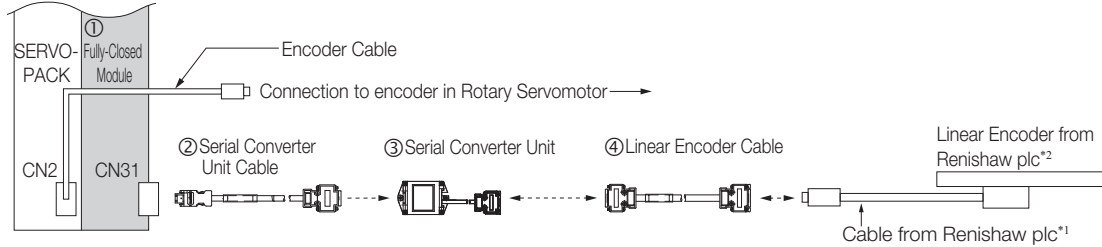

*1. Contact Renishaw plc for details on cables (analog 1 Vp-p output, D-sub 15-pin, male) from Renishaw plc. However, the BID and DIR signals are not connected.

*2. If you use the origin signals with a Linear Encoder from Renishaw plc, the origin may sometimes be falsely detected.

If that occurs, use the BID/DIR signal to output the origin signal only in one direction.

No.	Item	Model
①	Fully-Closed Module (Purchased as a set with the SERVOPACK)	Without options: SGD7S□□□□□□0A000□□1 With options:SGD7S□□□□□□0A■■■□□1 Note: When a hardware option is mounted, ■■■ is replaced with a three-digit number that specifies the type of option.
	Fully-Closed Module (Purchased alone)	Fully-Closed Module SGD7-OFA01A Option Case Kit*1 SGD7-OZA01A
②	Serial Converter Unit Cable	JZSP-CLP70-□□-E*3
③	Serial Converter Unit*2	JZDP-H005-000
④	Linear Encoder Cable	JZSP-CLL00-□□-E*3

*1. When ordering a SERVOPACK and a Fully-Closed Module separately, use this Fully-Closed Module model number.

*2. Refer to the following manual for the specifications of the Serial Converter Units.

📖 *Σ-7-Series AC Servo Drive Peripheral Device Selection Manual* (Manual No.: SIEP S800001 32)

*3. The boxes (□□) in the model number are replaced with the cable length when ordering.
(1 m = 01, 3 m = 03, 5 m = 05, 10 m = 10, 15 m = 15, and 20 m = 20)

■ Connections When Using a Yaskawa Serial Interface for the Output Signals

• EVOLUTE Series Linear Encoder (model: EL36Y-□□□□□□□□)

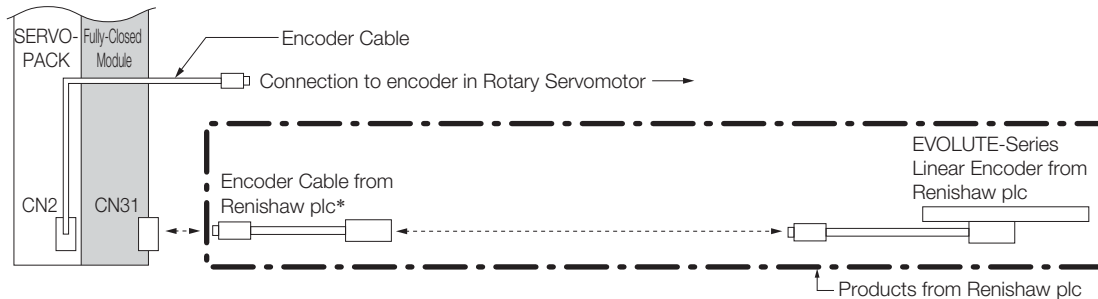

* Use an Encoder Cable from Renishaw plc. Contact Renishaw plc for detailed Encoder Cable specifications.

◆ Connections to Linear Encoder from Magnescale Co., Ltd.

■ SL7□0 Linear Encoder and PL101-RY Sensor Head with Interpolator

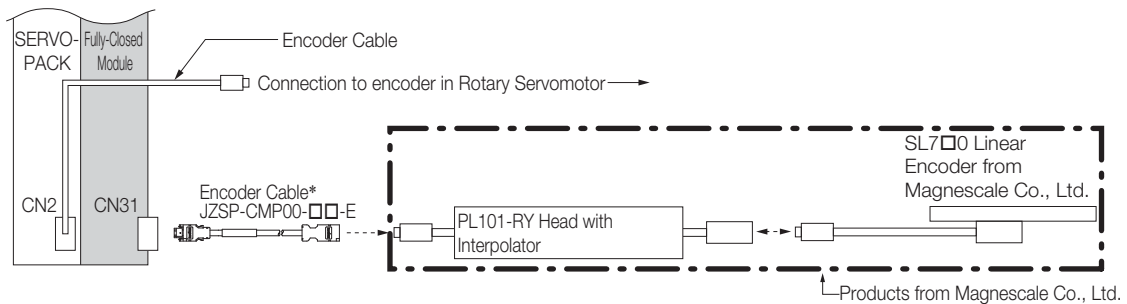

* The boxes (□□) in the model number are replaced with the cable length when ordering.
(3 m = 03, 5 m = 05, 10 m = 10, 15 m = 15, and 20 m = 20)

■ SmartSCALE Linear Encoder (SQ10 Scale + MQ10-FLA Interpolator)

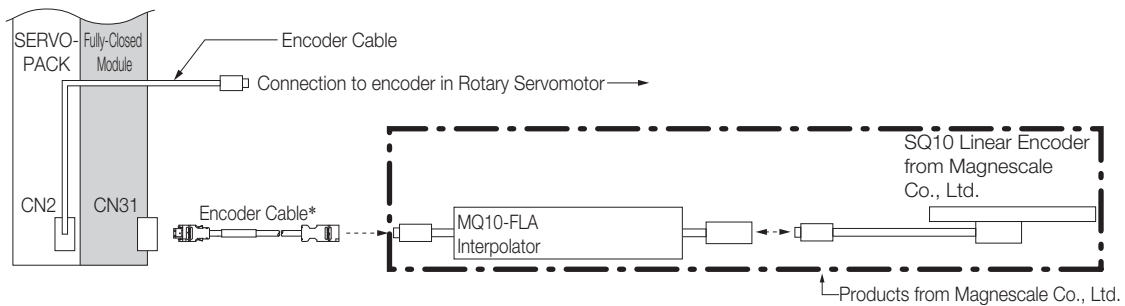

* The maximum cable length in this case is 15 m.
Contact Magnescale Co., Ltd. for detail Encoder Cable specifications.

■ SR-75, SR-77, SR-85, and SR-87 Linear Encoders

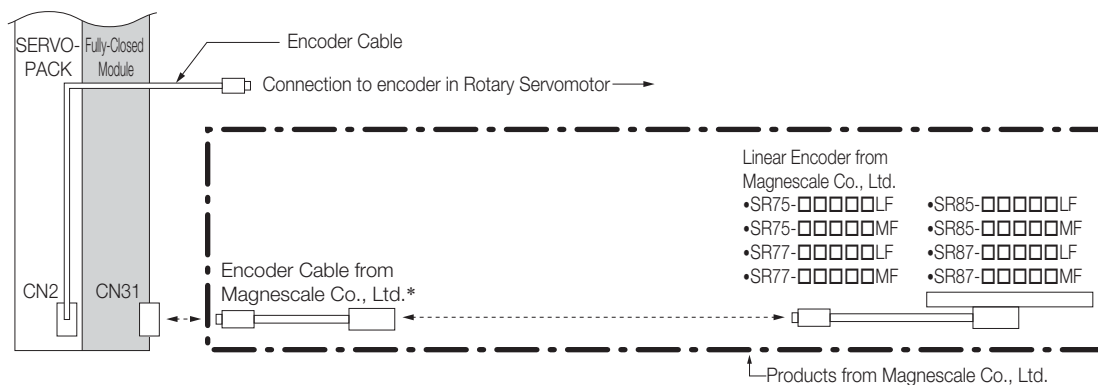

* To connect the SERVOPACK and Linear Encoder, use a CH33-xx□□G Cable from Magnescale Co., Ltd. (This Cable has connectors designed for use with Yaskawa products.)

■ RU77-4096ADF/RU77-4096AFFT01 Absolute Rotary Encoders

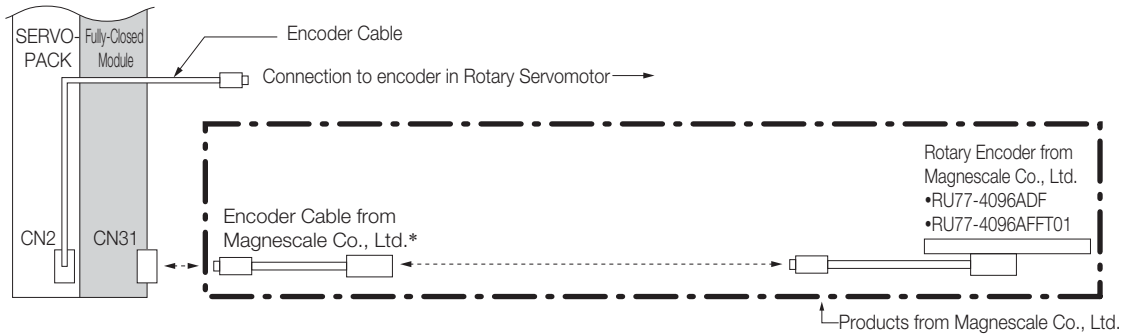

* To connect the SERVOPACK and Rotary Encoder, use a CE28-Series Extension Cable for RU77 from Magnescale Co., Ltd.

Note: The RU77 is a single-turn absolute rotary encoder.

◆ Connections to Linear Encoders from Mitutoyo Corporation

■ ST78□□A/ST13□□□ Linear Encoders

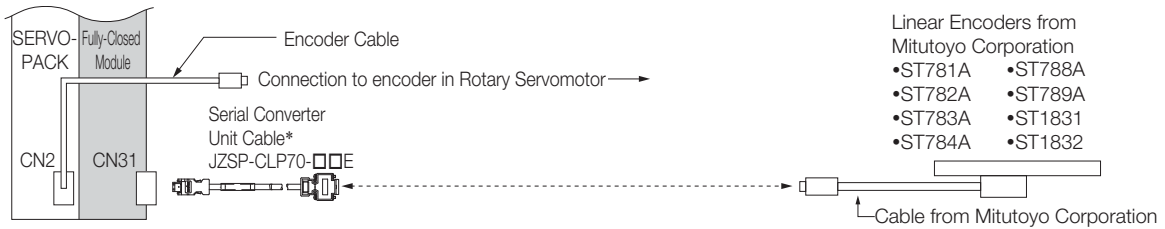

* The boxes (□□) in the model number are replaced with the cable length when ordering.
(1 m = 01, 3 m = 03, 5 m = 05, 10 m = 10, 15 m = 15, and 20 m = 20)

External Dimensions

Refer to pages 436 to 447 for the external dimensions of the individual SERVOPACKs.

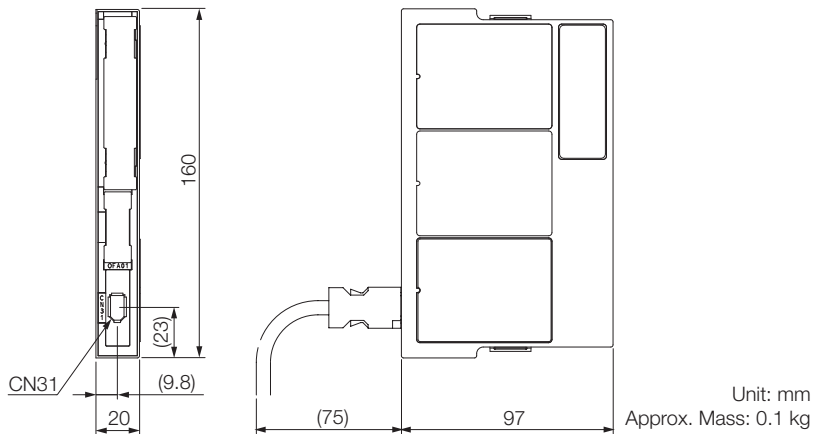

Connectors

Device Label	Model	Number of Pins	Manufacturer
CN31	3E106-0220KV	6	3M Japan Ltd.

Note: The above connectors or their equivalents are used for the Fully-Closed Module.

Safety Option Module

Safety Module

This Safety Module implements safety functions that conform to EN ISO 13849-1 (the harmonized EU Machinery Directive) and are specified in the individual IEC 61800-5-2 standard. You can combine it with an SGD7S SERVOPACK to design optimum safety in a machine system according to industry needs.

Model Designations

◆ Purchasing a Module in a Set with the SERVOPACK

To order SERVOPACKs with a Safety Module attached, use the following model numbers.

SGD7S *1 R70 A 00 A 000 010

Σ-7 Series Σ-7S Models 1st+2nd+3rd digits 4th digit 5th+6th digits 7th digit 8th+9th+10th digits 11th+12th+13th digits

1st+2nd+3rd digits Maximum Applicable Motor Capacity

Voltage	Code	Specification
Three-phase, 200 VAC	R70*2	0.05 kW
	R90*2	0.1 kW
	1R6*2	0.2 kW
	2R8*2	0.4 kW
	3R8	0.5 kW
	5R5*2	0.75 kW
	7R6	1.0 kW
	120	1.5 kW
	180	2.0 kW
	200	3.0 kW
	330	5.0 kW
	470	6.0 kW
	550	7.5 kW
	590	11 kW
	780	15 kW
Single-phase, 100 VAC	R70	0.05 kW
	R90	0.1 kW
	2R1	0.2 kW
	2R8	0.4 kW

4th digit Voltage

Code	Specification
A	200 VAC
F	100 VAC

5th+6th digits Interface

Code	Specification
00	Analog voltage/pulse train reference
10	MECHATROLINK-II communications reference
20	MECHATROLINK-III communications reference

7th digit Design Revision Order
A

8th+9th+10th digits Hardware Options Specification

Code	Specification	Applicable Models
000	Without options	All models
001	Rack-mounted	SGD7S-R70A to -330A SGD7S-R70F to -2R8F
	Duct-ventilated	SGD7S-470A to -780A
002	Varnished	All models
008	Single-phase, 200-VAC power supply input	SGD7S-120A
020*3	No dynamic brake	SGD7S-R70A to -2R8A SGD7S-R70F to -2R8F
	External dynamic brake resistor	SGD7S-3R8A to -780A

11th+12th+13th digits Option Module

Code	Specification
010	Safety Module

*1. The model number of a SERVOPACK with an Option Module is not hyphenated after SGD7S.

*2. You can use these models with either a single-phase or three-phase power supply input.

*3. Refer to the following manual for details.

Σ-7-Series AC Servo Drive Σ-7S/Σ-7W SERVOPACK with Hardware Option Specifications Dynamic Brake Product Manual (Manual No.: SIEP S800001 73)

Note: Contact your Yaskawa representative for information on combining options.

◆ Purchasing a Module Separately

When ordering SERVOPACKs and Safety Modules separately, use the following Safety Module model number.

SGDV-OA01A



Important

- One Option Case Kit is required for each SERVOPACK.
Option Case Kit model: SGDV-OZA01A
- INDEXER Modules and DeviceNet Modules cannot be used with Safety Modules.

Applicable Standards and Functions

◆ Applicable Safety Standards

Safety Standard	Applicable Standard	Applicable Products	
		SERVOPACK	SERVOPACK + Safety Module
Safety of Machinery	EN ISO13849-1: 2015 IEC 60204-1	✓	✓
Functional Safety	IEC 61508 Series IEC 62061 IEC 61800-5-2	✓	✓
EMC	IEC 61326-3-1	✓	✓

✓: Applicable

◆ Support for Functions Defined in IEC61800-5-2

Safety functions are implemented by using the hard wire base block (HWBB) in the SERVOPACK.

Safety Function	Description	Applicable Products	
		SERVOPACK	SERVOPACK + Safety Module
Safe BaseBlock Function (SBB function)	This safety function is equivalent to an STO function. (It shuts OFF the power supply from the SERVOPACK to the motor.)	✓	✓
Safe BaseBlock with Delay Function (SBB-D function)	This safety function is equivalent to an SS1 function. (It monitors the deceleration operation of the motor for the specified time and then shuts OFF the power supply from the SERVOPACK to the motor.)	–	✓
Safe Position Monitor with Delay Function (SPM-D function)	This safety function is equivalent to an SS2 function. (It monitors the deceleration operation of the motor for the specified time and then monitors the position after the motor stops.)	–	✓
Safely-Limit Speed with Delay Function (SLS-D function)	This safety function is equivalent to an SLS function. (It monitors the deceleration operation of the motor for the specified time and then monitors the speed of the motor to confirm that it remains in the allowable range.)	–	✓

✓: Applicable

Specifications

◆ Basic Specifications

Item		Specification	
Operating Conditions	Surrounding Air Temperature	0°C to +55°C	
	Storage Temperature	-20°C to +85°C	
	Surrounding Air Humidity	90% relative humidity max.	There must be no freezing or condensation.
	Storage Humidity	90% relative humidity max.	
	Vibration Resistance	4.9 m/s ²	
	Shock Resistance	19.6 m/s ²	
	Degree of Protection	IP10	<ul style="list-style-type: none"> • Must be no corrosive or flammable gases. • Must be no exposure to water, oil, or chemicals. • Must be no dust, salts, or iron dust.
	Pollution Degree	2	
	Altitude	1000 m max.	
	Others	Do not use the SERVOPACK in the following locations: Locations subject to static electricity noise, strong electromagnetic/magnetic fields, or radioactivity	

◆ Compliance with UL Standards, EU Directives, and Other Safety Standards (in Combination with SERVOPACK)

Item		Specification	
North American Safety Standards		UL61800-5-1 CSA C22.2 No.274	
European Directives	Machinery Directive (2006/42/EC)	EN ISO 13849-1: 2015	
	EMC Directive (2004/108/EC)	EN 55011/A2 group 1, class A EN 61000-6-2 EN 61000-6-4 EN 61800-3	
	Low Voltage Directive (2006/95/EC)	EN 50178 EN 61800-5-1	
Safety Standards	Safety of Machinery	EN ISO 13849-1: 2015 IEC 60204-1	
	Functional Safety	IEC 61508 series IEC 62061 IEC 61800-5-2	
	EMC	IEC 61326-3-1	
Safety Function		IEC 61800-5-2	IEC 60204-1
		Safe Torque Off (STO)	Stop Category 0
		Safe Stop 1 (SS1)	Stop Category 1
		Safe Stop 2 (SS2)	Stop Category 2
		Safely-Limited Speed (SLS)	
	Number of Blocks	2	
	Safety Function A	Input signals: 2 channels (redundant signals), output signals: 1 channel	
	Safety Function B	Input signals: 2 channels (redundant signals), output signals: 1 channel	
Safe Performance			
	Safety Integrity Level	SIL2, SILCL2	
	Probability of Dangerous Failure per Hour	PFH = 8.0×10 ⁻⁹ [1/h] (SBB) PFH = 3.4×10 ⁻⁸ [1/h] (SBB-D, SPM-D, SLS-D)	
	Performance Level	PLd (Category 2)	
	Mean Time to Dangerous Failure of Each Channel	MTTFd: High	
	Average Diagnostic Coverage	DCave: Medium	
	Proof Test Interval	10 years	

External Dimensions

Refer to pages 436 to 447 for the external dimensions of the individual SERVOPACKs.

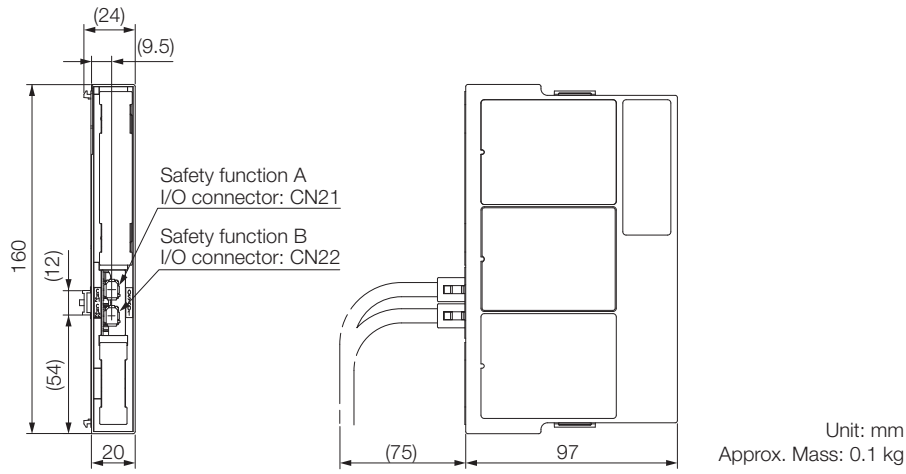

Connectors

Device Label	Model	Number of Pins	Manufacturer
CN21	1981080-1	8	Tyco Electronics Japan G.K.
CN22	1981080-1	8	Tyco Electronics Japan G.K.

Note: 1. The above connectors or their equivalents are used for SERVOPACKs.

2. Refer to the user's manual of the Safety Module for installation standards.

Cables for Safety Module

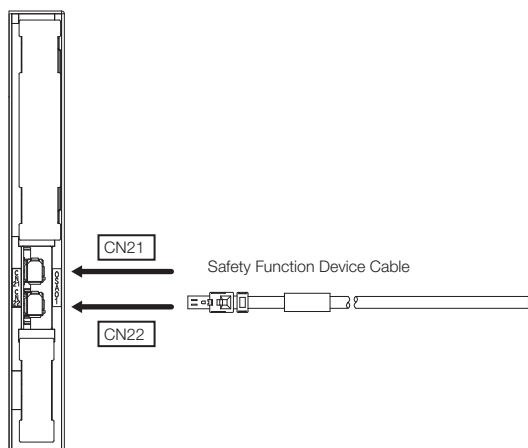

◆ Safety Function Device Cable

Order Number	Length (L)	Inquires
JZSP-CVH03-01-E	1 m	Yaskawa Controls Co., Ltd.
JZSP-CVH03-03-E	3 m	

- Note: 1. When using safety functions, connect this Cable to the safety function devices.
 When not using safety functions, connect the enclosed Safety Jumper Connector (JZSP-CVH05-E) to the SERVOPACK.
2. If you make your own cable, use the following Connector Kit. Contact Tyco Electronics Japan G.K. for details.

◆ Connector Kit

If you make your own cable, use the Connector Kit.

Order Number	Product Name	Inquires
2013595-1	INDUSTRIAL MINI I/O D-SHAPE TYPE1 PLUG CONNECTOR KIT	Tyco Electronics Japan G.K.

Appendices

Capacity Selection for Servomotors	492
Capacity Selection for Regenerative Resistors	500
International Standards	518
Warranty	520

Capacity Selection for Servomotors	
Capacity Selection for Regenerative Resistors	
International Standards	
Warranty	

Capacity Selection for Servomotors

Selecting the Servomotor Capacity

Use Yaskawa's SigmaSize+, an AC servo drive capacity selection program, to select the Servomotor capacity. With the SigmaSize+, you can find the optimum Servomotor capacity by simply selecting and entering information according to instructions from a wizard.

Refer to the following selection examples to select Servomotor capacities with manual calculations rather than with the above software.

Capacity Selection Example for a Rotary Servomotor: For Speed Control

1. Mechanical Specifications

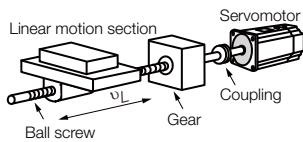

Item	Code	Value
Load Speed	v_L	15 m/min
Linear Motion Section Mass	m	250 kg
Ball Screw Length	ℓ_B	1.0 m
Ball Screw Diameter	d_B	0.02 m
Ball Screw Lead	P_B	0.01 m
Ball Screw Material Density	ρ	$7.87 \times 10^3 \text{ kg/m}^3$
Gear Ratio	R	2 (gear ratio: 1/2)
External Force on Linear Motion Section	F	0 N

Item	Code	Value
Gear and Coupling Moment of Inertia	J_G	$0.40 \times 10^{-4} \text{ kg}\cdot\text{m}^2$
Number of Feeding Operations	n	40 operations/min
Feeding Distance	ℓ	0.275 m
Feeding Time	tm	1.2 s max.
Friction Coefficient	μ	0.2
Mechanical Efficiency	η	0.9 (90%)

2. Operation Pattern

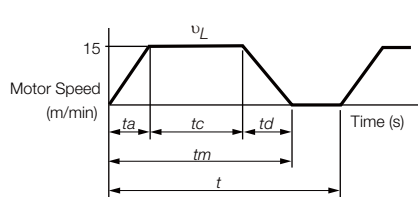

$$t = \frac{60}{n} = \frac{60}{40} = 1.5 \text{ (s)}$$

$$\text{If } t_a = t_d,$$

$$t_a = t_m - \frac{60 \ell}{v_L} = 1.2 - \frac{60 \times 0.275}{15} = 1.2 - 1.1 = 0.1 \text{ (s)}$$

$$t_c = 1.2 - 0.1 \times 2 = 1.0 \text{ (s)}$$

3. Motor Speed

- Load shaft speed $n_L = \frac{v_L}{P_B} = \frac{15}{0.01} = 1,500 \text{ (min}^{-1}\text{)}$

- Motor shaft speed $n_M = n_L \cdot R = 1,500 \times 2 = 3,000 \text{ (min}^{-1}\text{)}$

4. Load Torque

$$T_L = \frac{(9.8 \cdot \mu \cdot m + F) \cdot P_B}{2\pi R \cdot \eta} = \frac{(9.8 \times 0.2 \times 250 + 0) \times 0.01}{2\pi \times 2 \times 0.9} = 0.43 \text{ (N}\cdot\text{m)}$$

5. Load Moment of Inertia

- Linear motion section

$$J_{L1} = m \left(\frac{P_B}{2\pi R} \right)^2 = 250 \times \left(\frac{0.01}{2\pi \times 2} \right)^2 = 1.58 \times 10^{-4} \text{ (kg}\cdot\text{m}^2\text{)}$$

- Ball screw

$$J_B = \frac{\pi}{32} \rho \cdot l_B \cdot d_B^4 \cdot \frac{1}{R^2} = \frac{\pi}{32} \times 7.87 \times 10^3 \times 1.0 \times (0.02)^4 \cdot \frac{1}{2^2} = 0.31 \times 10^{-4} \text{ (kg}\cdot\text{m}^2\text{)}$$

- Coupling $J_G = 0.40 \times 10^{-4}$ (kg·m²)
- Load moment of inertia at motor shaft

$$J_L = J_{L1} + J_B + J_G = (1.58 + 0.31 + 0.40) \times 10^{-4} = 2.29 \times 10^{-4} \text{ (kg}\cdot\text{m}^2\text{)}$$

6. Load Moving Power

$$P_O = \frac{2\pi n_M \cdot T_L}{60} = \frac{2\pi \times 3,000 \times 0.43}{60} = 135 \text{ (W)}$$

7. Load Acceleration Power

$$P_a = \left(\frac{2\pi}{60} n_M \right)^2 \frac{J_L}{ta} = \left(\frac{2\pi}{60} \times 3,000 \right)^2 \times \frac{2.29 \times 10^{-4}}{0.1} = 226 \text{ (W)}$$

8. Servomotor Provisional Selection

① Selection Conditions

- $T_L \leq$ Motor rated torque
- $\frac{(P_O + P_a)}{2} <$ Provisionally selected Servomotor rated output $< (P_O + P_a)$
- $n_M \leq$ Rated motor speed
- $J_L \leq$ Allowable load moment of inertia

The following Servomotor meets the selection conditions.

- SGM7J-02A Servomotor

② Specifications of the Provisionally Selected Servomotor

Item	Value
Rated Output	200 (W)
Rated Motor Speed	3,000 (min ⁻¹)
Rated Torque	0.637 (N·m)
Instantaneous Maximum Torque	2.23 (N·m)
Motor Moment of Inertia	0.263×10^{-4} (kg·m ²)
Allowable Load Moment of Inertia	$0.263 \times 10^{-4} \times 15 = 3.94 \times 10^{-4}$ (kg·m ²)

9. Verification of the Provisionally Selected Servomotor

- Verification of required acceleration torque:

$$T_P = \frac{2\pi n_M (J_M + J_L)}{60ta} + T_L = \frac{2\pi \times 3,000 \times (0.263 + 2.29) \times 10^{-4}}{60 \times 0.1} + 0.43$$

$$\approx 1.23 \text{ (N}\cdot\text{m)} < \text{Maximum instantaneous torque...Satisfactory}$$

- Verification of required deceleration torque:

$$T_S = \frac{2\pi n_M (J_M + J_L)}{60td} - T_L = \frac{2\pi \times 3,000 \times (0.263 + 2.29) \times 10^{-4}}{60 \times 0.1} - 0.43$$

$$\approx 0.37 \text{ (N}\cdot\text{m)} < \text{Maximum instantaneous torque...Satisfactory}$$

- Verification of effective torque value:

$$T_{rms} = \sqrt{\frac{T_P^2 \cdot ta + T_L^2 \cdot tc + Ts^2 \cdot td}{t}} = \sqrt{\frac{(1.23)^2 \times 0.1 + (0.43)^2 \times 1.0 + (0.37)^2 \times 0.1}{1.5}}$$

$$\approx 0.483 \text{ (N}\cdot\text{m)} < \text{Rated torque...Satisfactory}$$

10. Result

It has been verified that the provisionally selected Servomotor is applicable. The torque diagram is shown below.

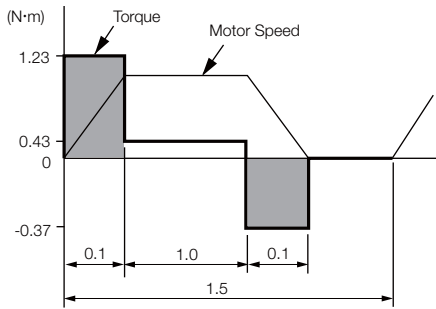

Capacity Selection Example for a Rotary Servomotor: For Position Control

1. Mechanical Specifications

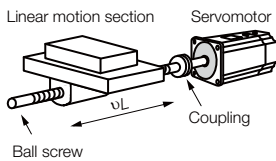

Item	Code	Value
Load Speed	v_L	15 m/min
Linear Motion Section Mass	m	80 kg
Ball Screw Length	ℓ_B	0.8 m
Ball Screw Diameter	d_B	0.016 m
Ball Screw Lead	P_B	0.005 m
Ball Screw Material Density	ρ	$7.87 \times 10^3 \text{ kg/m}^3$
External Force on Linear Motion Section	F	0 N
Coupling Mass	m_C	0.3 kg

Item	Code	Value
Coupling Outer Diameter	d_C	0.03 m
Number of Feeding Operations	n	40 rotation/min
Feeding Distance	ℓ	0.25 m
Feeding Time	tm	1.2 s max.
Electrical Stopping Precision	δ	$\pm 0.01 \text{ mm}$
Friction Coefficient	μ	0.2
Mechanical Efficiency	η	0.9 (90%)

2. Speed Diagram

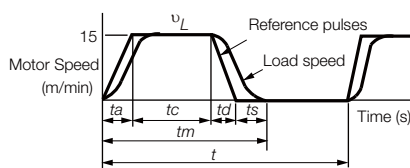

$$t = \frac{60}{n} = \frac{60}{40} = 1.5 \text{ (s)}$$

If $ta = td$ and $ts = 0.1 \text{ (s)}$,

$$ta = tm - ts - \frac{60 \ell}{v_L} = 1.2 - 0.1 - \frac{60 \times 0.25}{15} = 0.1 \text{ (s)}$$

$$tc = 1.2 - 0.1 - 0.1 \times 2 = 0.9 \text{ (s)}$$

3. Motor Speed

- Load shaft speed

$$n_L = \frac{v_L}{P_B} = \frac{15}{0.005} = 3,000 \text{ (min}^{-1}\text{)}$$

- Motor shaft speed

Direct coupling gear ratio 1/R = 1/1

Therefore, $n_M = n_L \cdot R = 3,000 \times 1 = 3,000 \text{ (min}^{-1}\text{)}$

4. Load Torque

$$T_L = \frac{(9.8 \mu \cdot m + F) \cdot P_B}{2\pi R \cdot \eta} = \frac{(9.8 \times 0.2 \times 80 + 0) \times 0.005}{2\pi \times 1 \times 0.9} = 0.139 \text{ (N}\cdot\text{m)}$$

5. Load Moment of Inertia

- Linear motion section

$$J_{L1} = m \left(\frac{P_B}{2\pi R} \right)^2 = 80 \times \left(\frac{0.005}{2\pi \times 1} \right)^2 = 0.507 \times 10^{-4} \text{ (kg}\cdot\text{m}^2\text{)}$$

- Ball screw $J_B = \frac{\pi}{32} \rho \cdot l_B \cdot d_B^4 = \frac{\pi}{32} \times 7.87 \times 10^3 \times 0.8 \times (0.016)^4 = 0.405 \times 10^{-4} \text{ (kg}\cdot\text{m}^2\text{)}$

- Coupling $J_C = \frac{1}{8} m_C \cdot d_C^2 = \frac{1}{8} \times 0.3 \times (0.03)^2 = 0.338 \times 10^{-4} \text{ (kg}\cdot\text{m}^2\text{)}$

- Load moment of inertia at motor shaft

$$J_L = J_{L1} + J_B + J_C = 1.25 \times 10^{-4} \text{ (kg}\cdot\text{m}^2\text{)}$$

6. Load Moving Power

$$P_O = \frac{2\pi n_M \cdot T_L}{60} = \frac{2\pi \times 3,000 \times 0.139}{60} = 43.7 \text{ (W)}$$

7. Load Acceleration Power

$$P_a = \left(\frac{2\pi}{60} n_M \right)^2 \frac{J_L}{t_a} = \left(\frac{2\pi}{60} \times 3,000 \right)^2 \times \frac{1.25 \times 10^{-4}}{0.1} = 123.4 \text{ (W)}$$

8. Servomotor Provisional Selection

① Selection Conditions

- $T_L \leq$ Motor rated torque
- $\frac{(P_o + P_a)}{2} <$ Provisionally selected Servomotor rated output $< (P_o + P_a)$
- $n_M \leq$ Rated motor speed
- $J_L \leq$ Allowable load moment of inertia

The following Servomotor meets the selection conditions.

- SGM7J-01A Servomotor

② Specifications of the Provisionally Selected Servomotor

Item	Value
Rated Output	100 (W)
Rated Motor Speed	3,000 (min ⁻¹)
Rated Torque	0.318 (N·m)
Instantaneous Maximum Torque	1.11 (N·m)
Motor Moment of Inertia	0.0659 × 10 ⁻⁴ (kg·m ²)
Allowable Load Moment of Inertia	0.0659 × 10 ⁻⁴ × 35 = 2.31 × 10 ⁻⁴ (kg·m ²)
Encoder Resolution	16,777,216 pulses/rev [24 bits]

9. Verification of the Provisionally Selected Servomotor

- Verification of required acceleration torque:

$$T_P = \frac{2\pi n_M (J_M + J_L)}{60ta} + T_L = \frac{2\pi \times 3,000 \times (0.0659 + 1.25) \times 10^{-4}}{60 \times 0.1} + 0.139$$

$$\approx 0.552 \text{ (N}\cdot\text{m)} < \text{Maximum instantaneous torque...Satisfactory}$$

- Verification of required deceleration torque:

$$T_S = \frac{2\pi n_M (J_M + J_L)}{60td} - T_L = \frac{2\pi \times 3,000 \times (0.0659 + 1.25) \times 10^{-4}}{60 \times 0.1} - 0.139$$

$$\approx 0.274 \text{ (N}\cdot\text{m)} < \text{Maximum instantaneous torque...Satisfactory}$$

- Verification of effective torque value:

$$T_{rms} = \sqrt{\frac{T_P^2 \cdot ta + T_L^2 \cdot tc + T_S^2 \cdot td}{t}} = \sqrt{\frac{(0.552)^2 \times 0.1 + (0.139)^2 \times 0.9 + (0.274)^2 \times 0.1}{1.5}}$$

$$\approx 0.192 \text{ (N}\cdot\text{m)} < \text{Rated torque...Satisfactory}$$

It has been verified that the provisionally selected Servomotor is applicable in terms of capacity. Position control is considered next.

10. Positioning Resolution

The electrical stopping precision δ is ± 0.01 mm, so the positioning resolution $\Delta \ell$ is 0.01 mm. The ball screw lead P_B is 0.005 m, so the number of pulses per motor rotation is calculated with the following formula.

$$\text{The number of pulses per revolution (pulses)} = \frac{P_B}{\Delta \ell} = \frac{5 \text{ mm/rev}}{0.01 \text{ mm}} = 500 \text{ (pulses/rev)} < \text{Encoder resolution [16777216 (pulses/rev)]}$$

The number of pulses per motor rotation is less than the encoder resolution (pulses/rev), so the provisionally selected Servomotor can be used.

11. Reference Pulse Frequency

The load speed v_L is 15 m/min, or $1,000 \times 15/60$ mm/s and the positioning resolution (travel distance per pulse) is 0.01 mm/pulse, so the reference pulse frequency is calculated with the following formula.

$$v_s = \frac{1,000 v_L}{60 \times \Delta \ell} = \frac{1,000 \times 15}{60 \times 0.01} = 25,000 \text{ (pps)}$$

The reference pulse frequency is less than the maximum input pulse frequency,* so the provisionally selected Servomotor can be used.

*Refer to the specifications in the SERVOPACK manual for the maximum input pulse frequency.

It has been verified that the provisionally selected Servomotor is applicable for position control.

Capacity Selection Example for Direct Drive Servomotors

1. Mechanical Specifications

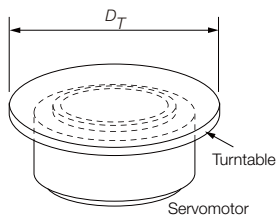

Item	Code	Value	Item	Code	Value
Turntable Mass	w	12 kg	Acceleration/Deceleration Time	$t_p = t_{psa} = t_{psd}$	0.1 s
Turntable Diameter	D_T	300 mm	Operating Frequency	t_f	2 s
Rotational Angle per Cycle	θ	270 deg	Load Torque	T_L	0 N·m
Positioning Time	t_0	0.35 s	Settling Time	t_s	0.1 s

2. Motor Speed of Direct Drive Servomotor

$$N_O = \frac{\theta}{360} \times \frac{60}{(t_0 - t_p - t_s)} = \frac{270}{360} \times \frac{60}{(0.35 - 0.1 - 0.1)} = 300 \text{ (min}^{-1}\text{)}$$

3. Operation Pattern

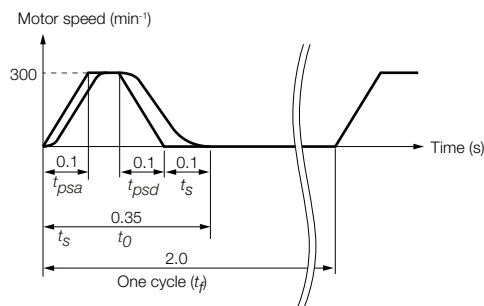

4. Load Moment of Inertia

$$J_L = \frac{1}{8} \times D_T^2 \times W = \frac{1}{8} \times (300 \times 10^{-3})^2 \times 12 = 0.135 \text{ (kg} \cdot \text{m}^2\text{)}$$

5. Load Acceleration/Deceleration Torque

$$T_a = J_L \times 2\pi \times \frac{N_O/60}{t_p} = 0.135 \times 2\pi \times \frac{300/60}{0.1} = 42.4 \text{ (N} \cdot \text{m)}$$

6. Provisional Selection of Direct Drive Servomotor

① Selection Conditions

- Load acceleration/deceleration torque < Instantaneous maximum torque of Direct Drive Servomotor
- Load moment of inertia < Allowable load moment of inertia ratio (J_R) × Moment of inertia of Direct Drive Servomotor (J_M)

The following Servomotor meets the selection conditions.

- SGMCV-17CEA11

② Specifications of the Provisionally Selected Servomotor

Item	Value
Rated Torque	17 (N·m)
Instantaneous Maximum Torque	51 (N·m)
Moment of Inertia (J_M)	0.00785 (kg·m ²)
Allowable Load Moment of Inertia Ratio (J_R)	25

7. Verification of the Provisionally Selected Servomotor

- Verification of required acceleration torque:

$$T_{Ma} = \frac{(J_L + J_M) \times N_O}{9.55 \times t_{psa}} = \frac{(0.135 + 0.00785) \times 300}{9.55 \times 0.1}$$

$$\approx 44.9 \text{ (N}\cdot\text{m)} < \text{Maximum instantaneous torque...Satisfactory}$$

- Verification of required deceleration torque:

$$T_{Md} = -\frac{(J_L + J_M) \times N_O}{9.55 \times t_{psd}} = -\frac{(0.135 + 0.00785) \times 300}{9.55 \times 0.1}$$

$$\approx -44.9 \text{ (N}\cdot\text{m)} < \text{Maximum instantaneous torque...Satisfactory}$$

- Verification of effective torque value:

$$T_{rms} = \sqrt{\frac{T_{Ma}^2 \times t_{psa} + T_L^2 \times t_c + T_{Md}^2 \times t_{psd}}{t}} = \sqrt{\frac{44.9^2 \times 0.1 + 0^2 \times 0.05 + (-44.9)^2 \times 0.1}{2}}$$

$$\approx 14.2 \text{ (N}\cdot\text{m)} < \text{Rated torque...Satisfactory}$$

$$t_c = \text{Time of constant motor speed} = t_0 - t_s - t_{psa} - t_{psd}$$

8. Result

It has been verified that the provisionally selected Servomotor is applicable. The torque diagram is shown below.

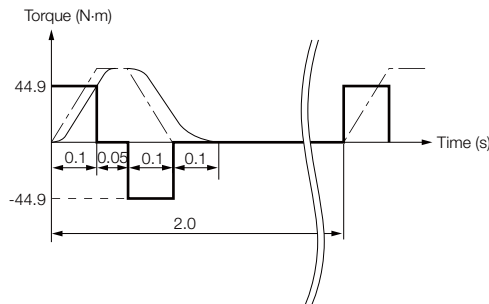

Servomotor Capacity Selection Example for Linear Servomotors

1. Mechanical Specifications

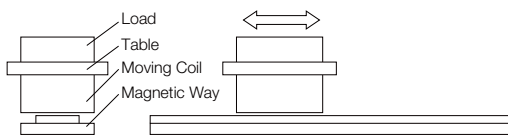

Item	Code	Value
Load Mass	m_W	1 kg
Table Mass	m_T	2 kg
Motor Speed	v	2 m/s
Feeding Distance	l	0.76 m
Friction Coefficient	μ	0.2

Item	Code	Value
Acceleration Time	t_a	0.02 s
Constant-speed Time	t_c	0.36 s
Deceleration Time	t_d	0.02 s
Cycle Time	t	0.5 s
External Force on Linear Motion Section	F	0 N

2. Operation Pattern

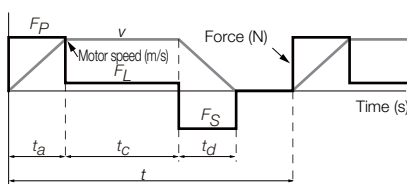

3. Steady-State Force (Excluding Servomotor Moving Coil)

$$F_L = \{9.8 \times \mu \times (m_W + m_T)\} + F = 9.8 \times 0.2 \times (1 + 2) + 0 = 5.88 \text{ (N)}$$

4. Acceleration Force (Excluding Servomotor Moving Coil)

$$F_P = (m_W + m_T) \times \frac{v}{t_a} + F_L = (1 + 2) \times \frac{2}{0.02} + 5.88 = 305.88 \text{ (N)}$$

5. Provisional Selection of Linear Servomotor

① Selection Conditions

- $F_P \leq \text{Maximum force} \times 0.9$
- $F_S \leq \text{Maximum force} \times 0.9$
- $F_{rms} \leq \text{Rated force} \times 0.9$

The following Servomotor Moving Coil and Magnetic Way meet the selection conditions.

- SGLGW-60A253CP Linear Servomotor Moving Coil
- SGLGM-60□□□C Linear Servomotor Magnetic Way

② Specifications of the Provisionally Selected Servomotor

Item	Value
Maximum Force	440 (N)
Rated Force	140 (N)
Moving Coil Mass (m_M)	0.82 (kg)
Servomotor Magnetic Attraction (F_{att})	0 (N)

6. Verification of the Provisionally Selected Servomotor

- Steady-State Force

$$F_L = \mu \{9.8 \times (m_W + m_T + m_M) + F_{att}\} = 0.2 \{9.8 \times (1 + 2 + 0.82) + 0\} = 7.5 \text{ (N)}$$

- Verification of Acceleration Force

$$F_P = (m_W + m_T + m_M) \times \frac{v}{t_a} + F_L = (1 + 2 + 0.82) \times \frac{2}{0.02} + 7.5$$

$$= 389.5 \text{ (N)} \leq \text{Maximum force} \times 0.9 (= 396 \text{ N}) \dots \text{Satisfactory}$$

- Verification of Deceleration Force

$$F_S = (m_W + m_T + m_M) \times \frac{v}{t_a} - F_L = (1 + 2 + 0.82) \times \frac{2}{0.02} - 7.5$$

$$= 374.5 \text{ (N)} \leq \text{Maximum force} \times 0.9 (= 396 \text{ N}) \dots \text{Satisfactory}$$

- Verification of Effective Force

$$F_{rms} = \sqrt{\frac{F_P^2 \cdot t_a + F_L^2 \cdot t_c + F_S^2 \cdot t_d}{t}} = \sqrt{\frac{389.5^2 \times 0.02 + 7.5^2 \times 0.36 + 374.5^2 \times 0.02}{0.5}}$$

$$= 108.3 \text{ (N)} \leq \text{Rated force} \times 0.9 (= 132.3 \text{ N}) \dots \text{Satisfactory}$$

7. Result

It has been verified that the provisionally selected Servomotor is applicable.

Capacity Selection for Regenerative Resistors

If the regenerative power exceeds the amount that can be absorbed by charging the smoothing capacitor, a regenerative resistor is used.

Regenerative Power and Regenerative Resistance

The rotational energy of a driven machine such as a Servomotor that is returned to the SERVOPACK is called regenerative power. The regenerative power is absorbed by charging a smoothing capacitor. When the regenerative power exceeds the capacity of the capacitor, it is consumed by a regenerative resistor. (This is called resistance regeneration.)

The Servomotor is driven in a regeneration state in the following circumstances:

- While decelerating to a stop during acceleration/deceleration operation.
- While performing continuous downward operation on a vertical axis.
- During continuous operation in which the Servomotor is rotated by the load (i.e., a negative load).



You cannot use the resistance regeneration provided by the SERVOPACK for continuous regeneration. For continuous operation with a negative load, you must design a system that also includes a Power Regenerative Converter or Power Regenerative Unit (for example, Yaskawa model D1000 or R1000). If regenerative power is not appropriately processed, the regenerative energy from the load will exceed the allowable range and damage the SERVOPACK. Examples of negative loads are shown below.

- Motor Drive to Lower Objects without a Counterweight
- Motor Drive for Feeding

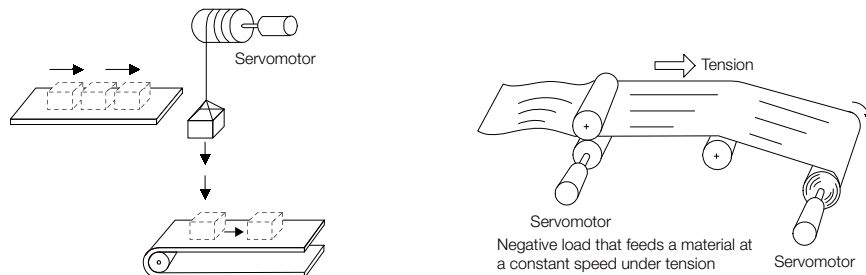

Types of Regenerative Resistors

The following regenerative resistors can be used.

- Built-in regenerative resistor: A regenerative resistor that is built into the SERVOPACK. Not all SERVOPACKs have built-in regenerative resistors.
- External Regenerative Resistor: A regenerative resistor that is connected externally to a SERVOPACK. These resistors are used when the smoothing capacitor and built-in regenerative resistor in the SERVOPACK cannot consume all of the regenerative power.

SERVOPACK Model	Built-In Regenerative Resistor	External Regenerative Resistor
SGD7S-	R70A, R90A, 1R6A, 2R8A, R70F, R90F, 2R1F, 2R8F	None
	3R8A, 5R5A, 7R6A, 120A, 180A, 200A, 330A	Standard feature *1
	470A, 550A, 590A, 780A	None
SGD7W-	1R6A, 2R8A, 5R5A, 7R6A	Standard feature *1
SGD7C-	1R6A, 2R8A, 5R5A, 7R6A	Standard feature *1

*1. Refer to the following section for the specifications of the regenerative resistors built into SERVOPACKs.

Built-In Regenerative Resistor (page 472)

*2. An optional external Regenerative Resistor Unit is required.

Selecting External Regenerative Resistor

Use Yaskawa's SigmaSize+, an AC servo drive capacity selection program, to determine if you need an External Regenerative Resistor.

You can use one of the following two methods to manually calculate whether an External Regenerative Resistor is required. Refer to the following information if you do not use the SigmaSize+.

 [Simple Calculation \(page 501\)](#)

 [Calculating the Regenerative Energy \(page 506\)](#)

Simple Calculation

When driving a Servomotor with a horizontal shaft, check if an External Regenerative Resistor is required using the following calculation method.

Note: If you use the SGD7S-470A, -550A, -590A, or -780A, always connect an External Regenerative Resistor.

◆ SERVOPACKs without Built-in Regenerative Resistors:

SGD7S-R70A, -R90A, -1R6A, -2R8A, -R70F, -R90F, -2R1F, and -2R8F

The total amount of energy that can be charged in the capacitors is given in the following table. If the rotational energy (E_S) of the Servomotor and load exceeds the value in the following table, then connect an External Regenerative Resistor.

Applicable SERVOPACK		Processable Regenerative Energy (Joules)	Remarks
SGD7S-	R70A, R90A, 1R6A	24.2	Value when main circuit input voltage is 200 VAC
	2R8A	31.7	
	R70F, R90F, 2R1F	28.6	Value when main circuit input voltage is 100 VAC
	2R8F	48.4	

Calculate the rotational energy (E_S) of the servo system with the following equation:

$$E_S = J \times (n_M)^2 / 182 \text{ (Joules)}$$

- $J = J_M + J_L$
- J_M : Servomotor moment of inertia ($\text{kg}\cdot\text{m}^2$)
- J_L : Load moment of inertia at motor shaft ($\text{kg}\cdot\text{m}^2$)
- n_M : Servomotor operating motor speed (min^{-1})

- ◆ **SERVOPACKs with Built-in Regenerative Resistors:**
 SGD7S-3R8A, -5R5A, -7R6A, -120A, -180A, -200A, and -330A
 SGD7W-1R6A, -2R8A, -5R5A, and -7R6A
 SGD7C-1R6A, -2R8A, -5R5A, and -7R6A

Use the following equation to calculate the allowable frequency for regenerative operation. The following operating conditions were used: Operation cycle from a speed of 0 to the maximum motor speed to 0 (min^{-1}) with acceleration and deceleration operation. If the frequency of the operation cycle ($1/T$) is lower than the allowable frequency in the calculation results, an External Regenerative Resistor is not necessary. Finally, do the calculation with the actual operating speed and load moment of inertia to determine if an External Regenerative Resistor is required.

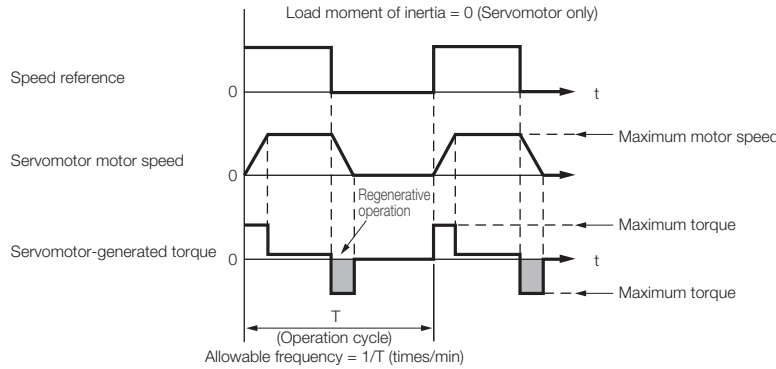

• **Operating Conditions for Calculating the Allowable Regenerative Frequency**

$$\text{Allowable frequency} = \frac{\text{Allowable frequency for regenerative operation for Servomotor without load}^*}{(1+n)} \times \left(\frac{\text{Maximum motor speed}}{\text{Operating motor speed}} \right)^2 \text{ (time/min)}$$

- $n = J_L/J_M$
- J_M : Servomotor moment of inertia ($\text{kg}\cdot\text{m}^2$)
- J_L : Load moment of inertia at motor shaft ($\text{kg}\cdot\text{m}^2$)

* Assign the related value given in the table in *Allowable Frequency for Regenerative Operation for Servomotor without Load* (pages 503 to 505).

■ Allowable Frequency for Regenerative Operation for Servomotor without Load

- Rotary Servomotors

Servomotor Model		Allowable Frequencies in Regenerative Operation (Operations/Min)		Servomotor Model		Allowable Frequencies in Regenerative Operation (Operations/Min)	
		SERVOPACK Model: SGD7S	SERVOPACK Model: SGD7W and SGD7C (Simultaneous Operation of Two Axes)			SERVOPACK Model: SGD7S	SERVOPACK Model: SGD7W and SGD7C (Simultaneous Operation of Two Axes)
SGMMV-	A1A	-	-	SGM7P-	01A	-	200
	A2A	-	-		C2A	-	46
	A3A	-	-		04A	-	29
SGM7J-	A5A	-	300		08A	11	11
	01A	-	180		15A	7.5	-
	C2A	-	130	SGM7G-	03A	39	39
	02A	-	46		05A	29	29
	04A	-	25		09A	6.9	6.9
	06A	30	30		13A	6.1	-
	08A	15	15		20A	7.4	-
SGM7A-	A5A	-	560		30A	9.5	-
	01A	-	360		44A	6.4	-
	C2A	-	260		55A	24	-
	02A	-	87		75A	34	-
	04A	-	56		1AA	39	-
	06A	77	77	1EA	31	-	
	08A	31	31				
	10A	31	-				
	15A	15	-				
	20A	19	-				
	25A	15	-				
	30A	6.9	-				
	40A	11	-				
	50A	8.8	-				
	70A	86	-				

Appendices

Capacity Selection for Regenerative Resistors

• Direct Drive Servomotors

Servomotor Model		Allowable Frequencies in Regenerative Operation (Operations/Min)		Servomotor Model		Allowable Frequencies in Regenerative Operation (Operations/Min)		
		SERVOPACK Model: SGD7S	SERVOPACK Model: SGD7W and SGD7C (Simultaneous Operation of Two Axes)			SERVOPACK Model: SGD7S	SERVOPACK Model: SGD7W and SGD7C (Simultaneous Operation of Two Axes)	
SGM7D-	01G	–	–	SGM7F-	02A	–	150	
	1AF	120	–		05A	–	83	
	1CI	74	–		07A	–	62	
	1ZI	91	–		04B	–	75	
	02K	–	–		08C	–	21	
	03H	–	–		10B	–	48	
	05G	–	–		14B	65	65	
	06J	350	–		16D	13	13	
	06L	–	–		17C	30	30	
	06K	–	–		25C	31	31	
	08G	430	–		35D	19	19	
	08K	–	–		45M	25	25	
	09J	250	–		80M	19	–	
	12L	–	–		1AM	8.9	–	
	18G	350	–		80N	22	–	
	18J	210	–		1EN	11	–	
	20J	200	–		2ZN	9.1	–	
	24G	270	–		SGMCMV-	04B	–	75
	28I	52	–			08C	–	21
	2BI	89	–			10B	–	48
	2DI	110	–			14B	65	65
	30F	210	–			16D	13	13
	30L	63	–			17C	30	30
	38J	150	–			25C	31	31
34G	220	–	35D	19	19			
45G	190	–	SGMCS-	02B	–	62		
58F	170	–		05B	–	34		
70I	100	–		07B	–	22		
90F	140	–		04C	–	22		
SGM7E-	02B	–		62	08D	–	6.1	
	05B	–		34	10C	–	19	
	07B	–		22	14C	–	22	
	04C	–		22	17D	–	7	
	08D	–		6.1	25D	–	9.3	
	10C	–		19	16E	3.7	3.7	
	14C	–		22	35E	9.7	9.7	
	17D	–		7	45M	25	25	
	25D	–		9.3	80M	19	–	
	16E	3.7		3.7	80N	8.9	–	
35E	9.7	9.7	1AM	22	–			
			1EN	11	–			
			2ZN	9.1	–			

• Linear Servomotors

Servomotor Model		Allowable Frequencies in Regenerative Operation (Operations/Min)	
		SERVOPACK Model: SGD7S	SERVOPACK Model: SGD7W and SGD7C (Simultaneous Operation of Two Axes)
SGLGW- Using a Standard-Force Magnetic Way	30A050C	–	190
	30A080C	–	120
	40A140C	–	56
	40A253C	–	32
	40A365C	–	22
	60A140C	–	49
	60A253C	–	27
	60A365C	37	37
	90A200C	34	–
	90A370C	33	–
90A535C	24	–	
SGLGW- Using a High-Force Magnetic Way	40A140C	–	80
	40A253C	–	45
	40A365C	62	62
	60A140C	–	64
	60A253C	71	71
	60A365C	49	49
SGLFW-	20A090A	–	27
	20A120A	–	21
	35A120A	–	14
	35A230A	16	16
	50A200B	10	10
	50A380B	6.9	–
	1ZA200B	7.8	–
	1ZA380B	6.6	–

Servomotor Model		Allowable Frequencies in Regenerative Operation (Operations/Min)	
		SERVOPACK Model: SGD7S	SERVOPACK Model: SGD7W and SGD7C (Simultaneous Operation of Two Axes)
SGLFW2-	30A070A	–	38
	30A120A	–	21
	30A230A	22	11
	45A200A	16	16
	45A380A	10*1	–
		17*2	–
	90A200A	14	–
	90A380A	11	–
	90A560A	18	–
	1DA380A	21	–
	1DA560A	32	–
	SGLTW-	20A170A	15
20A320A		8.3	8.3
20A460A		7.1	–
35A170A		10	10
35A170H		8.5	8.5
35A320A		7	–
35A320H		5.9	–
35A460A		7.6	–
40A400B		13	–
40A600B		19	–
50A170H		15	15
50A320H		11	–
80A400B	28	–	
80A600B	180	–	

*1. This value is in combination with the SGD7S-120A.

*2. This value is in combination with the SGD7S-180A.

Calculating the Regenerative Energy

This section shows how to calculate the regenerative resistor capacity for the acceleration/deceleration operation shown in the following figure.

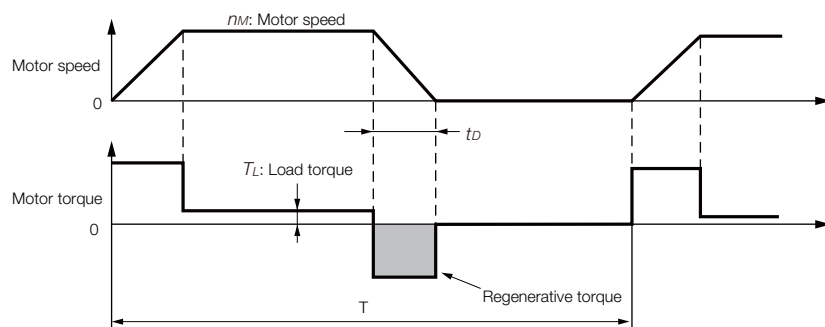

• Calculation Procedure for Regenerative Resistor Capacity

Step	Item	Code	Formula
1	Calculate the rotational energy of the Servomotor.	E_S	$E_S = Jn_M^2/182$
2	Calculate the energy consumed by load loss during the deceleration period	E_L	$E_L = (\pi/60) n_M T_L t_D$ Note: If the load loss is unknown, calculate the value with E_L set to 0.
3	Calculate the energy lost from Servomotor winding resistance.	E_M	(Value calculated from the graphs in ◆ Servomotor Winding Resistance Loss on page 508) $\times t_D$
4	Calculate the energy that can be absorbed by the SERVOPACK.	E_C	Calculate from the graphs in ◆ SERVOPACK-absorbable Energy on page 507
5	Calculate the energy consumed by the regenerative resistor.	E_K	$E_K = E_S - (E_L + E_M + E_C)$
6	Calculate the required regenerative resistor capacity (W).	W_K	$W_K = E_K/(0.2 \times T)$

Note: 1. The 0.2 in the equation for calculating W_K is the value when the regenerative resistor's utilized load ratio is 20%.

2. The units for the various symbols are given in the following table.

Code	Description	Code	Description
E_S to E_K	Energy in joules (J)	T_L	Load torque (N·m)
W_K	Required regenerative resistor capacity (W)	t_D	Deceleration stopping time (s)
J	$= J_M + J_L$ (kg·m ²)	T	Servomotor repeat operation cycle (s)
n_M	Servomotor motor speed (min ⁻¹)		

If the value of W_K does not exceed the capacity of the built-in regenerative resistor of the SERVOPACK, an External Regenerative Resistor is not required. If the value of W_K exceeds the capacity of the built-in regenerative resistor, install an External Regenerative Resistor with a capacity equal to the value for W calculated above.

◆ SERVOPACK-absorbable Energy

The following figures show the relationship between the SERVOPACK's input power supply voltage and its absorbable energy.

■ Σ-7S SERVOPACKs

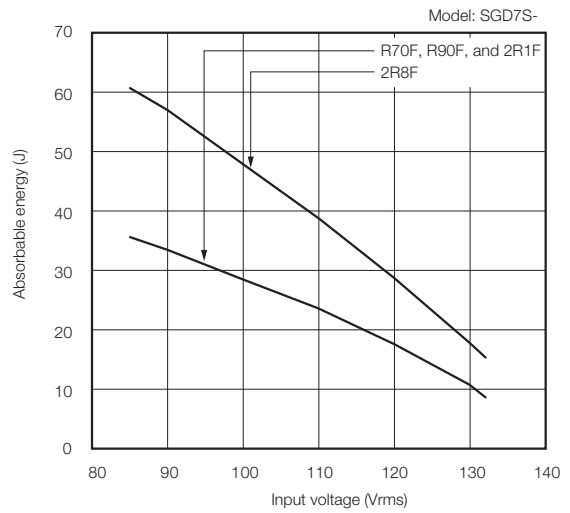
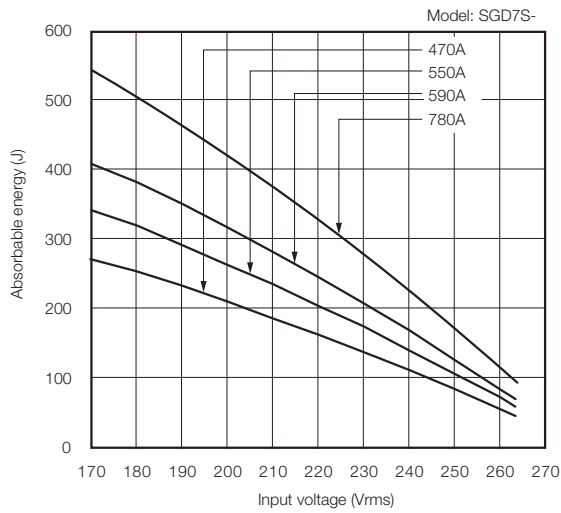
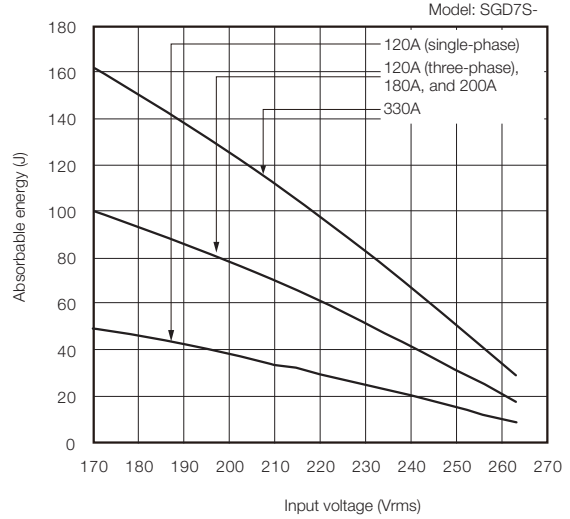
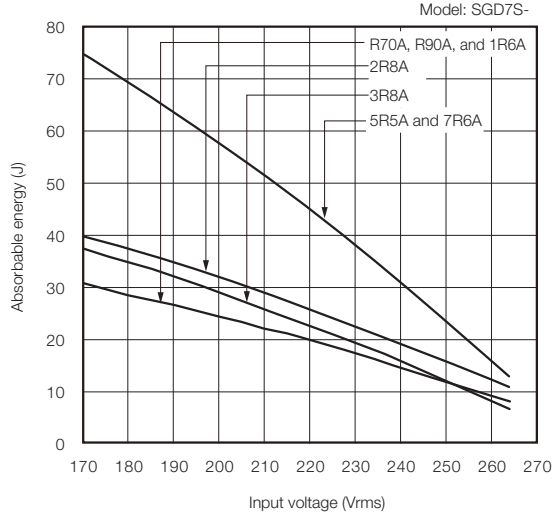

■ Σ-7W SERVOPACKs

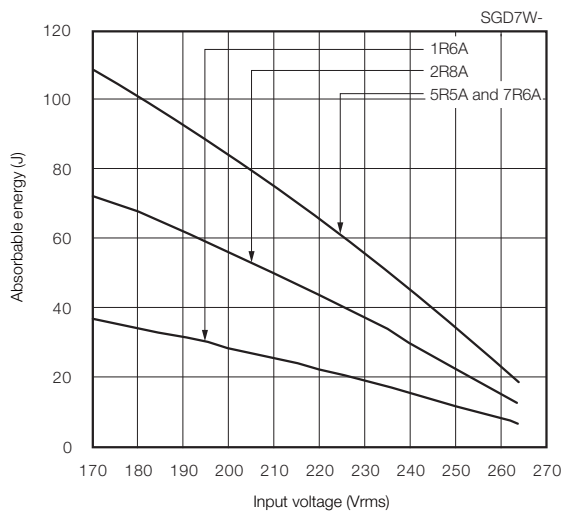

■ Σ-7C SERVOPACKs

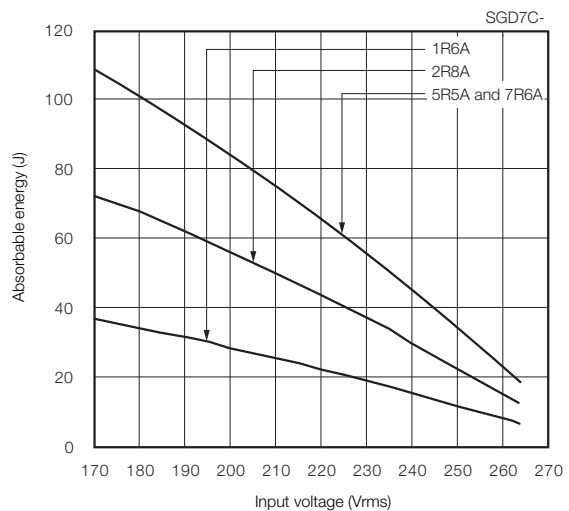

◆ Servomotor Winding Resistance Loss

The following figures show the relationship for each Servomotor between the Servomotor's generated torque and the winding resistance loss.

■ SGMMV Rotary Servomotors

Contact your Yaskawa representative for information on the SGMMV Rotary Servomotors.

■ SGM7J Rotary Servomotors

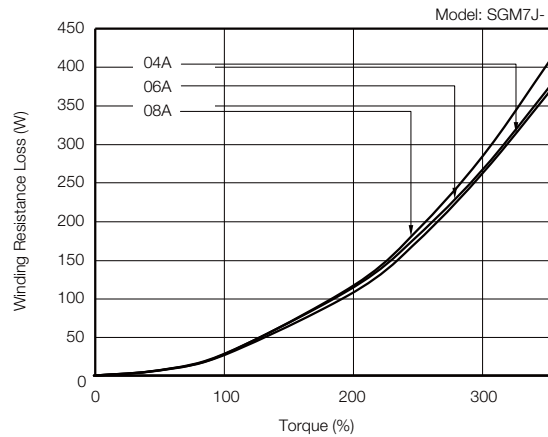
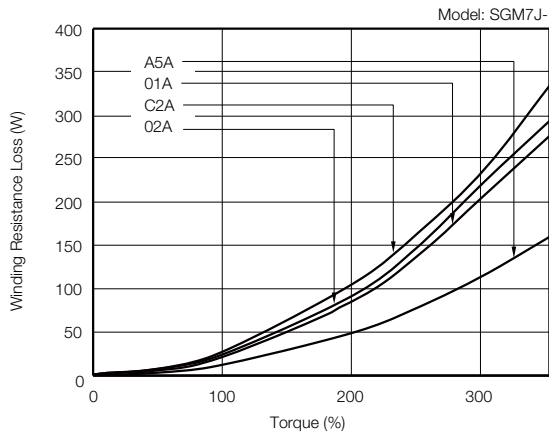

■ SGM7A Rotary Servomotors

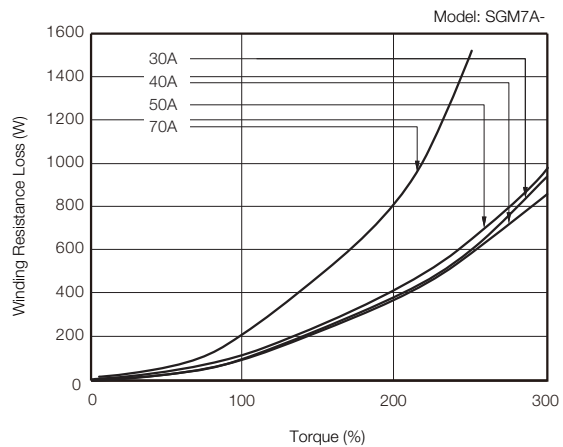
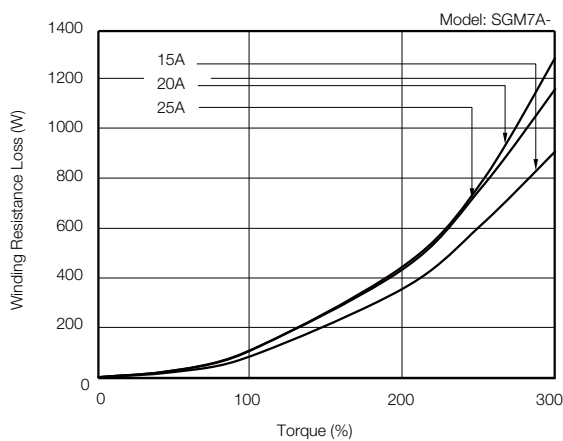
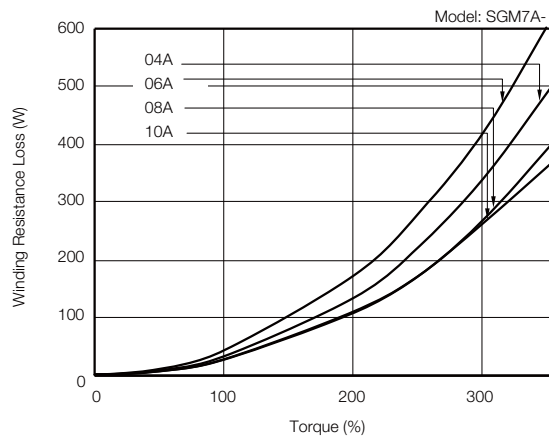
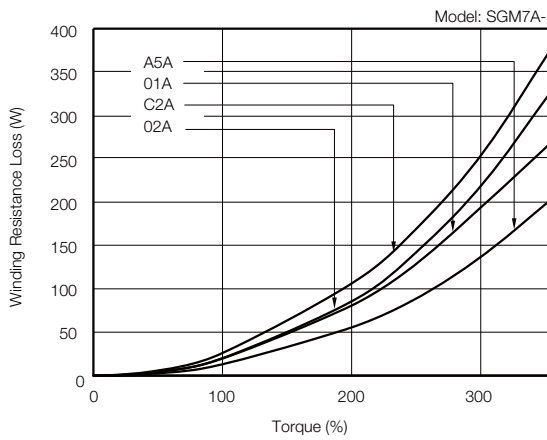

■ SGM7P Rotary Servomotors

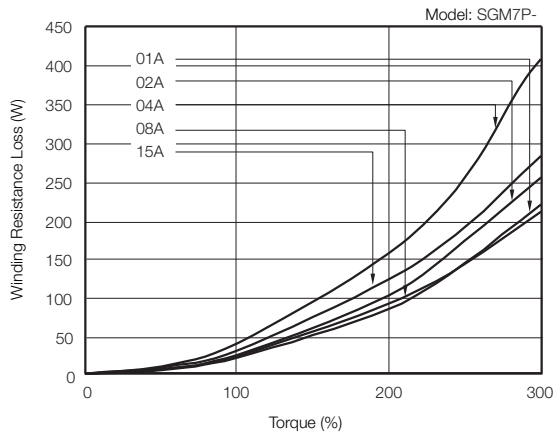

■ SGM7G Rotary Servomotors

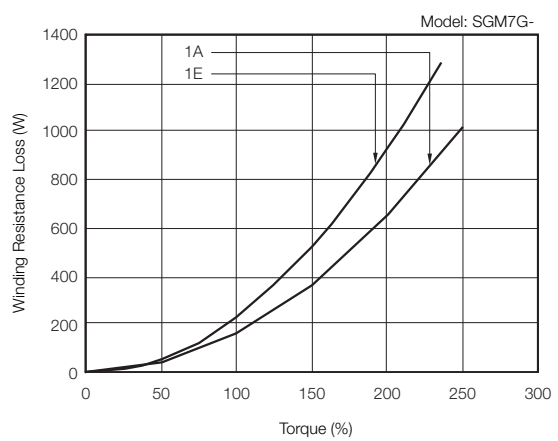
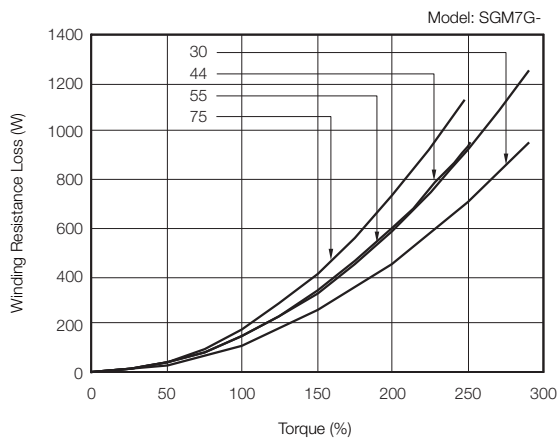
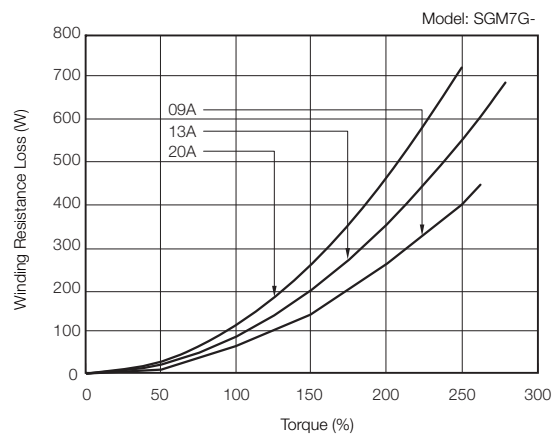
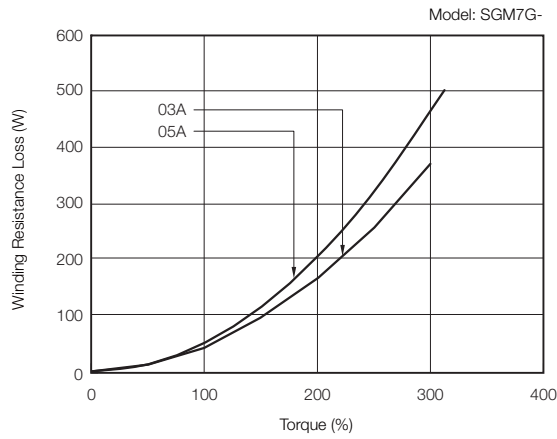

■ SGM7D Direct Drive Servomotors

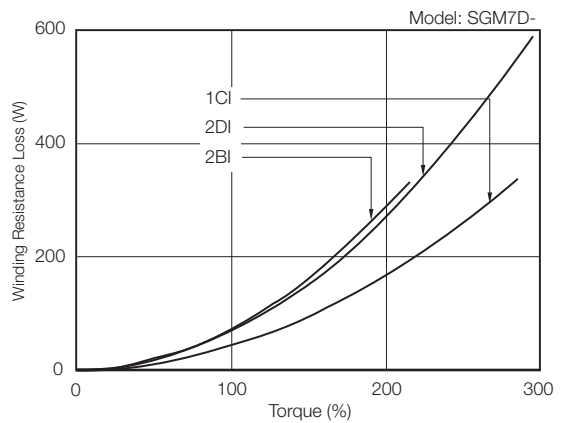
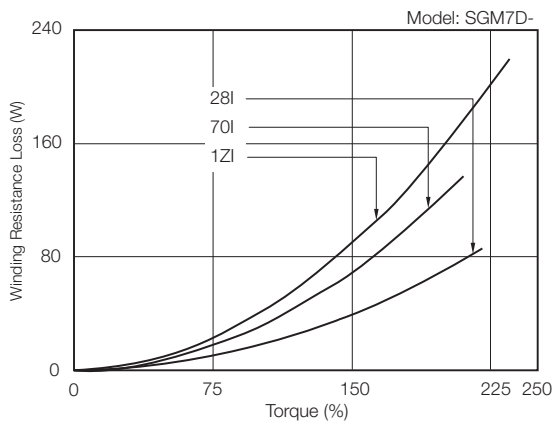
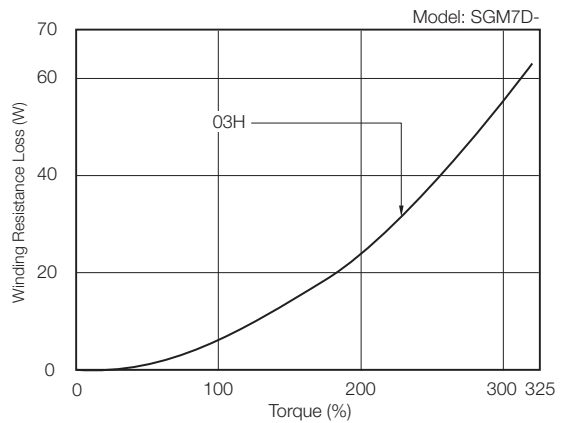
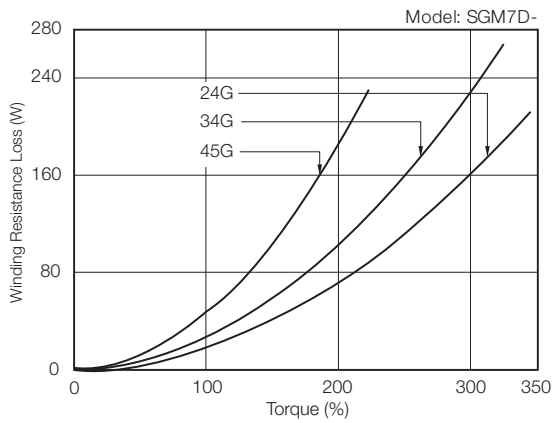
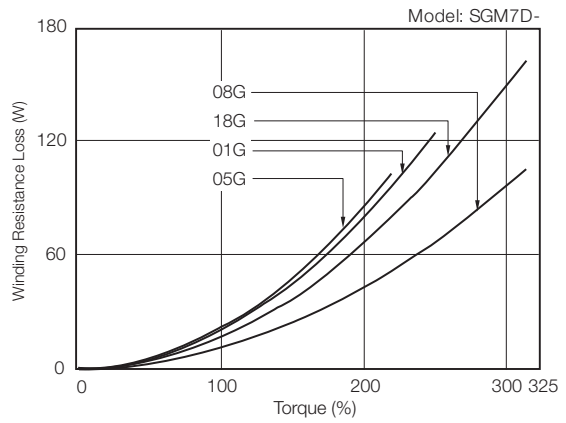
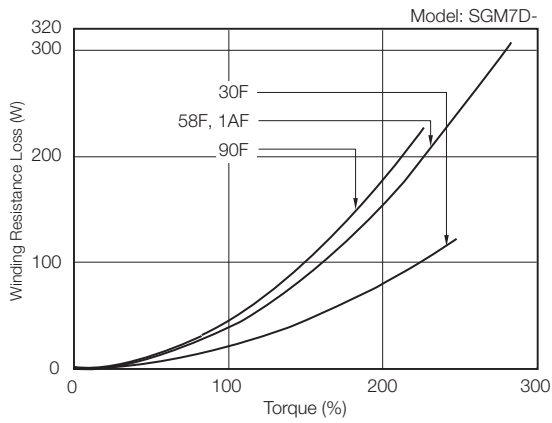

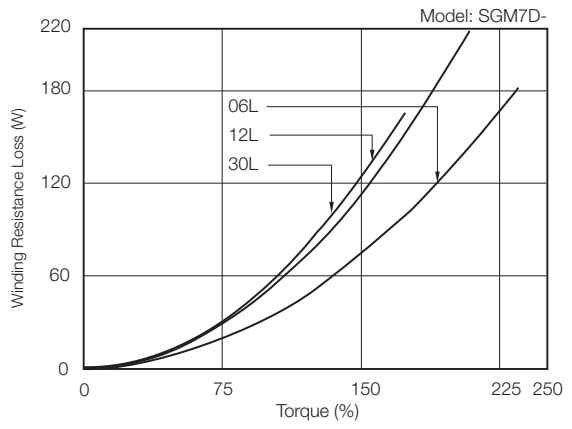
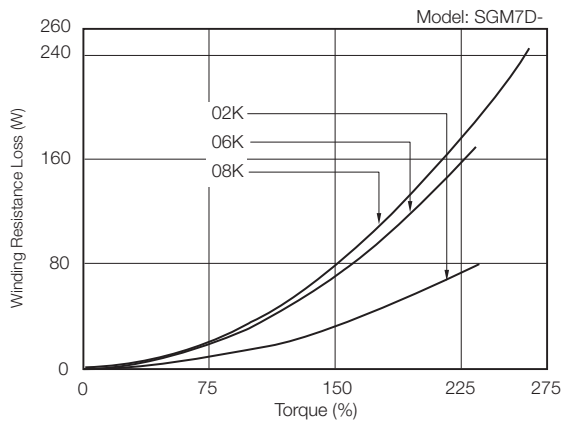
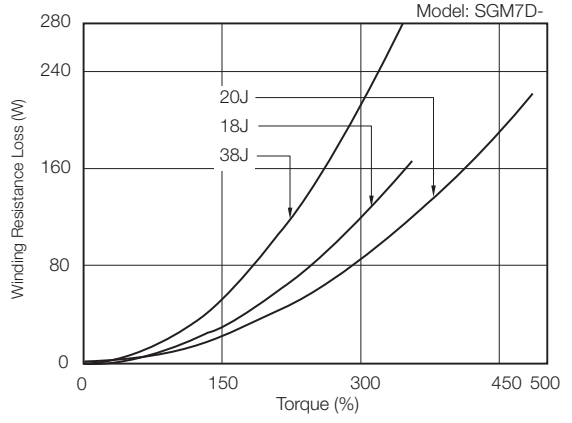
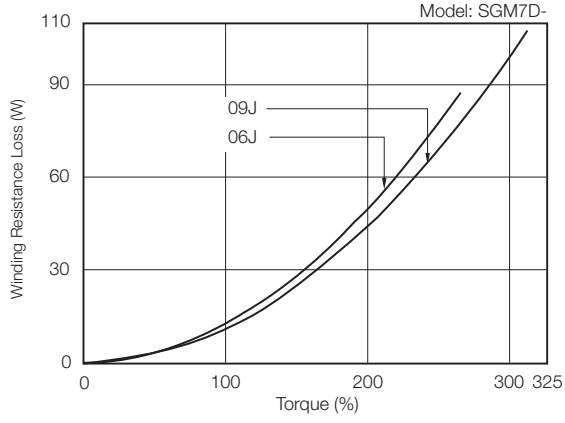

■ SGM7E Direct Drive Servomotors

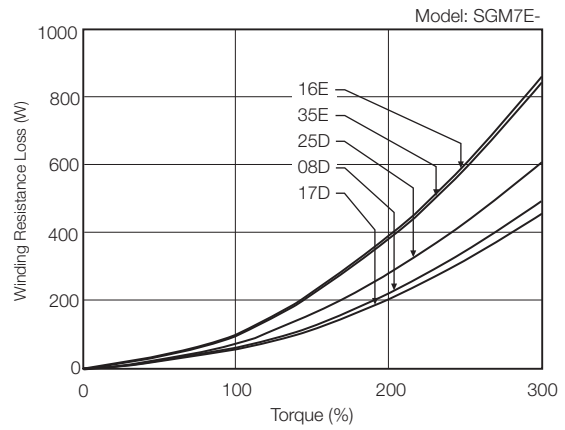
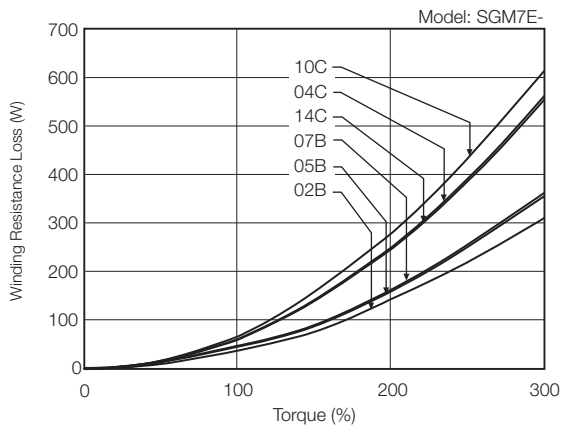

■ SGM7F Direct Drive Servomotors

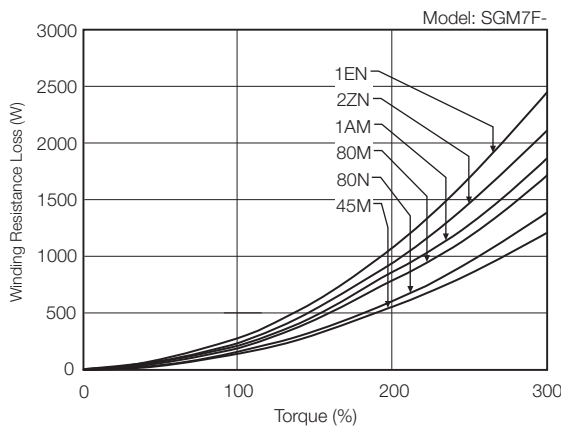
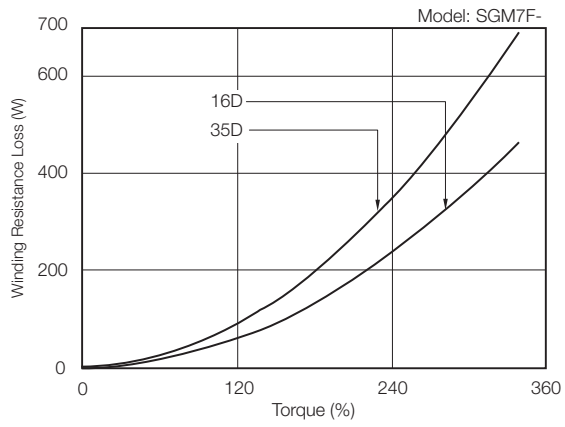
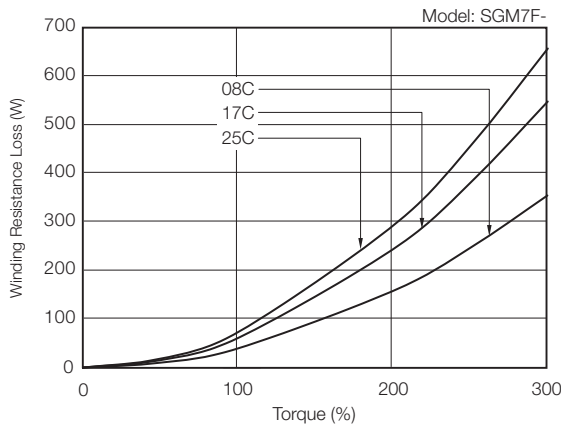
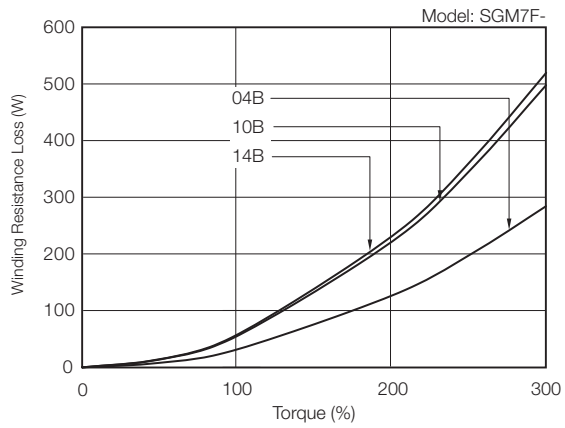
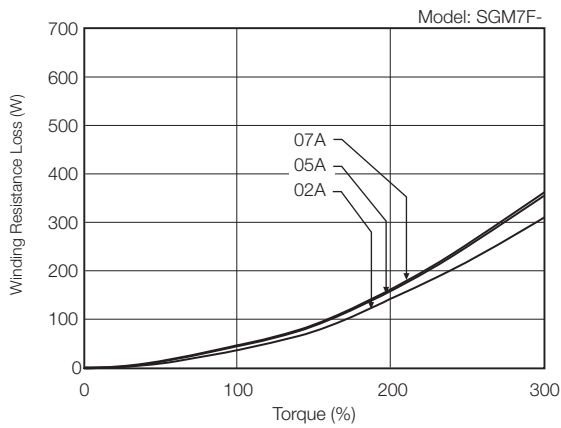

■ SGMCV Direct Drive Servomotors

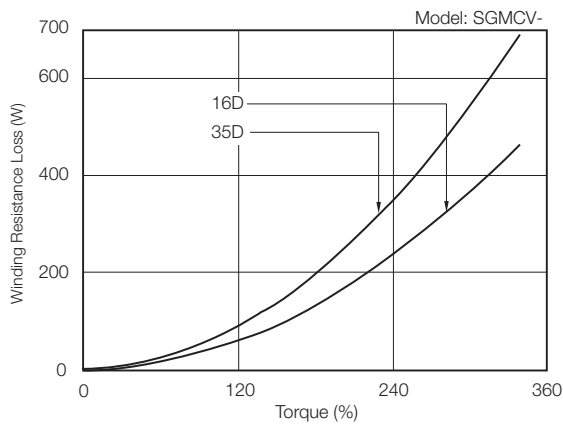
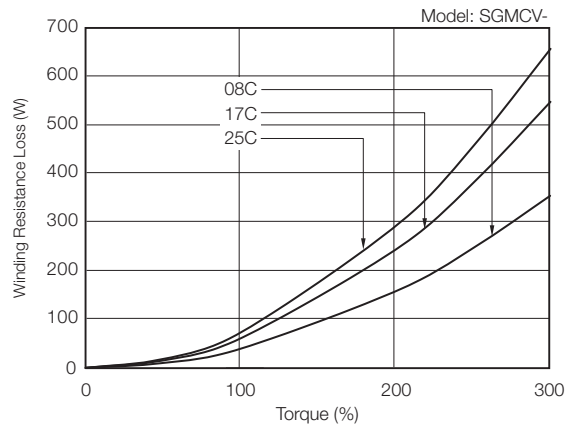
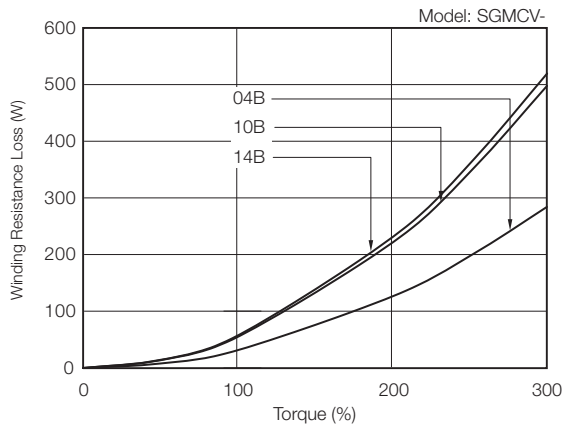

■ SGMCS Direct Drive Servomotors

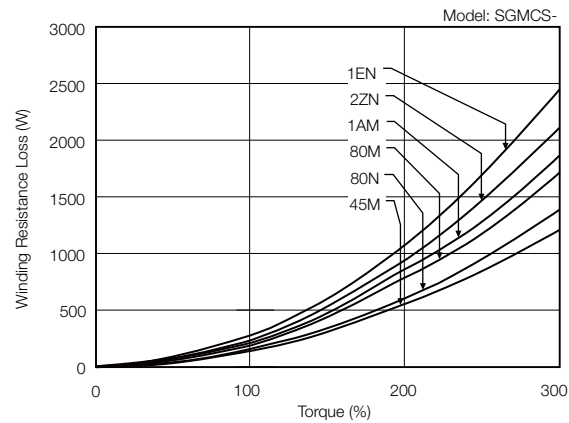
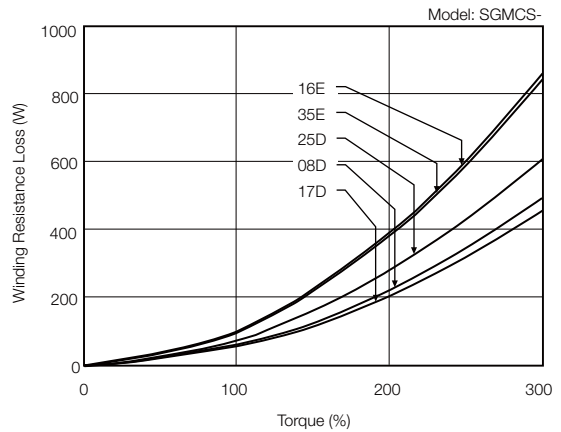
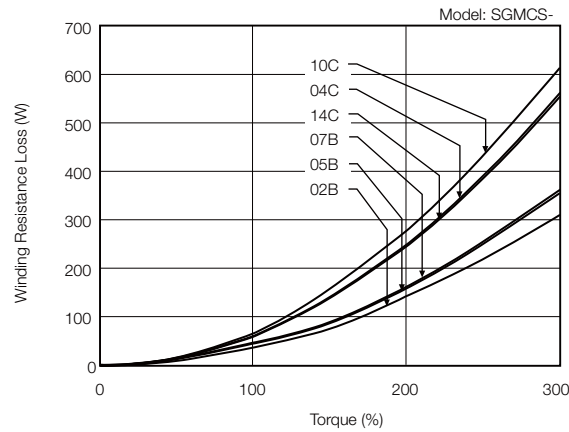

■ SGLGW Linear Servomotors

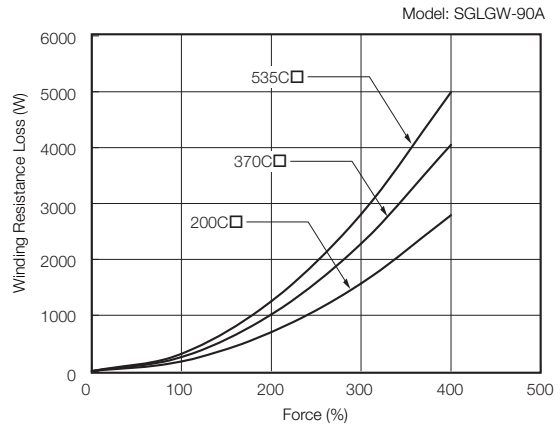
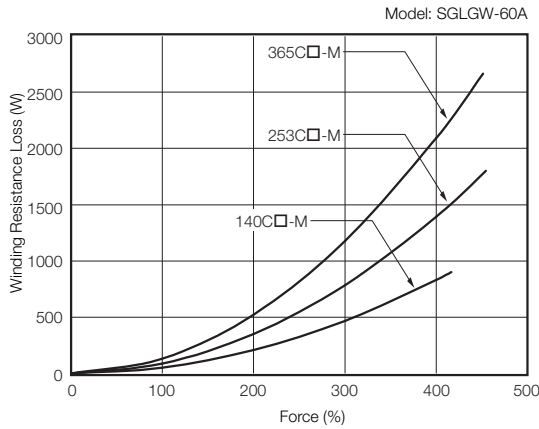
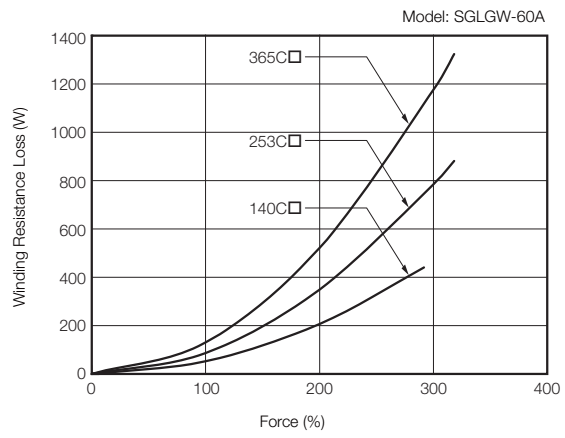
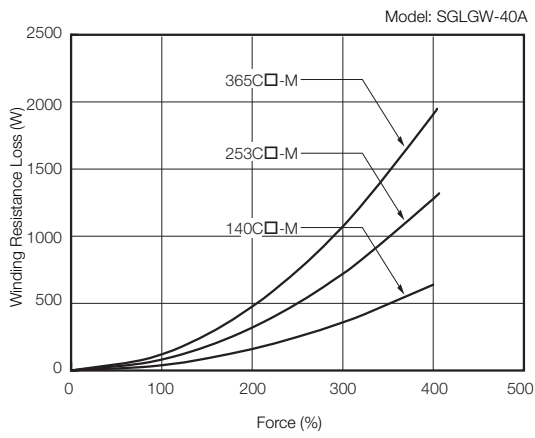
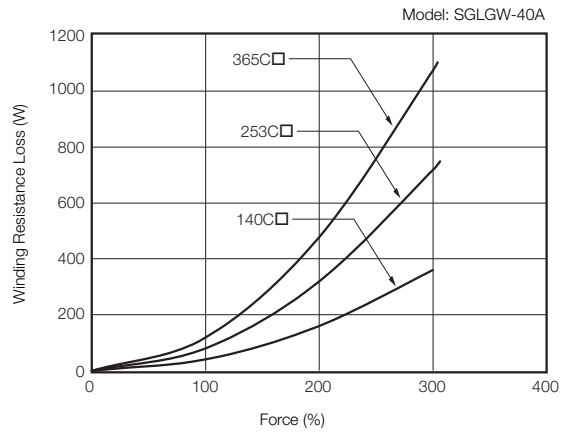
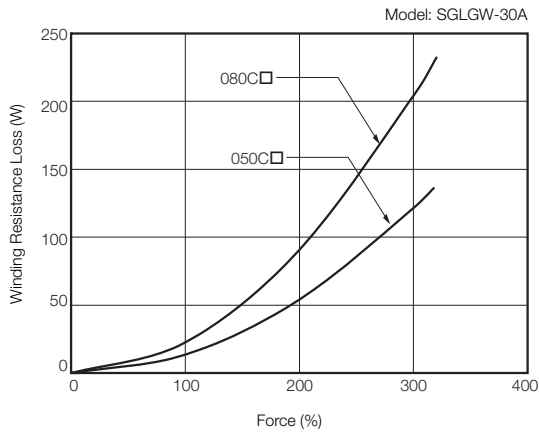

■ SGLFW2 Linear Servomotors

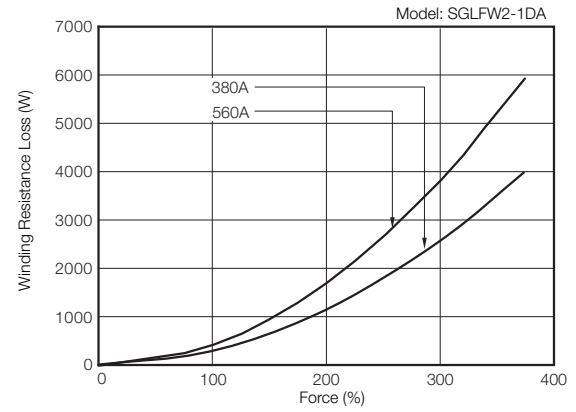
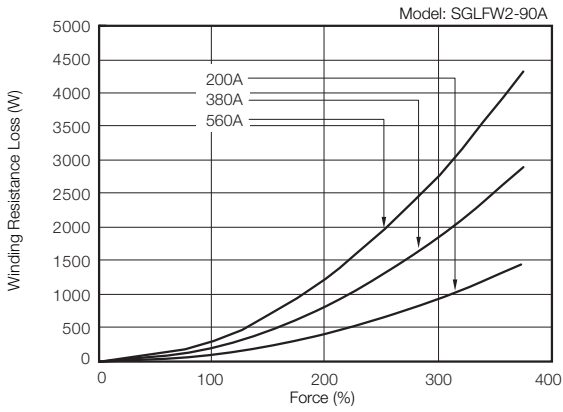
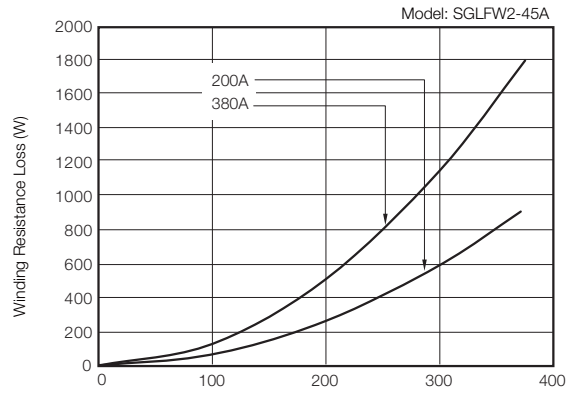
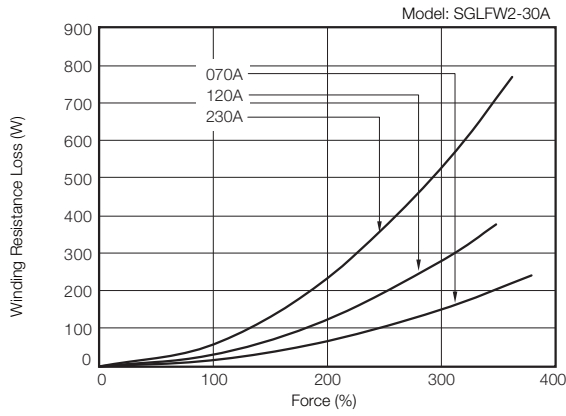

■ SGLFW Linear Servomotors

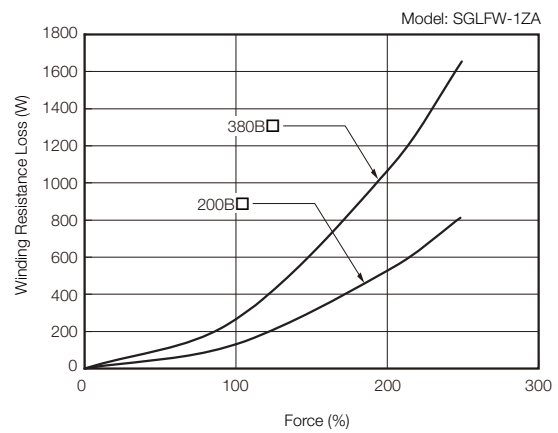
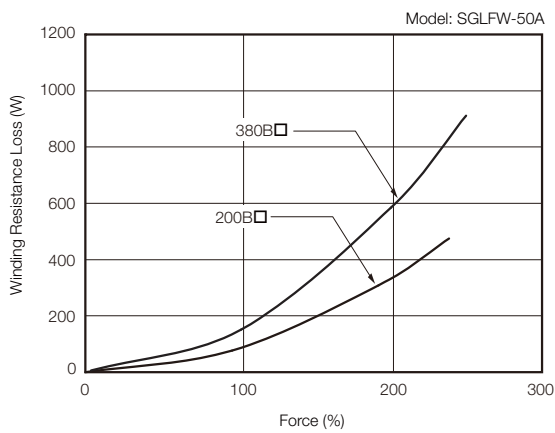
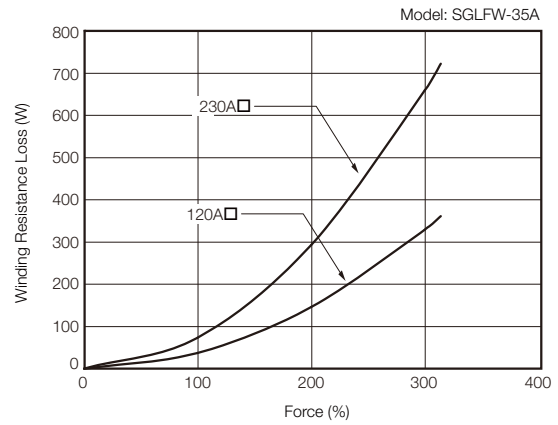
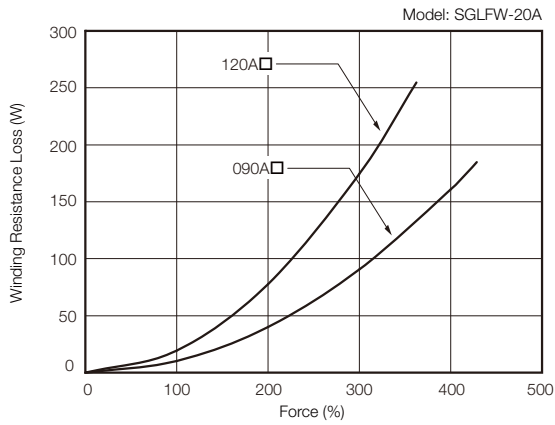

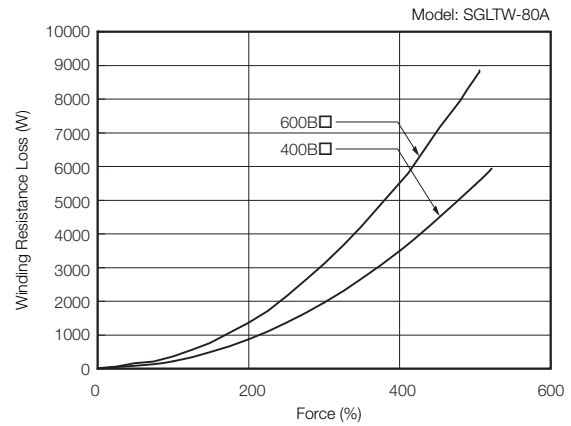
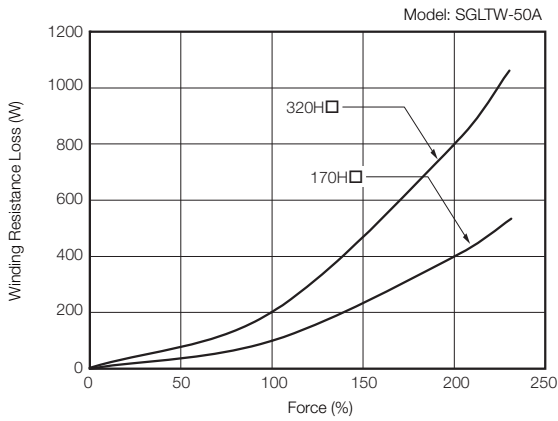
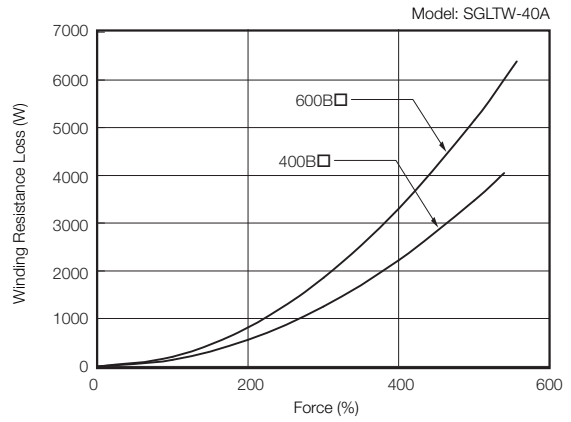
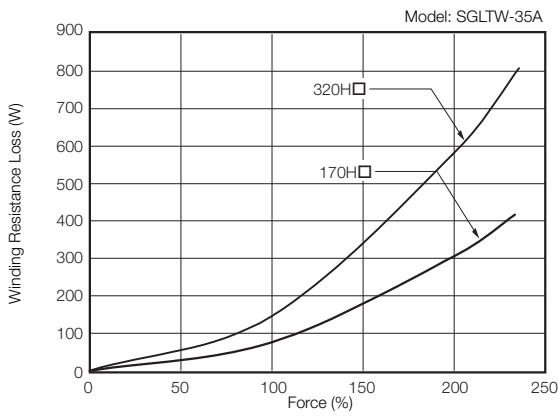
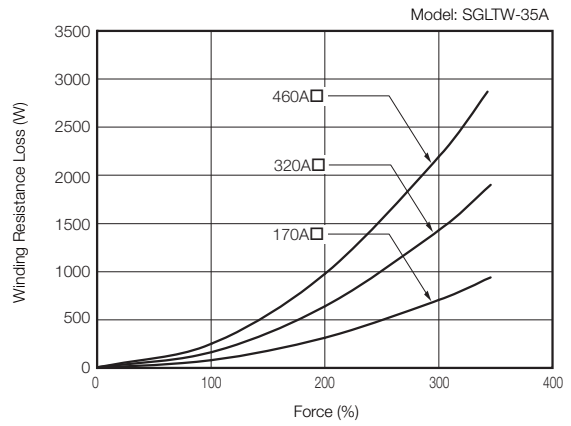
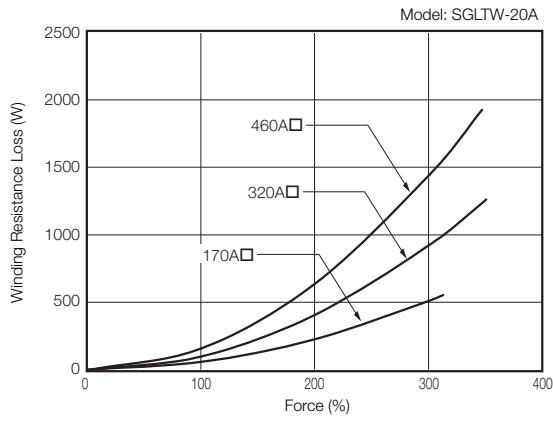

■ SGLTW Linear Servomotors





International Standards

● : Certified, – : Not Certified

Product	Model	UL/CSA Standards	CE Marking	KC Mark	RoHS Directive
					
SERVOPACKs	SGD7S	●	●	●	●
	SGD7W	●	●	●	●
	SGD7C	●	●	●	●
Communications Options	INDEXER Module	SGDV-OCA03A*	●	●	●
	DeviceNet Module	SGDV-OCA04A*, OCA05A*	●	●	●
Feedback Option	Fully-Closed Module	SGDV-OFA01A*	●	●	●
Safety Option	Safety Module	SGDV-OSA01A*	●	●	●

* Use this model number to purchase the Option Module separately.

Product	Model	UL/CSA Standards	CE Marking	RoHS Directive
				
Rotary Servomotors	SGMMV	●	●	●
	SGM7J	●	●	●
	SGM7A	●	●	●
	SGM7P	●	●	●
	SGM7G	●	●	●
Direct Drive Servomotors	SGM7D	–	●	●
	SGM7E	Certification is pending.	Certification is pending.	●
	SGM7F	●	Certification is pending.	●
	SGMCS	–	*2	●*1
	SGM7G	●	●	●
Linear Servomotors	SGLGW (SGLGM)*3	●	*4	●*1
	SGLFW2 (SGLFM2)*3	●*5	●	●
	SGLFW (SGLFM)*3	●	*4	●*1
	SGLTW (SGLTM)*3	●	*4	●*1

*1. Estimates are provided for RoHS-compliant products. The model numbers have an “-E” suffix.

*2. CE Marking certification has not yet been received for SGMCS-□□M and SGMCS-□□N Direct Drive Servomotors.

CE Marking certification has been received for the following Direct Drive Servomotors: SGMCS-□□B, SGMCS-□□C, SGMCS-□□D, and SGMCS-□□E. Contact your Yaskawa representative if the CE Marking label is required.

*3. The model numbers of the Magnetic Ways of Linear Servomotors are given in parentheses.

*4. CE Marking certification has been received. Contact your Yaskawa representative if the CE Marking label is required.

*5. UL certification has not yet been received for SGLFW2-□□□560A Linear Servomotors.

MEMO

Warranty

◆ Details of Warranty

■ Warranty Period

The warranty period for a product that was purchased (hereinafter called "delivered product") is one year from the time of delivery to the location specified by the customer or 18 months from the time of shipment from the Yaskawa factory, whichever is sooner.

■ Warranty Scope

Yaskawa shall replace or repair a defective product free of charge if a defect attributable to Yaskawa occurs during the above warranty period. This warranty does not cover defects caused by the delivered product reaching the end of its service life and replacement of parts that require replacement or that have a limited service life.

This warranty does not cover failures that result from any of the following causes.

- Improper handling, abuse, or use in unsuitable conditions or in environments not described in product catalogs or manuals, or in any separately agreed-upon specifications
- Causes not attributable to the delivered product itself
- Modifications or repairs not performed by Yaskawa
- Use of the delivered product in a manner in which it was not originally intended
- Causes that were not foreseeable with the scientific and technological understanding at the time of shipment from Yaskawa
- Events for which Yaskawa is not responsible, such as natural or human-made disasters

◆ Limitations of Liability

- Yaskawa shall in no event be responsible for any damage or loss of opportunity to the customer that arises due to failure of the delivered product.
- Yaskawa shall not be responsible for any programs (including parameter settings) or the results of program execution of the programs provided by the user or by a third party for use with programmable Yaskawa products.
- The information described in product catalogs or manuals is provided for the purpose of the customer purchasing the appropriate product for the intended application. The use thereof does not guarantee that there are no infringements of intellectual property rights or other proprietary rights of Yaskawa or third parties, nor does it construe a license.
- Yaskawa shall not be responsible for any damage arising from infringements of intellectual property rights or other proprietary rights of third parties as a result of using the information described in catalogs or manuals.

◆ Suitability for Use

- It is the customer's responsibility to confirm conformity with any standards, codes, or regulations that apply if the Yaskawa product is used in combination with any other products.
- The customer must confirm that the Yaskawa product is suitable for the systems, machines, and equipment used by the customer.
- Consult with Yaskawa to determine whether use in the following applications is acceptable. If use in the application is acceptable, use the product with extra allowance in ratings and specifications, and provide safety measures to minimize hazards in the event of failure.
 - Outdoor use, use involving potential chemical contamination or electrical interference, or use in conditions or environments not described in product catalogs or manuals
 - Nuclear energy control systems, combustion systems, railroad systems, aviation systems, vehicle systems, medical equipment, amusement machines, and installations subject to separate industry or government regulations
 - Systems, machines, and equipment that may present a risk to life or property
 - Systems that require a high degree of reliability, such as systems that supply gas, water, or electricity, or systems that operate continuously 24 hours a day
 - Other systems that require a similar high degree of safety
- Never use the product for an application involving serious risk to life or property without first ensuring that the system is designed to secure the required level of safety with risk warnings and redundancy, and that the Yaskawa product is properly rated and installed.
- The circuit examples and other application examples described in product catalogs and manuals are for reference. Check the functionality and safety of the actual devices and equipment to be used before using the product.
- Read and understand all use prohibitions and precautions, and operate the Yaskawa product correctly to prevent accidental harm to third parties.

◆ Specifications Change

The names, specifications, appearance, and accessories of products in product catalogs and manuals may be changed at any time based on improvements and other reasons. The next editions of the revised catalogs or manuals will be published with updated code numbers. Consult with your Yaskawa representative to confirm the actual specifications before purchasing a product.

Σ-7 SERIES

IRUMA BUSINESS CENTER (SOLUTION CENTER)

480, Kamifujisawa, Iruma, Saitama, 358-8555, Japan
Phone 81-4-2962-5151 Fax 81-4-2962-6138
<http://www.yaskawa.co.jp>

YASKAWA AMERICA, INC.

2121, Norman Drive South, Waukegan, IL 60085, U.S.A.
Phone 1-800-YASKAWA (927-5292) or 1-847-887-7000 Fax 1-847-887-7310
<http://www.yaskawa.com>

YASKAWA ELÉTRICO DO BRASIL LTDA.

777, Avenida Piraporinha, Diadema, São Paulo, 09950-000, Brasil
Phone 55-11-3585-1100 Fax 55-11-3585-1187
<http://www.yaskawa.com.br>

YASKAWA EUROPE GmbH

185, Hauptstraße, Eschborn, 65760, Germany
Phone 49-6196-569-300 Fax 49-6196-569-398
<http://www.yaskawa.eu.com>

YASKAWA ELECTRIC KOREA CORPORATION

35F, Three IFC, 10 Gukjegeumyung-ro, Yeongdeungpo-gu, Seoul, 07326, Korea
Phone 82-2-784-7844 Fax 82-2-784-8495
<http://www.yaskawa.co.kr>

YASKAWA ELECTRIC (SINGAPORE) PTE. LTD.

151, Lorong Chuan, #04-02A, New Tech Park 556741, Singapore
Phone 65-6282-3003 Fax 65-6289-3003
<http://www.yaskawa.com.sg>

YASKAWA ELECTRIC (THAILAND) CO., LTD.

59, 1st-5th Floor, Flourish Building, Soi Ratchadapisek 18, Ratchadapisek Road, Huaykwang, Bangkok 10310, Thailand
Phone: +66-2-017-0099 Fax: +66-2-017-0799
<http://www.yaskawa.co.th>

YASKAWA ELECTRIC (CHINA) CO., LTD.

22F, One Corporate Avenue, No.222, Hubin Road, Shanghai, 200021, China
Phone 86-21-5385-2200 Fax 86-21-5385-3299
<http://www.yaskawa.com.cn>

YASKAWA ELECTRIC (CHINA) CO., LTD. BEIJING OFFICE

Room 1011, Tower W3 Oriental Plaza, No.1, East Chang An Ave.,
Dong Cheng District, Beijing, 100738, China
Phone 86-10-8518-4086 Fax 86-10-8518-4082

YASKAWA ELECTRIC TAIWAN CORPORATION

9F, 16, Nanking E. Rd., Sec. 3, Taipei, 104, Taiwan
Phone 886-2-2502-5003 Fax 886-2-2505-1280
<http://www.yaskawa-taiwan.com.tw>

YASKAWA**YASKAWA ELECTRIC CORPORATION**

In the event that the end user of this product is to be the military and said product is to be employed in any weapons systems or the manufacture thereof, the export will fall under the relevant regulations as stipulated in the Foreign Exchange and Foreign Trade Regulations. Therefore, be sure to follow all procedures and submit all relevant documentation according to any and all rules, regulations and laws that may apply. Specifications are subject to change without notice for ongoing product modifications and improvements.

© 2014-2016 YASKAWA ELECTRIC CORPORATION

LITERATURE NO. KAEP S800001 23F <5>-0

Published in Japan December 2016
16-8-16